



HENRY PARK PRIMARY SCHOOL

SEMESTRAL EXAMINATION II

2007

SCIENCE

PRIMARY 3

BOOKLET A

Name: _____ ()

Class: Primary 3 _____

**30 Questions
60 Marks**

Total Time for Booklets A and B: 1 h 30 min

DO NOT OPEN THIS BOOKLET UNTIL YOU ARE TOLD TO DO SO.

READ AND FOLLOW INSTRUCTIONS CAREFULLY.

PART 1 (60 marks)

For each question from 1 to 30, four options are given. One of them is the correct answer. Make your choice (1,2, 3 or 4). Shade the correct oval (1,2,3 or 4) on the Optical Answer Sheet.

1 Ben's mum has just given birth. Which characteristic of a living thing does this show?

- (1) Living things need to reproduce.
- (2) Living things move by themselves.
- (3) Living things need air, water and food.
- (4) Living things die quickly without water or air. ()

2 Study the table below.

Group A	Group B	Group C
giraffe	ostrich	lobster
monkey	flamingo	hermit crab
cat	eagle	oyster

The above animals are grouped according to _____.

- (1) what they eat
- (2) where they live
- (3) how they reproduce
- (4) their outer coverings ()

3 Which of the statements below is **FALSE**?

- (1) All insects eat only plants.
- (2) All insects have three pairs of legs.
- (3) All insects reproduce by laying eggs.
- (4) All insects have feelers on their heads. ()

- 4 The diagram below, not drawn to scale, shows a leaf measured against a ruler.

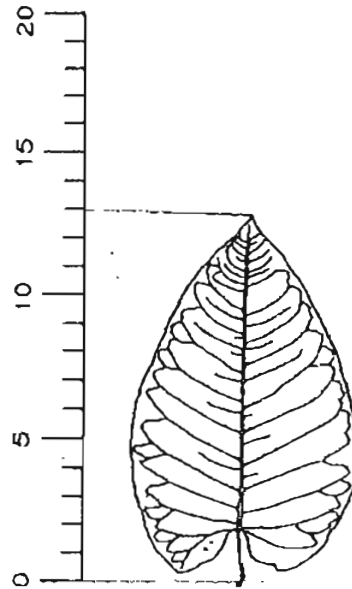

What is the length of the leaf?

- (1) 12cm
- (2) 13cm
- (3) 14cm
- (4) 15cm

()

5 Identify the parts of the plant below. Which of the following represents the parts correctly?

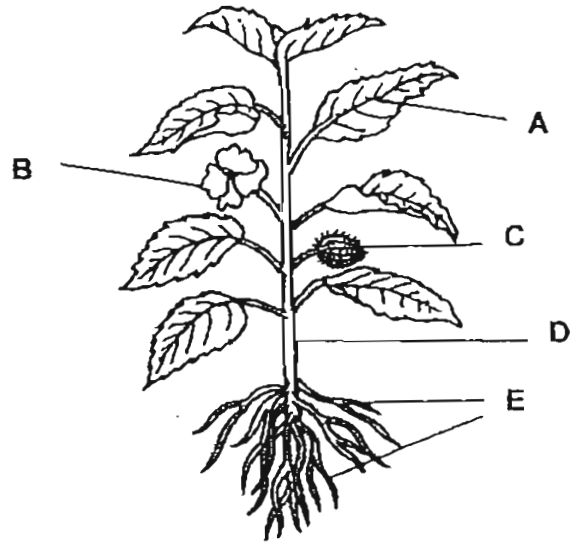

	Root	Stem	Leaf	Flower	Fruit
(1)	E	D	B	C	A
(2)	A	B	C	E	D
(3)	E	D	A	B	C
(4)	D	E	A	B	C

6 The flow chart below shows the characteristics of some plants. Study it carefully and answer the question that follows.

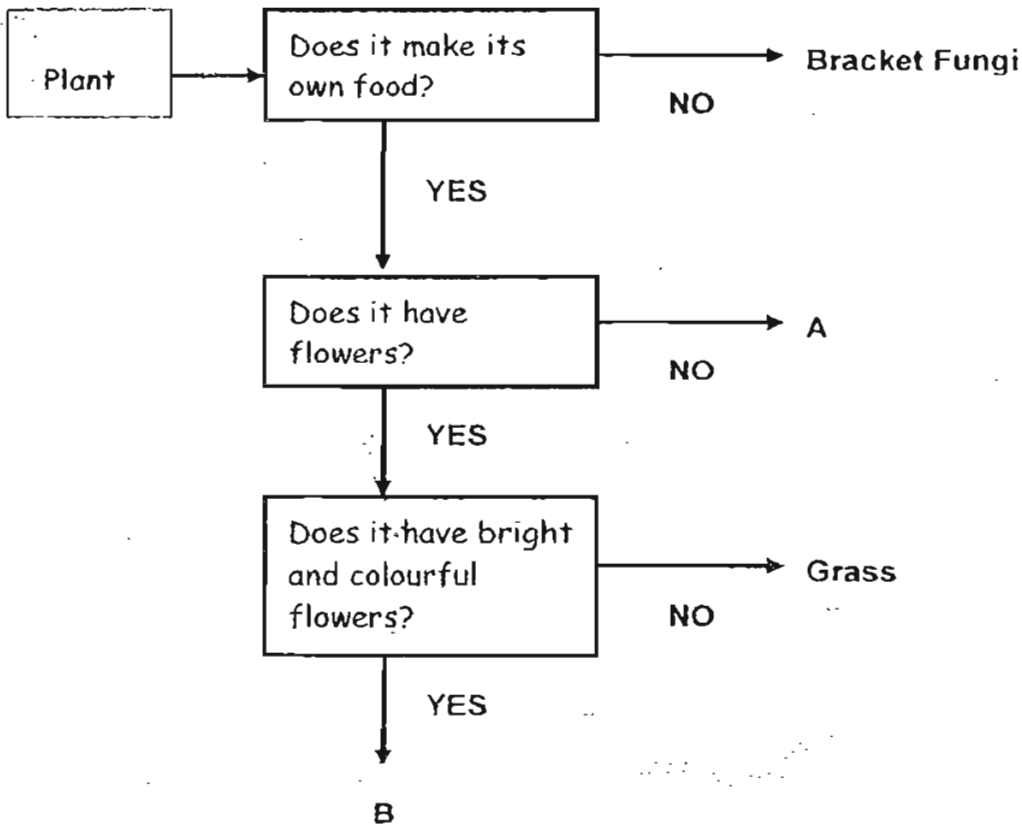

Which features best describe Plant A and Plant B?

	Plant A	Plant B
(1)	It will not bear fruits	It will bear fruits
(2)	It is not a green plant	It is a green plant
(3)	It is a flowering plant	It is a non-flowering plant
(4)	It reproduces by seeds	It reproduces by spores

7 The object below is made from rubber. What other possible materials can be used to make the object?



glove

- A: Glass
- B: Plastic
- C: Cloth
- D: Metal

- (1) A and C only
- (2) B and C only
- (3) B and D only
- (4) A, B and C only

()

8 The picture below shows a pair of spectacles.

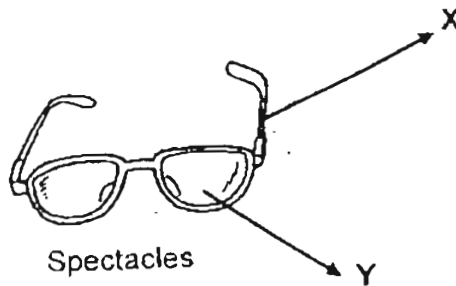

Spectacles

What are X and Y likely to be?

	X	Y
(1)	Glass	Metal
(2)	Metal	Glass
(3)	Wood	Plastic
(4)	Cotton	Rubber

()

9 The table below describes the stages of the life cycles of four animals. Study it and answer the following question.

Description	Animal W	Animal X	Animal Y	Animal Z
Young resembles the adult	√	X	√	X
Has three stages in its life cycle	√	X	X	√
The young goes through a process called moulting	X	√	X	√

Which of the following is likely to be a beetle?

- (1) Animal W
- (2) Animal X
- (3) Animal Y
- (4) Animal Z

()

10 Which diagram below shows the life cycle of a butterfly?

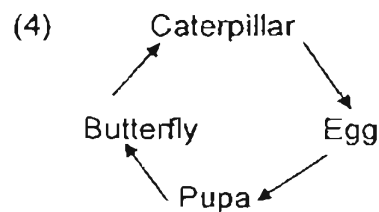
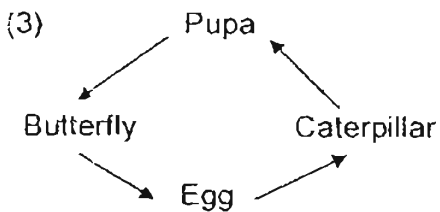
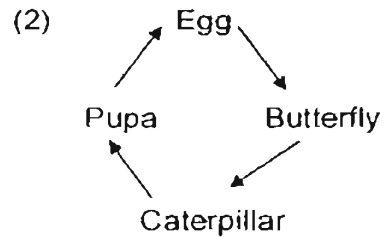
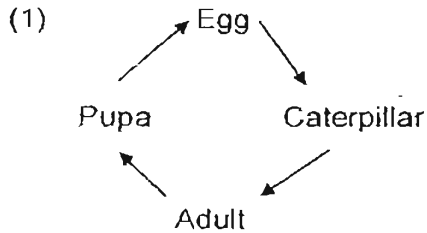

- (1) 1
- (2) 2
- (3) 3
- (4) 4

()

11 Which statement below best describes the similarities between the caterpillar and the cockroach nymph?

- (1) Both eat only leaves
- (2) Both come from an egg.
- (3) Both are protected by a hard covering.
- (4) Both will change into a pupa before they become adults. ()

12 Which of the young below look like their parents?

(1)



Tadpole

(2)



Mealworm

(3)

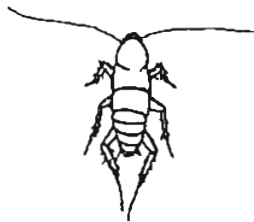

Cockroach nymph

(4)



Wiggler

()

- 13 Sarah conducted an experiment to find out whether the amount of water will affect the growth of seeds. She placed a few seeds in each of the four containers.

The table below shows the amount of water that Sarah used to water the plants each day. It also shows which containers receive air and sunlight.

Container	Amount of water (ml)	Air	Sunlight
A	5 ml	√	√
B	10 ml	√	√
C	5 ml	√	X
D	15 ml	X	√

Which containers should she use if she wants to find out whether the amount of water will affect the growth of seeds?

- (1) Containers A and B
- (2) Containers A and C
- (3) Containers B and C
- (4) Containers B and D

()

The diagram below shows a living thing. Study it and answer questions 14 and 15.

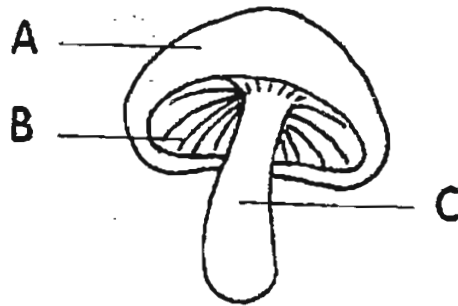

14 Which part(s) of the living thing above is/are responsible for its reproduction?

- (1) A only
- (2) B only
- (3) B and C only
- (4) A and B only

()

15 What can be found in the part(s) that is/are responsible for its reproduction?

- (1) Seeds
- (2) Spores
- (3) Fruits
- (4) Roots

()

16 The chart below shows the number of fishes found in a pond over 4 years.

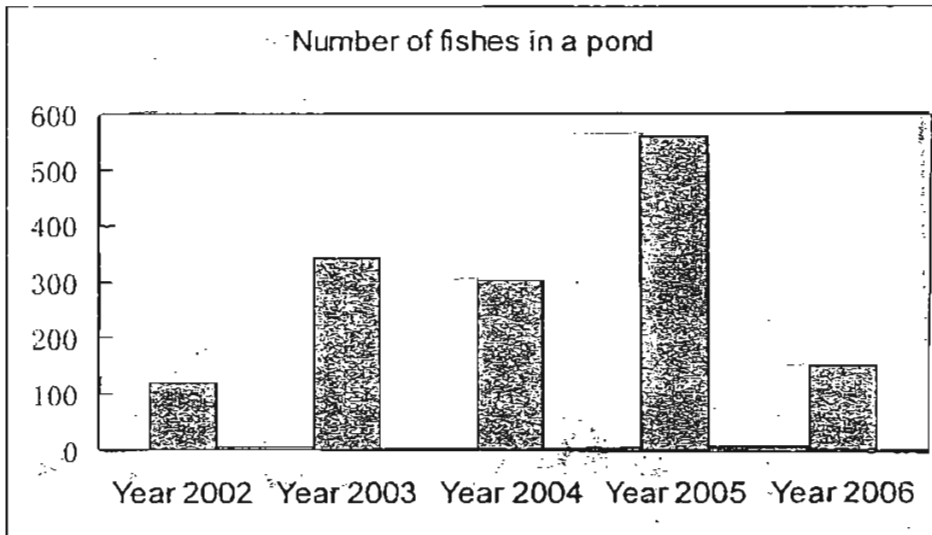

A deadly virus once spread through the pond and killed many fishes. Which of the following best shows the period it happened?

- (1) Between Year 2002 and 2003
- (2) Between Year 2003 and 2004
- (3) Between Year 2004 and 2005
- (4) Between Year 2005 and 2006

17 "It's time for my favourite television programme!" Peter exclaimed as he sat in front of the television.

What are the **sense organs** that he is using below?

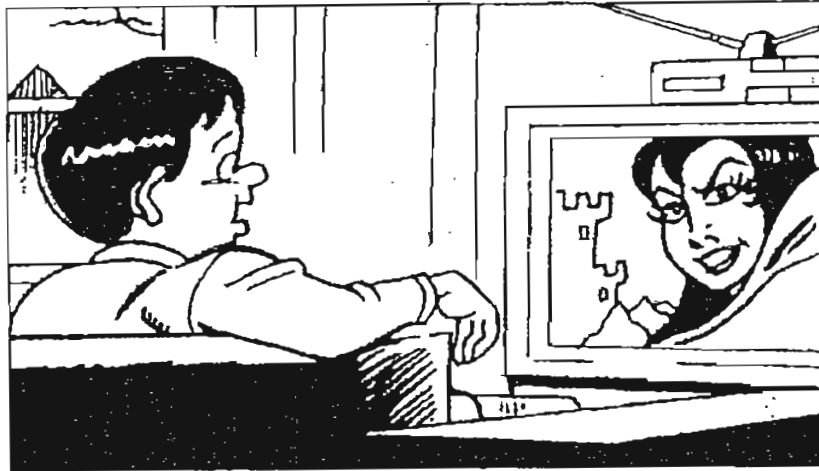

- A: Ears
- B: Eyes
- C: Nose

- (1) B only
- (2) C only
- (3) A and B only
- (4) A and C only

18 Four children were asked to observe some objects. Below are the observations they made.

Child	Observation
John	The red apple is sweet and juicy.
Xiaoting	The rubber ball is bouncy.
Siti	The silver bell made a loud noise.
Gautam	The muffin is delicious and smells good.

Which of the following correctly shows the senses that the child has used?

	Child	Sight	Hearing	Smell	Taste	Touch
(1)	John				✓	
(2)	Xiaoting	✓			✓	✓
(3)	Siti	✓	✓			
(4)	Gautam	✓		✓		

19 The human system shown below is our _____ system.

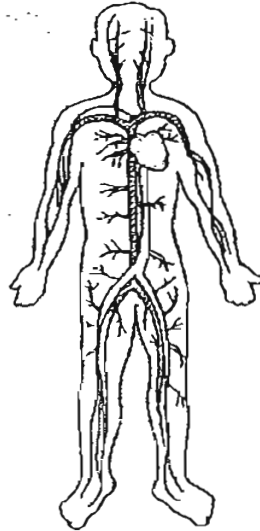

- (1) skeletal
- (2) muscular
- (3) circulatory
- (4) respiratory

()

20 The following diagram shows the different organs of a human digestive system.

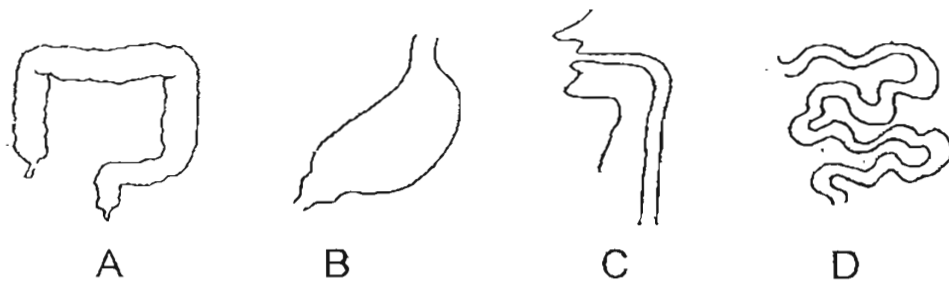

Which of the following shows the correct path our food takes during digestion?

- (1) C → B → D → A
- (2) C → D → B → A
- (3) C → B → A → D
- (4) C → A → B → D

()

21 The following plants are placed in the sunlight and given water every day.

Which plant(s) will not be able to survive past one week?

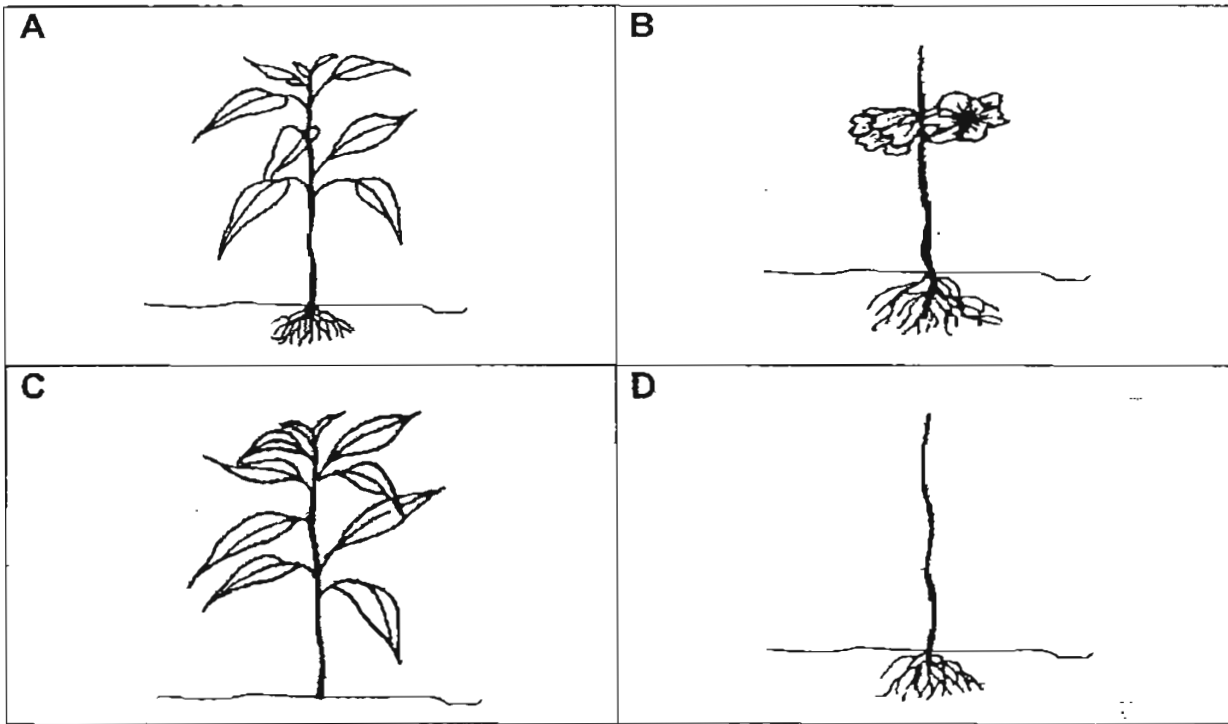

- (1) A only
- (2) B and D only
- (3) A, C and D only
- (4) B, C and D only

()

22 Study the plant below.

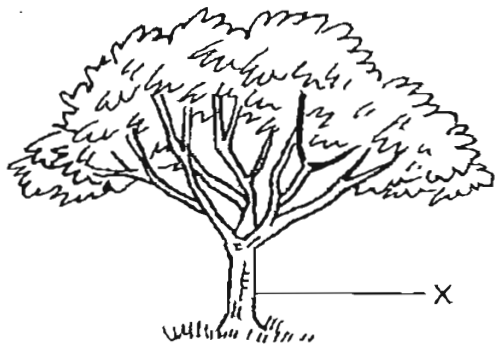

Which of the following is **NOT** a function of the part labelled X?

- (1) It holds the plant upright.
- (2) It transports food to the roots.
- (3) It helps the plant absorb water.
- (4) It transports water to the leaves.

()

23 Look at the diagram of the plant below carefully.

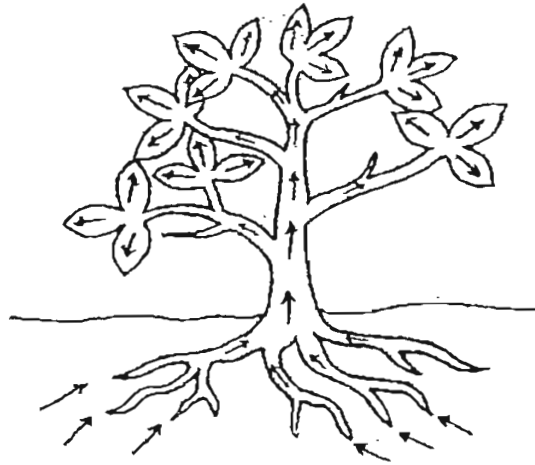

The arrows show the path taken by _____.

- A: air
- B: sugar
- C: water
- D: mineral salts

- (1) A and B only
- (2) A and C only.
- (3) B and D only.
- (4) C and D only.

()

24 Study the magnets below.

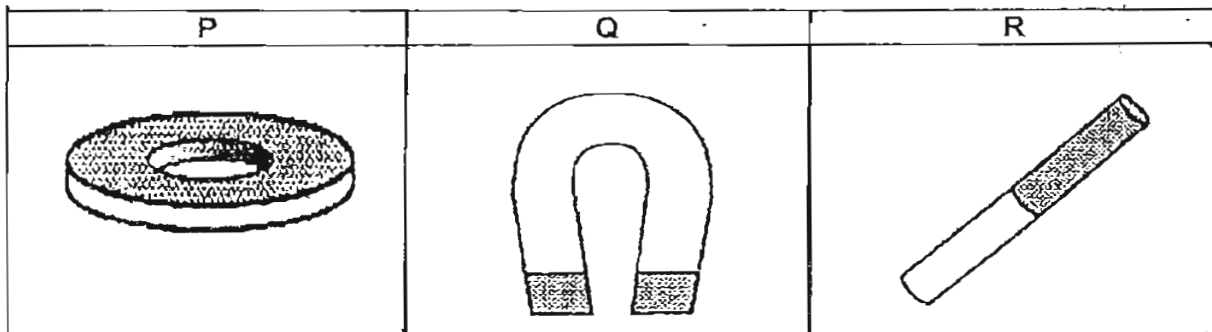

What of the following is correct?

- | | P | Q | R |
|-----|---------------|------------------|------------|
| (1) | Ring magnet | U-shaped magnet | Rod magnet |
| (2) | Button magnet | U-shaped magnet | Bar magnet |
| (3) | Ring magnet | Horseshoe magnet | Rod magnet |
| (4) | Button magnet | Horseshoe magnet | Bar magnet |

()

25 Nancy carried out an experiment on 3 objects with a magnet to find out how the objects would respond. Below are her results. (✓ - Yes X - No)

Object	Attracted to magnet	Repelled by magnet
A	✓	X
B	X	X
C	✓	✓

What could objects A, B and C be?

	A	B	C
(1)	Magnet	Handkerchief	Paper Clip
(2)	Paper Clip	Magnet	Handkerchief
(3)	Paper Clip	Handkerchief	Magnet
(4)	Handkerchief	Paper Clip	Magnet

26 When four bar magnets were brought near to each other as shown below, they attracted each other.

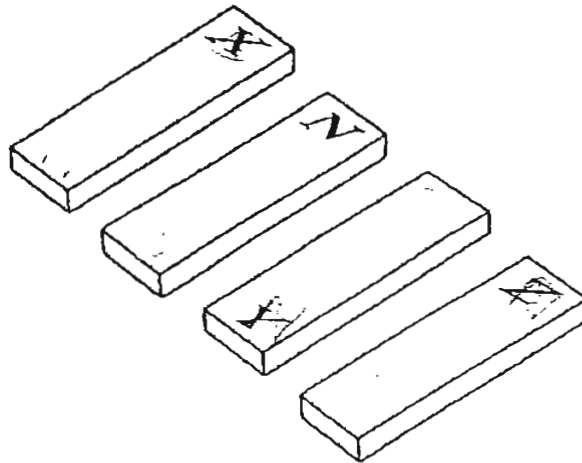

If N is the North pole, what are the unknown poles, X, Y and Z?

	Pole X	Pole Y	Pole Z
(1)	South Pole	South Pole	North Pole
(2)	North Pole	North Pole	North Pole
(3)	North Pole	South Pole	North Pole
(4)	South Pole	North Pole	North Pole

27 The diagram shows what was observed when a magnet was brought close to an object.

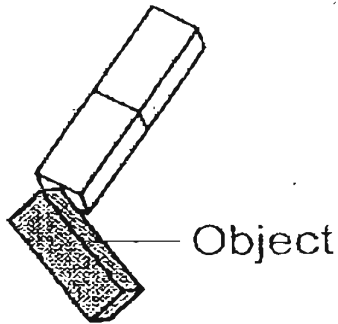

What could the object be made of?

- (1) Gold
- (2) Steel
- (3) Copper
- (4) Aluminium

()

28 Which of the following is the correct method of making a magnet out of an iron nail by stroking?

<p>(1)</p>	<p>(2)</p>
<p>(3)</p>	<p>(4)</p>

()

29 Which of the following metal bars will become an electromagnet when the switch is turned on?

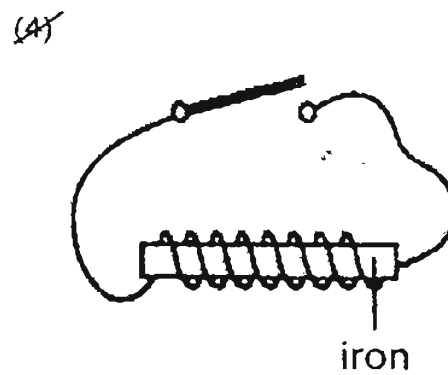
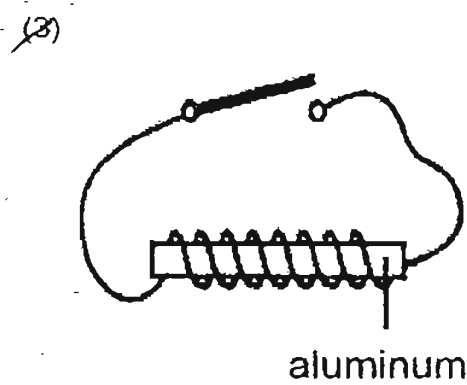
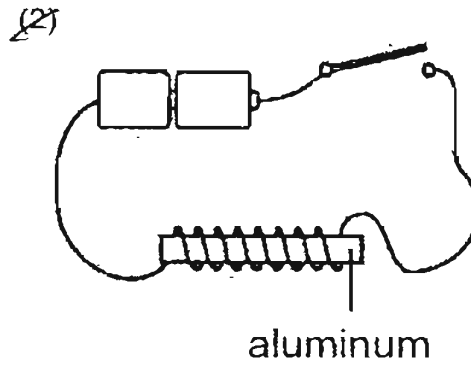
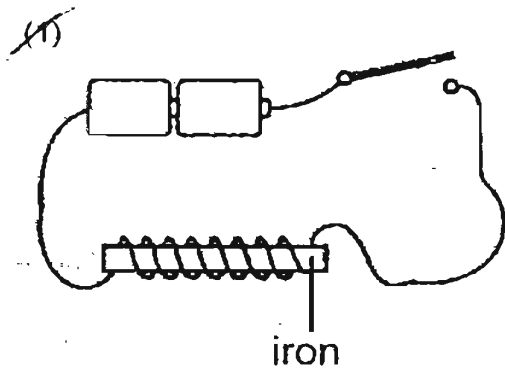

()

30 Which of the following **DOES NOT** make use of magnets to work?

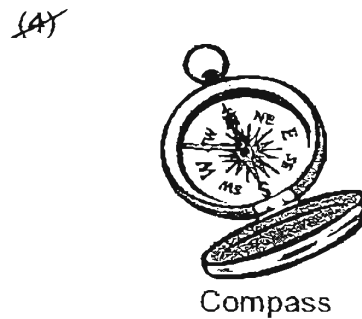
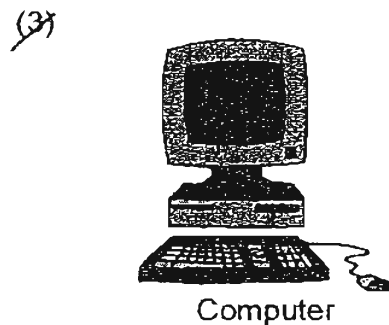
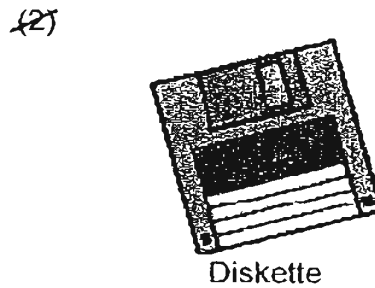
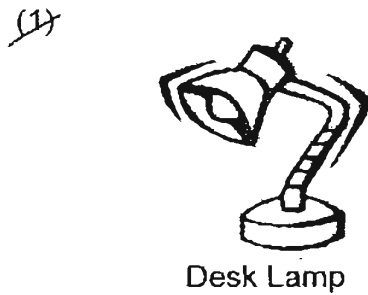

()



HENRY PARK PRIMARY SCHOOL

SEMESTRAL EXAMINATION II

2007

SCIENCE

PRIMARY 3

BOOKLET B

Name: _____ ()

Class: Primary 3 _____

**16 Questions
40 Marks**

Total Time for Booklets A and B: 1 h 30 min

DO NOT OPEN THIS BOOKLET UNTIL YOU ARE TOLD TO DO SO.

READ AND FOLLOW INSTRUCTIONS CAREFULLY.

PART 2 (40 marks)

Write your answers to questions 31 to 46 in the spaces given.

31 Sally placed 2 things A and B in separate cages with food and water.

She then observed their mass over a period of 4 weeks and recorded her findings below.

	Mass of A	Mass of B
Week 1	3 kg	2 kg
Week 2	5 kg	2 kg
Week 3	7 kg	2 kg
Week 4	9 kg	2 kg

(a) Which one, A or B, is more likely to be a living thing? (1m)

(b) By week 5, what will be the possible mass of A and B? (1m)

(i) A : _____ kg

(ii) B : _____ kg

32 Su Lin, Ramesh and Siti were each given a set of 8 buttons as shown below.

Their Science Teacher, Mrs Leong, asked each pupil to classify them in a different way from the rest.

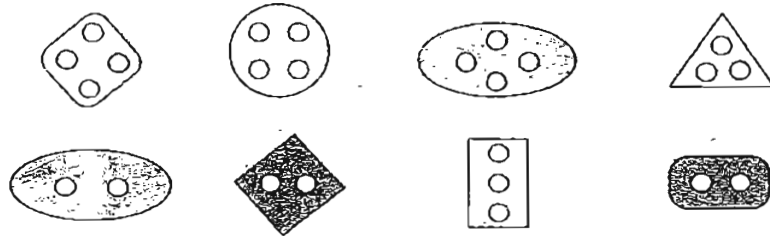

The tables below show how each pupil classified the 8 buttons.

Siti's classification of the buttons		

Ramesh's classification of the buttons		

Su Lin's classification of the buttons	

(a) How did Ramesh classify the buttons?

Complete the sentence below. (1m)

He classified the buttons according to _____

(b) Who (Su Lin or Siti) has classified the buttons according to their colour? (1m)

- (c) Classify the 8 buttons into 3 groups again.
Draw the buttons in the spaces provided.

Your classification **must be different** from the 3 pupils' classification above. (1m)

Your classification of the 8 buttons:

--	--	--

- (d) Explain how you have classified the buttons in (c). (1m)

I classified them according to _____

33 The diagram below shows the life cycle of a plant. Study it and answer the following questions.

The Life Cycle of a Plant

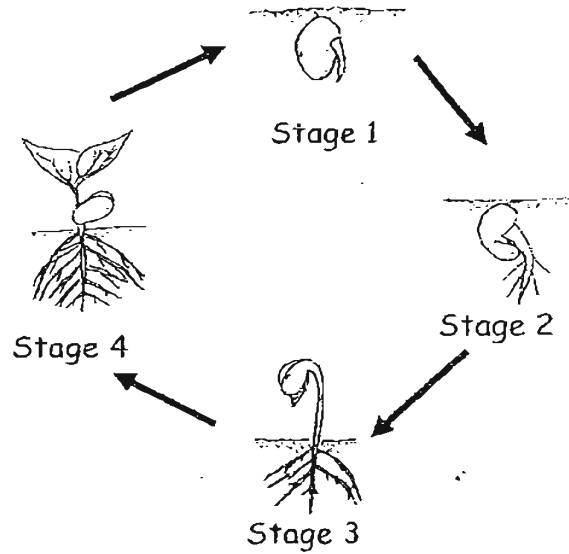

(a) At which stage will the plant be able to make its own food?(1m)

(b) Explain your answer in (a). (1m)

34 Look at the pictures below.

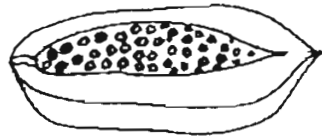

Fruit A

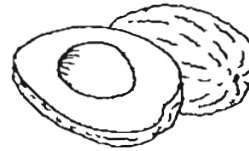

Fruit B

(a) Based only on the pictures, state TWO differences between Fruit A and Fruit B.
(DO NOT compare shape, size and colour) (2m)

(i) _____

(ii) _____

(b) Based only on the pictures, state ONE similarity between Fruit A and Fruit B.
(DO NOT compare shape, size and colour) (1m)

35 The flow chart below shows the characteristics of three parents. Study it and answer the following questions.

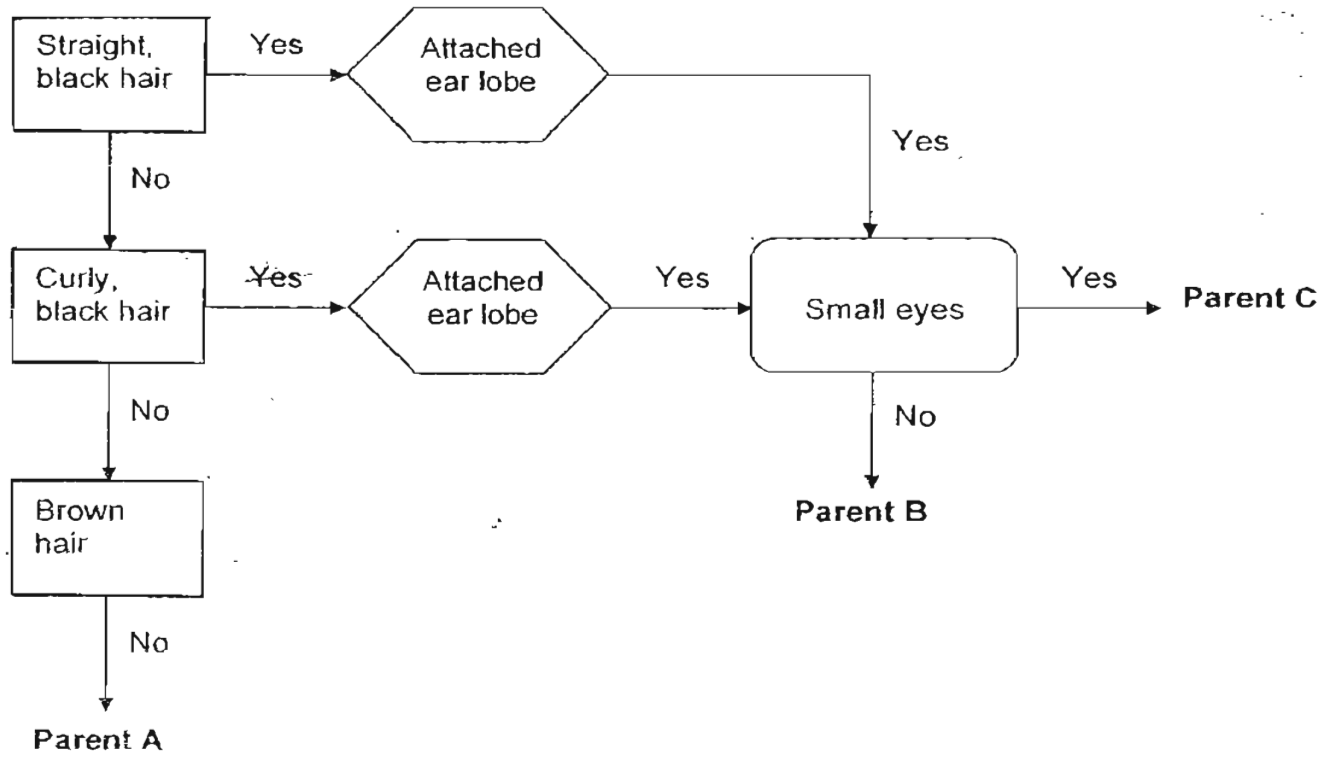

(a) State **TWO** characteristics of Parent B. (2m)

- (i) _____
- (ii) _____

(b) Khairy has straight black hair, attached ear lobe and a pair of small eyes.

Who is most likely to be Khairy's parent? (1m)

Parent _____

36 Study the table below.

Animal	Number of young /eggs produced each time
P	2
Q	80
R	120

(a) Which animal above is likely to take care of its young? (1m)

(b) Is Animal R more likely to give birth to its young or lay eggs? (1m)

(c) Circle the group that Animal R is most likely to belong to. (1m)

Mammals

Birds

Insects

37 Sam conducted an experiment as shown below. He wanted to find out which material is able to carry the most weight.

He used 3 strings, X, Y and Z, made of different materials.

He kept adding weight until the material broke.

The table below shows the results.

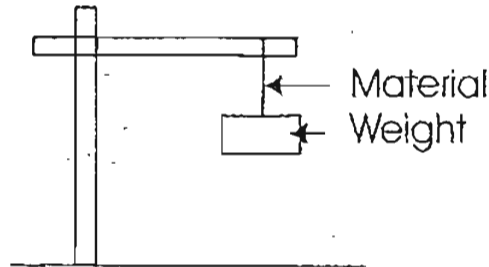

Weight	Material X	Material Y	Material Z
10 g	X	√	√
30 g	X	√	√
50 g	X	X	√

X – Material broke
√ - Material did not break

(a) Which material(s) would be able to hold a weight of 25g? (1m)

(b) Which material is the strongest? (1m)

Material _____

(c) Explain your answer in (b). (1m)

38 Susan observed some footprints left on the beach in the sand.

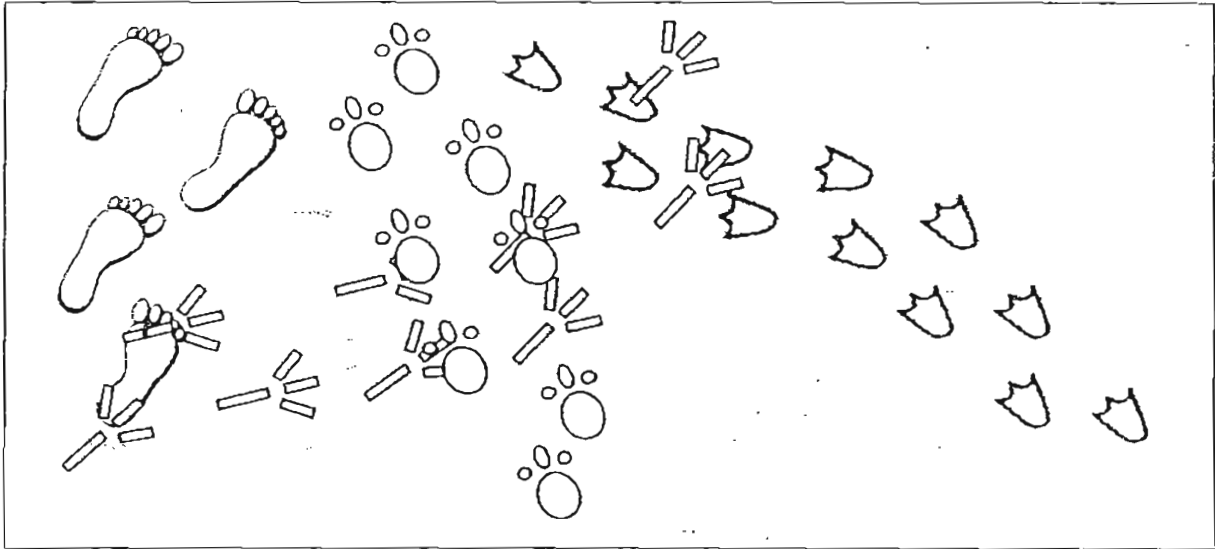

(a) How many different living things made these footprints? (1m)

(b) Draw **ONE** of the footprints that shows the **LAST** living thing that walked across the beach in the space below. (1m)

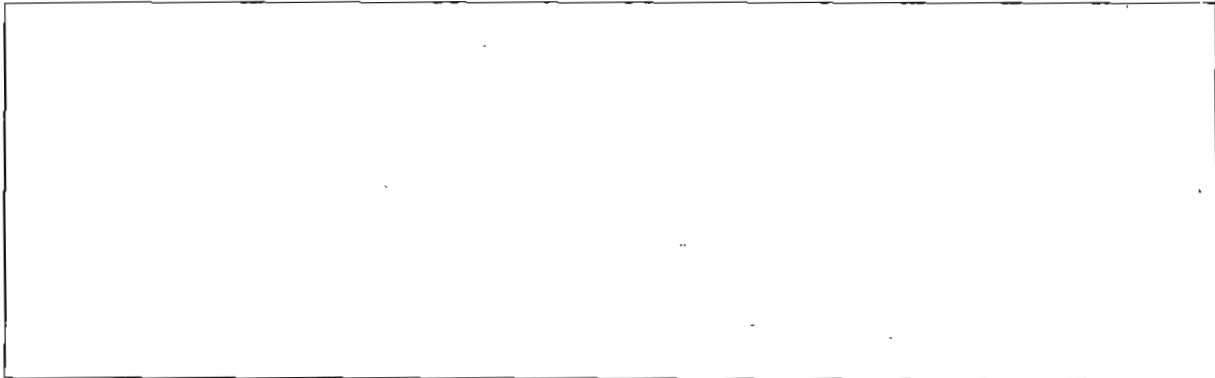





- 39 The classification below shows the functions of 4 different systems in our body.
 (a) Fill in the boxes with the helping words below. (2m)



Body Systems

(i)	(ii)	(iii)	(iv)
Function: Pumps oxygen and blood to all parts of the body.	Function: Helps the different parts of the body to move.	Function: Takes in oxygen for the body.	Function: Supports the body and gives it shape.

- (b) Tick the organ below that is a part of the respiratory system. (1m)

			
Heart	Nose	Skull	Mouth

40 The diagram below shows some of the organs in our digestive system.

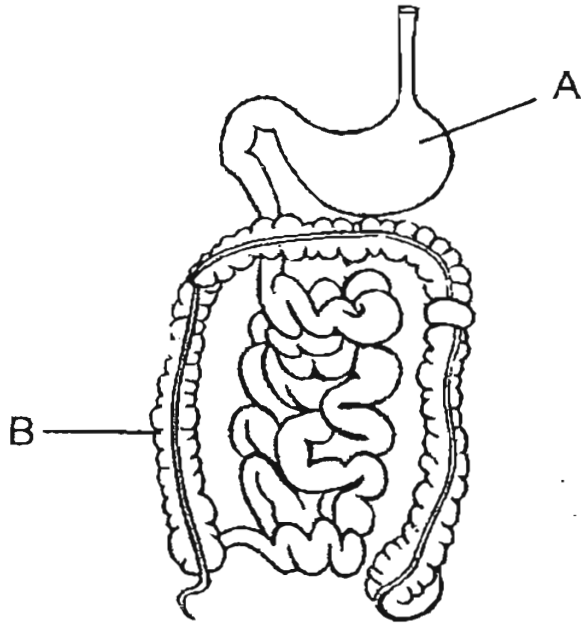

(a) Name organ A as shown above. (1m)

A: _____

(b) What is the function of Organ B? (1m)

41 Plants carry out a process to make food when there is light.

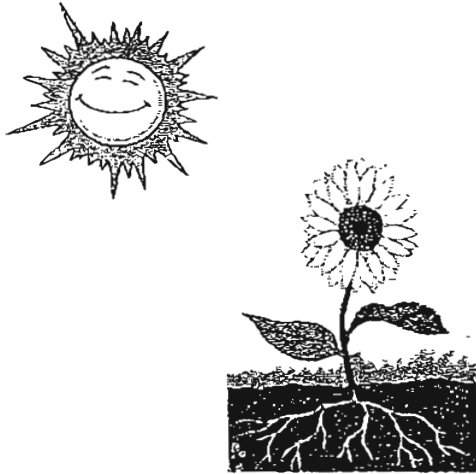

(a) What is this process called? (1m)

(b) Besides sunlight, name **ONE** other thing plants need in order to carry out the process stated in (a). (1m)

(c) Name the **part** of the plant that helps to take in / provide the thing stated in (b). (1m)

42 Jason carried out an experiment. He grew 2 pots of seedlings, A and B on the same day and took care of them for a week. He then measured the height of the seedlings on the 7th day.

The chart below records what he gave to each pot during the week. Study the chart carefully.

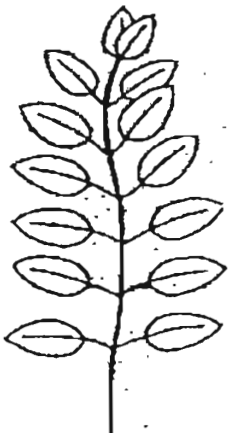
Seedlings	A	B			
Height of the seedlings in cm 30 25 20 15 10 5					
			Amount of fertiliser given everyday	0ml	2ml
			Amount of water given everyday	40ml	40ml
			Location it was placed	Garden	Garden

(a) Based on the chart, what was the aim of his experiment?
Complete the sentence below. (1m)

He wants to find out if _____

(b) Name **ONE** thing that Jason has to keep the same for his experiment to be fair.
(**DO NOT** mention those already stated above.) (1m)

- 43 Four iron nails, **W**, **X**, **Y** and **Z** were attracted to a bar magnet as shown below. They were then lowered into a container of iron fillings.

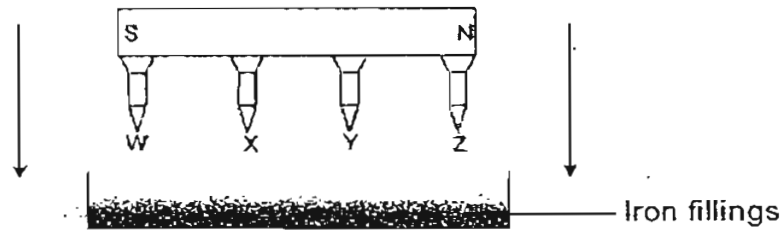

- (a) Which **TWO** iron nails would be able to attract the most iron fillings? (1m)

- (b) Explain your answer in (a) **CLEARLY**. (1m)

- 44 Ahmad carried out an experiment to find out the strength of 3 bar magnets, **A**, **B** and **C** by finding out the number of paper clips each magnet can attract.

Below are his results.

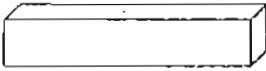
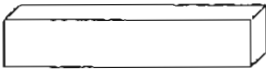
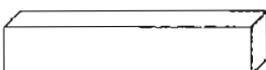
Magnets		Number of paper clips attracted
A		5
B		8
C		6

- (a) Which is the strongest magnet? (1m)

- (b) What can Ahmad conclude about the strength of magnets of the same size and shape from his experiment? (1m)

45 Jack made two electromagnets with Object X and Object Y as shown in the diagrams below.

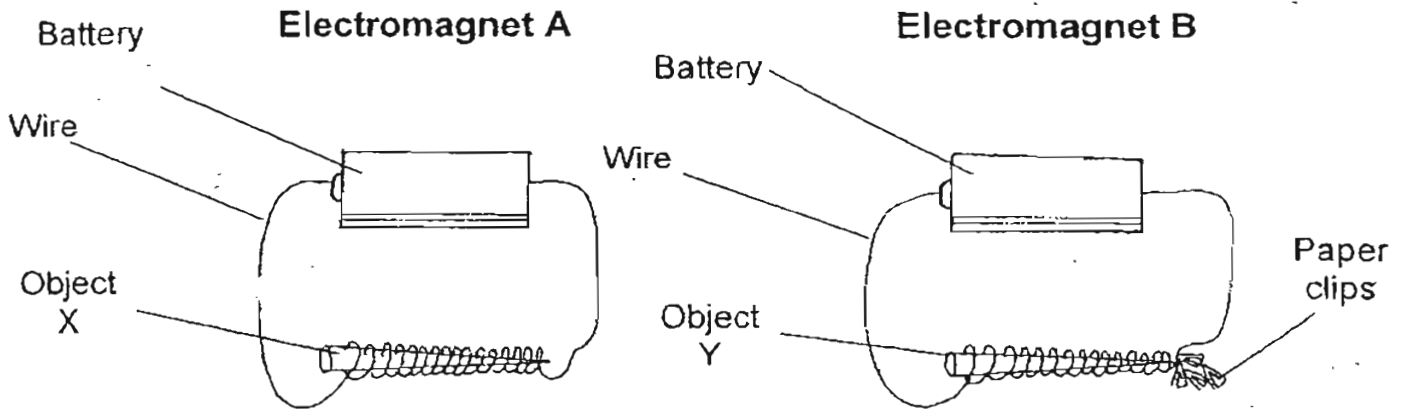

(a) Electromagnet A **did not** attract any paper clips. State **ONE** reason for that. (1m)

(b) State **ONE** way to make electromagnet B attract more nails. (1m)

- 46 Kelly hung a bar magnet above a paper clip which was tied to a weight by a string. The paper clip was then suspended in the air as shown below.

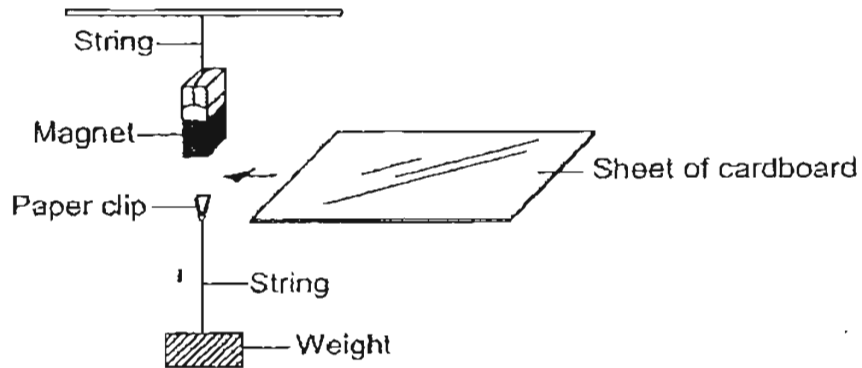

- (a) Kelly placed a sheet of cardboard between the magnet and the paper clip. What would she observe? (1/2m)
-

- (b) Kelly then placed an **iron sheet** between the magnet and the paper clip. What would she observe? (1/2m)
-

- (d) Which characteristic of magnets is Kelly trying to show? (1m)
-
-

Setters: Mdm Taufik
Ms Tan YH

End of Booklet B

Henry Park Primary School
Primary 3 Science SA2 Exams (2007)

Answer Keys

SECTION A : (60 MARKS)

Qn no.	Ans
1	1
2	4
3	1
4	2
5	3
6	1
7	2
8	2
9	2
10	3

Qn no.	Ans
11	2
12	3
13	1
14	2
15	2
16	4
17	3
18	3
19	3
20	1

Qn no.	Ans
21	4
22	3
23	4
24	3
25	3
26	4
27	2
28	4
29	1
30	1

SECTION B (40 MARKS)

31a. A

31b. (i) 11 kg

(ii) 2 kg

32a. shapes

32b. Siti has classified the buttons according to colour.

33a. Stage 4

33b. That is the leaf has developed completely.

33c.

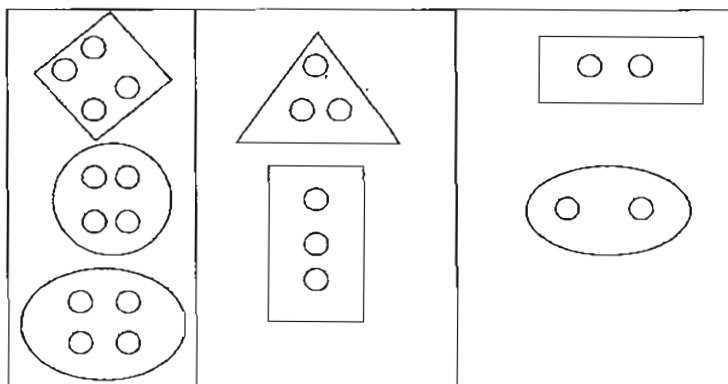

33d. The number of holes

- 34a. (i) Fruit A has many seeds while fruit B has one seed.
(ii) Fruit B has lines but fruit A does not.
34b. They both have seeds.

- 35a. (i) Parent B has attached ear lobe.
(ii) Parent B has straight, black hair.
35b. C

- 36a. Animal P
36b. Animal R is likely to lay eggs.
36c. insect

- 37a. Material Y and Z
37b. Material Z
37c. It can hold up to 50 g.

- 38a. 4 different living things.
38b.

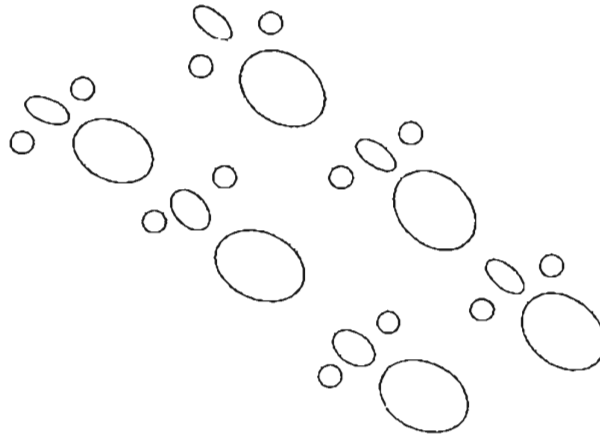

- 39a. (i) Circulatory
(ii) Muscular
(iii) Respiratory
(iv) Skeletal
39b. nose

- 40a. Stomach
40b. Organ B helps to remove excess water from the undigested food.

- 41a. Photosynthesis
41b. Water
41c. Roots

- 42a. Fertilizers will affect the height of plants. / the amount of soil / type of soil / type of plant.
- 42b. The size of plot
- 43a. W and Z
- 43b. Magnets are strongest at its poles.
- 44a. Magnet B
- 44b. They may not have the same magnetic power.
- 45a. Electromagnet A did not attract any paper clips because the battery did not have enough power.
- 45b. Increase the number of battery.
- 46a. The paper clip still suspend in the air.
- 46b. The paper clip will drop.
- 46c. Magnetism passes through non magnetic materials but does not pass through magnetic materials.