



南洋小學  
NANYANG PRIMARY SCHOOL

PRIMARY THREE SCIENCE  
SEMESTRAL ASSESSMENT 2

2011

**BOOKLET A**

Date : 2<sup>nd</sup> November 2011

Duration : 1 h 45 min

Name : \_\_\_\_\_ (     )

Class: Primary 3 (     )

Parent's signature: .....

DO NOT OPEN THIS BOOKLET UNTIL YOU ARE TOLD TO DO SO.  
FOLLOW ALL INSTRUCTIONS CAREFULLY.

Booklet A consists of 21 printed pages including this cover page.

Section A (30 x 2 marks = 60 marks)

For each question from 1 to 30, four options are given. One of them is the correct answer. Make your choice (1, 2, 3 or 4). Shade the correct oval (1, 2, 3 or 4) on the Optical Answer Sheet provided.

1. Which of the following are examples of non-flowering plants?

- (1) pine and orchid
- (2) papaya and lotus
- (3) grass and coconut
- (4) bird's nest fern and moss

2. Study the classification chart below.

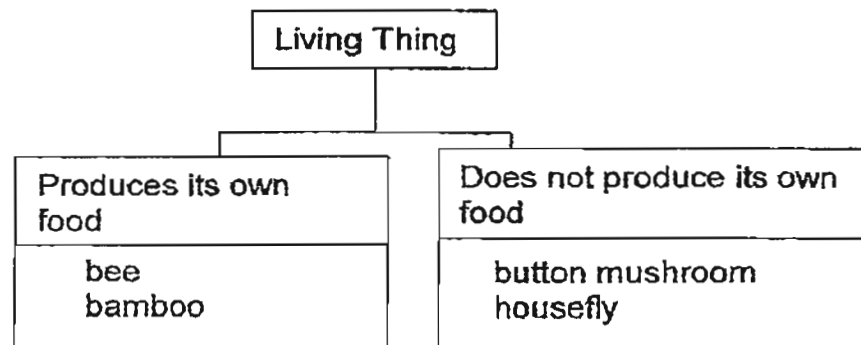

Which organism has classified wrongly?

- (1) bee
- (2) bamboo
- (3) housefly
- (4) button mushroom

3. The table below states the characteristics of four animals J, K, L and M. A tick (✓) means that the animal has that characteristic.

Characteristics	Animal			
	J	K	L	M
Has wings	✓	✓	✓	
Lay eggs	✓		✓	✓
Has a beak	✓			

Which one of the following options, correctly identifies the animals J, K, L and M ?

	J	K	L	M
(1)	duck	mosquito	butterfly	hen
(2)	parrot	cockroach	ant	grasshopper
(3)	sparrow	bat	bee	goldfish
(4)	swordfish	dragonfly	peacock	shark

4. Sammy made the following statements about bacteria :

- A Bacteria can be harmful to us.
- B Bacteria need water, air and food to stay alive.
- C Bacteria can only be seen using a microscope.
- D Bacteria can increase in number through reproduction.

Which of Sammy's statements explain why bacteria are living thing?

- (1) A and B only
- (2) B and D only
- (3) A and C only
- (4) A, B and C

5. The diagram below shows an insect with parts labelled S and T.

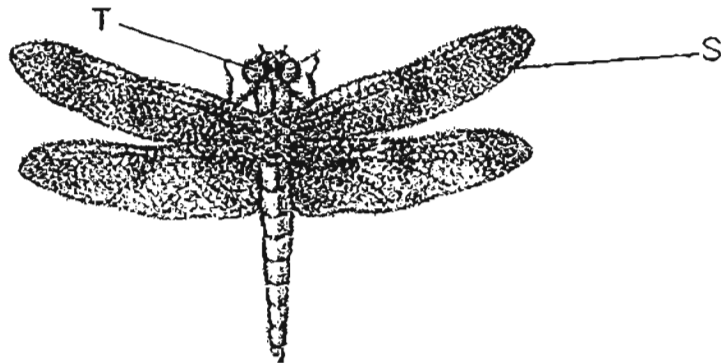

Which one of the following states the function of S and T correctly?

	<b>Function of S</b>	<b>Function of T</b>
(1)	keep body warm	breathe in air
(2)	move away from danger	find shelter
(3)	protect itself	produce young
(4)	feed on plant	find shelter

6. The diagram below shows a pond and its surroundings. V, W and X are three locations where plants are found growing.

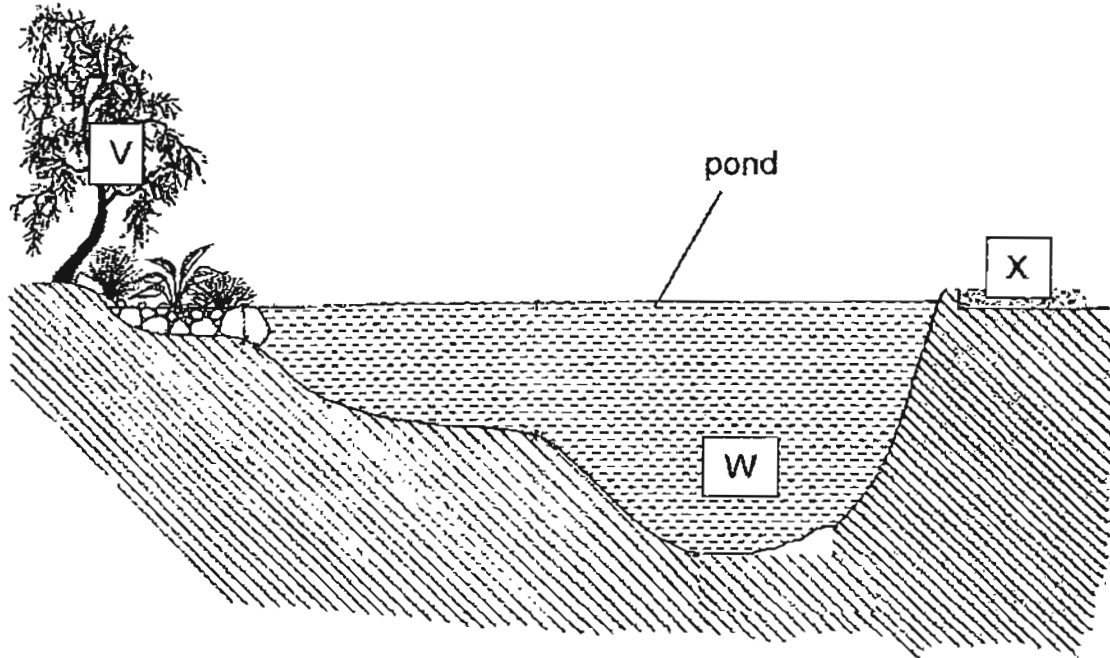

Which one of the following options correctly identifies the plants that can be found growing at V, W and X?

	Plant found growing at		
	V	W	X
(1)	mango	water hyacinth	staghorn's fern
(2)	hibiscus	water lily	rose
(3)	bird's nest fern	hydrilla	hibiscus
(4)	morning glory	onion	lotus

7. The diagram below shows a fern with black powdery substance on the underside of the leaves.

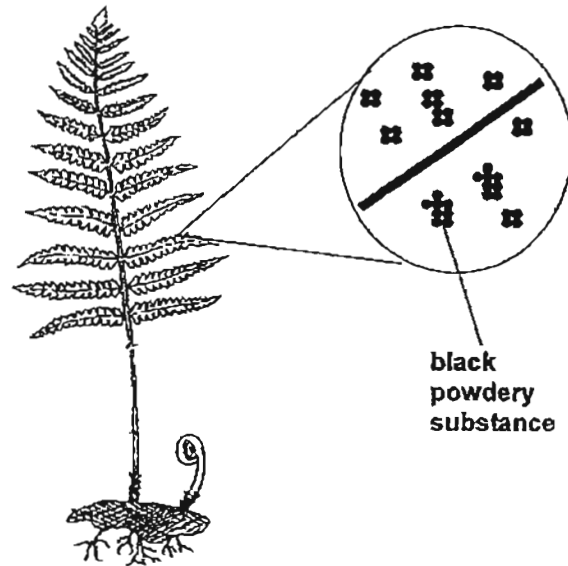

What is the function of the black powdery substance?

- (1) It stores water.
  - (2) It collects light to make food.
  - (3) It allows the fern to reproduce.
  - (4) It prevents animals from eating the fern.
8. Which one of the following consists only of animals with the same body covering?
- (1) bat, elephant, seal
  - (2) penguin, whale, shark
  - (3) guppy, sparrow, ostrich
  - (4) zebra, rhinoceros, flamingo

9. The table below shows the characteristics of E, F, G and H. A tick (✓) means that the characteristic is present.

Characteristics	E	F	G	H
makes its own food		✓		
moves about freely			✓	
grows and increases in size		✓	✓	✓
produces spores				✓

Which one is most likely to be a mammal?

- (1) E                                  (2) F  
(3) G                                  (4) H
10. Judy wants to make a lantern as shown in the diagram below.

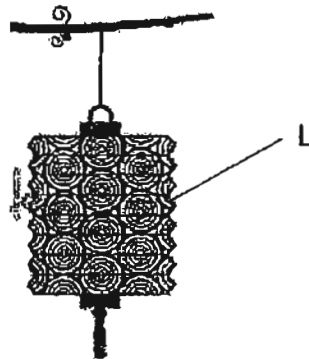

Which of the following properties should she consider when choosing a material to make part L?

- A     It burns easily.  
B     It is light in weight.  
C     It allows some light to pass through.
- (1)    B only  
(2)    B and C only  
(3)    A and C only  
(4)    A, B and C

11. Which one of the following materials was once alive?

- (1) rock
- (2) glass
- (3) plastic
- (4) cardboard

12. The diagram below shows a diver under the sea.

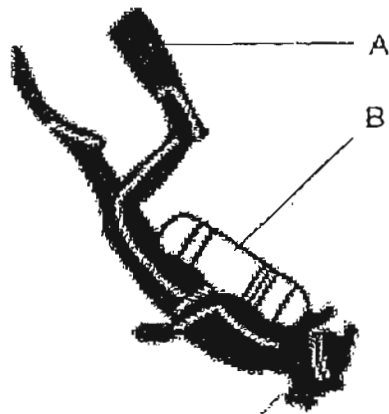

What property should **both** materials A and B have?

- (1) They must be flexible.
- (2) They must float on water.
- (3) They must be waterproof.
- (4) They must allow light to pass through.

13. Peter dropped a heavy brick from a height of 3 metres onto the following objects.

- A plasticine
- B cardboard
- C porcelain cup
- D drinking glass

Which of the objects, A, B, C or D would break into pieces when they are hit by the brick?

- (1) A and B only
- (2) A and C only
- (3) B and C only
- (4) C and D only





16. The diagram below shows a container filled with a mixture of steel filings and sand.

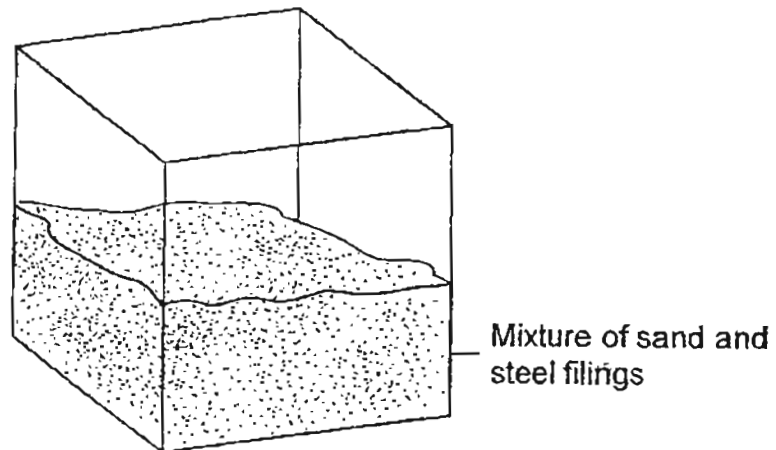

Which one of the following statements best explains why a magnet could be used to remove only the steel filings out of the container?

- (1) Steel filings is lighter than sand.
- (2) Sand will be repelled by the magnet.
- (3) Magnetism can pass through the glass container.
- (4) Sand is a non-magnetic material whereas steel is a magnetic material.

17. The diagram below shows five bar magnets with their ends marked A to J arranged as shown below.

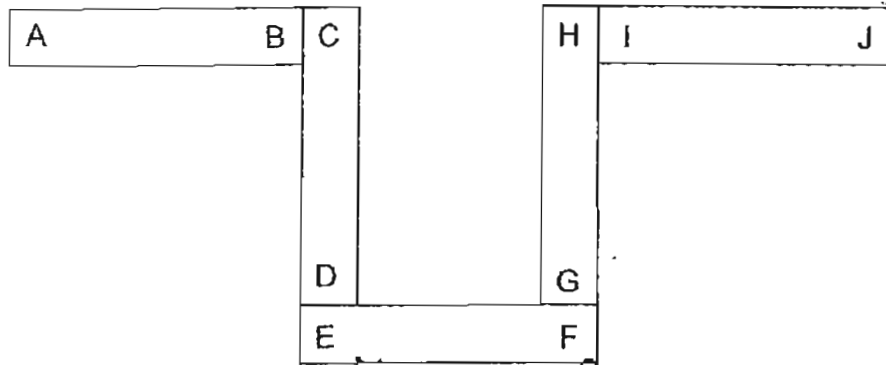

Which of the following shows a possible arrangement of some of the magnets?

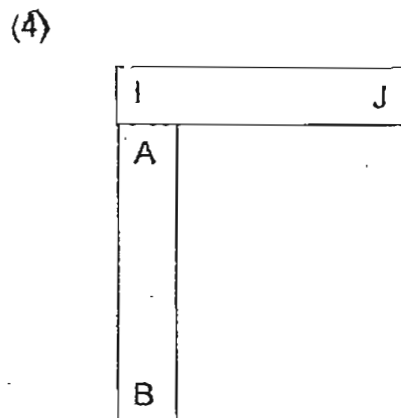
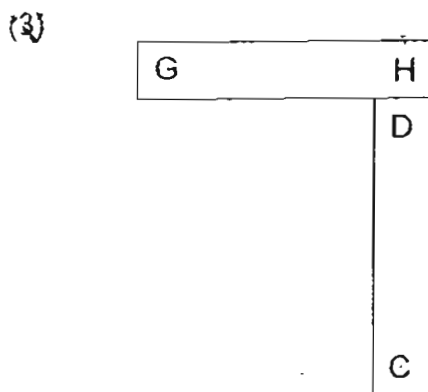
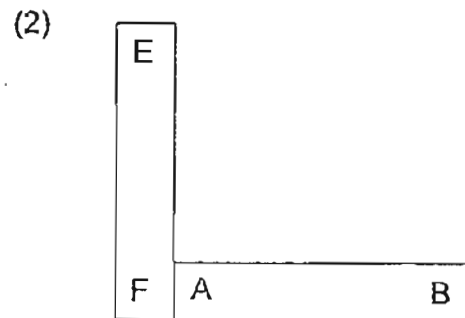
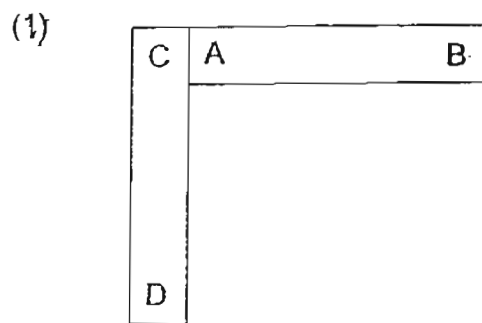

18. Which of the following objects allow magnetism to pass through?

- A paper
- B iron sheet
- C wooden ruler
- D aluminium foil

- (1) A, B and C only
- (2) A, B and D only
- (3) A, C and D only
- (4) B, C and D only

19. Xiao Wei wants to magnetise a steel rod using a magnet as shown below.

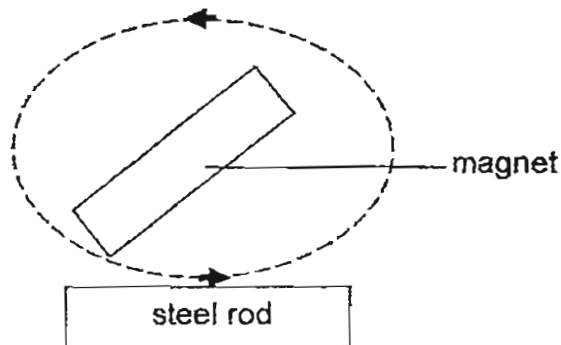

Which of the the following will increase the strength of the magnetised rod?

- (1) Decreasing the length of the magnet.
- (2) Increasing the thickness of the steel rod.
- (3) Increasing the number of times the magnet is used to stroke the steel rod.
- (4) Changing the directions in which the magnet is used to stroke the steel rod.

20. Which of the following actions could cause a magnet to lose its magnetism?
- (1) Rub the magnet with water.
  - (2) Leave the magnet next to an open flame.
  - (3) Stroke the magnet gently several times with a piece of wood.
  - (4) Place the magnet next to another magnet with opposite poles facing each other.
21. Compare the leaves shown in the diagram below.

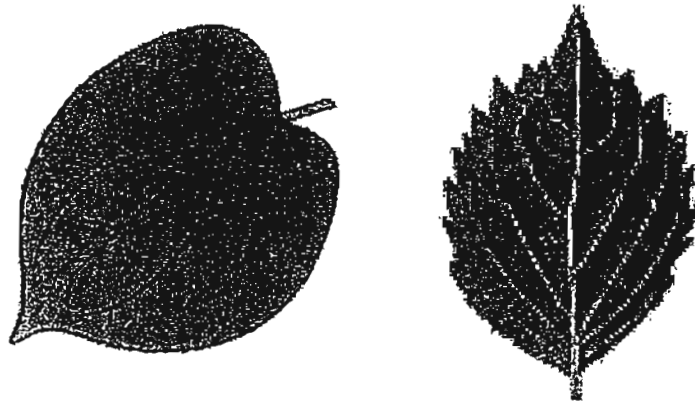

Which of the following conclusions can be made based only on the diagram alone?

- A They have the same shape.
  - B They have the same vein patterns
  - C They are both leaves of orchid plants.
- 
- (1) A and B only
  - (2) A and C only
  - (3) B and C only
  - (4) A, B and C only

22. The diagram below shows four leaves, A, B, C and D.

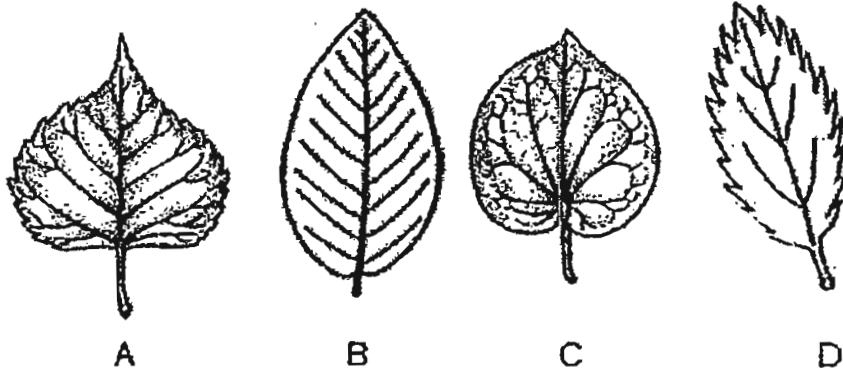

Four pupils, Faris, George, Hui Xin and Ivan, classified the leaves above as shown below.

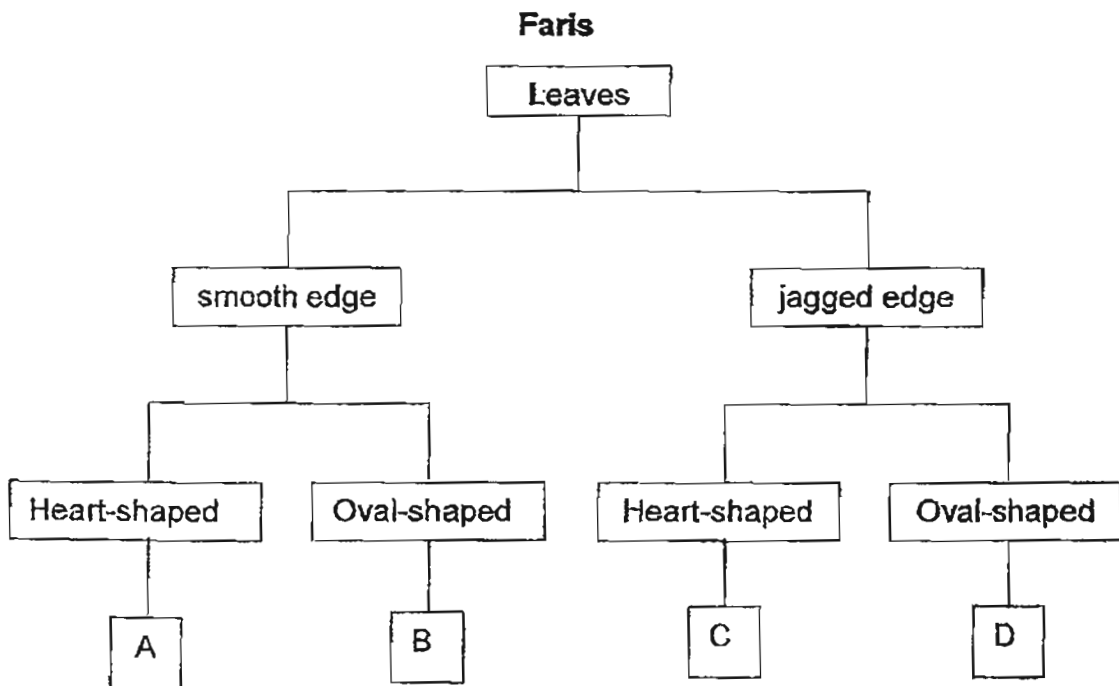

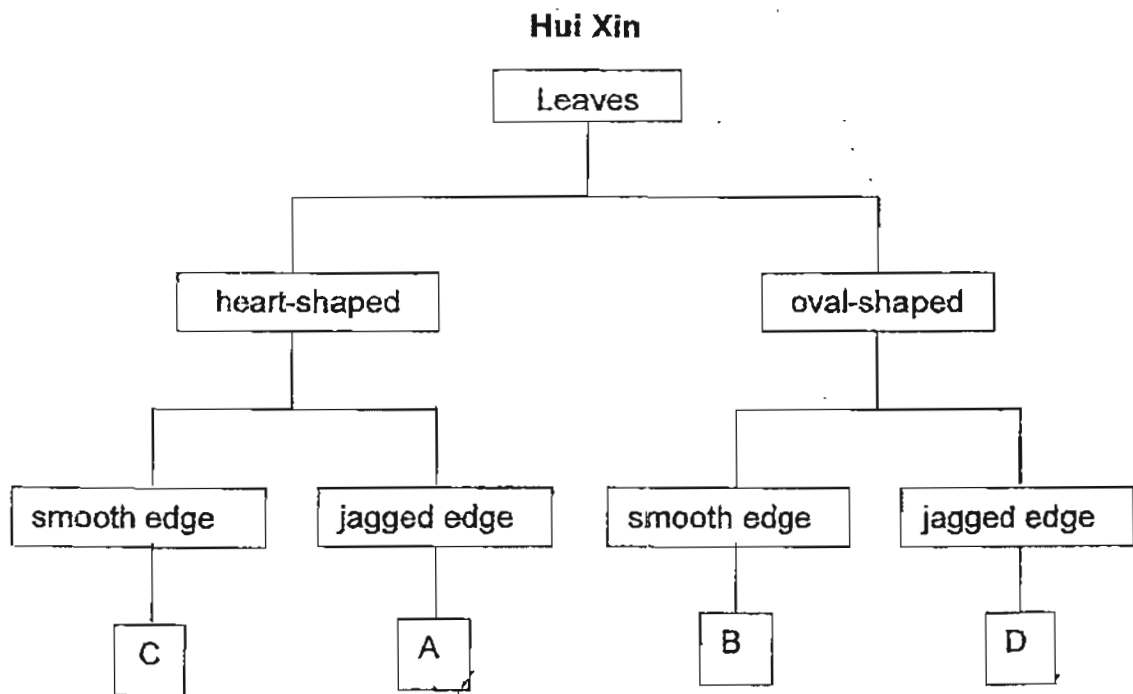
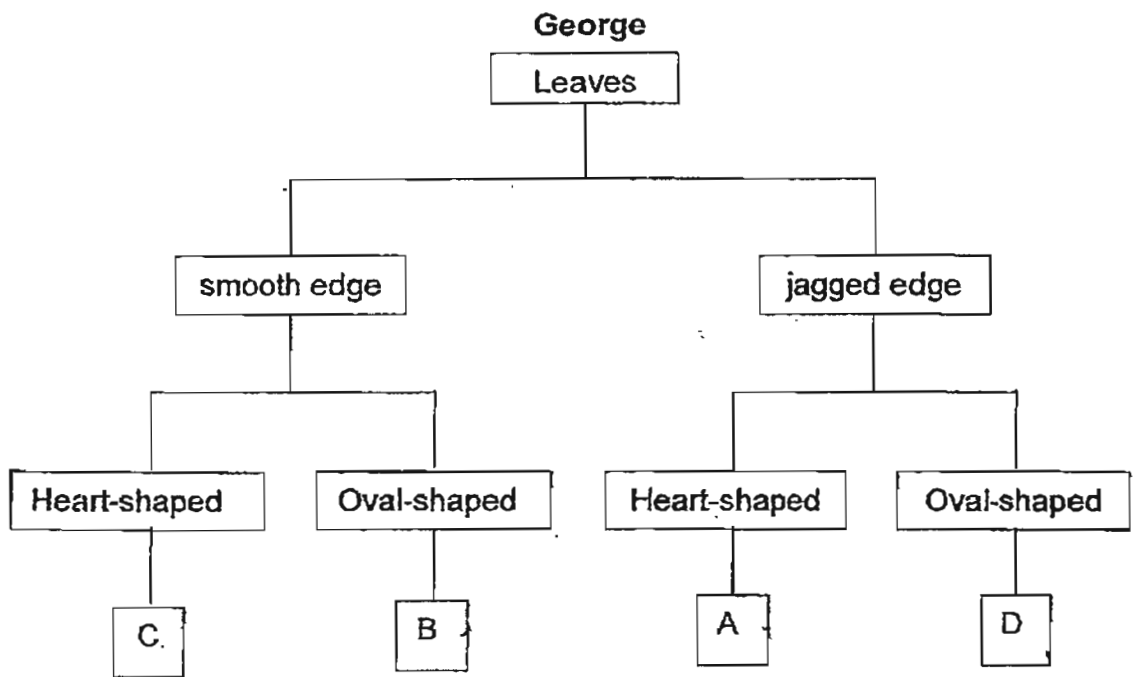

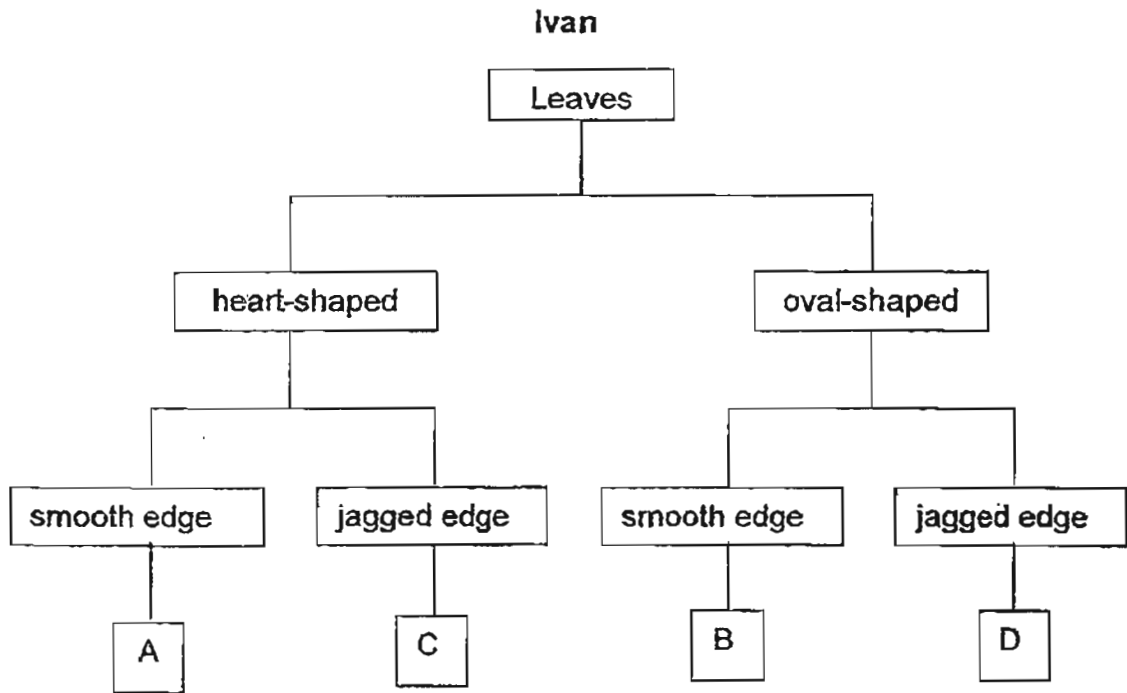

Which of the pupils have classified the leaves correctly?

- (1) Faris and Ivan
- (2) George and Ivan
- (3) Faris and George
- (4) George and Hui Xin



23. The diagram below is of a water hyacinth.



Which of the following statements are true about the functions of the roots of a water hyacinth?

- A To absorb water for the plant.
  - B To help the plant stay upright.
  - C To absorb mineral salts for the plant.
  - D To hold the plant firmly to the ground.
- (1) A and B only                      (2) A and C only  
(3) A, B and C only                (4) A, B and D only

24. Which of the following human body systems show an increase in activity when a person is running?

- A muscular system
  - B respiratory system
  - C circulatory system
- (1) A and B only                      (2) A and C only  
(3) B and C only                      (4) A, B and C only

25. Study the diagram below. Only the food carrying tube was removed from the plant.

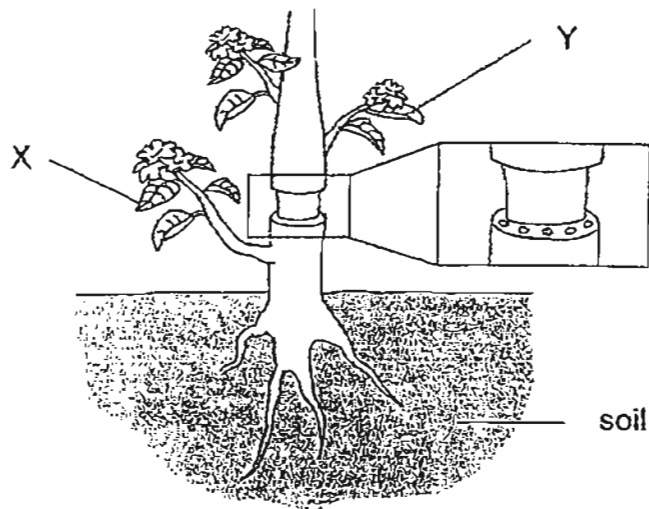

It was observed that the plant was still alive after a few days. Which of the following reasons best explains why the plant was able to remain alive?

- (1) The root was able to absorb food from the soil.
- (2) The root was still able to absorb mineral salts from the soil.
- (3) The root was able to absorb water for the leaf labelled Y to make food.
- (4) The leaf labelled X was able to make food and transport it to the root.

26. Study the diagram below.

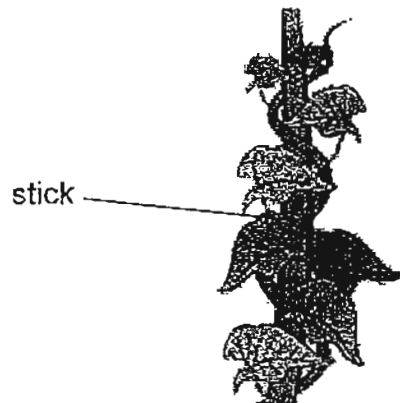

Plant A

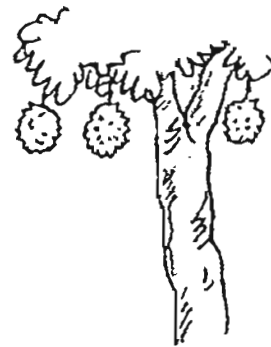

Plant B



Plant C

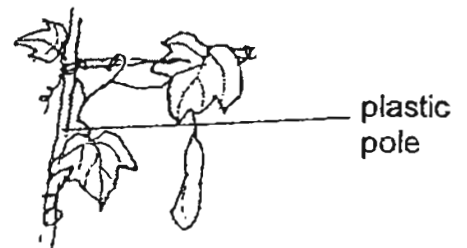

Plant D

The plants were classified as shown in the table below. X and Y represents the headings for the table.

X	Y
Plant A	Plant B
Plant D	Plant C

Which of the following best represents X and Y?

	X	Y
(1)	flowering plants	non-flowering plants
(2)	plants with weak stem	plants with woody stem
(3)	land plants	water plants
(4)	plants that do not bear fruits	plants that bear fruits

27. Which of the following statements about our body parts are true?

- A Our heart is the biggest organ in the body.
- B Blood vessels are part of the circulatory system.
- C Skeletal system consists of the skull and ribs only.
- D The nose and the lungs are part of the respiratory system.

- (1) A and B only
- (2) B and C only
- (3) B and D only
- (4) C and D only

28. The diagram below shows parts of the digestive system of a human body.

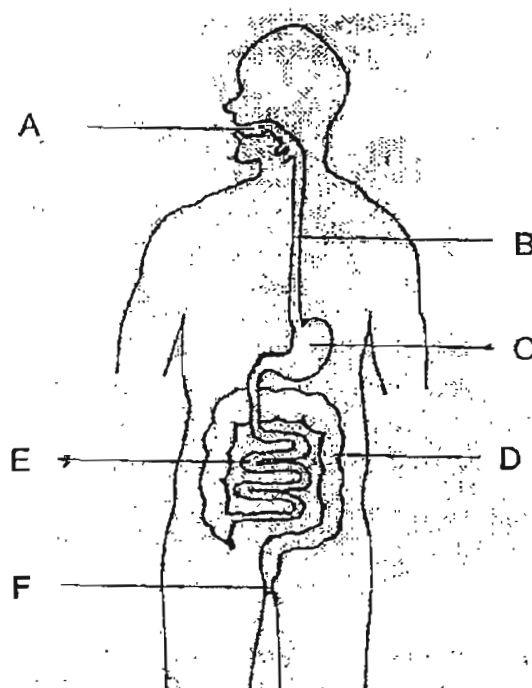

In which parts do digestion take place?

- (1) A and C only
- (2) A and D only
- (3) A, B and D only
- (4) A, C and E only

29. The diagram below is a simplified way of showing how the blood travels in the body.

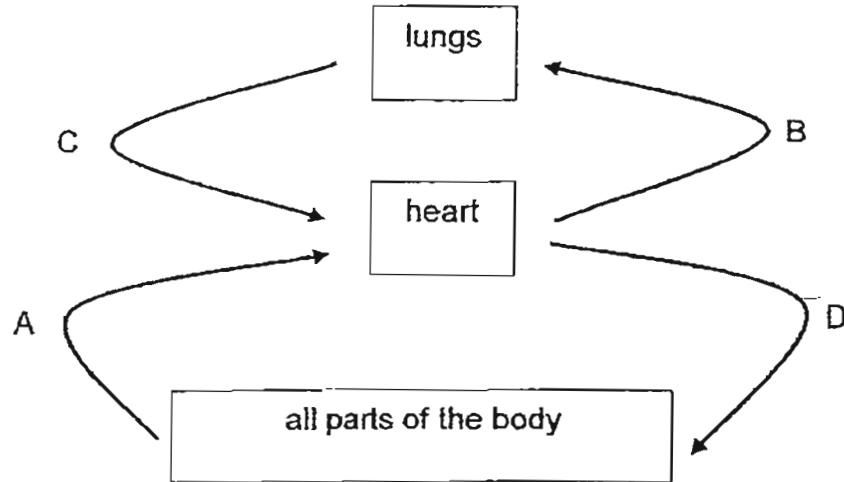

Which arrows should represent the movement of blood rich in carbon dioxide?

- |                  |                  |
|------------------|------------------|
| (1) A and B only | (2) A and C only |
| (3) B and D only | (4) C and D only |
30. Which of the following functions of the rib cage are true?
- A It gives our chest its shape
  - B It helps us to move our arms.
  - C It protects our heart and lungs.
  - D It protects our stomach and small intestines.
- |                     |                     |
|---------------------|---------------------|
| (1) A and B only    | (2) A and C only    |
| (3) A, B and C only | (4) B, C and D only |



南洋小學

NANYANG PRIMARY SCHOOL

PRIMARY THREE SCIENCE

SEMESTRAL ASSESSMENT 2

2011

**BOOKLET B**

Date : 2<sup>nd</sup> November 2011

Duration : 1 h 45 min

Name \_\_\_\_\_ ( )

Class: Primary 3 ( )

Marks Scored:

Booklet A:		60
Booklet B :		40
Total :		100

Parent's signature:

-----

DO NOT OPEN THIS BOOKLET UNTIL YOU ARE TOLD TO DO SO.  
FOLLOW ALL INSTRUCTIONS CAREFULLY.

Booklet B consists of 14 printed pages including this cover page.

Section B (40 marks)

Write your answers to questions 31 to 46 in the spaces provided.  
Marks will be deducted for misspelt key words.

31. The diagram shows a plant with parts labelled B and C.

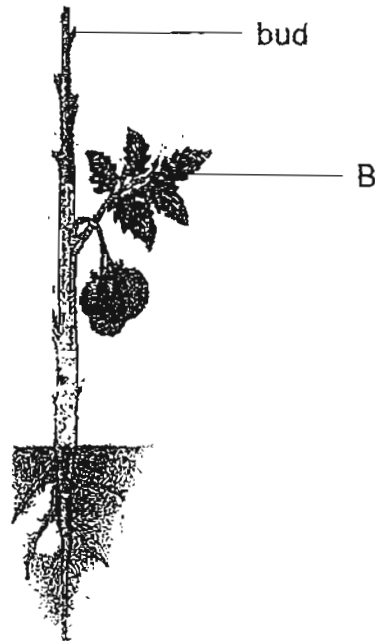

(a) It is observed that when part B is removed, the plant died. [1]  
Explain why this happened.

---

---

(b) Name the part of the plant that keeps it upright to receive light. [1]

---

32. Sam saw a caterpillar feeding on the leaf of plant K in his garden.

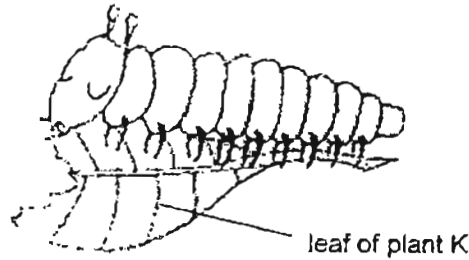

He removed some leaves of plant K, weighed them and placed them in a box on Day 1 of his investigation. Then he placed the caterpillar in the same box. On Day 3, he removed all the leaves from the box and weighed them.

The bar graph below shows the weight of the leaves in the box at the start of the experiment. The weight of the leaves for Day 3 has not been drawn yet.

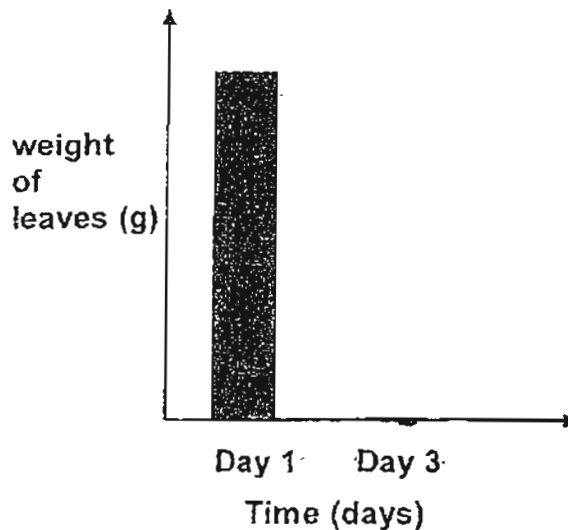

- (a) i) On the bar graph above, draw the bar representing the weight of the leaves on Day 3. [1]
- (a) ii) Explain your answer in part (i). [1]

---

---

- (b) State one difference in the mass of the caterpillar on Day 1 and Day 3 that Sam would expect to observe. Explain why this change happened. [2]

---

---



33. Study the flow chart below.

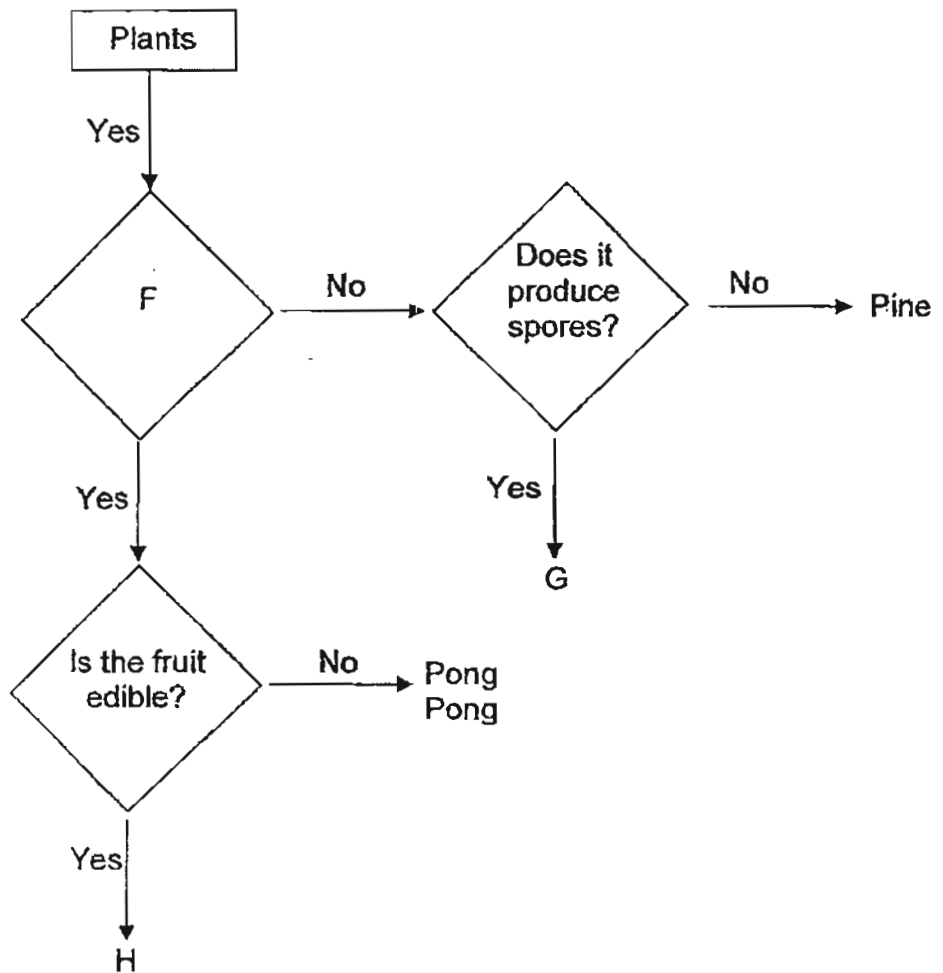

(a) i) Give a specific example of plant G. [1]

---

(a) ii) Give a specific example of plant H. [1]

---

(b) Write a suitable question to represent "F". [1]

---

(c) Explain why mushrooms could not be classified in the flow chart. [1]

---

---

34. Study the diagram of the cow shown below.

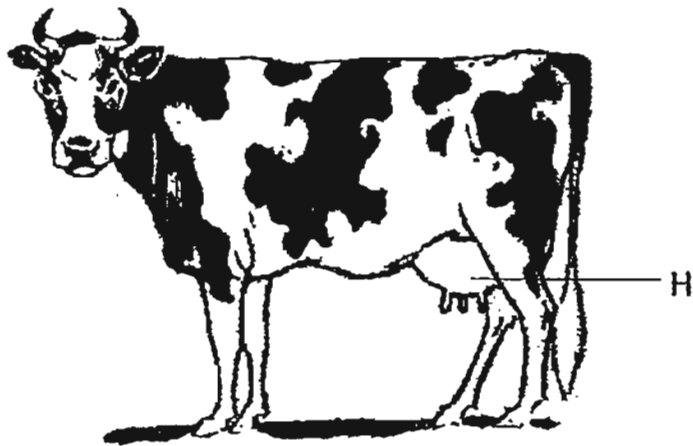

The part labelled H is an important part of mammals.

- (a) Explain why H is important for the cow's offspring. [1]

---

---

- (b) State another part of the cow that classifies it as a mammal. [1]

---

- (c) Julii owns a farm which consists of 2 areas in the farm, A and B. The table below shows the description of the 2 areas. A tick (✓) means that the characteristic is present.

	A	B
Availability of water	✓	
Availability of grass	✓	
Availability of shade		✓

In which area, A or B, would most of the cows be found? Explain your choice. [1]

---

---

35. The diagram below shows a toy with parts labelled P and Q.

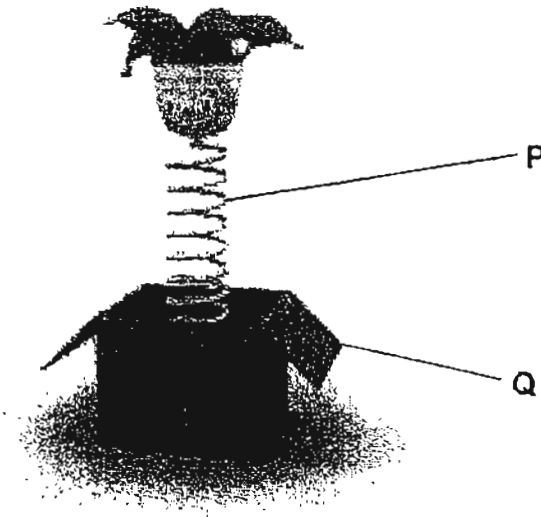

The toy is first pushed into the box before the box is closed. When the box is opened, the toy springs out.

- (a) What property must the material used to make part P have so that the toy could spring out when the box is opened? [1]

---

- (b) What property must part Q have so that the toy could not be seen when it is still in the box? [1]

---

36. Study the three objects below. State the materials used to make each object and identify the important property that best enables the object to serve its function.

(a)

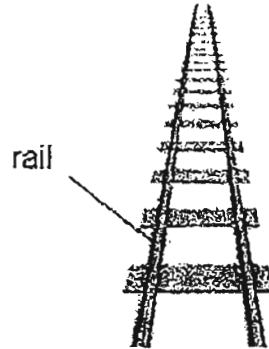

Name of material for making the rail of train track : \_\_\_\_\_

Property of material: \_\_\_\_\_ [1]

(b)

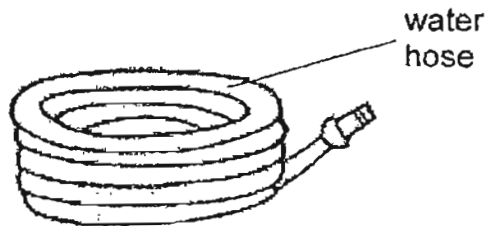

Name of material for making the water hose : \_\_\_\_\_

Property of material : \_\_\_\_\_ [1]

(c)

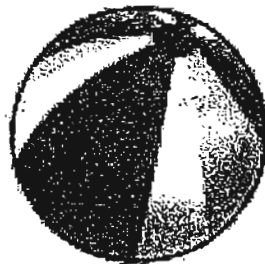

Name of material for making the beach ball : \_\_\_\_\_

Property of material : \_\_\_\_\_ [1]

37. Sally placed 2 objects, A and B, above a container of paper clips. She noticed that paper clips were attracted to both objects.

(a) What was she trying to identify about object A and B when she placed them near the paper clips? [1]

---

She then placed A and B, one at a time, at an equal distance under the plastic sheet, as shown below. She moved each object across the plastic sheet to try and move the car forward.

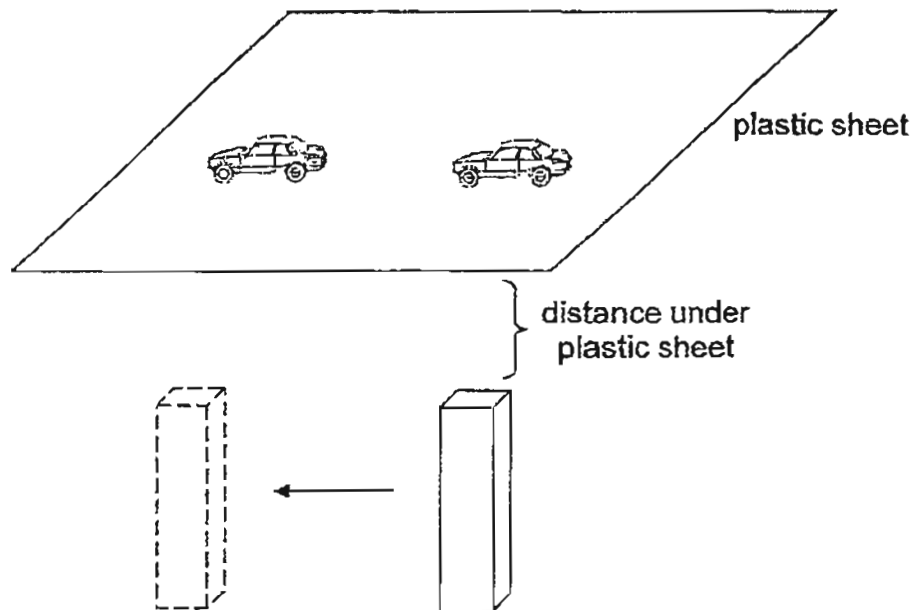

Object A was able to move the toy car whereas B was not able to move the toy car.

(b) Based on the experiment with the toy car, which object would be able to attract more paper clips? Explain your answer. [2]

---

---

---

---

38. Joel sets up the 4 arrangements of electromagnets as shown below.

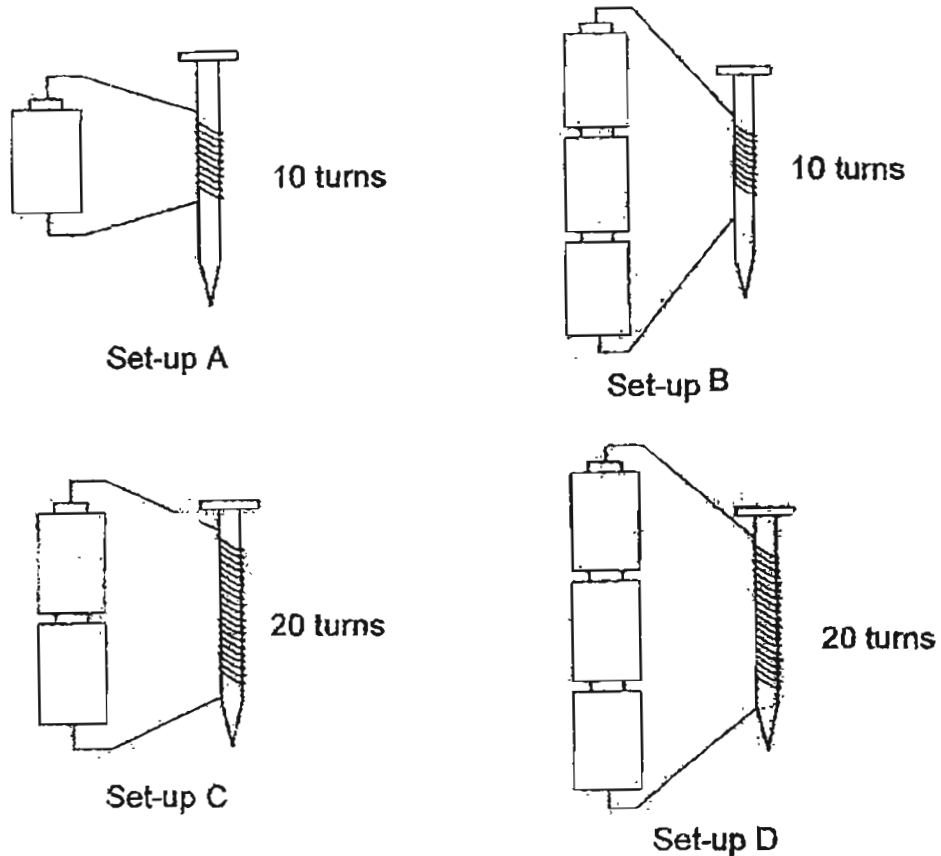

(a) i) Which 2 set-ups should he use if he wants to find out how the number of batteries affect the strength of the electromagnet? [1]

---

(a) ii) Based on your answer in part (i), which set-up will produce a stronger electromagnet? Explain your choice. [1]

---



---

(b) i) Which 2 set-ups should he use if he wants to find out how the number of coils of wire affect the strength of the electromagnet?

---

(b) ii) Based on your answer in part (i), which set-up will produce a stronger electromagnet? Explain your choice. [1]

---



---

39. Joanne had four magnets, A, B, C and D, as shown below.

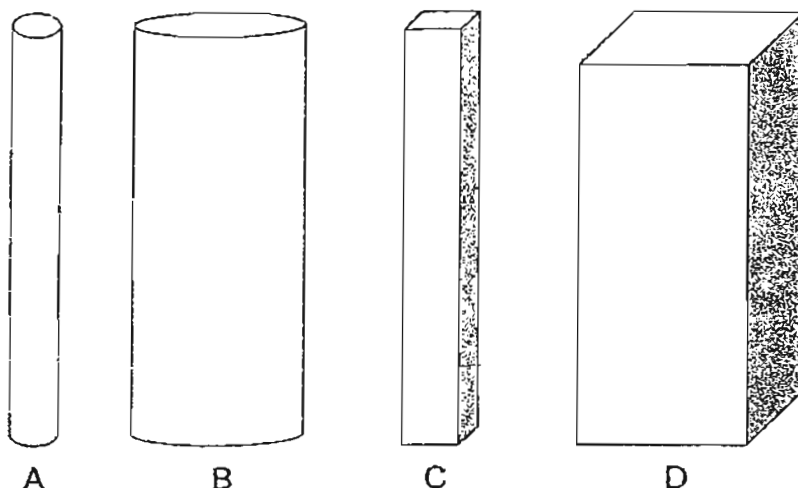

To compare the strength of the magnets, she brought each of the magnets near a pile of pins. The table below shows the number of pins attracted by the magnets from various distances.

Magnets	Distance between magnets and pins (cm)	Number of pins attracted
A	5	12
B	4	12
C	6	10
D	4	13

Based only on the results of her experiment, put a tick (✓) in the correct box for each of the statements. [2]

	True	False	Not possible to tell
Magnet A is stronger than Magnet C			
Magnet D is stronger than Magnet B			
Magnet A is as strong as Magnet B.			
Magnet C is the weakest magnet.			

40. The diagram below shows two plants, A and B, which were left in the sun and given enough water. The leaves of plant A were covered with black paper.

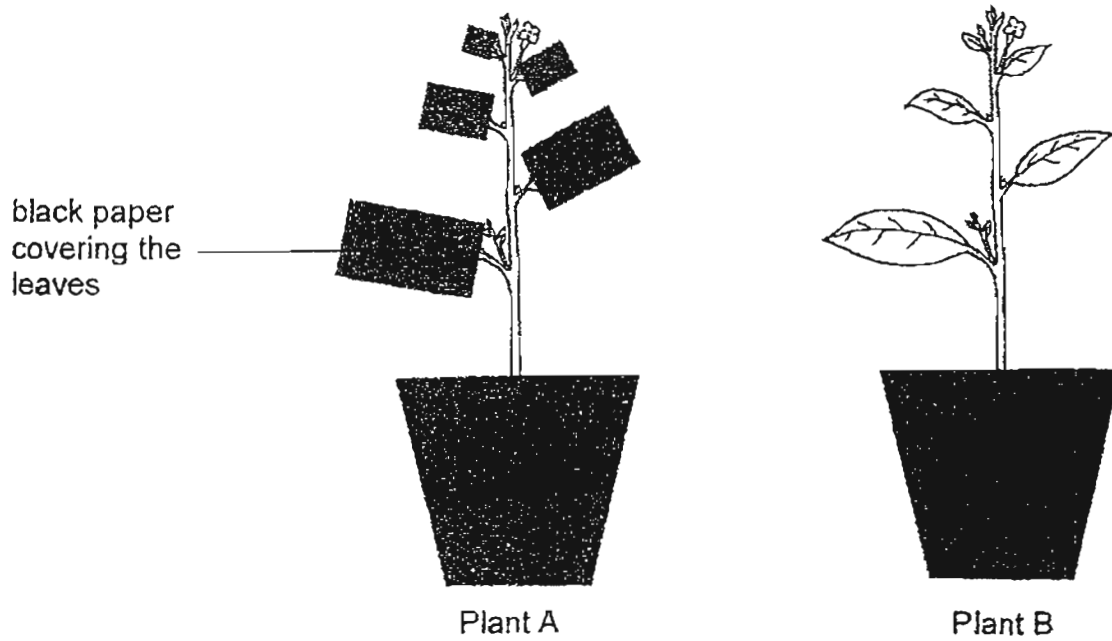

- (a) Predict and explain what will happen to plant A in 2 weeks time. [2]

---

---

The diagram below shows the arrangement of leaves of a plant.

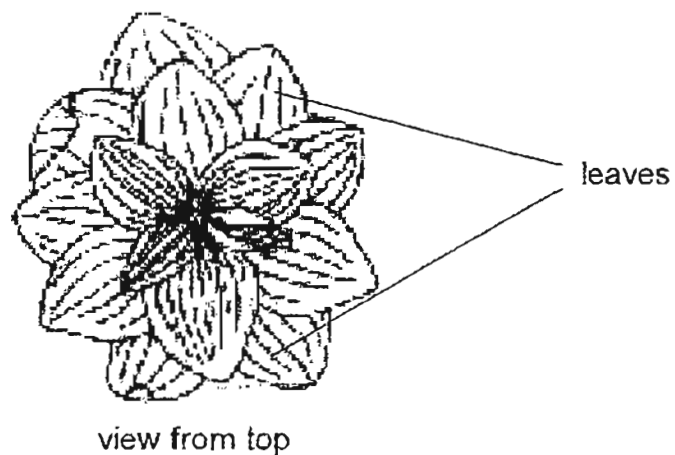

- (b) Explain how this arrangement of leaves benefits the plant. [1]

---

---



41. The diagram below shows two different riverbanks.

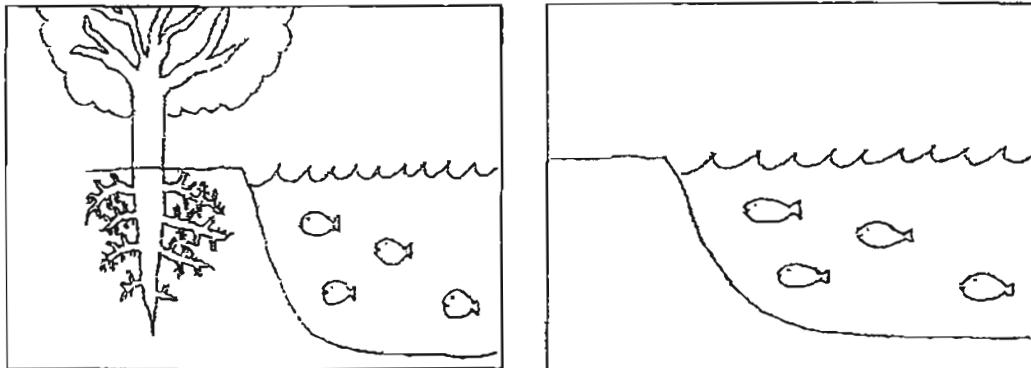

Riverbank A

Riverbank B

John noticed that the water in Riverbank B was more muddy than the water in Riverbank A after a heavy rain. Give a reason for his observation. [2]

---

---

42. (a) State two functions of the large intestine. [2]

i) \_\_\_\_\_

ii) \_\_\_\_\_

- (b) Name the part of the digestive system where digested food is absorbed into the bloodstream. [1]

---

43. The diagram below shows the human respiratory system.

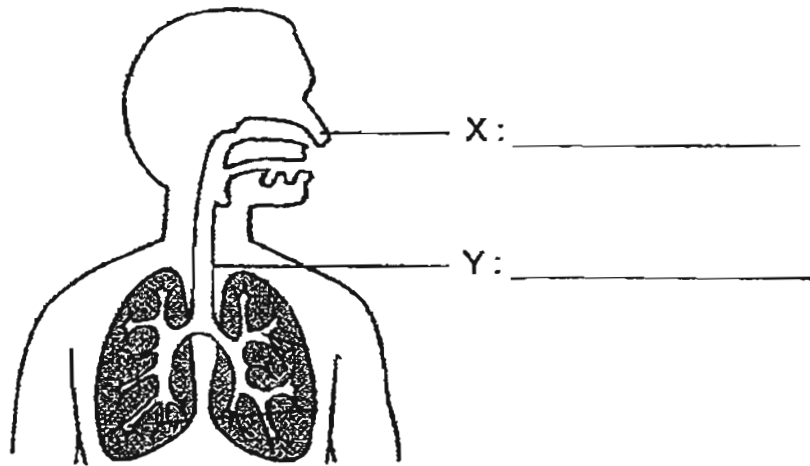

- (a) Identify parts X and Y of the respiratory system. [1]
- (b) Explain why it is dangerous for a human being if part Y is blocked. [1]

---

---

44. The diagram shows the muscles and bones found in a human arm.

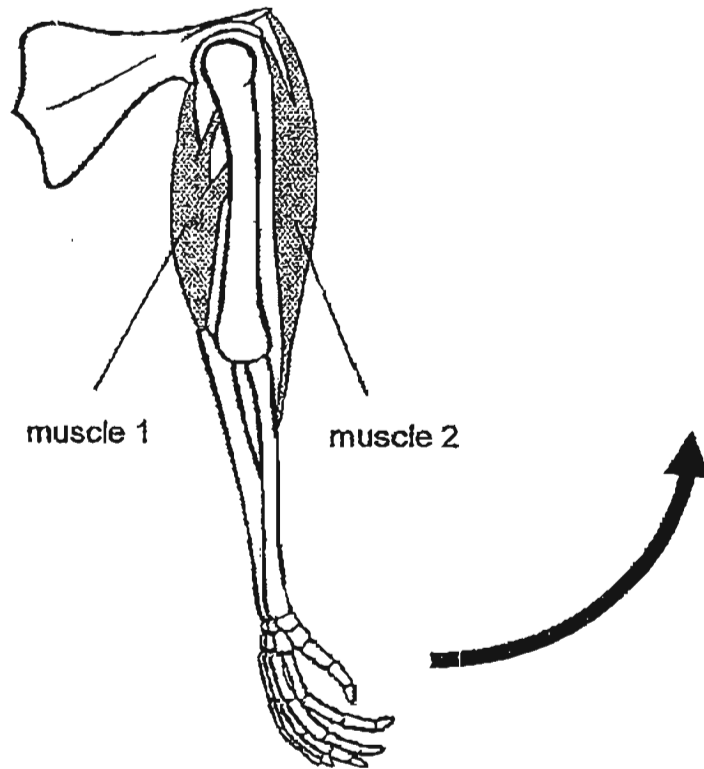

(a) Indicate with a tick (✓) in the table below, which muscle contracts and which muscle relaxes to enable the arm to bend in the direction shown. [1]

	contracts	relaxes
muscle 1		
muscle 2		

(b) Based on the setting above, state the function of the muscular and skeletal systems. [2]

muscular system: \_\_\_\_\_

\_\_\_\_\_

skeletal system : \_\_\_\_\_

\_\_\_\_\_

-----END OF PAPER-----





# ANSWER SHEET

**EXAM PAPER 2011**

**SCHOOL : NANYANG  
SUBJECT : PRIMARY 3 SCIENCE**

**TERM : SA 2**

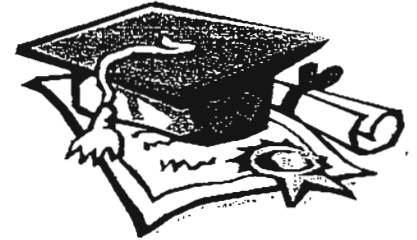

**Booklet A**

Q1	Q2	Q3	Q4	Q5	Q6	Q7	Q8	Q9	Q10	Q11	Q12	Q13	Q14	Q15	Q16	Q17
4	1	3	2	5	3	3	1	3	2	4	3	4	4	3	4	2

Q18	Q19	Q20	Q21	Q22	Q23	Q24	Q25	Q26	Q27	Q28	Q29	Q30
3	3	2	1	4	2	3	1	2	3	4	1	2

**Booklet B**

**31 a) Part B makes food for the plant, if part B is removed , there will be no food for the plant.**

**b) The stem**

**32 a) i)**

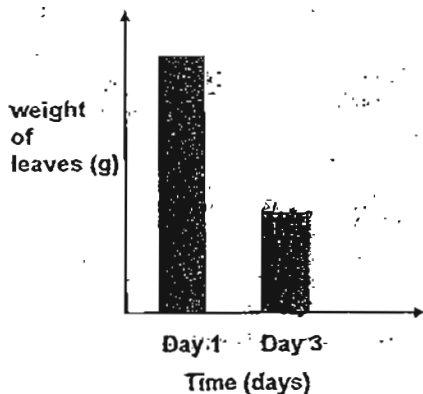

**(a) ii) the caterpillar ate the leaves.**

**32 b) The caterpillar will grow heavier, because it has grown.**

**33 a) i) A bird's nest fern.**

**a) ii) Mango tree.**

33 b) Do they have flowers ?

33 c) It is not a plant.

34 a) Produces milk to feed its young.

b) Hair

c) Area A . Cows need water and food.

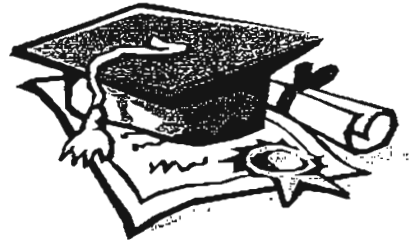

34 a) Elastic

b) Part Q must be opaque

35 a) Metal

Hard

b) Rubber

Waterproof

c) Rubber

Waterproof / light

36 a) Metal

Hard

b) Rubber

Waterproof

c) Rubber

Waterproof / light

37 a) She was trying to identify whether object A or B can attract paper magnets clips.

b) Object A. It has more magnetic strength than object B.

38 a) i) set-up C and D

ii) set-up D. It has the most number of batteries.

(b) i) Set-up B and D

ii) Set-up D. It has the most coils around it.

39)

	TRUE	FALSE	Not possible to tell
Magnet A is stronger than Magnet C			✓
Magnet D is stronger than Magnet B	✓		
Magnet A is as strong as Magnet B		✓	
Magnet C is the weakest magnet			✓

40) a) Plant A will die and plant B will live. Plant A's leaves are covered and did not receive sunlight, leaves make food for the plant.

b) It helps the plant get sunlight.

41) the roots at the plant was able to hold the soil together thus the soil was not easily removed.

43 a) X : Nose                      Y : windpipe

b) the human cannot breathe, living things need air.

44 a)

	contracts	relaxes
muscle 1		✓
muscle 2	✓	



b) muscular system : help the body move

skeletal system : works with the muscular system to help the body move.

--- end of paper ----