



Rosyth School
End-of-Year Examination 2022

SCIENCE

Primary 3

Name: _____

Total

Marks:

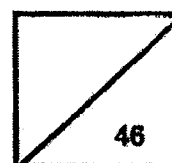

Class: Pr 3- _____

Register No. _____

Total time for Booklets A and B: 1 h 30 min

Date: 28 October 2022

Booklet A

Instructions to Pupils:

1. Do not open the booklet until you are told to do so.
2. Follow all instructions carefully.
3. This paper consists of 2 booklets, Booklet A and Booklet B.
4. For questions 1 to 23 in Booklet A, shade the correct ovals on the Optical Answer Sheet (OAS) provided using a 2B pencil.

For each question from 1 to 23, four options are given. One of them is the correct answer. Make your choice (1, 2, 3 or 4). Shade the correct oval (1, 2, 3 or 4) on the Optical Answer Sheet. (46 marks)

- 1 The diagram below shows a characteristic of living things.

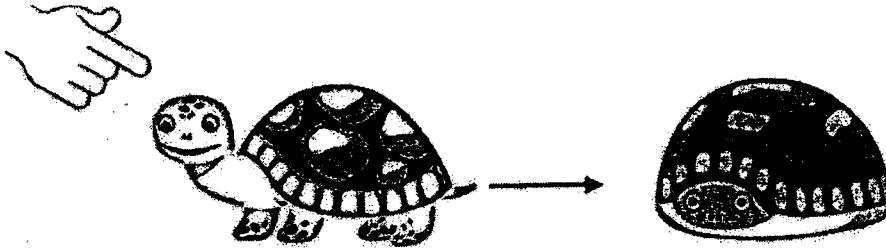

Which statement best describes this characteristic?

- (1) Living things can grow.
 - (2) Living things can reproduce.
 - (3) Living things can respond to changes.
 - (4) Living things need air, food and water to survive.
- 2 The diagram shows an animal.



Which group of living things does the animal belong to?

- (1) fish
- (2) reptile
- (3) mammal
- (4) amphibian

3 Which of the following is/are non-living thing/s?

	Can it move from one place to another?	Can it make its own food?	Can it grow?
A	No	Yes	Yes
B	Yes	No	No
C	No	No	No
D	Yes	No	Yes

- (1) C only
- (2) D only
- (3) A and D only
- (4) B and C only

4 Fungus can affect the nails.



Which statement does **NOT** help to prevent nail fungus?

- (1) Keep the nails trimmed and clean.
- (2) Dry the feet thoroughly after wash.
- (3) Wear sandals as much as possible.
- (4) Wear nylon socks throughout the day.

5 The diagram below shows a human system.

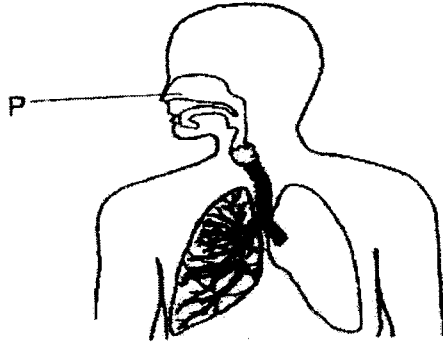

What is the function of P in the above human system?

- (1) To exchange gases
- (2) To allow air to enter only
- (3) To allow air to enter and leave the body
- (4) To absorb oxygen and remove carbon dioxide

6 Study the classification chart below showing the human systems.

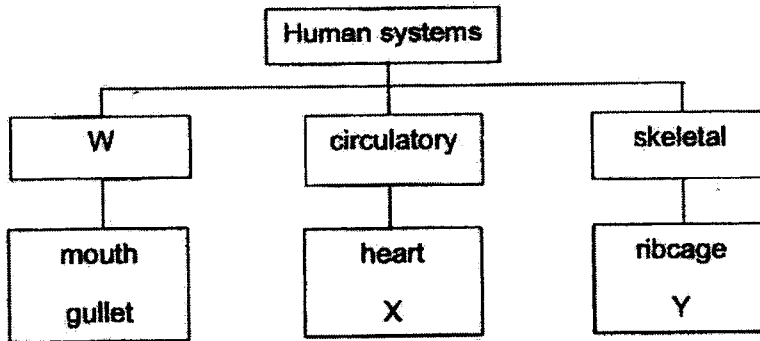

Based on the chart, which of the following best represents W, X and Y?

	W	X	Y
(1)	respiratory	muscles	spine
(2)	muscular	small intestine	muscles
(3)	digestive	blood	lungs
(4)	digestive	blood vessels	skull

- 7 Study the diagram below carefully. Stoma is an opening made to the large intestine during a surgery. The bag collects the waste matter which passes from the large intestine through the stoma.

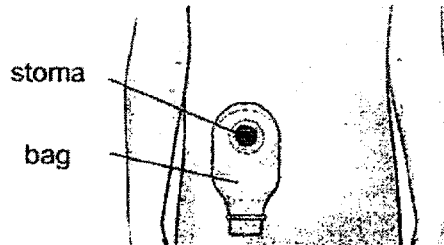

Which of the following are the best properties for the bag?

- (1) light and waterproof
- (2) strong and absorbent
- (3) heavy and absorbent
- (4) heavy and waterproof

- 8 The diagram below shows the human digestive system.

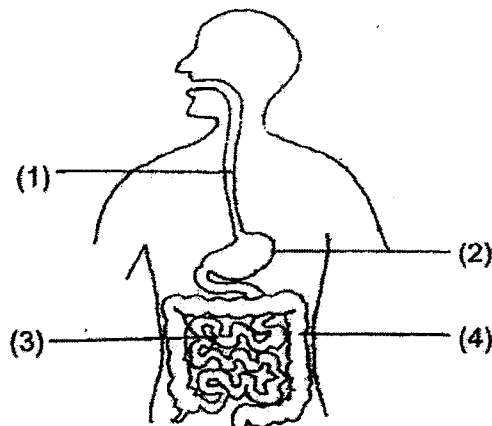

Which part (1, 2, 3 or 4) absorbs the most digested food into the bloodstream?

- 9 The graph below shows the amount of three types of undigested food, X, Y and Z before entering the human digestive system.

At the start:

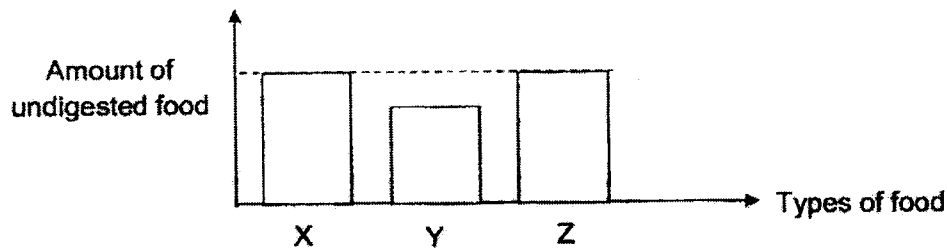

The graphs below show the amount of each type of undigested food left in the mouth and stomach just before leaving each part.

In the mouth:

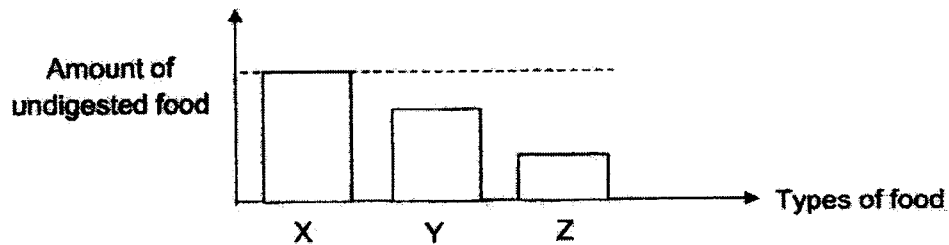

In the stomach:

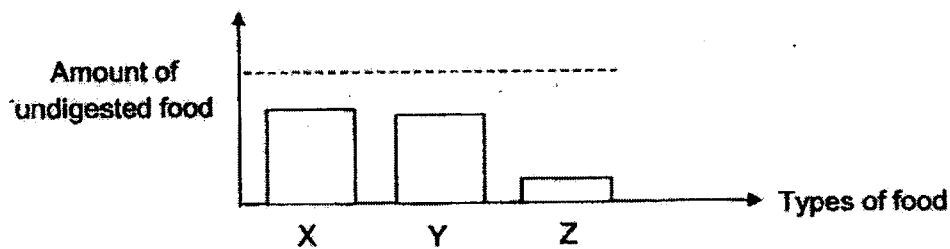

Which type of foods, X, Y and/or Z, only start(s) being digested in the stomach?

- (1) X only
- (2) Z only
- (3) X and Z
- (4) X, Y and Z

- 10 Study the diagram below. It shows the amount of meat that is digested with different amount of chewing.

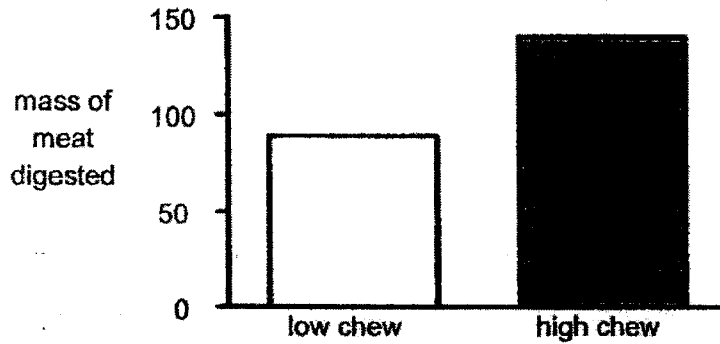

What is the possible reason for different amount of meat that is digested?

- (1) Chewing cuts the meat into tiny pieces.
 - (2) Chewing digests the meat into digested food.
 - (3) Low chewing increases the temperature of the meat.
 - (4) High chewing increases the time the meat is stored in the stomach.
- 11 The diagram below shows a plant.

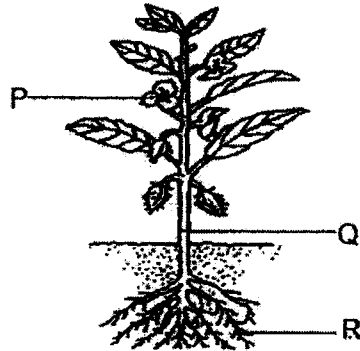

Which of the following correctly represents the part P, Q and R?

	P	Q	R
(1)	Fruit	leaf	stem
(2)	Fruit	root	leaf
(3)	Flower	fruit	leaf
(4)	Flower	stem	root

- 12 The flowchart below describes the functions of different parts of a plant.

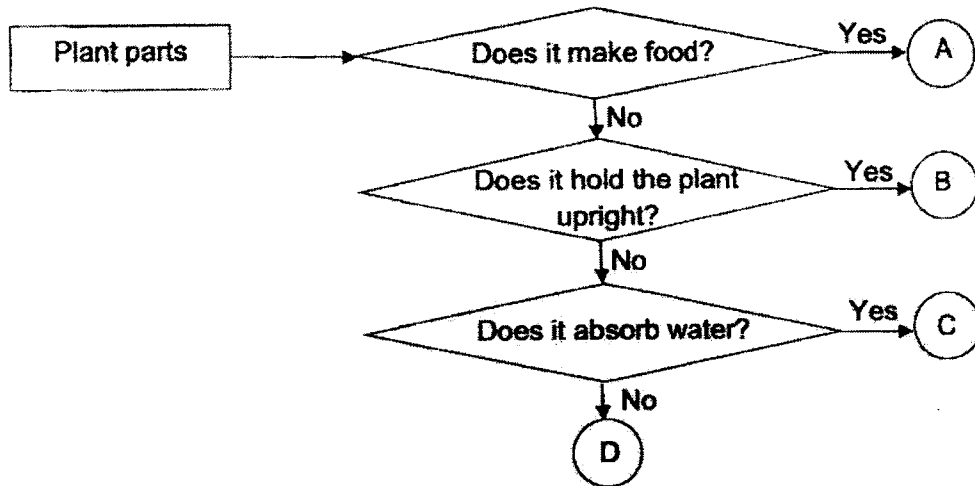

Which one of the following parts, A, B, C or D, best represents the stem?

- (1) A
 - (2) B
 - (3) C
 - (4) D
- 13 Peter waters the plant by spraying water on the flower daily because plants need water to stay alive.

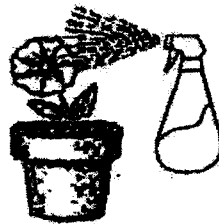

Which one of the following statements best explains how the plant takes in water?

- (1) The plant takes in water through the flower.
- (2) The water drips from the flower to the stem for the stem to transport.
- (3) The water drips from the flower to the soil so that the roots can take in.
- (4) The water drips from the flower to the leaves so that the leaves can take in.

14 Randy cut out card A and card B to make a toy as shown below.

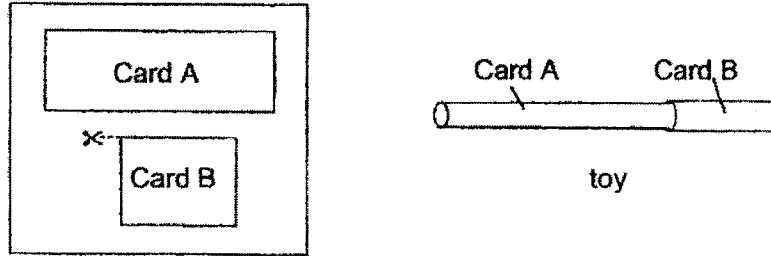

The card could be rolled without tearing. Why is this so?

- (1) The card is strong.
- (2) The card is flexible.
- (3) The card is absorbent.
- (4) The card is waterproof.

15 The flowchart below shows the classification of different objects made from different materials.

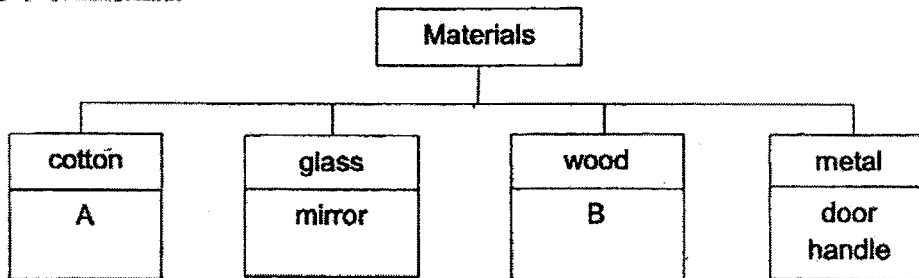

Based on the classification, what are object A and object B likely to be?

	A	B
(1)	cloth	spectacle lens
(2)	shirt	paper
(3)	balloon	table
(4)	handbag	paper clip

- 16 The picture below shows four similar objects of the same size in a container of water. They are made of different materials, W, X, Y and Z.

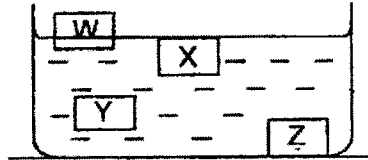

Which material is the most suitable for making a swimming float?



- (1) W
- (2) X
- (3) Y
- (4) Z

- 17 Zoe had four different pieces of materials, P, Q, R and S, of the same size and thickness. She set up an experiment as shown below. She poured 100ml of water onto each of the material.

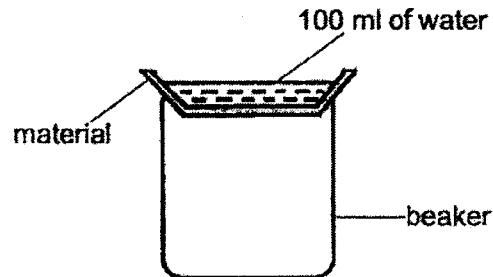

After five minutes, Zoe recorded her findings in the table below.

Material	Amount of water in the beaker (ml)	Amount of water collected above the material (ml)
P	0	100
Q	10	0
R	50	40
S	0	0

The picture below shows a sieve. Part X and part Y are made of the same material.

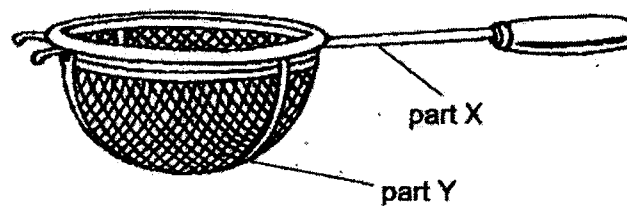

Based on the experiment above, which material is the most suitable to make part X and part Y of the sieve which is used to separate food from the soup?

- (1) P
- (2) Q
- (3) R
- (4) S

- 18 Two magnets, A and B, were placed close together with their north poles facing each other as shown below.

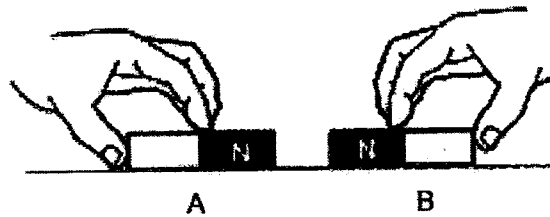

When both magnets were released, they moved along the surface of a table. Which one of the following diagrams shows the correct observation?

- (1)
- (2)
- (3)
- (4)

- 19 The diagram below shows a magnet which is freely suspended from a retort stand.

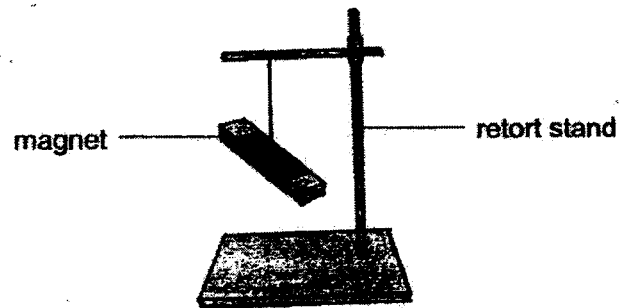

In which direction would the magnet point when it comes to rest?

- (1) East-West
 (2) South-East
 (3) South-West
 (4) North-South

20 The diagram below shows a flowchart.

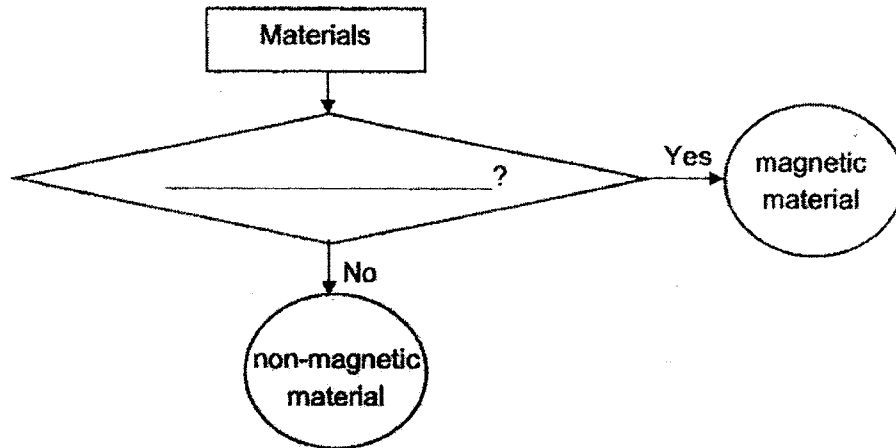

Which one of the following is the missing question in the flowchart?

- (1) Is it a metal?
- (2) Is it waterproof?
- (3) Can it be made into a magnet?
- (4) Can it be repelled by a magnet?

21 The diagram below shows a bar magnet which is lowered onto a tray of steel pins.

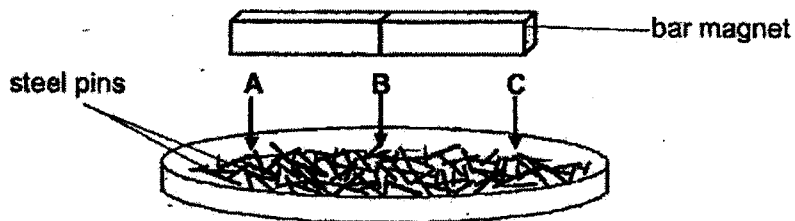

Which of the following shows the most likely number of steel pins attracted to the magnet at A, B and C?

Number of steel pins attracted at A, B and C			
	A	B	C
(1)	9	9	9
(2)	1	1	15
(3)	9	1	9
(4)	15	9	9

- 22 Study the set-up below.

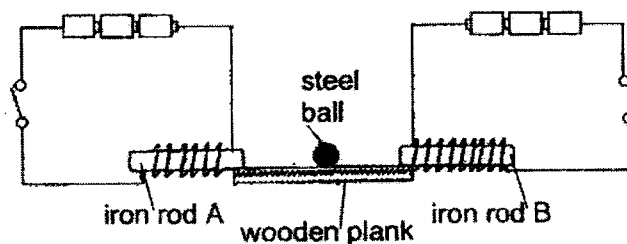

What will happen to the steel ball when the switches are closed at the same time?

- (1) The steel ball will move towards iron rod A.
 - (2) The steel ball will move towards iron rod B.
 - (3) The steel ball will remain at the same position.
 - (4) The steel ball will move towards iron rod B and then towards iron rod A.
- 23 Jill rolled a rubber ball from point P at a low speed past a strong magnet on a table in the direction as shown below. She next rolled an iron ball from point P in the same way.

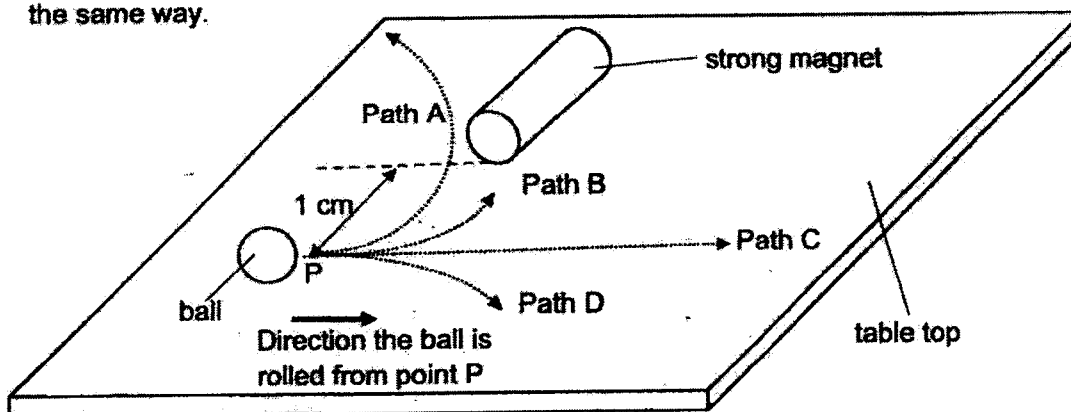

Which paths, A, B, C and D, would the rubber ball and iron ball most likely to roll?

	Rubber ball	Iron ball
(1)	A	D
(2)	C	A
(3)	C	B
(4)	B	D



Rosyth School
End-of-Year Examination 2022

SCIENCE

Primary 3

Name: _____

Pr 3- _____

Total time for Booklets A and B: 1 h 30 min

Date: 28 October 2022

Parent's Signature: _____

Total

Marks:

Register No. _____

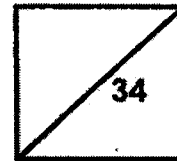

Booklet B

Instructions to Pupils:

1. For questions 24 to 34, write your answers in the spaces given in this booklet.

	Maximum marks	Marks obtained
Booklet A	46	
Booklet B	34	
Total	80	

* This booklet consists of 14 printed pages (including cover page).

This paper is not to be reproduced in part or whole without the permission of the Principal.

For questions 24 to 34, write your answers in this booklet.

(34 marks)

- 24 Devi kept a healthy pot of plant in a black box with a small hole. After two weeks, she found the plant growing towards the opening of the black box.

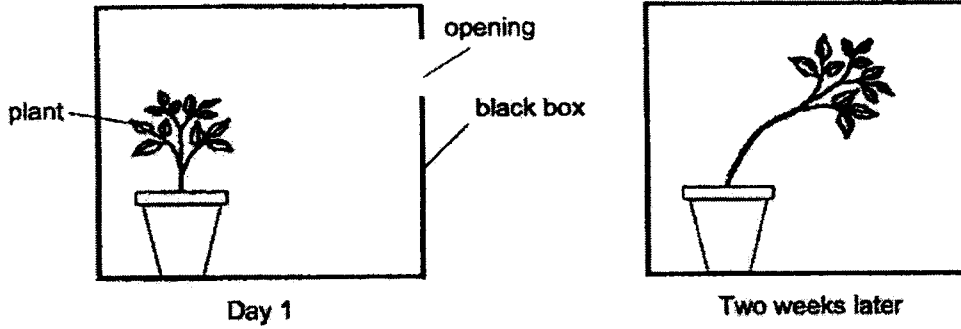

Based on your observations in the diagrams above, state two characteristics of plants that Devi had observed. [2]

Characteristic 1:

Characteristic 2:

25 Study the flowchart below.

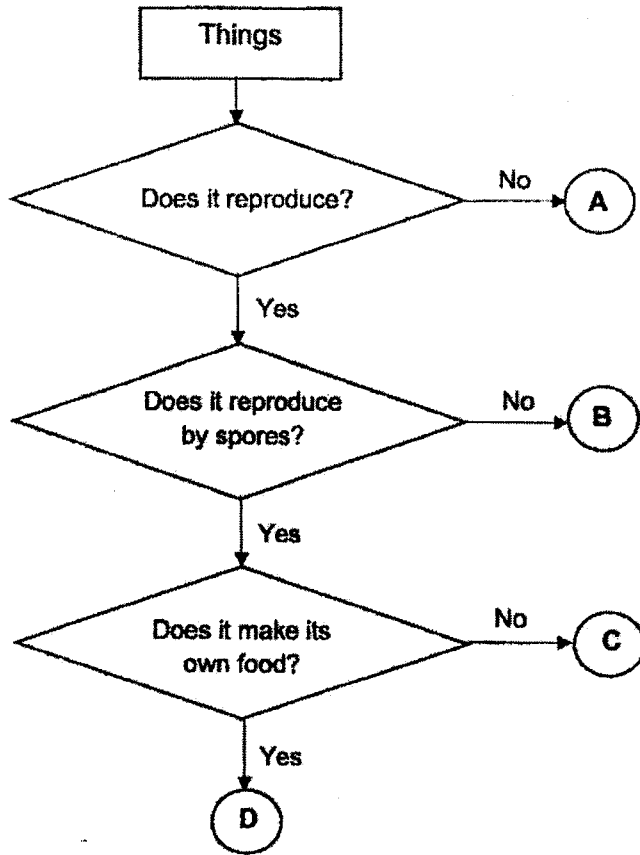

(a) Which of the above letters, A, B, C and D, best represent the following? [2]

fern	
mushroom	
paper	
tree	

(b) According to the flowchart above, state one difference between B and D. [1]

26 (a) Match the following diagrams to the correct human system.

[2]



● circulatory system

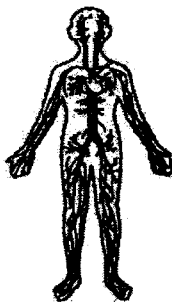

● muscular system

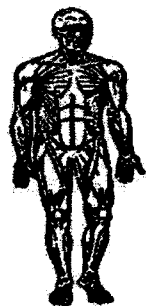

● respiratory system

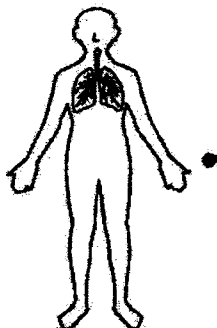

● skeletal system

Question 26 continues on the next page

(b) Three students made the following statements about a human system.

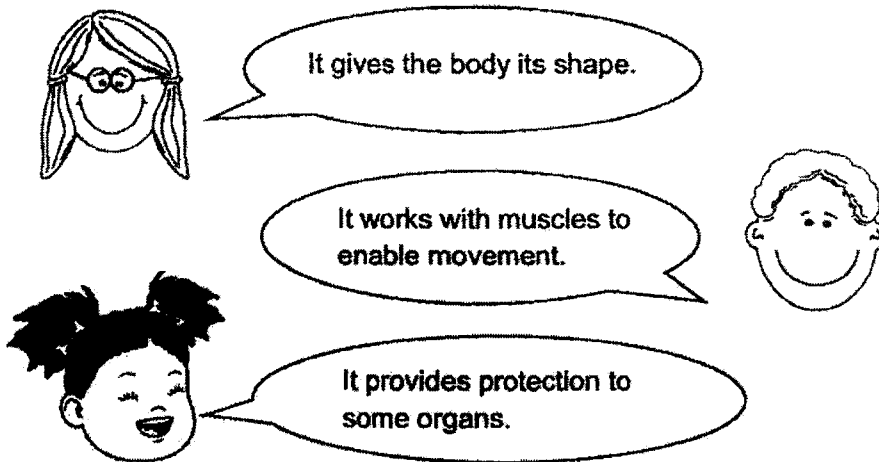

Name a human system which best represents the students' descriptions. [1]

- 27 Jane had some food for lunch.
The graph below shows the amount of food digested in different parts, V, W, X, Y and Z, of her digestive system.

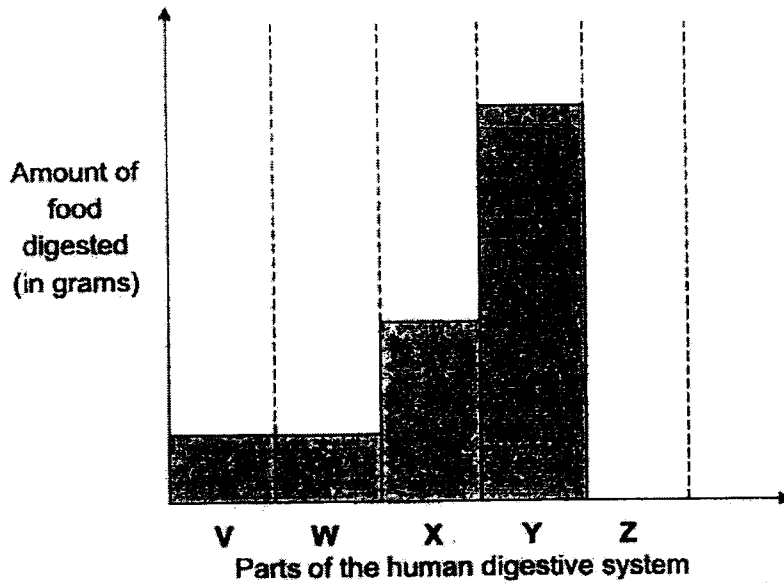

- (a) Name the parts, V, W, X and Y, of the human digestive system.

[2]

V	
W	
X	
Y	

- (b) Jane made a claim.

"There is no digestion taking place in part Z of the human digestive system."
Do you agree with Jane? Use the graph to support your answer.

[1]

28 Zhi Ang set up an experiment on two similar plants as shown below. He wrapped the roots of one of the plants with a plastic bag and observed the water levels in both flasks daily.

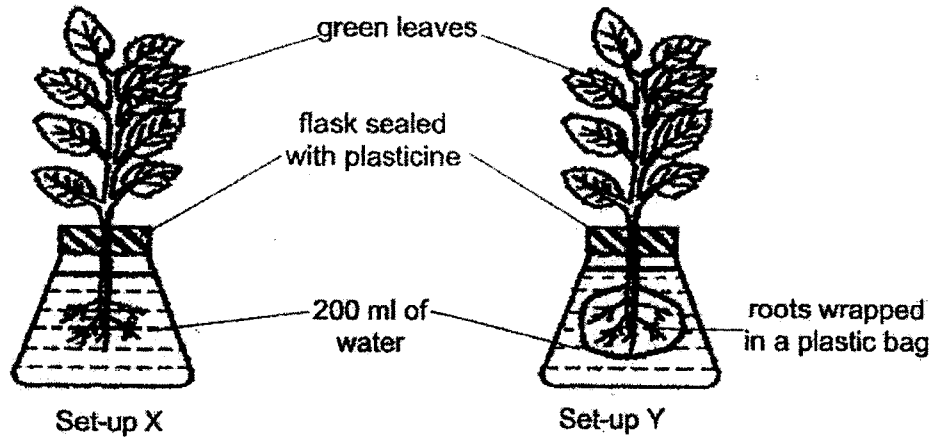

(a) What would Zhi Ang observe about the water level in the flasks in both set-ups after 10 days. Tick (✓) in the correct boxes. [1]

Water level	Increase	Decrease	Remain the same
Set-up X			
Set-up Y			

(b) Give a reason for Zhi Ang's observation of the water level of set-up Y in (a). [1]

(c) Describe the appearance of the leaves of the plant in Set-up Y after ten days. [1]

29 An experiment was carried out on five bags, A, B, C, D and E to find out which bag was the strongest. Each bag was filled with canned drinks, one at a time.

The bar graph below shows the greatest number of canned drinks each bag can hold just before it breaks.

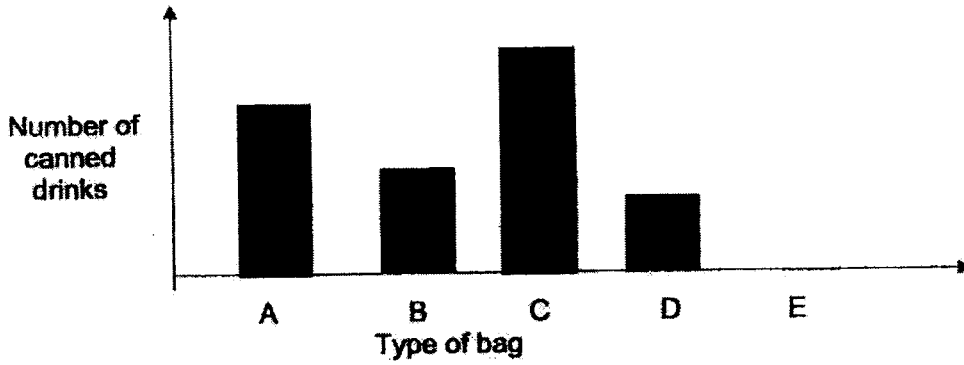

Bag E is not as strong as bag D.

(a) Draw the bar for bag E in the bar graph above. [1]

(b) Which bag A, B, C, D or E is the strongest? Explain your answer. [1]

30 The flowchart below shows the characteristics of materials, P, Q, R and S.

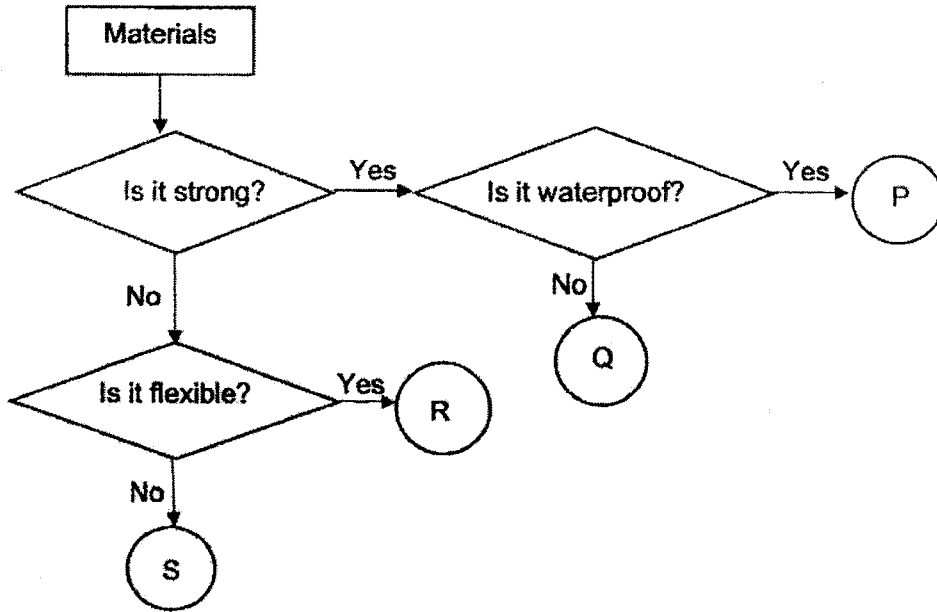

(a) State all the characteristics of material S. [2]

(b) State a similarity between material P and Q. [1]

The picture below shows a wheelbarrow which is used to transport sand and bricks at construction sites.

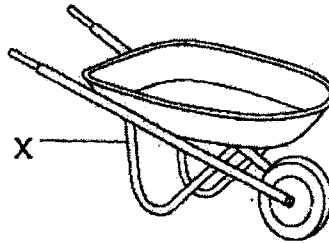

(c) Identify a suitable material, P, Q, R or S, that can be used to make Part X of the wheelbarrow. [1]

Material chosen to make Part X : _____

- 31 Peter conducted an experiment to test a property of four different materials, J, K, L and M. The materials of the same size and shape were lowered into a basin of blue-coloured water.

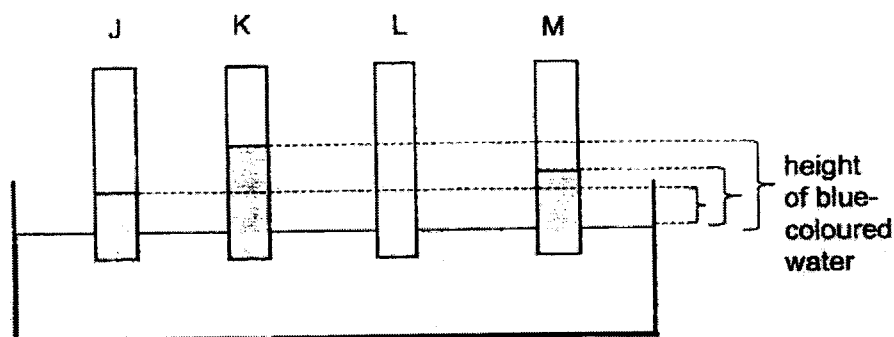

The height of the blue-coloured water on the material was measured after three minutes and the results were recorded in the table below.

Material	Height of blue-coloured water on the material after three minutes (cm)
J	6
K	12
L	0
M	8

- (a) Based on the results above, arrange materials, J, K, L and M, from the most absorbent to the least absorbent. [1]

Most absorbent $\xrightarrow{\hspace{10em}}$ Least absorbent

- (b) Explain why the height of the blue-coloured water on material L was 0 cm. [1]

- (c) Based on the results above, which material J, K, L or M is the most suitable for making a mop? Explain your answer. [2]

32 All made a game using the objects shown below. The lower end of each bar was used for catching fish. The fishing rods were lowered towards each fish A, B and C.

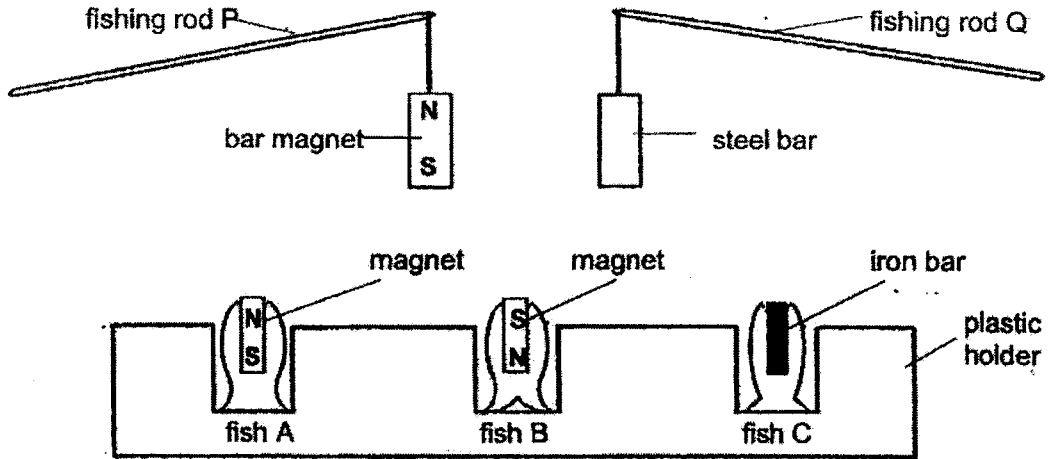

Study the diagram above and put a tick (✓) the correct boxes below. [2]

Statement	True	False	Not possible to tell
(a) Fishing rod P can catch fish A, B and C.			
(b) Fishing rod Q can catch fish A and B only.			

33 Jack did a set-up as shown below.

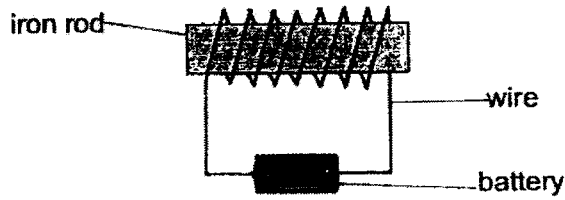

(a) What type of magnet was shown in the above set-up? [1]

When the set-up was placed near a bar magnet, the bar magnet moved away as shown in the diagram below.

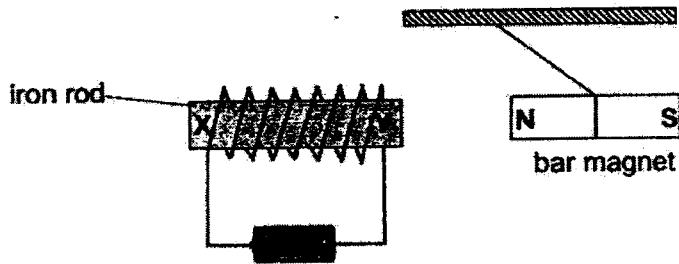

(b) Identify the pole X and Y by writing 'N' or 'S' in the blanks below. [1]

X : _____

Y : _____

(c) What will happen to the bar magnet when the battery is removed from the set-up? [1]

(d) Describe how the iron rod can be made into a magnet without using the coils of wire and battery. [1]

- 34 Raj conducted an experiment with three u-shaped magnets, J, K and L, to find out their magnetic strength.

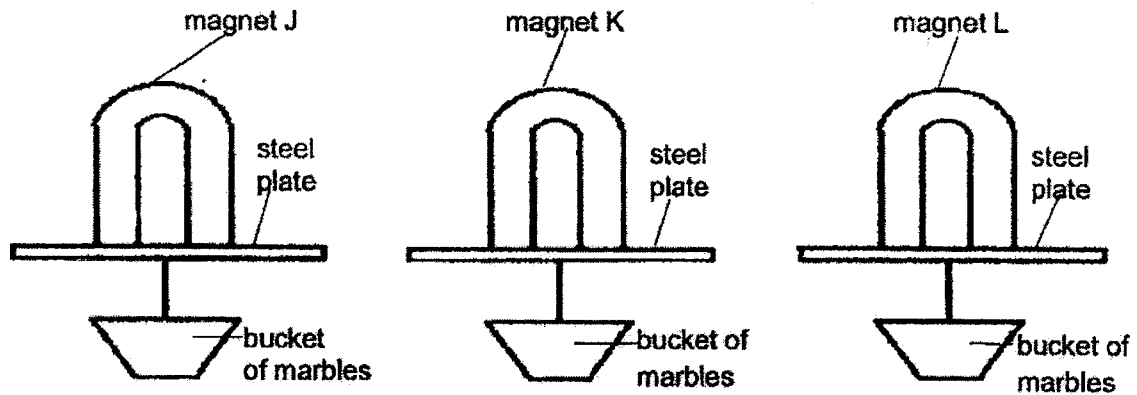

- (a) Indicate the poles of magnet J by writing 'N' and 'S' on magnet J in the diagram above. [1]

The results of Raj's experiment are shown in the table below.

Magnet	Number of marbles in the bucket before the steel plate dropped
J	31
K	25
L	18

- (b) Based on the table above, which magnet has the greatest magnetic strength? [1]

Magnet _____

Question 34 continues on the next page

- (c) Raj had a mixture of three types of small objects, P, Q and R, made of different materials in a container as shown in the diagram below.



The properties of three objects, P, Q and R, are given in the table below.

Object	Can it sink?	Is it a magnetic material?
P	No	Yes
Q	Yes	No
R	Yes	Yes

Raj wanted to obtain the objects, P, Q and R, separately as shown in the diagram below.



Fill in the blanks using 'P', 'Q' or 'R' to describe how Raj could separate the objects. Each letter 'P', 'Q' or 'R' may be used more than once. [2]

Step 1:	Fill the container with water to the brim.
Step 2:	_____ will float. Use the magnet in (b) to remove them out of the container from the surface of the water.
Step 3:	Pour away all the water in the container. Only _____ and _____ are left in the container.
Step 4:	Use the magnet in (b) to attract _____
Step 5:	Only _____ is left in the container.

End of Paper

SCHOOL: ROSYTH SCHOOL

SUBJECT: SCIENCE

LEVEL: PRIMARY 3

PAPER: SA2

BOOKLET A

3	1	4	4	3	4	1	3	1	1
4	2	3	2	2	1	-1	4	4	3
3	2	3							

BOOKLET B

Q24. Characteristic 1: Plants respond to changes

Characteristic 2: Plants grow

Q25. a) D, C, A, B

b) D reproduces by spores but B does not.

Q26. a)

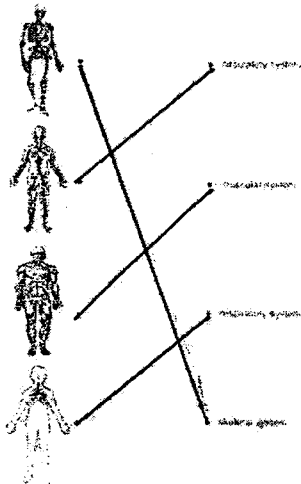

b) Skeletal system

Q27. a) mouth, gullet, stomach, small intestine

b) Yes. Digested food was not present in Z, which shows that it is the large intestine. Digestion does not take place in the large intestine.

Q28. a) X: Decrease

Y: Remain the same

b) The roots were wrapped in the plastic bag, hence water cannot be absorbed.

c) They will turn brown.

Q29. a)

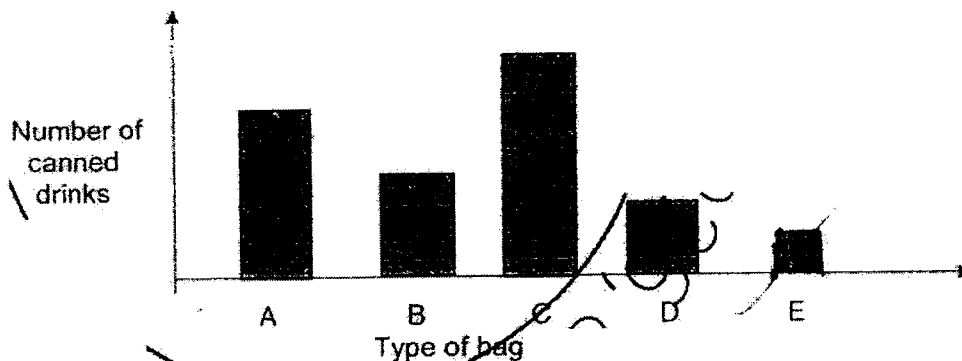

b) Bag C. It held the most number of canned drinks, showing that it is made of the strongest material.

Q30. a) It is not strong and is flexible

b) Both are strong.

c) P

Q31. a) K, M, J, L

b) It did not absorb any water

c) K. The height of the blue-coloured water was the highest, which shows that it is the most absorbent, which is most suitable for a mop.

Q32. a) False

b) True

Q33. a) Electromagnet

b) X: S

Y: N

c) It will move towards the iron rod.

d) Stroke the iron rod with the same pole of a bar magnet.

Q34. a)

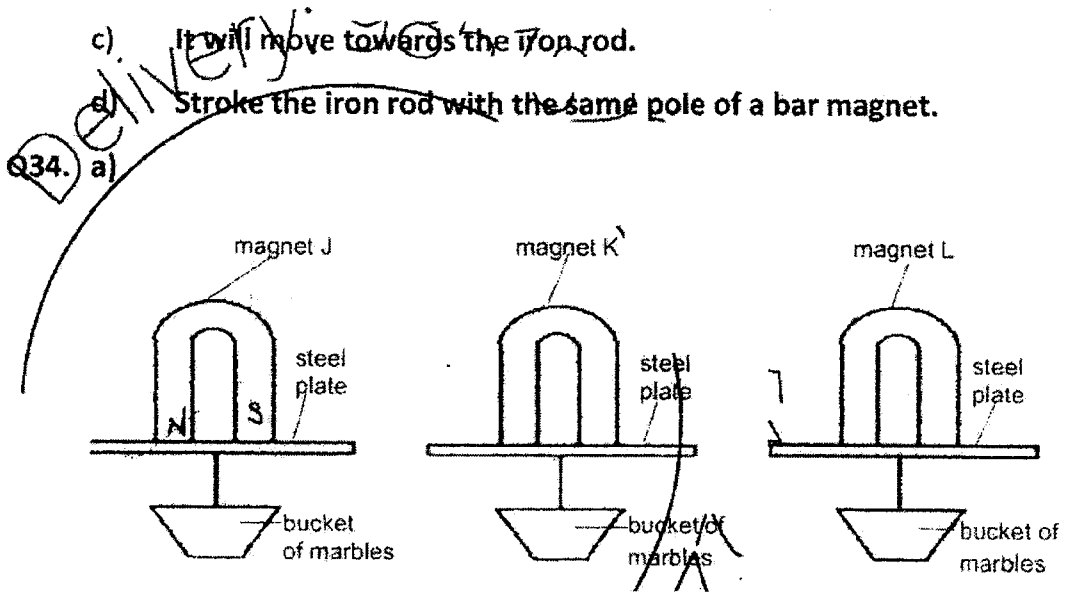

b) J

Step 2: P

Step 3: Q, R

Step 4: R

Step 5: Q

