

Name : \_\_\_\_\_ ( )

Class : Primary 4 \_\_\_\_\_

## CHIJ ST NICHOLAS GIRLS' SCHOOL



Primary 4

First Semestral Examination 2009

Mathematics

12 May 2009

Booklet A

Duration of Paper : 1 h 45 min

Do not open the booklet until you are told to do so.  
Follow all instructions carefully

This booklet consists of 6 printed pages including the cover page.



7. There were a number of children in the hall. The teacher was able to divide the children equally into groups of 4 or 7. How many children were there?

- 1) 112
- 2) 124
- 3) 144
- 4) 152

8. The factors of a given number are listed below. What are the missing factors in the blanks?

1, 2, 3, 4,   ?  , 8, 12, 16,   ?  , 48

- 1) 5 and 20
- 2) 6 and 24
- 3) 6 and 32
- 4) 7 and 32

9. A luggage cost three times as much as a haversack. If Gordon spent \$2 736 on 2 such luggage and 3 such haversacks, how much did 1 luggage cost?

- 1) \$304
- 2) \$608
- 3) \$912
- 4) \$1 824

10. A machine produced 7 560 toys in 9 days. If it produced the same number of toys in a day, how many toys would the machine be able to produce in a week?

- 1) 840
- 2) 1 080
- 3) 5 880
- 4) 9 720

11. ABCD is a rectangle. Find  $\angle ABD$ .

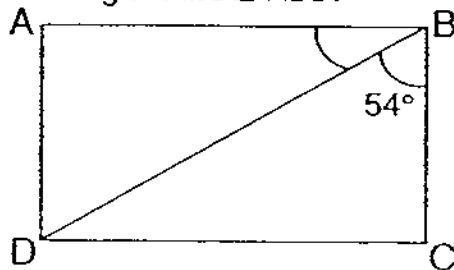

- 1) 36°
- 2) 45°
- 3) 54°
- 4) 90°

12. STUV is a rectangle. Its length is 4 times as long as its breadth. What is the perimeter of the rectangle?

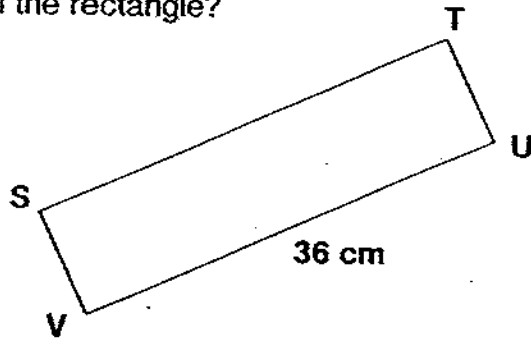

- 1) 90 cm  
2) 144 cm  
3) 324 cm  
4) 360 cm
13. A piece of wire 90cm long is bent into the following shape. PQRS is a square. ST is equal to TP and TP is equal to SP. What is the length of the square?

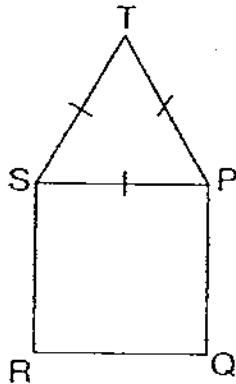

- 1) 18 cm  
2) 15 cm  
3) 10 cm  
4) 9 cm
14. The area of a rectangular plot of land is  $224 \text{ m}^2$ . If its breadth is 4 m, find its length.
- 1) 56 m  
2) 108 m  
3) 110 m  
4) 896 m

15. How many sixths are there in  $4\frac{2}{3}$  ?

1) 12

2) 14

3) 22

4) 28

16. STUV is a square with an area of  $100\text{ cm}^2$ . What is the area of the shaded part?

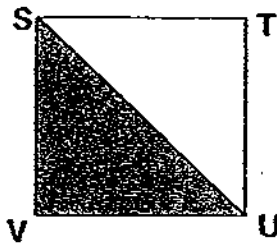

1)  $25\text{ cm}^2$

2)  $40\text{ cm}^2$

3)  $50\text{ cm}^2$

4)  $75\text{ cm}^2$

17. Which one of the following has the same answer as  $6\frac{2}{5}$  ?

1)  $5 + \frac{13}{10}$

2)  $6 + \frac{3}{10}$

3)  $5 + \frac{5}{5} + \frac{4}{10}$

4)  $6 + \frac{1}{10} + \frac{1}{5}$

18. What is the difference between  $\frac{7}{12}$  and  $\frac{1}{4}$  in the simplest form?

1)  $\frac{1}{2}$

2)  $\frac{1}{3}$

3)  $\frac{3}{4}$

4)  $\frac{4}{12}$

19. What fraction of the figure is not shaded?

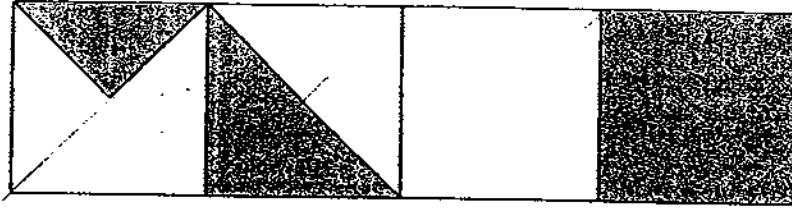

1)  $\frac{7}{16}$

2)  $\frac{9}{16}$

3)  $1\frac{1}{4}$

4)  $1\frac{3}{4}$

20. The table below shows the favourite food of 280 pupils.

Food	No. of pupils
Chicken rice	72
Fish burger	90
Nasi Lemak	?
Roti Prata	?
Vegetable curry rice	46

The number of pupils who like to eat Nasi Lemak is 3 times as many as the number of pupils who like to eat Roti Prata. How many pupils like to eat Nasi Lemak?

1) 18

2) 24

3) 36

4) 54

Name : \_\_\_\_\_ ( )

Class : Primary 4 \_\_\_\_\_

## CHIJ ST NICHOLAS GIRLS' SCHOOL



Primary 4

### First Semestral Examination 2009 Mathematics

12 May 2009

Booklet B

Section A :	/ 40
Section B & C :	/ 60
Total Marks:	/100

\_\_\_\_\_  
Parent's Signature

Duration of Paper : 1 h 45 min

Do not open the booklet until you are told to do so.  
Follow all instructions carefully

This booklet consists of 10 printed pages including the cover page.

**SECTION B : (18 x 2 marks)**

**Write your answers in the blanks provided. Show your working clearly.**

**Leave your answer in the unit stated.**

Do not write in this space

21. In 92 397, what is the difference between the values of the digit 9?

Ans : \_\_\_\_\_

22. What is the sum of 12 hundreds, 55 tens and 34 thousands?

Ans : \_\_\_\_\_

23. A box contains 7 muffins and a tin contains 8 pieces of cookies. Mrs Yeo wants to buy an equal number of muffins and cookies. What is the least number of boxes of muffins and tins of cookies that Mrs Yeo must buy?

Ans : \_\_\_\_\_ boxes of muffins  
\_\_\_\_\_ tins of cookies

24. List the first two common multiples of 8 and 12.

Ans : \_\_\_\_\_ and \_\_\_\_\_

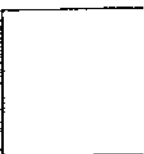



25. Jenny works 9 hours a day. She earns \$24 for every hour she works. How much does she earn if she works for 25 days?

Ans : \$ \_\_\_\_\_

26. What is the quotient of  $6\,054 \div 8$ ?

Ans : \_\_\_\_\_

27. Round off the product of 893 and 46 to the nearest hundred.

Ans : \_\_\_\_\_

28. Number A is 2 800 when rounded off to the nearest hundred and Number B is 7 150 when rounded off to the nearest ten.

- a. What is the greatest possible answer for Number A?
- b. What is the greatest possible sum of the two numbers?

Ans : a) \_\_\_\_\_

b) \_\_\_\_\_

Do not  
write in  
this space

29. What is  $\frac{3}{4}$  of 48?

Ans : \_\_\_\_\_

30. ABCD is a rectangle. Find  $\angle a$ .

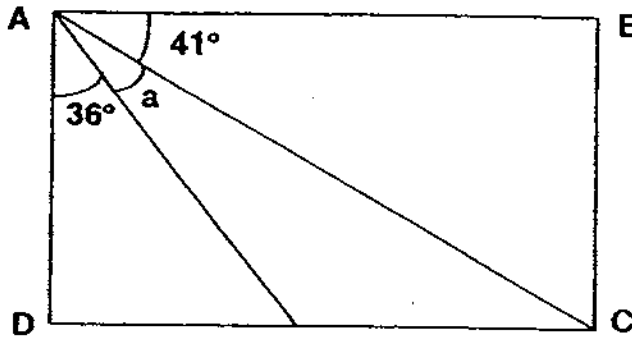

Ans : \_\_\_\_\_°

31. Siti had a collection of stickers. She had fewer than 100 stickers. The number of stickers she had can be pasted equally into a sticker album with 7 pages or 12 pages. What was the greatest possible number of stickers that Siti had?

Ans : \_\_\_\_\_ stickers

32. Study the pattern and find the missing number.

9 360, 1 560, **A**, 78, 26, 13, 13

Ans : A = \_\_\_\_\_

Do not  
write in  
this space



33. Eunice read  $\frac{1}{3}$  of a book on Monday and  $\frac{5}{12}$  of it on Tuesday. What fraction of the book must Eunice read in order to finish reading the book?

Do not write in this space

Ans : \_\_\_\_\_

34. There were 24 children, 15 men and 21 women in a movie theatre. What fraction of the people were adults?

Ans : \_\_\_\_\_

35. Square A has the same area as Rectangle B. What is the perimeter of Rectangle B?

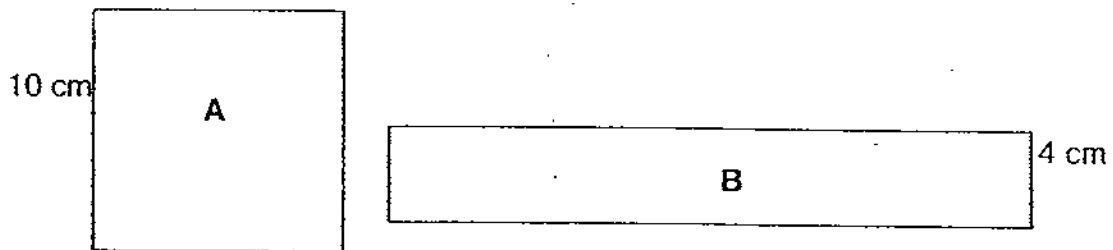

Ans : \_\_\_\_\_ cm



36. What is the missing fraction? Express your answer as an **improper fraction**.

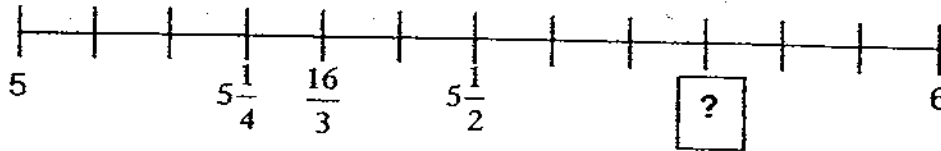

Ans : \_\_\_\_\_

37. Find the perimeter of the figure below. (All the lines meet at right angles.)

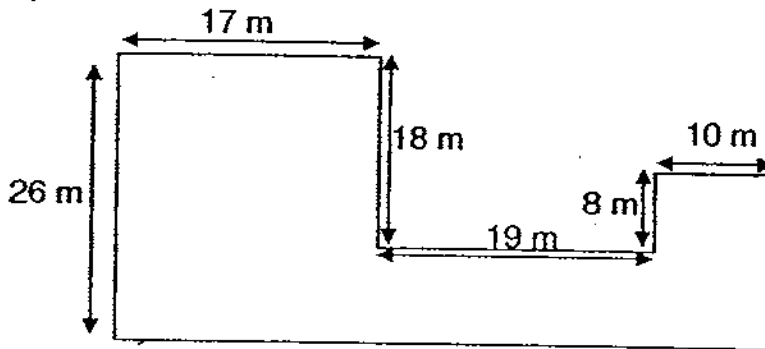

Ans : \_\_\_\_\_ m

38. The table below shows the amount of money each pupil in Primary 4A saved in the month of February. What is the total amount of money saved?

Number of pupil / pupils	Amount of money saved
3	\$0
8	\$12
9	\$14
10	\$16
5	\$18

Ans : \$ \_\_\_\_\_

Do not write in this space



**SECTION C : (6 x 4 marks)**

**Solve the following problems. All mathematical working and statements must be shown clearly.**

39. A packet of marbles cost 40 ¢ less than a rubber ball. If 7 packets of marbles and 3 rubber balls cost \$11.40, what is the cost of 12 such packets of marbles?

Ans : \_\_\_\_\_

40. Emma had \$728 more than Yani. She gave \$365 to Yani. If they had a total of \$3 672, how much did Emma have finally?

Ans : \_\_\_\_\_

Do not  
write in  
this space

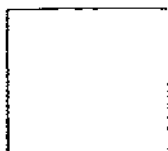

41. John attended a piano recital. In the auditorium, he was led to the fourth row from the stage. There were 6 seats to the right of John and 7 seats to his left. If there were 17 rows behind him, how many seats were there in the auditorium ?

Do not  
write in  
this space

Ans : \_\_\_\_\_

42. Evelyn spent  $\frac{5}{8}$  of her money on new dresses. She had \$261 left. How much money did she have at first?

Ans : \_\_\_\_\_



43. Celine had  $1\frac{2}{3}$  kg of sugar,  $2\frac{1}{3}$  kg of cocoa powder and 3 kg of flour for baking some cupcakes for sale at a carnival.

- a) What is the total mass of all the ingredients she had? Leave your answer in kg.
- b) If the ingredients she had was  $\frac{1}{4}$  of what Celine needed in total, what was the total mass of the ingredients needed?

Do not write in this space

Ans : a) \_\_\_\_\_  
b) \_\_\_\_\_

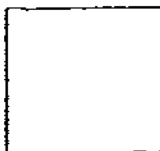

44. Mr Tan makes a path of width 2 m around his rectangular swimming pool. Find the area of the swimming pool.

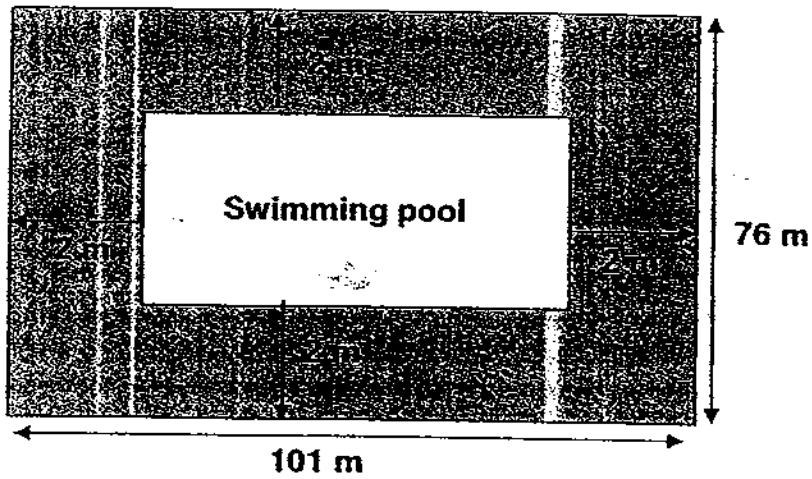

Do not write in this space

Ans : \_\_\_\_\_

**\*\* END OF PAPER \*\***





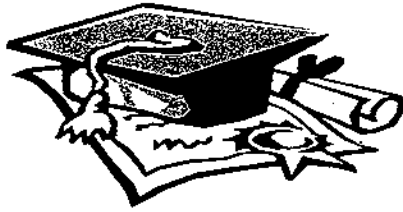

# ANSWER SHEET

**EXAM PAPER 2009**

**SCHOOL : CHIJ PRIMARY SCHOOL**  
**SUBJECT : PRIMARY 4 MATHEMATICS**

**TERM : SA 1**

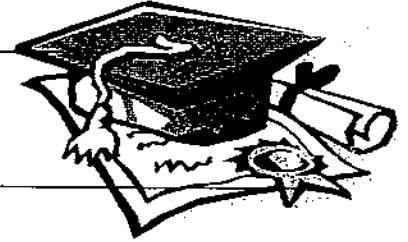

Q1	Q2	Q3	Q4	Q5	Q6	Q7	Q8	Q9	Q10	Q11	Q12	Q13	Q14	Q15	Q16	Q17
3	3	2	2	2	4	1	2	3	3	1	1	2	1	4	3	3

Q18	Q19	Q20
2	2	4

21)89910      22)35750      23)8,7      24)24 and 48      25)\$5400

26)756      27)41100      28)a)2849      b)10003      29)36

30)13°      31)84      32)312      33)  $\frac{1}{4}$       34) $\frac{3}{5}$

35)58cm      36) $23\frac{3}{4}$       37)160m      38)\$472

39)  $3 \times \$40c = \$1.20$

$$\$11.40 - \$1.20 = \$10.20$$

$$3 + 7 = 10$$

$$\$10.20 \div 10 = \$1.02 \text{ (marbles)}$$

$$\$1.02 \times 12 = \$12.24$$

The cost of 12 such packets of marbles is \$12.24.

40)  $\$3672 - \$728 = \$2944$

$$\$2944 \div 2 = \$1472$$

$$\$728 - \$365 = \$363$$

$$\$1472 + \$363 = \$1835$$

Emma had \$1835 finally.

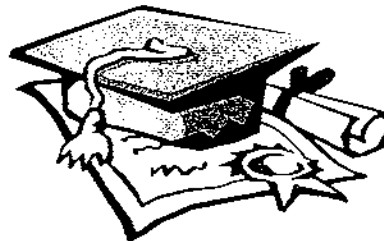

**41)  $6+7=13$**

**$13+1=14$**

**$4+17=21$**

**$21 \times 14=294$**

**There were 294 seats in the auditorium.**

**42)  $1 - 5/8=3/8$**

**$\$261 \div 3=\$87$**

**$\$87 \times 8=\$696$**

**She had \$696 at first.**

**43)a)  $1\frac{2}{3}+2\frac{1}{3}+3=7\text{kg}$**

**The total mass of all the ingredients she had was 7kg.**

**b)  $4 \times 7=28\text{kg}$**

**The total mass of all the ingredients she needed was 28kg.**

**44)  $2+2=4$**

**$76-4=72$**

**$101-4=97$**

**$97 \times 72=6984$**

**The area of the swimming pool is 6984m<sup>2</sup>**

