

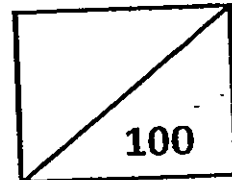

Rosyth School
First Semestral Assessment 2010
Mathematics
Primary 4



Name: _____

Class: Pr 4-_____ Register No.: _____ Duration: 1 $\frac{1}{4}$ h 45 min

Date: 12th May-2010

Parent's Signature: _____

Instructions to Pupils:

1. Do not open this booklet until you are told to do so.
2. Follow all instructions carefully.
3. This paper consists of 3 parts, Sections A, B and C.
4. For questions 1 to 20 in Section A, shade the correct ovals on the Optical Answer Sheet (OAS).
5. ANSWER ALL THE QUESTIONS.

	Maximum	Marks Obtained
Section A	40	
Section B	40	
Section C	20	
Total	100	

* This paper consists of 19 pages altogether.

This paper is not to be reproduced in part or whole without the permission of the Principal.

Section A (40 marks)

For questions 1 to 20, four options are given. One of them is the correct answer. Make your choice (1, 2, 3 or 4). Shade the correct ovals (1, 2, 3 or 4) onto the Optical Answer Sheet provided. Each question carries 2 marks.

1. What is the value of the digit 6 in 36 594?

- (1) 60
- (2) 600
- (3) 6 000
- (4) 60 000

2. What number is the same as 70 thousands, 8 hundreds and 5 tens?

- (1) 785
- (2) 7 850
- (3) 70 805
- (4) 70 850

3. Which one of the following is the best estimate for 22×59 ?

- (1) 20×50
- (2) 20×60
- (3) 30×50
- (4) 30×60

4. What is the common factor of 6 and 9?

- (1) 6
- (2) 2
- (3) 3
- (4) 18

5. Which of the following numbers is a multiple of 3?

- (1) 43
- (2) 56
- (3) 121
- (4) 126

6. $1\frac{1}{6} - \frac{1}{2} =$

- (1) $\frac{2}{3}$
- (2) $\frac{5}{6}$
- (3) $1\frac{1}{8}$
- (4) $1\frac{1}{4}$

7. $12 \square 2 = 48 \div 2$

What is the missing sign in the box?

- (1) +
- (2) -
- (3) ×
- (4) ÷

8. Find the value of $\angle y$ in the rectangle (not drawn to scale) below.

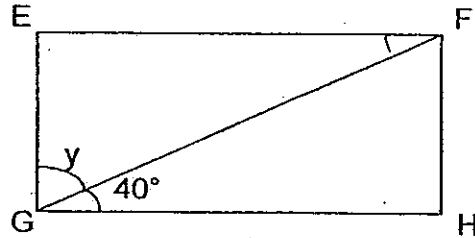

- (1) 40°
- (2) 50°
- (3) 60°
- (4) 90°

- 9.

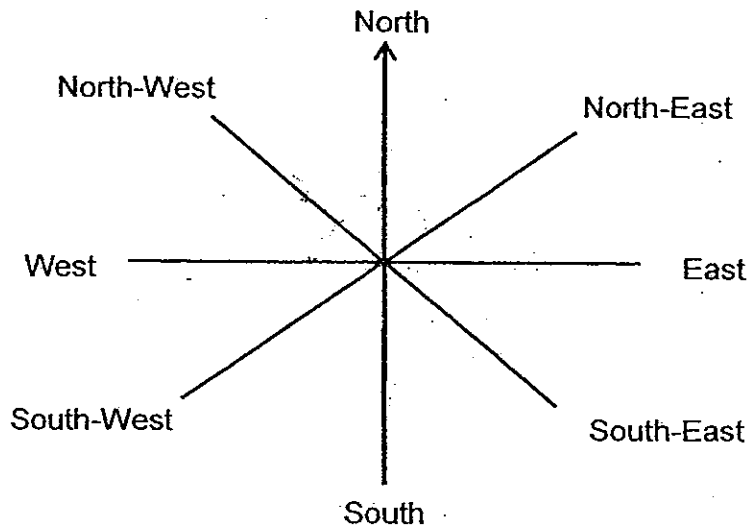

Evon is standing in the middle of the 8-point compass facing North-east. Where will she be facing if she makes a 135° clockwise turn?

- (1) North-West
- (2) West
- (3) South-West
- (4) South

The line graph below shows the number of pies sold in January. Use it to answer questions 10 and 11.

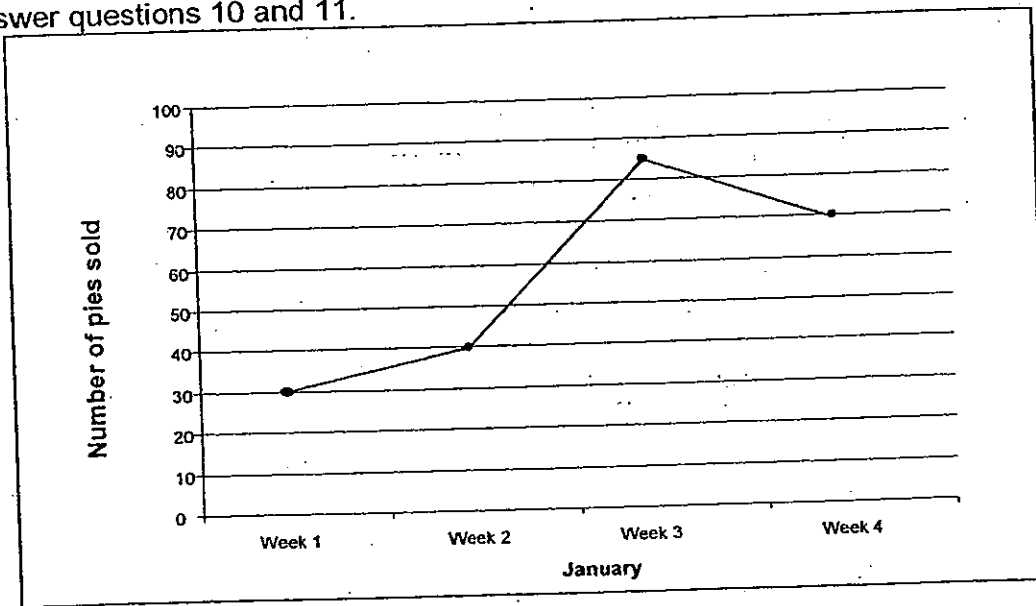

10. What was the total number of pies sold in January?
- (1) 30
 - (2) 85
 - (3) 220
 - (4) 225
11. How many more pies were sold in week 3 than week 1?
- (1) 10
 - (2) 30
 - (3) 55
 - (4) 85
12. What is the quotient when 135 is divided by 3?
- (1) 37
 - (2) 41
 - (3) 45
 - (4) 405

13. 6 burgers were shared equally among 4 children.

What fraction of the burger did each child get?

(1) $\frac{1}{6}$

(2) $\frac{1}{2}$

(3) $1\frac{2}{3}$

(4) $1\frac{1}{2}$

14. Find the value of $\frac{4}{5}$ of 30.

(1) 10

(2) 14

(3) 20

(4) 24

15. How many quarters are there in $4\frac{1}{2}$?

(1) 18

(2) 24

(3) 36

(4) 4

16. In the figure below (not drawn to scale), find the value of $\angle a$.

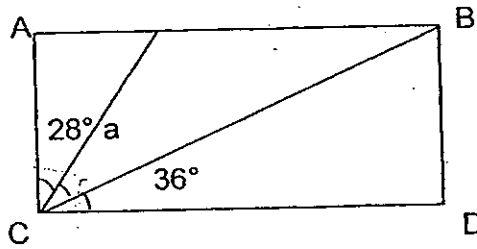

- (1) 24°
 (2) 26°
 (3) 34°
 (4) 36°
17. In the figure below, ABCD is a rectangle and DEFG is a square. Find the length of BG.

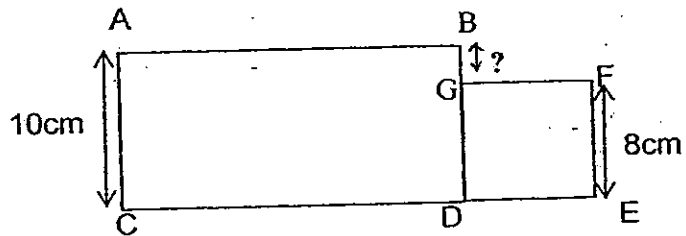

- (1) 7 cm
 (2) 2 cm
 (3) 8 cm
 (4) 10 cm

18. An empty container weighs $\frac{3}{5}$ kg. When it is filled with biscuits, the total mass of the container and biscuits is $\frac{3}{4}$ kg. What is the mass of the biscuits?

(1) 1 kg

(2) $\frac{3}{20}$ kg

(3) $\frac{1}{10}$ kg

(4) $\frac{2}{3}$ kg

19. A pen costs twice as much as a pencil. If a pencil costs \$0.50, what is the cost of 4 pens?

(1) \$1

(2) \$2

(3) \$2.50

(4) \$4

20. May sold lilies for \$4 each. She collected \$336 in a week. If she sold the same number of lilies each day, how many lilies did she sell in a day?

(1) 12

(2) 28

(3) 84

(4) 1344

Section B (40 marks)

For questions 21 to 40, show your working clearly in the space below each question and write your answer in the answer boxes provided. Give your answers in the units stated. Each question carries 2 marks.

21. Find the first common multiple of 4 and 6.

22. Form the greatest four-digit number using all the digits listed below.

6 , 5 , 9 , 0

23. What must be added to 199 to make 1 099?

24. $9 \times \square = 1935$
Find the number in the box.

25. $3\frac{2}{3} - \square = \frac{5}{6}$

Find the missing fraction in the box. Give your answer in its simplest form.

26. The figure below is made up of a square and 2 rectangles. Find the length of EF.

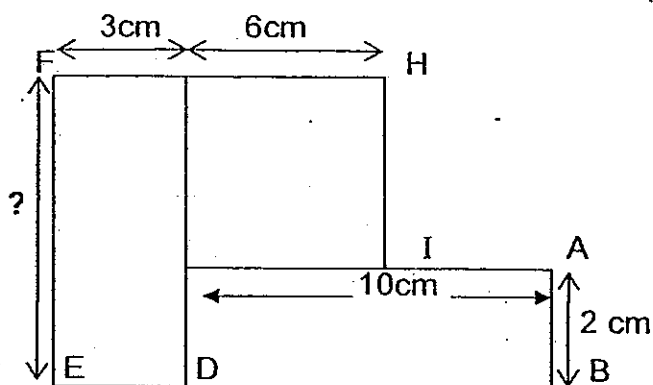
 cm

27. How many right angles are there in the figure below?

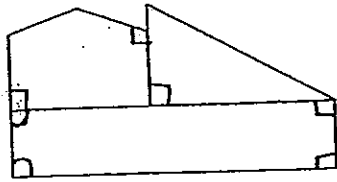

28. Arrange the following fractions in order from the smallest to the biggest.

$\frac{1}{6}$

$\frac{1}{4}$

$\frac{1}{2}$

$\frac{1}{3}$

29. Express $\frac{24}{5}$ as a mixed number.

30. Using the line EF drawn below, draw and label $\angle EFG = 60^\circ$

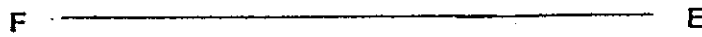

31. Draw a line perpendicular to AB through point C.

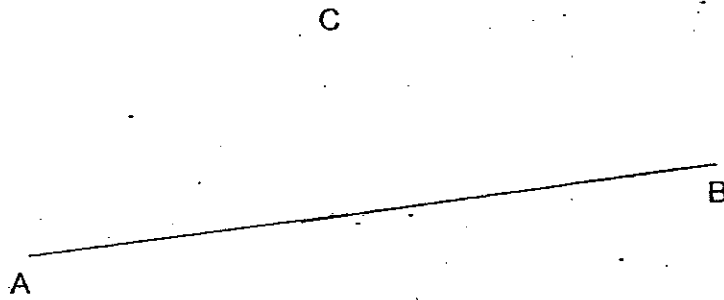

32. In the figure below, name the two lines that are parallel to each other.

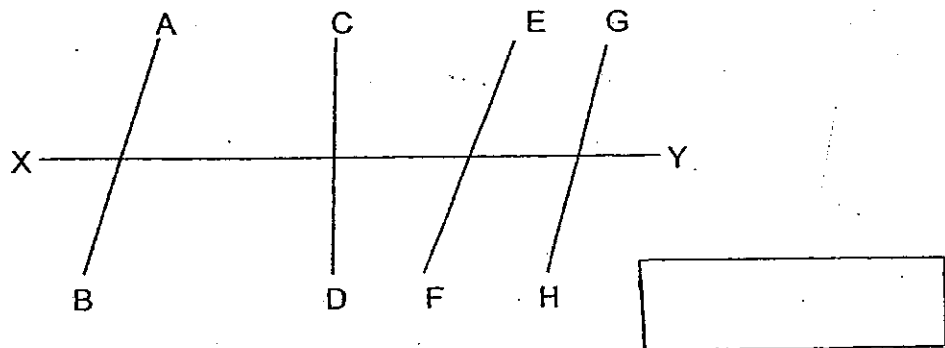

Study the graph carefully and answer questions 33 and 34. The bar graph below shows the number of participants for the four different activities.

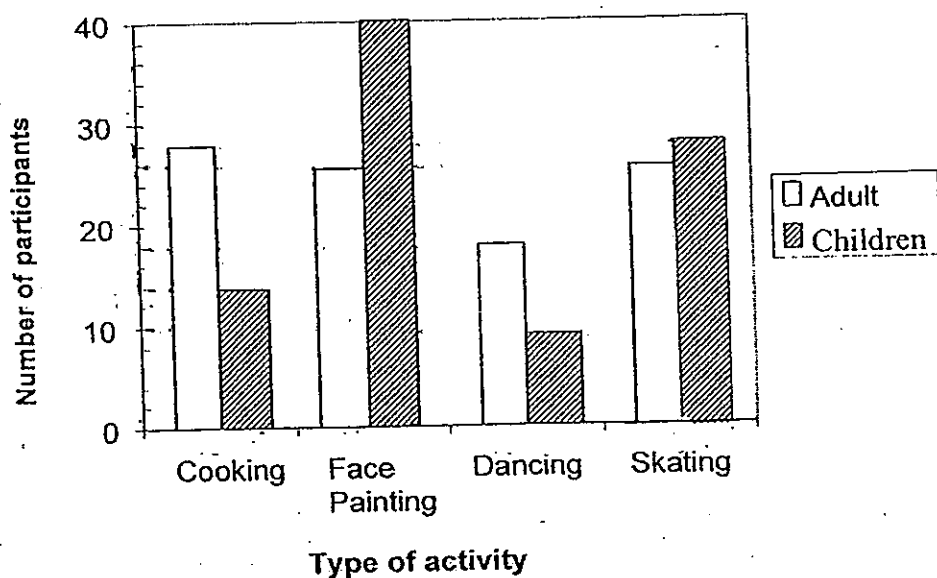

33. Which activity has the least number of participants?

34. How many more children than adults took part in face painting?

35. The sum of 2 numbers is 41. The bigger number is 5 more than the smaller number. What is the bigger number?

36. A box is $\frac{1}{4}$ filled with erasers and $\frac{3}{8}$ filled with sharpeners.

What is the fraction of space left in the box?

37. Emmanuel arranged his toy cars in rows of 8 each.
There were 5 rows and 2 cars left over.
How many cars did Emmanuel have?

- 38 Mrs Ho is 44 years old this year. Two years ago, her son was $\frac{1}{3}$ her age. How old is the son now?

39. David poured away $\frac{2}{5}$ of ^{the} water in a container. There is 18 l of water left in the container. How many litres of water did he pour away?

 l

40. Martin has a collection of gem stones.

He gave away $\frac{1}{9}$ of his collection and sold $\frac{7}{9}$ of it.

He is left with 52 gem stones.

How many gem stones did he have at first?

Section C (20 marks)

For questions 41 to 45, show your working clearly in the space below each question and write your answers in the blanks provided. The marks for each question or part question are given in the brackets.

41. There are 392 fish in the tank. $\frac{2}{7}$ of them are guppies and the rest are goldfish.

- a) What fraction of the fish is goldfish?
- b) How many more goldfish than guppies are there?

Answer: a) _____ (1 m)

b) _____ (3 m)

42. Annie baked some curry puffs. She packed the curry puffs into boxes. Each box had 6 curry puffs. After packing them, she found that she had 22 boxes and 4 curry puffs left.

- a) How many curry puffs were there in total?
- b) If she repacks the curry puffs equally into 8 curry puffs per box, how many boxes will she have?

Answer: (a) _____ (2 m)

(b) _____ (2 m)

43. 240 people went to the school field to support our Rosyth soccer team in a match. 28 of them were teachers while the rest were students.
- a) How many students were there?
 - b) If there were 44 more male students than female students, how many male students were there?

Answer: a) _____ (1 m)

b) _____ (3 m)

44. Elaine bought some notebooks and pens. Each pen costs \$2 more than a notebook. If she paid \$8 for 2 pens and 2 notebooks, how much did she pay for 10 pens?

Answer: _____ (4 m)

45. Nadia read $\frac{1}{4}$ of a book. If she had read another 147 pages, she would have read $\frac{2}{3}$ of the whole book altogether. How many pages were there in the book?

Answer: _____ (4 m)

~END OF PAPER~

Have you checked your work thoroughly?

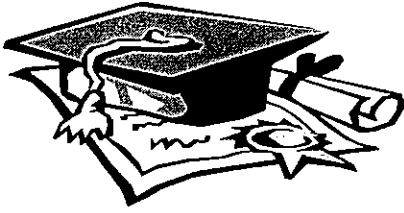

ANSWER SHEET

EXAM PAPER 2010

SCHOOL : ROSYTH PRIMARY
SUBJECT : PRIMARY 4 MATHEMATICS

TERM : SA1

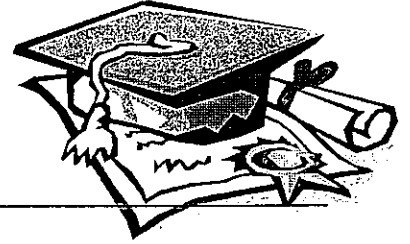

Q1	Q2	Q3	Q4	Q5	Q6	Q7	Q8	Q9	Q10	Q11	Q12	Q13	Q14	Q15	Q16	Q17
3	4	2	3	4	1	3	2	4	4	3	3	1	4	1	2	2

Q18	Q19	Q20
2	2	1

21) 12

22) 9605

23) 900

24) 215

25) $2\frac{5}{6}$

26) 8

27) 7

28) $\frac{1}{4}$, $\frac{1}{3}$, $\frac{1}{2}$, $1\frac{1}{6}$

29) $4\frac{4}{5}$

30)

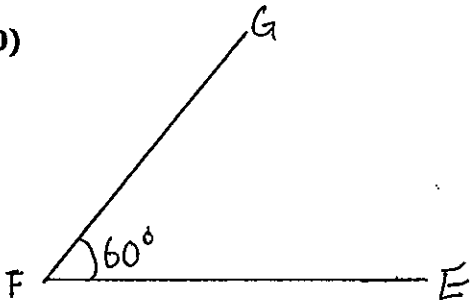

31)

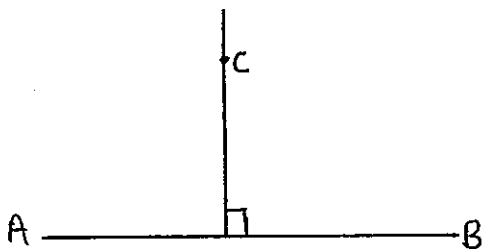

32) GH // AB

33) Dancing

34) 14

35) 23

36) $\frac{3}{8}$

37) 42

38) 16

39) 12

40) 468

<p>41a) $1 - \frac{2}{7} = \underline{\frac{5}{7}}$</p> <p>41b) $7u \rightarrow 392$ $1u \rightarrow 56$ $3u \rightarrow \underline{168}$</p>	<p>42a) $22 \times 6 = 132$ $132 + 4 = \underline{136}$</p> <p>42b) $136 \div 8 = \underline{17}$</p>
<p>43a) $240 - 28 = \underline{212}$</p> <p>43b) $212 - 44 = 168$ $168 \div 2 = 84$ $84 + 44 = \underline{128}$</p>	<p>44) $\\$2 + \\$2 = \\$4$ $\\$8 - \\$4 = \\$4$ $\\$4 \div 4 = \\1 $\\$1 + \\$2 = \\$3$ $\\$3 \times 10 = \underline{\\$30}$</p>
<p>45) $\frac{5}{6} - \frac{1}{4} = \frac{10}{12} - \frac{3}{12}$ $= \frac{7}{12}$</p> <p>$7u \rightarrow 147$ $1u \rightarrow 21$ $12u \rightarrow \underline{252}$</p>	