



AI TONG SCHOOL

2007

SEMESTRAL ASSESSMENT 2

PRIMARY 4

MATHEMATICS

DURATION : 1 h 45 min

DATE : 25 OCT 2007

INSTRUCTIONS

Do not open the booklet until you are told to do so.

Follow all instructions.

Answer all questions.

Name : _____ ()

Class : Primary 4 _____

Marks:

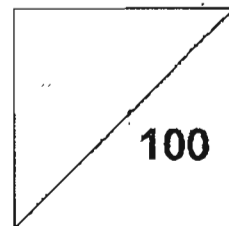

Parent's Signature	:	_____
Date	:	_____

Section A

Questions 1 to 10 carry 1 mark each. Questions 11 to 15 carry 2 marks each.

For each question, four options are given. One of them is the correct answer.

Make your choice (1, 2, 3 or 4)

Shade the oval (1, 2, 3 or 4) on the Optical Answer Sheet with a 2B pencil. (20 marks)

1. $24\ 756 = 20\ 000 + 4000 + \boxed{} + 50 + 6$

What is the missing number in the box?

- (1) 7
- (2) 70
- (3) 700
- (4) 7000

2. The common factor of 48 and 64 is _____.

- (1) 6
- (2) 8
- (3) 12
- (4) 24

3. What fraction of the figure is shaded?

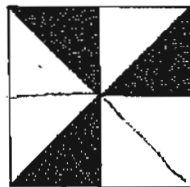

- (1) $\frac{3}{4}$
- (2) $\frac{3}{5}$
- (3) $\frac{3}{7}$
- (4) $\frac{3}{8}$

14. Miss Chan bought some pies. $\frac{2}{5}$ of them were chicken pies. The remaining 60 were fruit pies. How many pies did she buy altogether?
- (1) 20
 - (2) 40
 - (3) 80
 - (4) 100
15. A bus left Singapore at 10 15 and reached Kuala Lumpur at 18 00 on the same day. How long was the journey in hours and minutes?
- (1) 4 h 15 min
 - (2) 7 h 15 min
 - (3) 7 h 45 min
 - (4) 7 h 55 min

Section B

Questions 16 to 35 carry 2 marks each. Write your answers in the spaces provided. For questions which require units, give your answers in the units stated. (40 marks)

16. Complete the number pattern.

3845, 3955, _____, 4175, 4285

Ans: _____

17. Find the value of $6 - 3\frac{4}{9}$.

Ans: _____

18. Find the value of 243×56 .

Ans: _____

19.

5, 6, 8

Using any two numbers in the box above, form the **largest two-digit number** which is a multiple of 4.

Ans: _____

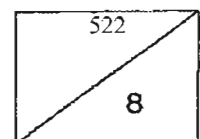

20. Margaret paid \$108 for 6 teddy bears and 4 Barbie dolls.
A teddy bear cost \$3 more than a Barbie doll.
Find the cost of a teddy bear.

Ans: \$ _____

21. The clocks showed the starting and ending time I used to jog this morning. How long did I jog?

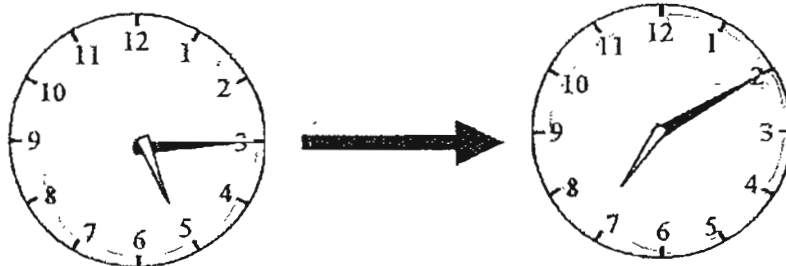

Ans: _____ h _____ min

22. Jason left his house at 15 35. He took 33 minutes to walk to Serangoon Community Club. At what time did he arrive at the community club?

Ans: _____ p.m.

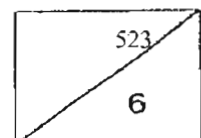

23. Mrs Lim covered $\frac{1}{2}$ of his journey by taxi, $\frac{3}{8}$ by train and the remaining journey by bus. What fraction of her journey was covered by bus?

Ans: _____

24. In the figure below, ABCD is a square. Name 2 lines that are perpendicular to each other

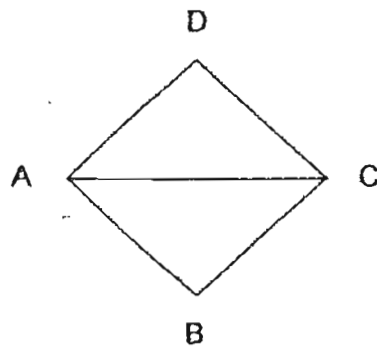

Ans: _____ \perp _____

25. The figure below is not drawn to scale. Find $\angle p$.

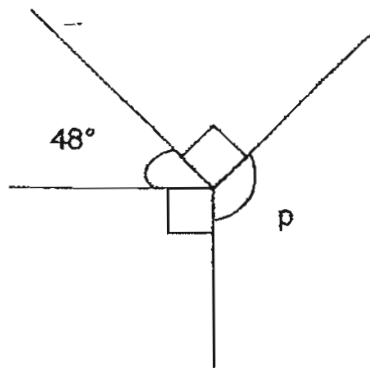

Ans: _____

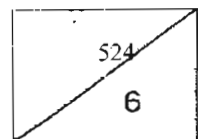

26. A rectangular park measures 60 m by 42 m.
What is the cost of putting up a fence around it if 1 m of fencing costs \$8?

Ans: \$ _____

27. The following figure is not drawn to scale. Find the area of the composite figure.

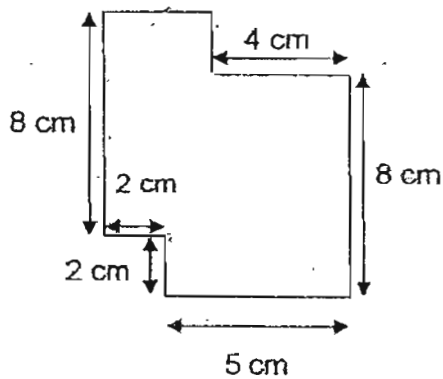

Ans: _____ cm²

28. Shade two more unit squares to make the figure below symmetrical about the line AB.

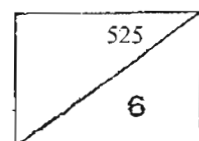
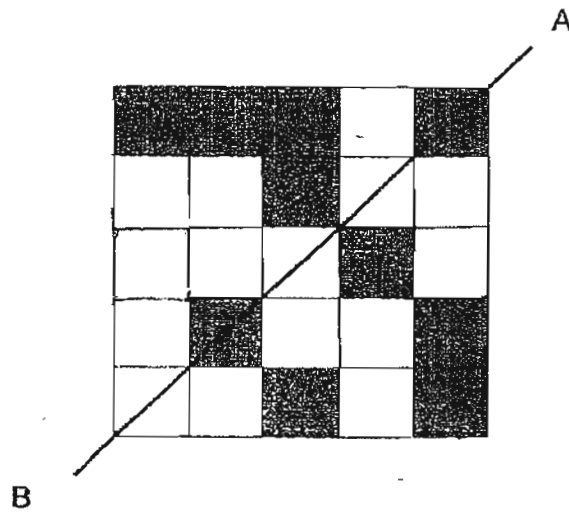

29. The pattern in the box shows part of a tessellation.
Shade the unit shape in the tessellation.

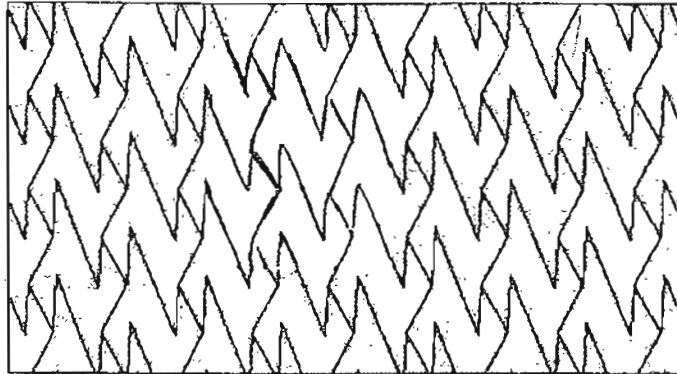

-
30. Mabel cuts a string of 25 m long into 8 equal pieces.
Find the length of each piece. Correct your answer to 2 decimal places.

Ans : _____ m

-
31. A box weighs 5 times as much as a bag. The difference in their mass is 10.4 kg.
What is the mass of the box?

Ans : _____ kg

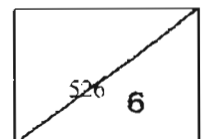

The line graph shows the number of comics sold in a bookshop each year from 2001 to 2005. Use the graph to answer questions 32 and 33.

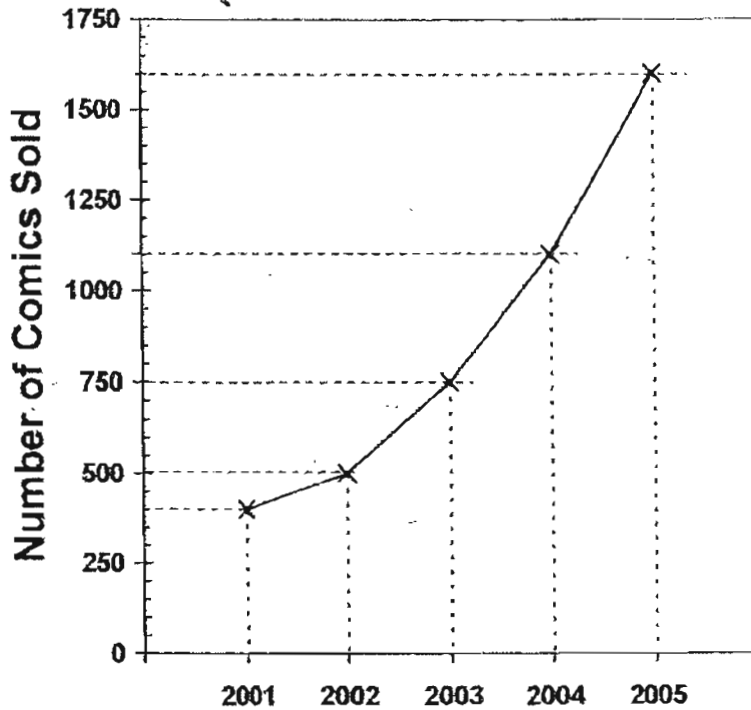

32. What was the difference in number of comics sold between 2001 and 2004?

Ans: _____ comics

33. The greatest increase in the number of comics sold is between which 2 years?

Ans: Between _____ and _____

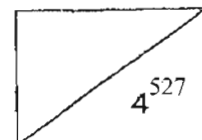

34. A tank is $\frac{5}{8}$ full. It contains 20 litres of water. What is the capacity of the tank?

Ans: _____ l

35. Ben has the same number of 20-cent and 50-cent coins.
Their total value is \$4.90. How many 50-cent coins does he have?

Ans : _____

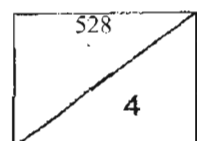

Section C

Questions 36 to 45 carry 4 marks each. Show your working clearly in the space provided below each question and write your answers in the spaces provided.

(40 marks)

36. James bought **8 crates** of peaches. He repacked the peaches into 35 baskets with 64 peaches in each basket and 16 peaches were left over. If each **crate** had an equal number of peaches, how many peaches were there in each crate?

Ans: _____ [4]

37. Ray has 4 times as many picture cards as David. Charles has half of what Ray has. If Ray and David have 245 picture cards altogether, how many picture cards does Charles have?

Ans: _____ [4]

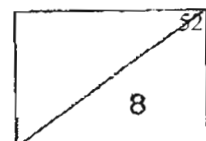

38. In a box, there are yellow, red and green beads.

$\frac{1}{3}$ of the beads in the box are yellow.

There are 30 more red beads than yellow beads.

The rest of the 15 beads are green. How many beads are there altogether?

Ans: _____ [4]

39. Janice spent \$28 on Friday and \$46 on Saturday. She then had $\frac{5}{7}$ of her money left. How much money had Janice at first?

Ans: _____ [4]

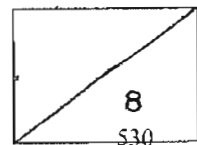

40. The figure below is not drawn to scale. AOC is a straight line.
 $\angle DOB$ is a right angle. Find $\angle x$.

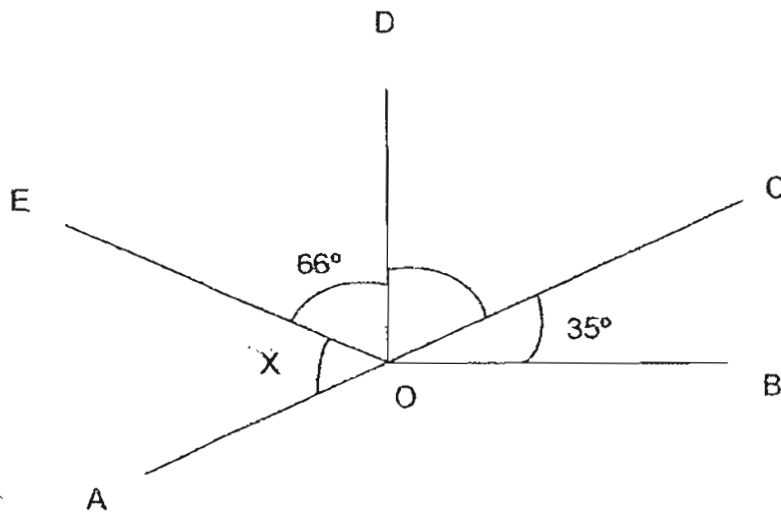

Ans: _____ [4]

41. Gopal bought 2 similar ties and 3 similar belts for \$142.85.
 If each tie cost \$14.80, what was the cost of each belt?

Ans: _____ [4]

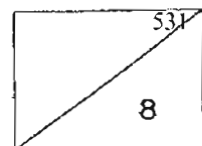

42. Ken packed 3 kg of sugar into a large packet and three small packets. The large packet contained twice as much sugar as each small packet. Find the mass of sugar in the large packet in kg.

Ans : _____ [4]

-
43. Eddie started on his project at 9.30 a.m. He stopped to take a half-hour break at noon for his lunch. He finished his project at 5.15 p.m. How long did he take to do his project?

Ans : _____ [4]

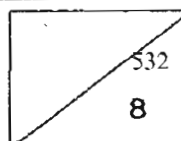

44. A rectangular floor is 9 m long and 8 m wide. A square rug of length 5 m is laid on the floor as shown in the figure below.
- (a) Find the area of the floor **not covered** by the rug.
- (b) Find the cost of carpeting the **uncovered** floor if 1 m² of rug costs \$50.

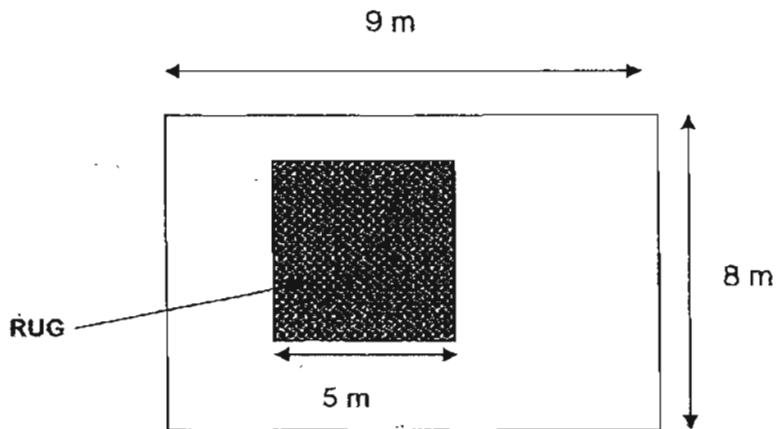

Ans: (a) _____ [3]

(b) _____ [1]

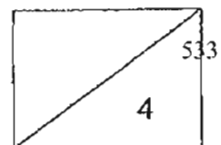

45. Jamil is making patterns using stickers and toothpicks.
 He uses 4 toothpicks to surround a sticker, 6 toothpicks to surround 2 stickers
 and so on. Study the pattern carefully.



(a) Complete the table below.

Number of stickers	Number of toothpicks
1	4
2	6
3	8
4	10
8	<input type="text"/>
10	22
50	<input type="text"/>

[1]

[1]

(b) How many stickers does Jamil need if he uses 162 toothpicks?

Ans: _____ [2]

534

End-of-paper

Please check your work carefully

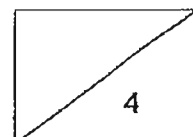

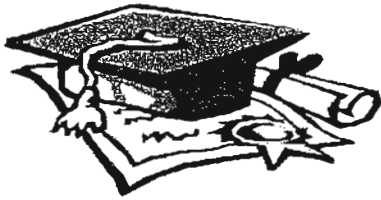

ANSWER SHEET

AI TONG PRIMARY SCHOOL - PRIMARY 4 MATHEMATICS 2007
SEMESTRAL ASSESSMENT (2)

1. 3
2. 2
3. 4
4. 1
5. 3
6. 2
7. 2
8. 4
9. 2
10. 1
11. 3
12. 3
13. 2
14. 4
15. 3
16. 4065
17. 2%
18. 1508
19. 68
20. \$12
21. 1 hr 55 min
22. 4.08pm
23. 1/8
24. $AB \perp BC$
25. 132°
26. 1632
27. 58cm²
- 28.

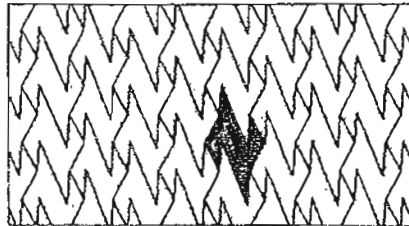

30) 4, 125

31) 13kg

32) 700

33) 2004 and 2005

34) 32

35) 7

36) $35 \times 64 = 2240$

$2240 + 16 = 2256$

$2256 \div 8 = 282$

There were 282 peaches altogether

37) 98

38) 67.5

39) \$259

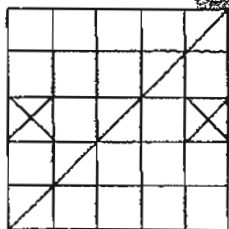

40) $90^\circ - 35^\circ = 55^\circ$

$180^\circ - 55^\circ = 125^\circ$

$125^\circ - 66^\circ = 59^\circ$

$\angle X$ is 59°

41) $\$14.80 \times 2 = \29.60

$\$142.85 - \$29.60 = \$113.25$

$\$113.25 \div 3 = \37.75

The cost of each belt is \$37.75

42) 5 units = 3.0kg

1 unit = $3 \div 5 = 0.6$ kg

2 units = $0.6 \times 2 = 1.2$ kg

43) $7\text{h}15\text{min} - 9\text{h}30\text{min} = 7\text{h}15\text{min}$

$9\text{h}45\text{min} - 30\text{min} = 9\text{h}15\text{min}$

44) a) $9 \times 8 = 72$

$5 \times 5 = 25$

$72 - 25 = 47$

The area of the floor is 47m²

b) $47 \times 50 = \$2350$

The cost of carpeting the uncovered floor is \$2350

45) a) 18, 10

b) $162 - 2 = 160$

$160 \div 2 = 80$

Jamil need 160 stickers.