

METHODIST GIRLS' SCHOOL

Founded in 1887



PRIMARY 4 MID-YEAR YEAR EXAMINATION SCIENCE 2010 BOOKLET A

Total Time : 1 hour 45 minutes

INSTRUCTIONS TO CANDIDATES

Do not open the booklet until you are told to do so.
Follow all instructions carefully.
Answer all questions.

Name: _____ ()

Class: Primary 4. _____

Date: 10 May 2010

Booklet A	/ 60
Booklet B1	/ 20
Booklet B2	/ 20
TOTAL	/ 100

This booklet consists of 19 printed pages.

Section A: (30 x 2 marks)

For each question, four options are given. Choose the most suitable option and shade your answer in the Optical Answer Sheet (OAS) provided.

1. Study the classification chart below.

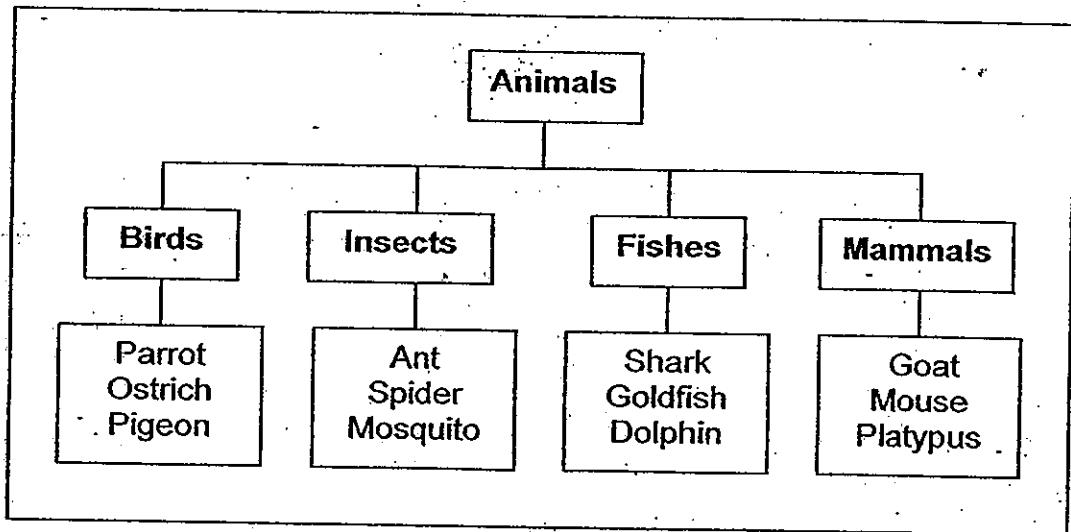

Which of the following animals are **incorrectly** classified?

- (1) Shark and Dolphin
 - (2) Spider and Dolphin
 - (3) Ostrich and Spider
 - (4) Platypus and Dolphin
2. Four children made some statements based on their understanding on plants.

Andrea: Flowers develop from buds.

Katherine: A seed cannot germinate without light.

Lionel: A young plant depends on its seed leaves for food.

Zac: Seeds need water, warmth and carbon dioxide to germinate.

Who made the **correct** statement/s?

- (1) Andrea only
- (2) Andrea and Lionel
- (3) Katherine, Lionel and Zac only
- (4) Andrea, Katherine and Lionel only

3. Norlinah came across a specimen from a field trip in a science lesson. She named it Specimen X and recorded her observations as shown.

Observations

It has a stalk
It has no flowers.
It is not green in colour.
It cannot move from place to place

Based on her observations, which of the following would most likely be Specimen X?

- (1) Moss
 - (2) Cactus
 - (3) Toadstool
 - (4) Bracket Fungus
4. Jason set up the following experiment to carry out an investigation.

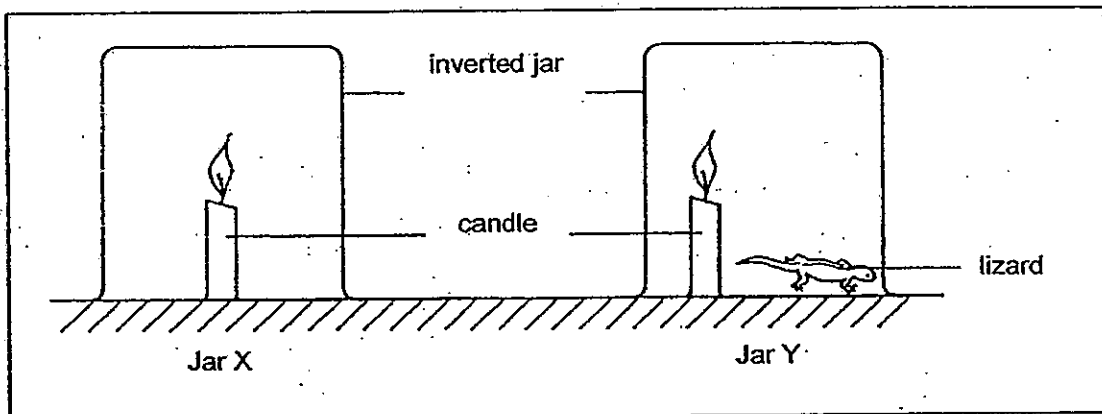

He observed that the candle in Jar Y took a shorter time to be extinguished compared to the candle in Jar X.

What could be the possible conclusion for his experiment?

- (1) Living things respond to changes in the environment.
- (2) Living things absorb heat from the flame of the candle.
- (3) Living things take in oxygen which is required for burning.
- (4) Living things take in carbon dioxide which is required for burning.

5. Study the life cycles shown below.

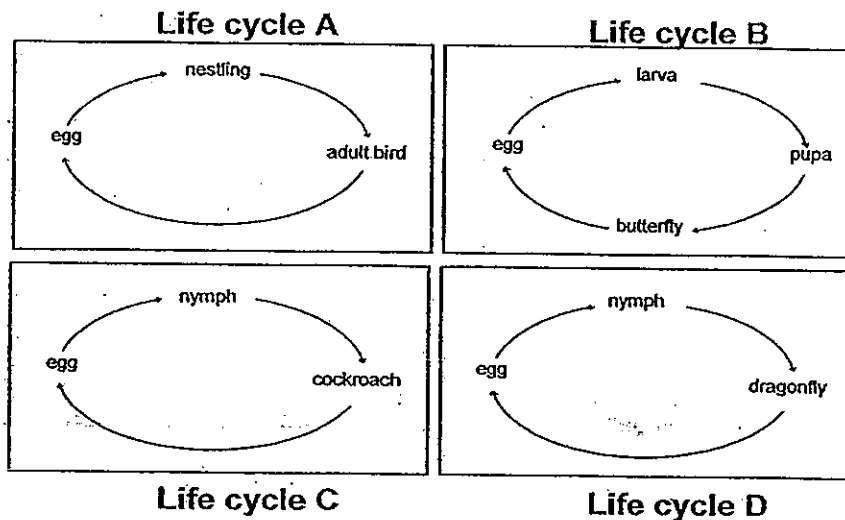

Why is Life cycle D different from the rest?

- (1) It has three stages instead of four.
- (2) The young of the organism in life cycle D grows on land.
- (3) The young of the organism in life cycle D grows in water.
- (4) The young of the organism in life cycle D looks like its adult.

6. The table below shows the stages in the life cycle of a flowering plant which are not in the correct order.

Stage	Development
A	Shoot grows upwards.
B	Seed coat splits open.
C	Roots grow downwards.
D	Flowers appear.
E	Leaves start making food.

Which of the following shows the correct order of the stages?

- (1) B, A, C, E, D
- (2) B, C, A, D, E
- (3) B, C, A, E, D
- (4) C, B, A, E, D

7. Which one of the following graphs below shows the relationship between the mass of the seed leaves and the height of the seedling as it grows?

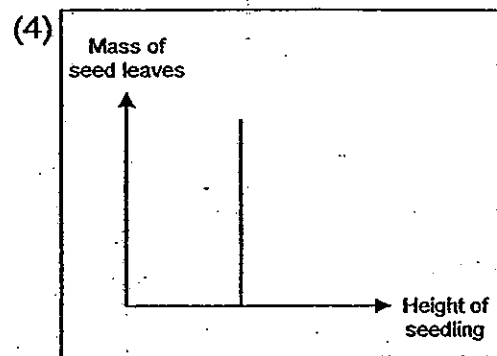
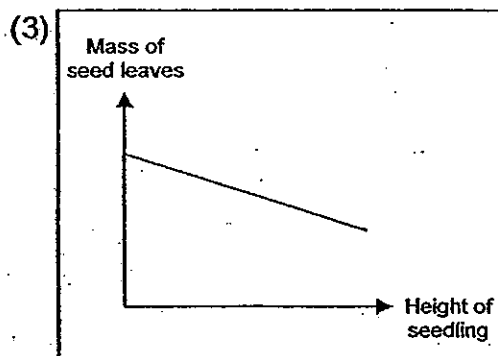
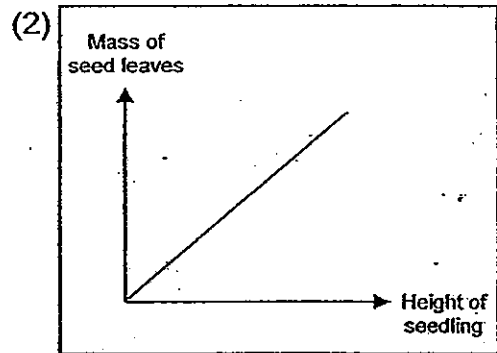
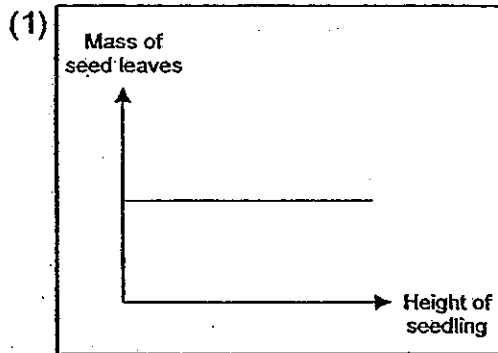

8. Study the classification table below carefully.

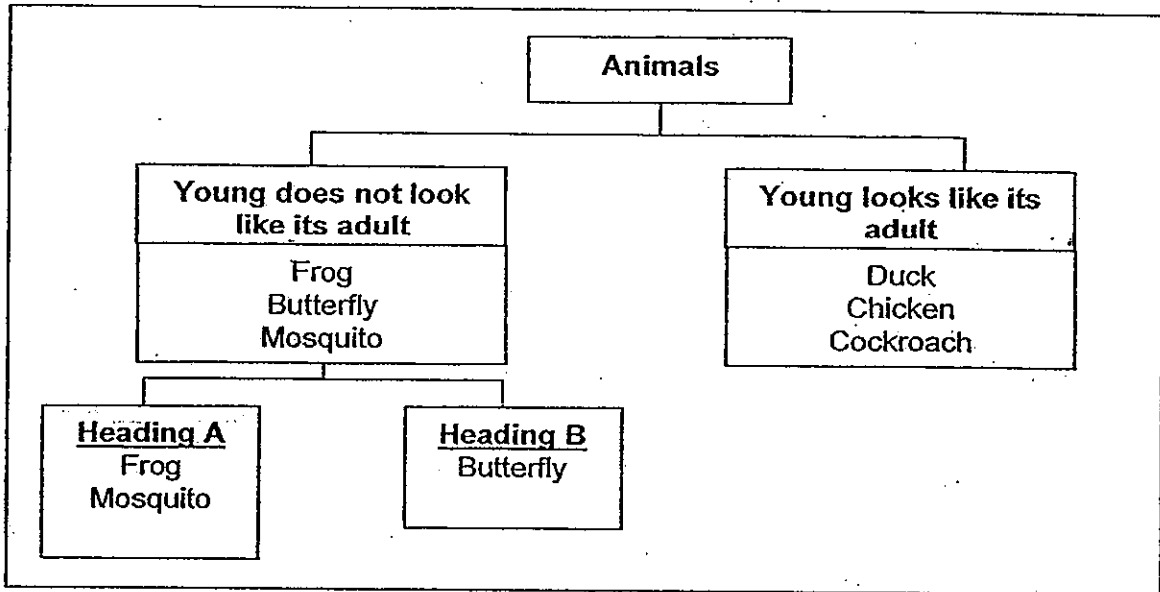

Which one of the following represents Heading A and B?

	Heading A	Heading B
(1)	Give birth to young	Lay eggs
(2)	Eggs are laid in water	Eggs are laid on land
(3)	Moults when young	Does not moult when young
(4)	Has four stages in its life cycle	Has three stages in its life cycle

9. Which one of the following illustrates what happens when we bend our arm?

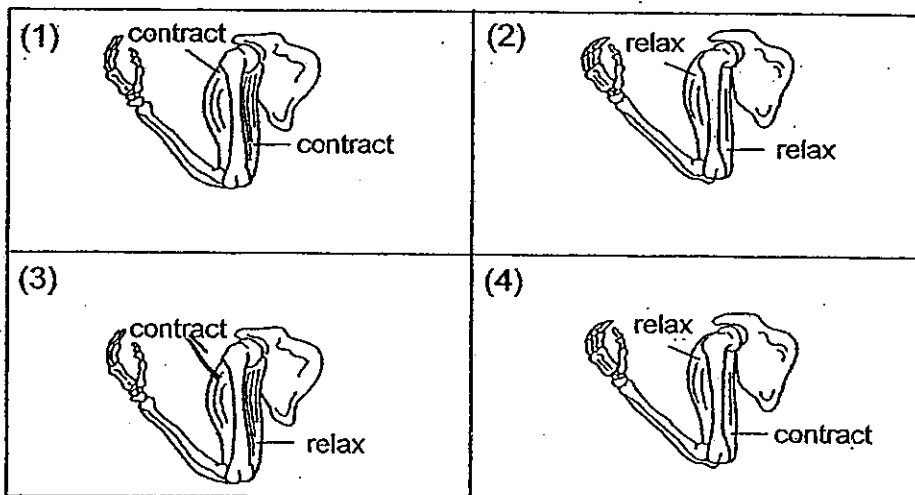

10. Tommy spread a layer of wax on different parts of four similar plants A, B, C and D as stated in the following table. The wax prevents the plants from exchanging gases with the surroundings.

	Plant A	Plant B	Plant C	Plant D
Part of plant where wax is applied	Upper surface of leaves	Stem	Lower surface of leaves	Upper and lower surface of leaves

He watered the plants daily and placed them beside a sunny window. After a week, he noticed that two of the plants wilted first. Which of the following are most likely to be the two plants?

- (1) A and B
- (2) A and C
- (3) A and D
- (4) C and D.

11. The following diagram shows a leaf during the process of making food.

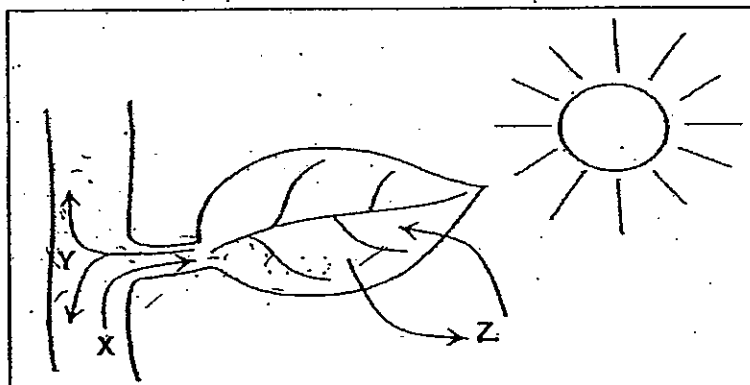

The arrows shown in the diagram represent the movement of substances X, Y and Z during the process of making food.

Which one of the following correctly represents X, Y and Z?

	X	Y	Z
(1)	Water	Food	Gases
(2)	Water	Gases	Food
(3)	Gases	Food	Water
(4)	Food	Water	Gases

12. The graph below shows the amount of carbon dioxide in the air in a small garden. A, B, C and D represents the time over a period of 24 hours.

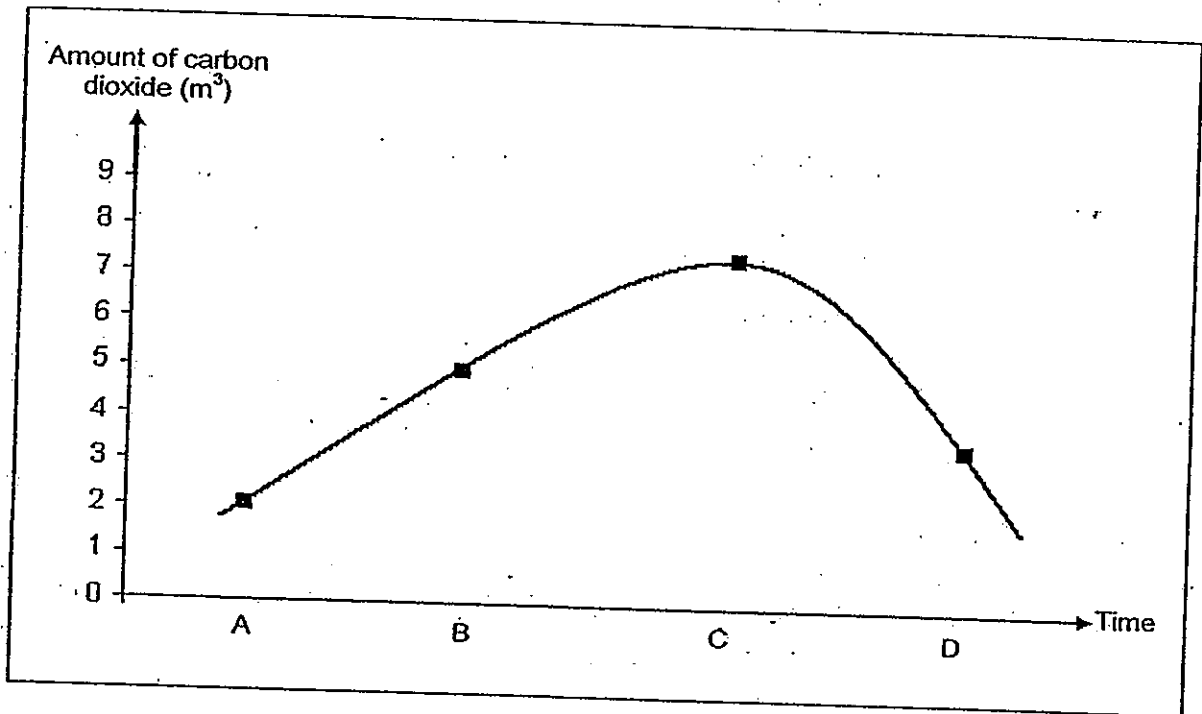

Which one of the following shows the correct time for A, B, C and D?

	A	B	C	D
(1)	6 a.m.	1 p.m.	6 p.m.	1 a.m.
(2)	6 p.m.	1 a.m.	6 a.m.	1 p.m.
(3)	12 noon	7 p.m.	12 midnight	7 a.m.
(4)	12 midnight	7 a.m.	12 noon	7 p.m.

13. Kelly set up the following experiment as shown. She split the stalk of a white carnation into half and immersed one half into blue food colouring and the other half into red food colouring. She labelled half of the petals Part A and the other half Part B. Then, she observed the carnation the next day.

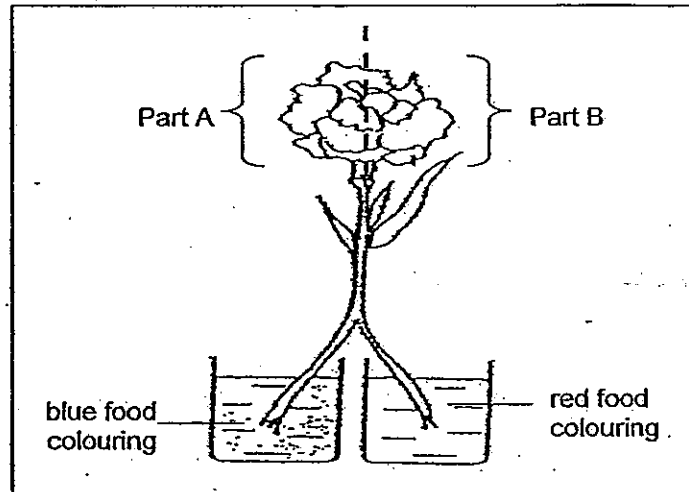

Which of the following observations about Part A and B and its reason is correct?

	Part A	Part B	Reason
(1)	Turns blue	Turns red	The red and blue colourings were transported by the food carrying tubes in the stalk to the petals.
(2)	Turns blue	Turns red	The red and blue colourings were transported by the water carrying tubes in the stalk to the petals.
(3)	Turns purple	Turns purple	The red and blue colouring mixed together to turn purple before it was transported by the water carrying tubes in the stalk to the petals.
(4)	Turns red and blue	Turns red and blue	The red and blue colourings were both transported by the water carrying tubes in the stalk to the petals.

14. Mrs Lim put four glass jars A, B, C and D containing five similar peas in different conditions as shown below. After a few days, she observed the peas.

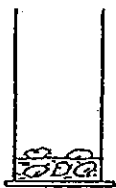
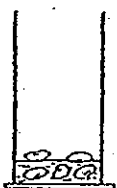
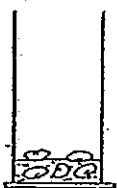
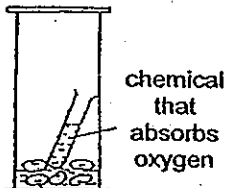
	A	B	C	D
Jar				
Damp/Dry cotton wool	Damp	Dry	Damp	Damp
Location	Placed in refrigerator	Placed near a window	Placed near a window	Placed near a window
Other conditions	-	-	-	Chemical that absorbs oxygen is added

Which jar would she be able to observe seedlings?

- (1) Jar A
- (2) Jar B
- (3) Jar C
- (4) Jar D

15. Which of the following body systems work together to enable us to remove carbon dioxide?

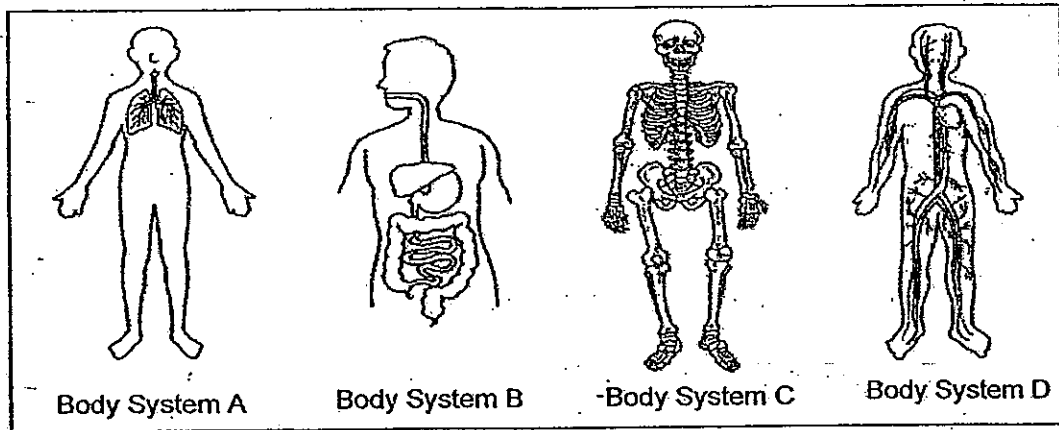

- (1) A and B only
- (2) A and D only
- (3) A, B and D
- (4) All of the above

16. Strings W, X, Y and Z are of the same thickness and length. However, they are made of different materials. The diagram below shows the greatest mass that each string can support before it breaks.

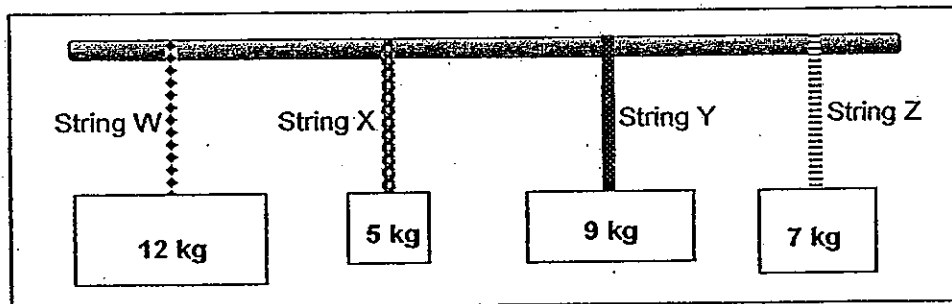

Which string(s) is/are able to support a mass of up to 8 kg without breaking?

- (1) String Y only
- (2) String W only
- (3) String W and Y only
- (4) String W, Y and Z only

17. The diagram below shows an apple and three identical marbles placed on a balance.

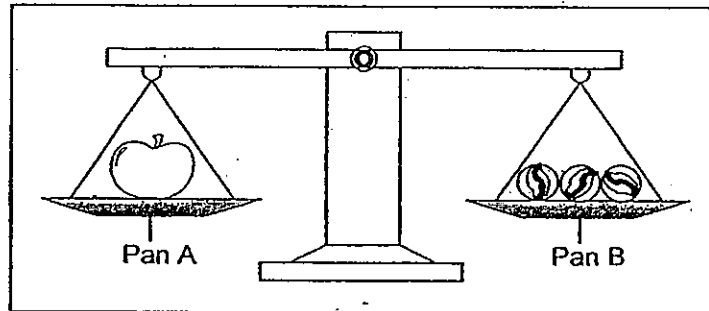

Which one of the following statements is true?

- (1) The apple has a bigger mass than two marbles.
 - (2) When one marble is removed, Pan A will move up.
 - (3) When two marbles are removed, Pan B will move down.
 - (4) The apple has a smaller mass than the three marbles in total.
18. Wendy Jo learnt that an iron nail becomes an electromagnet when placed in a coil of wire combined to batteries.

She wanted to find out whether **the number of turns of the coil affected the strength of the electromagnet**. She set up four arrangements as shown in the diagrams below.

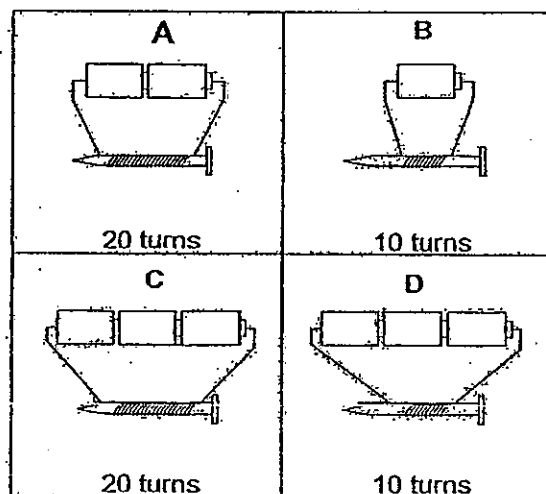

Which two arrangements should she use to make it a fair test?

- (1) A and B
- (2) A and C
- (3) B and C
- (4) C and D

19. A magnet is attached to a retort stand and a paper clip is tied to a wooden block as shown in the diagram below.

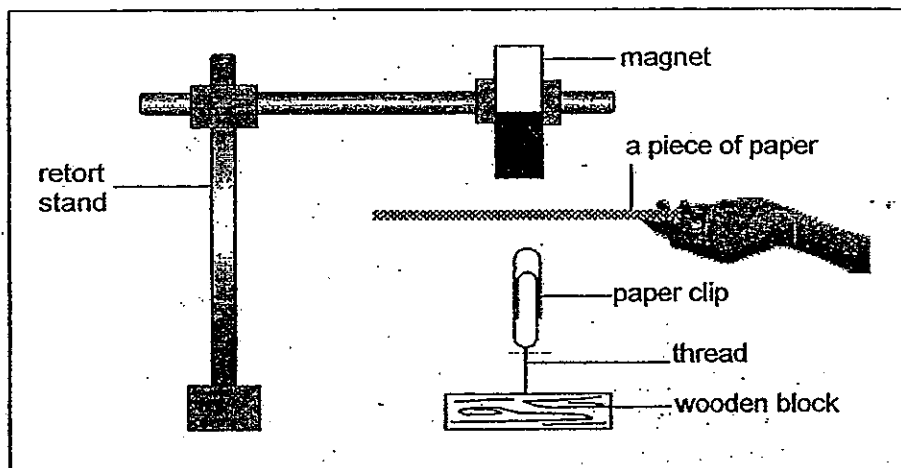

It was observed that the paper clip continues to 'float' when a piece of paper is placed between the magnet and the paper clip. Which of the following sentences below explain the reason/s correctly?

A	The magnetic force from the magnet can pass through the paper.
B	The magnetic force from the magnet cannot pass through the paper.
C	The magnetic force from the magnet can pass through a magnetic material.

- (1) A only
(2) B only
(3) A and B only
(4) A, B and C only

20. Look at the set-up shown below.

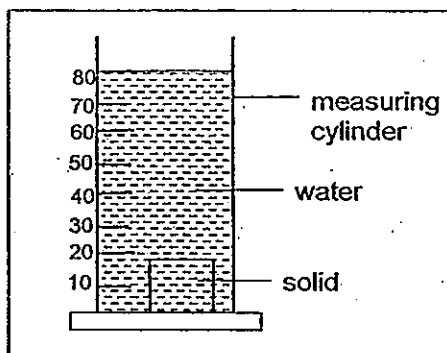





The table below shows some measurements taken during an activity carried out using this set-up.

Volume of water in measuring cylinder (ml)	Volume of water and solid in measuring cylinder (ml)	X
50	80	$80 - 50 = 30$

Which one of the headings below best represents X?

- (1) Mass of solid in the measuring cylinder.
- (2) Mass of water in the measuring cylinder.
- (3) Volume of solid in the measuring cylinder.
- (4) Volume of water in the measuring cylinder.

21. Four children, Ali, Ben, Charlie and David each made a statement on the conditions that are necessary for a shadow to be formed.

<p>The object must be a solid.</p>  <p>Ali</p>	<p>A light source must be present.</p>  <p>Ben</p>	<p>The object must be upright.</p>  <p>Charlie</p>	<p>The object must be able to block light.</p>  <p>David</p>
---	---	---	---

Which of the following children above are correct?

- (1) Ali and Ben
- (2) Ben and David
- (3) Ben and Charlie
- (4) Charlie and David

22. A wooden pole is placed in the centre of a square board. Four similar bulbs, A, B, C and D, are placed at each corner of the board as shown in the diagram below.

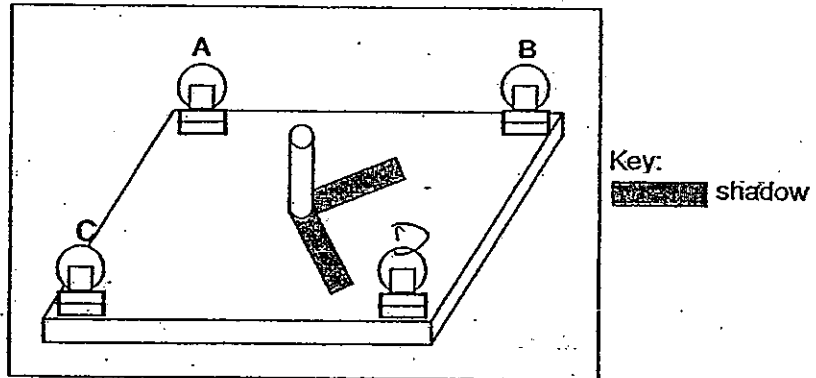

Which of the bulbs have to be switched on such that the shadows of the wooden pole are shown in the diagram above?

- (1) A and B
 (2) A and C
 (3) B and D
 (4) C and D
23. On a dark night, Matilda walked along a street, from Point A to Point D as shown in the diagram below. There was a lighted street lamp along the path of her route.

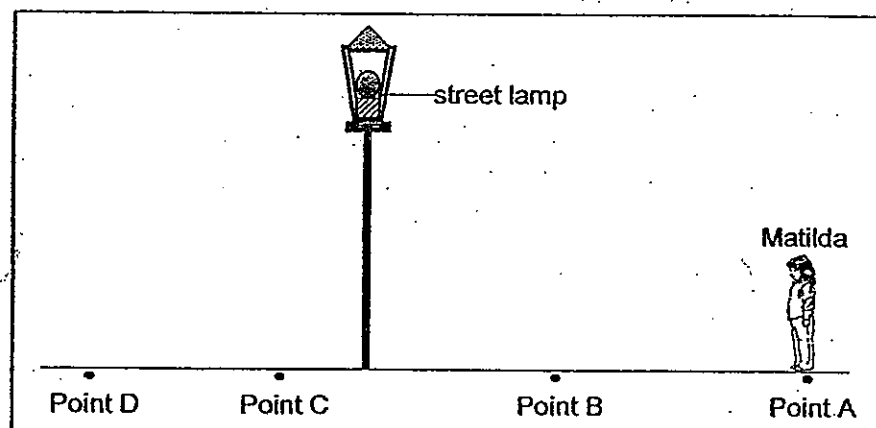

At which point, A, B, C or D, would Matilda's shadow be the longest?

- (1) A
 (2) B
 (3) C
 (4) D

Refer to the diagram below to answer questions 24 and 25.

Ariel, Bernice and Clara were trying to look through three different tubes, A, B and C, to see what was in the sealed box as shown in the diagram below. A small hole was created at the top of the box to allow light to enter.

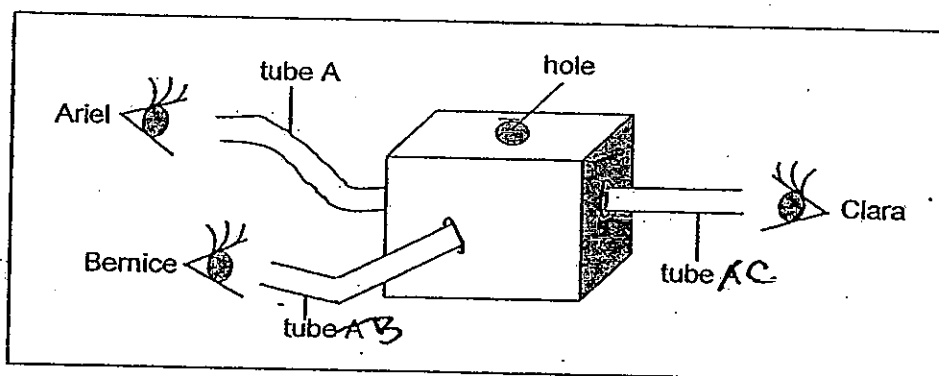

24. Who would be able to see what was inside the box?
- (1) Ariel only
 - (2) Bernice only
 - (3) Clara only
 - (4) Ariel, Bernice and Clara
25. Which one of the following properties of light, explains correctly the reason for your answer above?
- (1) Light travels in curved lines.
 - (2) Light travels in a straight line.
 - (3) Light cannot pass through opaque object.
 - (4) Light can pass through transparent object.

26. The word, "Shadow" was scribbled on a piece of cardboard as shown in the diagram below.

Shadow

A mirror was then placed in front of the cardboard as shown below.

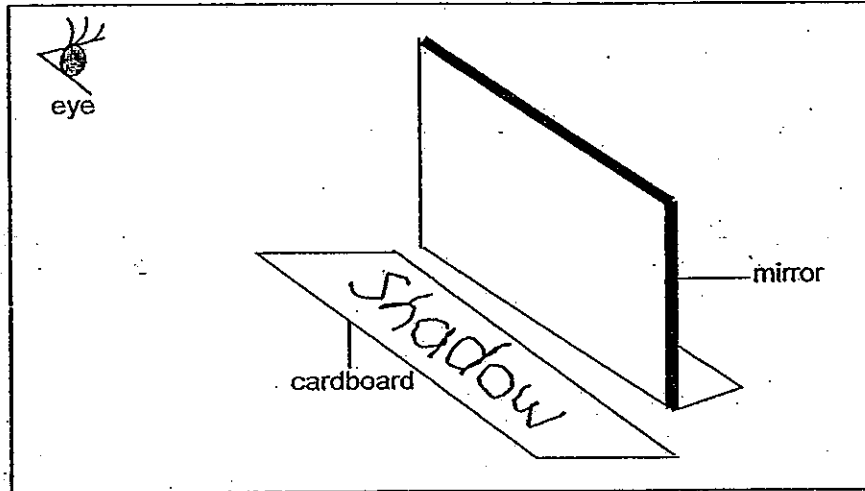

Which one of the following images would you see in the mirror?

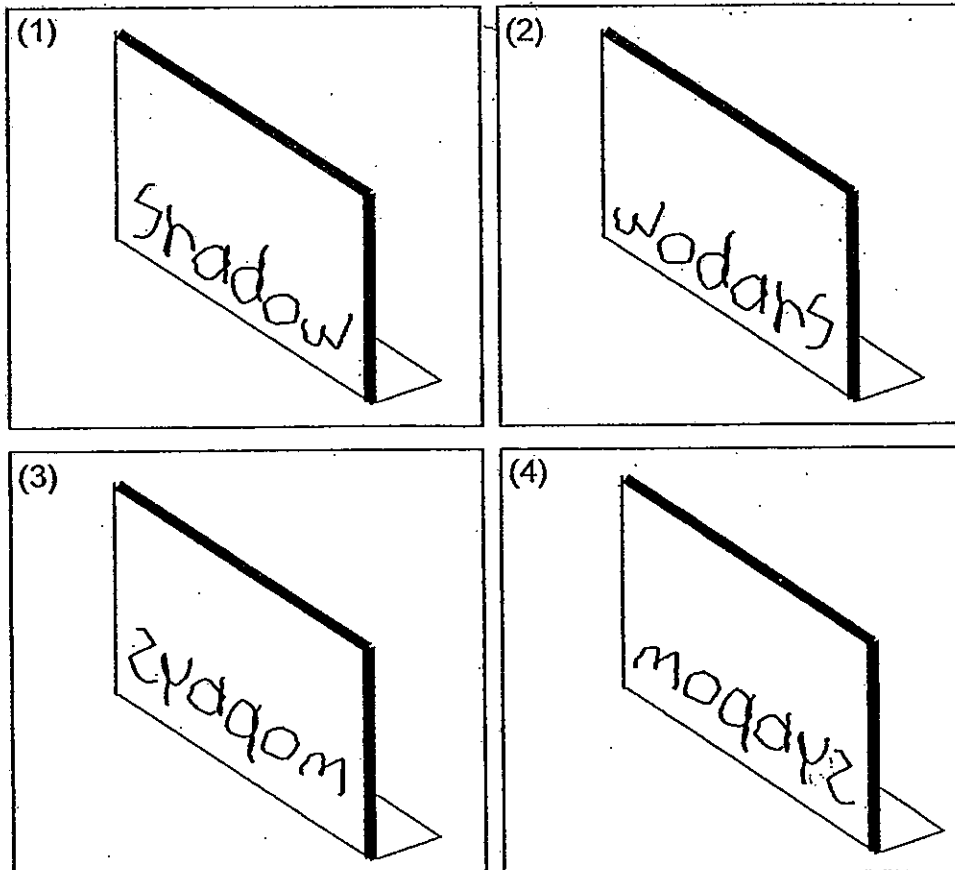

27. The table below shows the lengths of the shadow of a 10 cm stick measured at different times in a day.

Time	Length of shadow (cm)
6 a.m.	15
8 a.m.	10
10 a.m.	6
12 noon	?
2 p.m.	5
4 p.m.	9
6 p.m.	13

Based on the information above, which one of the following line graph **best represents** the lengths of the shadow of a 1-metre stick measured at different times of a day?

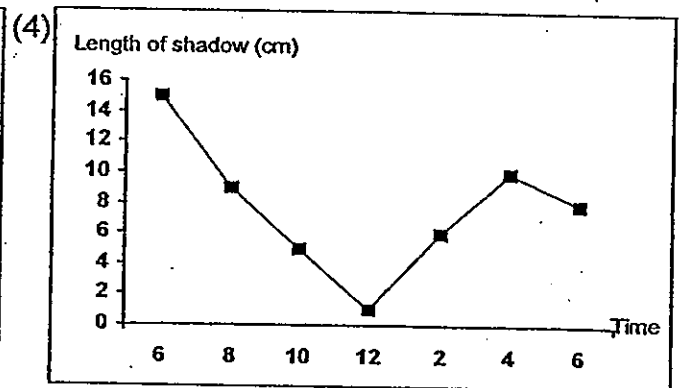
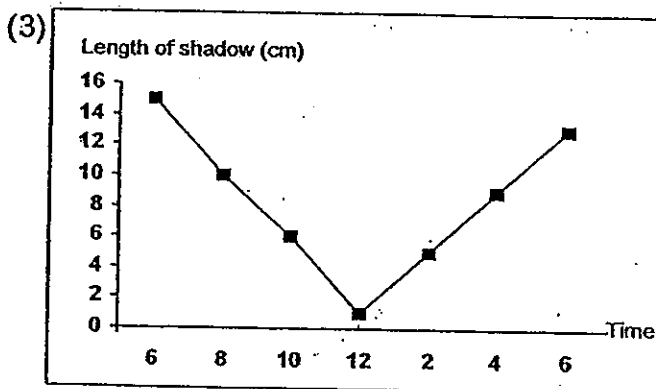
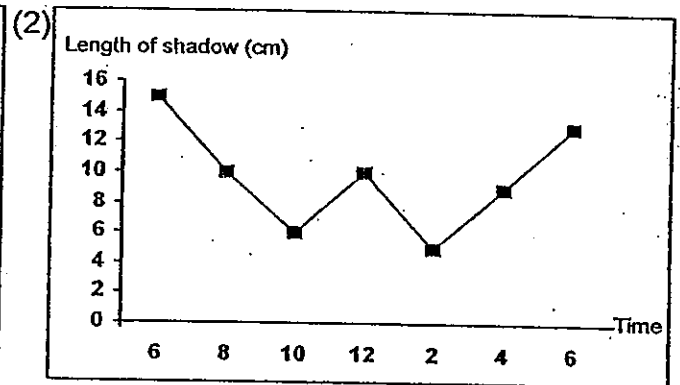
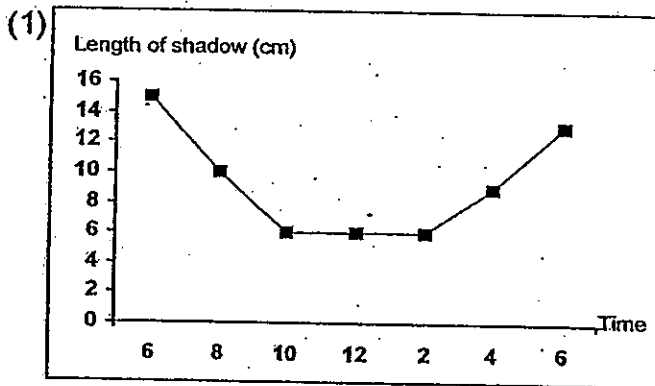

28. Matilda attached a light sensor to a datalogger and measured the amount of light that passed through material X in a dark room as shown in the diagram below.

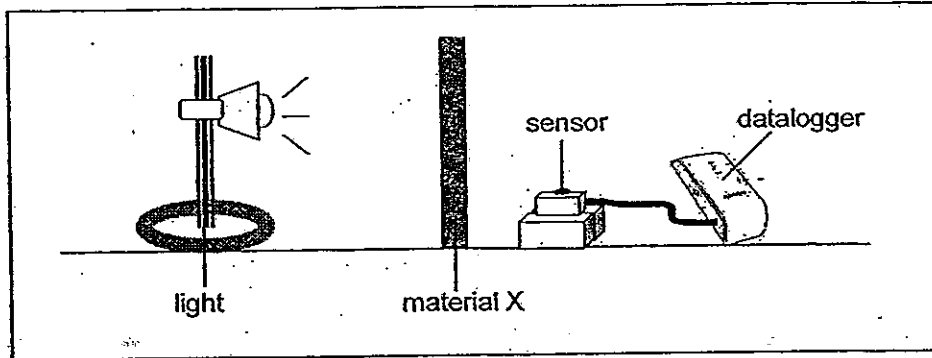

She repeated the activity using material Y, followed by material Z. She recorded the readings as shown in the table below.

	Material X	Material Y	Material Z
Amount of light passed through (lux)	340	870	0

Which one of the following best represents material X, Y and Z correctly?

	Material X	Material Y	Material Z
(1)	Frosted plastic	Clear glass	Cardboard
(2)	Clear glass	Frosted plastic	Cardboard
(3)	Cardboard	Clear glass	Frosted plastic
(4)	Cardboard	Frosted plastic	Frosted plastic

clear glass

29. Susan set up the experiment below using two similar syringes.

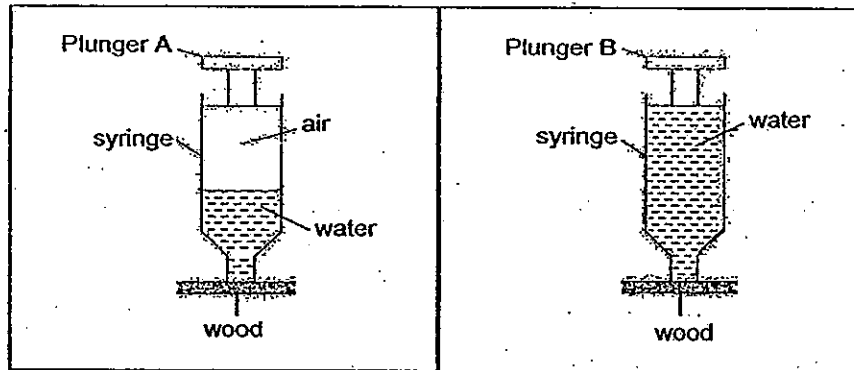

Which one of the following statements is correct?

- (1) Plunger A would move downwards when Susan applied force on it.
- (2) Plunger B would move downwards when Susan applied force on it.
- (3) Both Plunger A and B would be pushed in when Susan applied force on it.
- (4) Both Plunger A and B would not be pushed in when Susan applied force on it.

30. In the set-up below, Beaker Q contains water. Beaker R contains water that had been left in the freezer overnight.

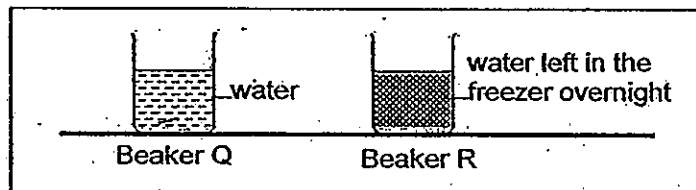

Which of the following diagrams below can represent Beaker Q and R when each of them is tilted at an angle?

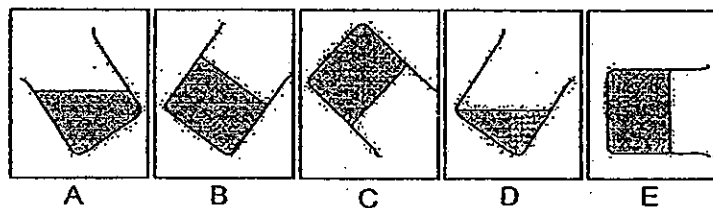

	Beaker Q	Beaker R
(1)	A, D	B, C, E
(2)	B, C, E	A, D
(3)	C, E	A, B, D
(4)	B, C	A, D, E

METHODIST GIRLS' SCHOOL

Founded in 1887



PRIMARY 4 MID-YEAR YEAR EXAMINATION SCIENCE 2010 BOOKLET B1

Total Time : 1 hour 45 minutes

INSTRUCTIONS TO CANDIDATES

Do not open the booklet until you are told to do so.
Follow all instructions carefully.
Answer all questions.

Name: _____ ()

Class: Primary 4. _____

Date: 10 May 2010

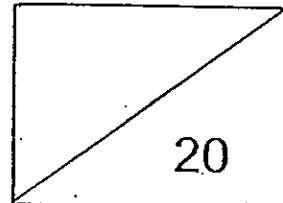

This booklet consists of 8 printed pages.

Section B1 : (20 marks)

Write the answers in the blanks provided.

31. Study the flow chart below.

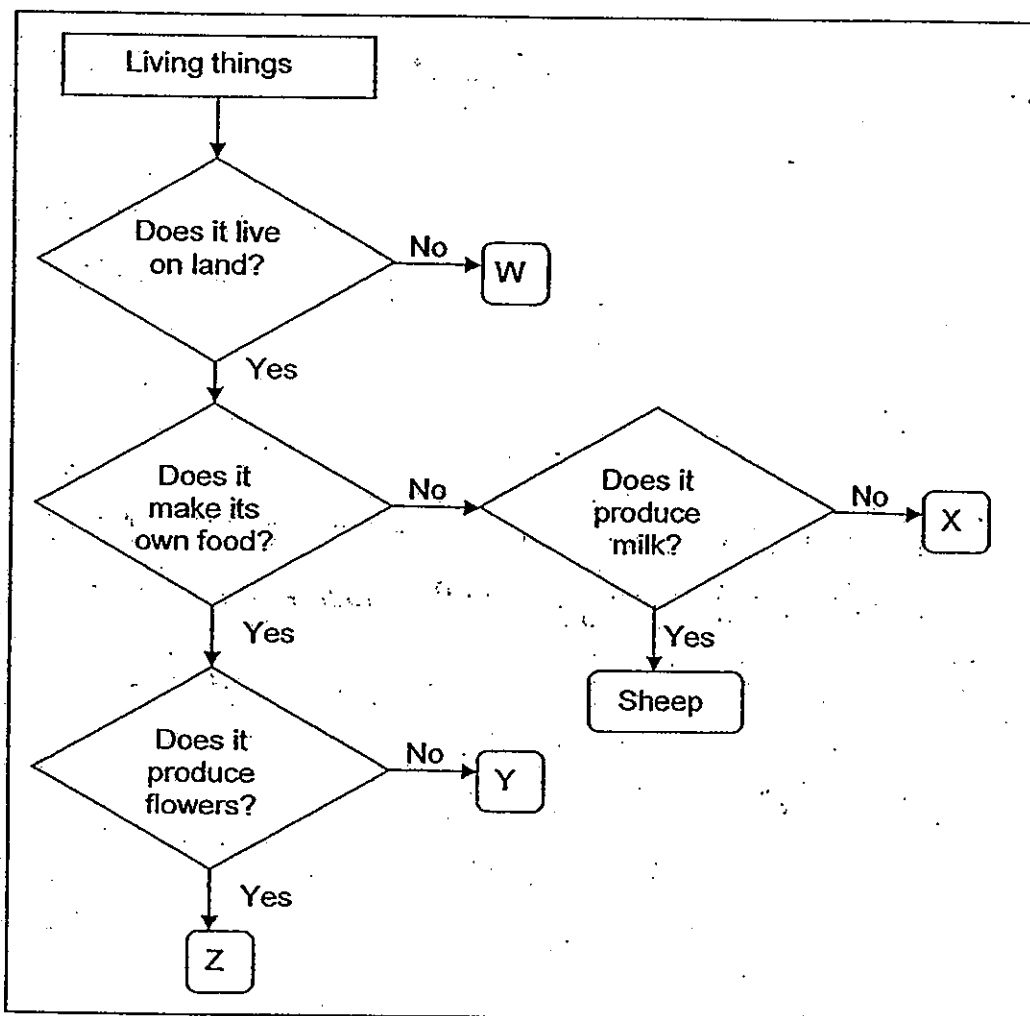

a) Which of the following organisms W, X, Y or Z could be an eel? (1m)

b) Based on the flow chart, give supporting reasons why organism X is an animal but not a mammal. (1m)

32. Edmund wanted to transfer a plant from his garden into a pot. The diagram below shows how he did the transfer.

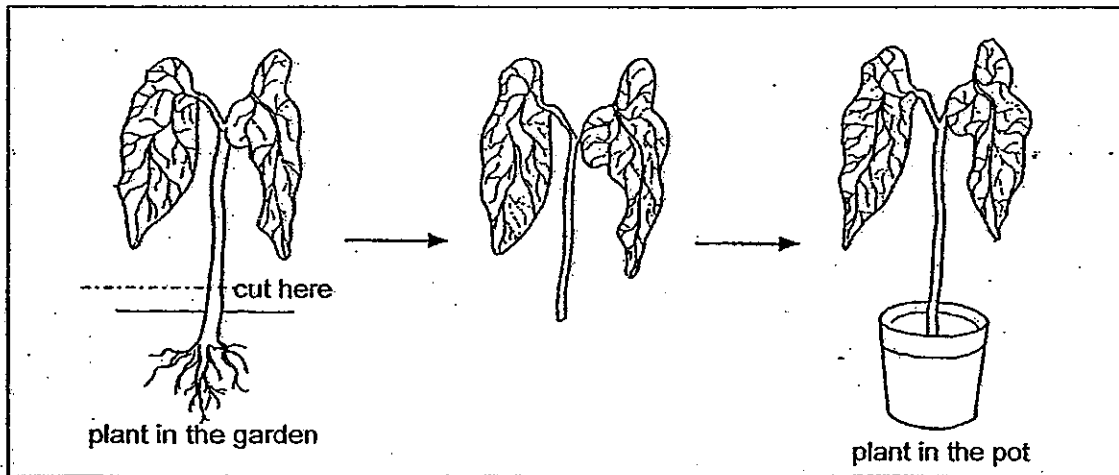

Next day, there was a thunderstorm and the plant in the pot fell over.

- (a) When the plant was first planted in the garden, it was able to withstand the strong wind from the thunderstorm. Why was it unable to do so when it was transferred to the pot? (1m)

- (b) What should Edmund have done to ensure that the plant will be able to withstand the strong wind in the future? (1m)

33. Study the following plants. The cactus is a plant found in the desert and the teak tree is found in a rainforest.

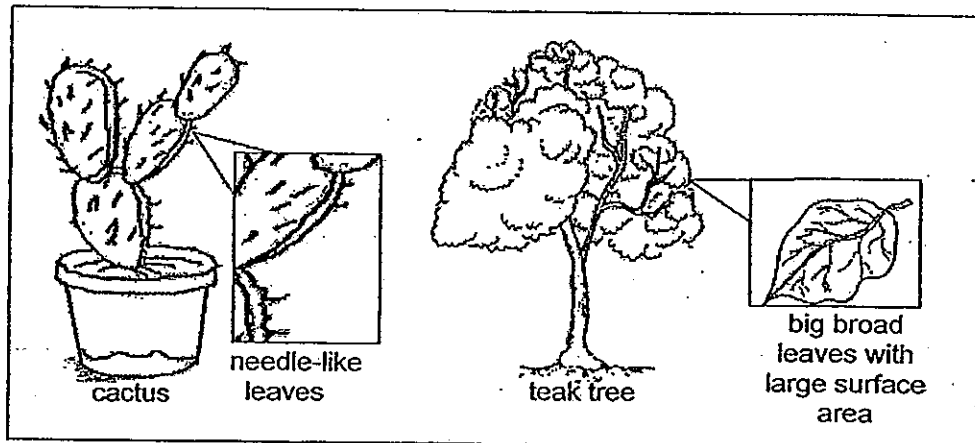

- (a) How does the large surface area of the leaf of the teak tree enable it to make food more efficiently? (1m)

- (b) Since the leaves of a plant help it to make food, why do the leaves of the cactus plant appear small and needle-like? (1m)

34. Ahmad collected some leaves from different trees and classified them according to the table below.

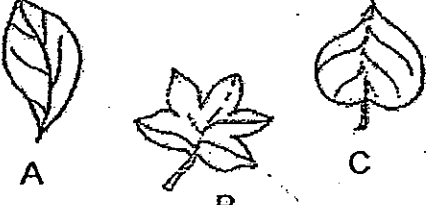
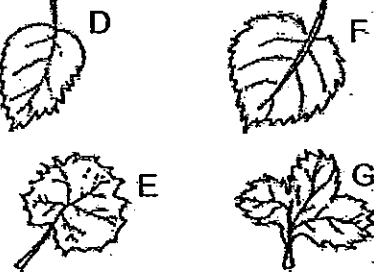
Group A	Group B
	

- (a) Give suitable headings for Group A and B. (2m)

Group A : _____

Group B : _____

- (b) Ahmad then regrouped the leaves into pairs. Complete the table below by identifying another pair of leaves and state the common characteristic between them. An example has been done for you. **(Do not compare vein patterns)** (2m)

Pair of leaves	Common characteristic
C and F	Heart-shaped

35. The diagram below shows the human skeletal system.

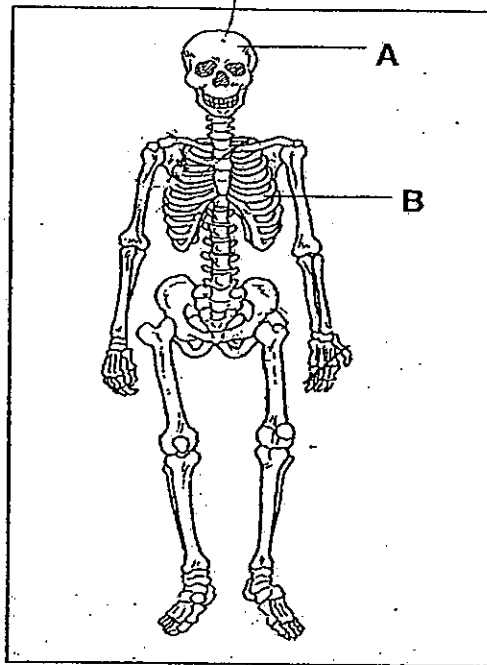

(a) Identify and circle any two joints in the diagram above. (1m)

(b) Why are joints important in the human skeletal system? (1m)

(c) State one similarity between the function of the bones labelled "A" and "B". (1m)

(d) Name another system that works with the skeletal system to allow movement. (1m)

36. Study the following table.

Characteristics	Animal X	Animal Y
Warm-blooded	x	√
Have hair	x	√
Usually lay eggs in water	√	x
Breathe using lungs	x	√

- (a) Based on the characteristics given above, name the group of animals in which Animal X and Y belong to. (2m)

Animal X : _____

Animal Y : _____

- (b) The following diagram shows the life cycle of a Mayfly. The Mayfly nymph eats a lot and moults many times before becoming an adult.

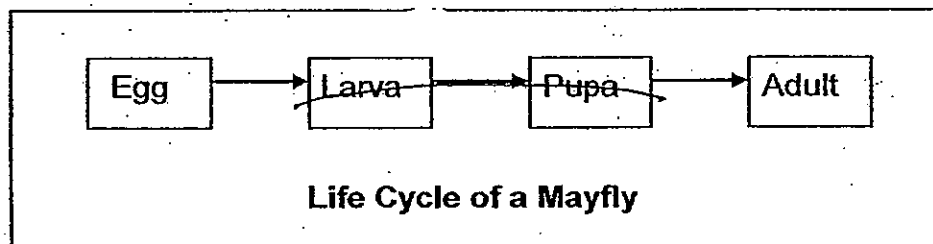

- (i) Why is it necessary for the mayfly nymph to moult? (1m)

37. Mr Tan wanted to find out which type of food cockroaches are attracted to. He put four different types of food at four different corners of a rectangular cardboard. Then, he placed 20 cockroaches in the centre of the dish in the area marked A.

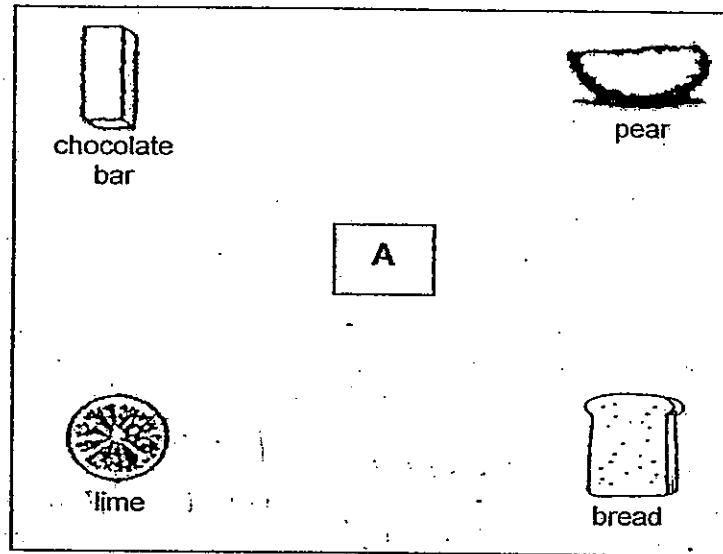

After 2 hours, he counted the number of cockroaches found at each type of food and recorded the information in a table as shown below.

Type of food	Number of cockroaches
Pear	2
Lime	1
Bread	9
Chocolate Bar	8

- (a) Why did Mr Tan put the cockroaches at A for the experiment? (1m)

- (b) Based on the information recorded in the table, plot a bar chart to show the number of cockroaches found at each of the different food items. (2 m)

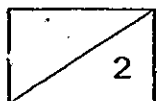
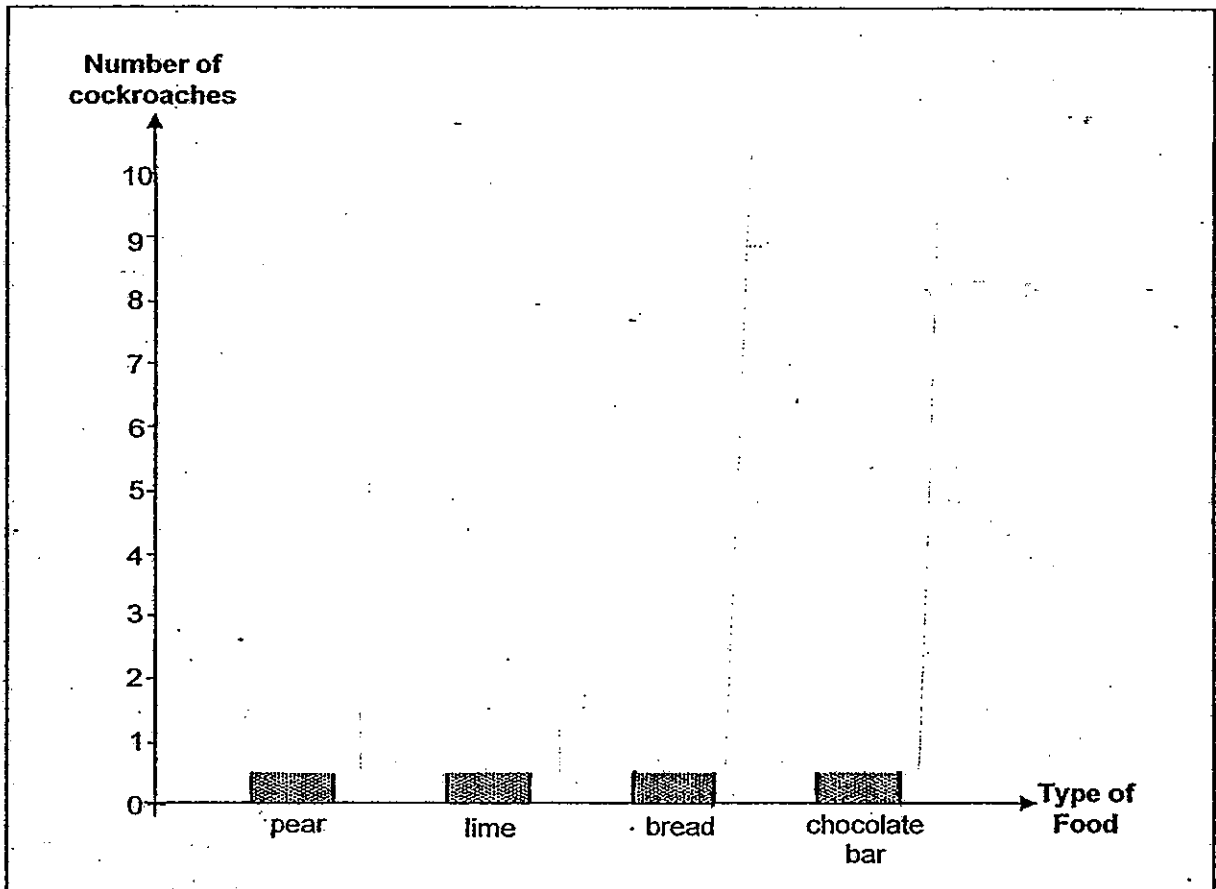

METHODIST GIRLS' SCHOOL

Founded in 1887



PRIMARY 4 MID-YEAR EXAMINATION SCIENCE 2010 BOOKLET B2

Total Time : 1 hour 45 minutes

INSTRUCTIONS TO CANDIDATES

Do not open the booklet until you are told to do so.
Follow all instructions carefully.
Answer all questions.

Name: _____ ()

Class: Primary 4. _____

Date: 10 May 2010

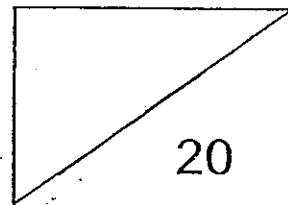

This booklet consists of 8 printed pages.

Section B2 : (20 marks)

Write the answers in the blanks provided.

38. Sandra carried out an experiment using four different materials, A, B, C and D, of equal lengths. She then placed one corner of each material into some coloured water as shown in the diagram below.

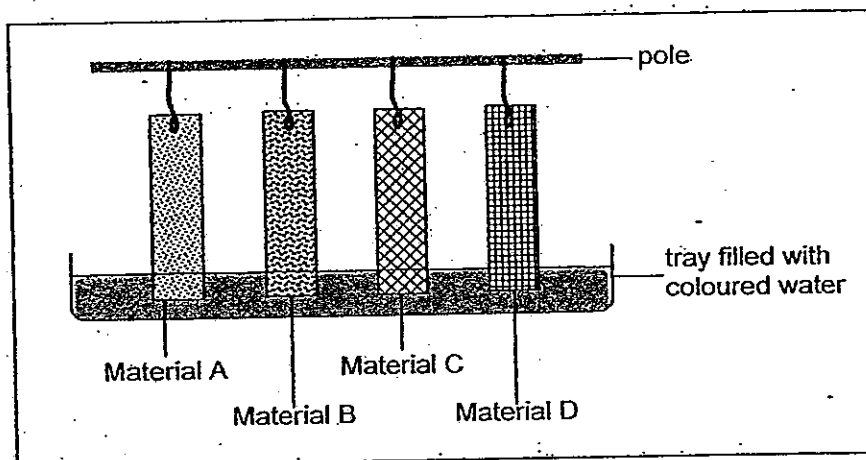

Ten minutes later, she removed the coloured water. Then she measured the length of each strip of material that was stained by the coloured water as shown in the diagram below.

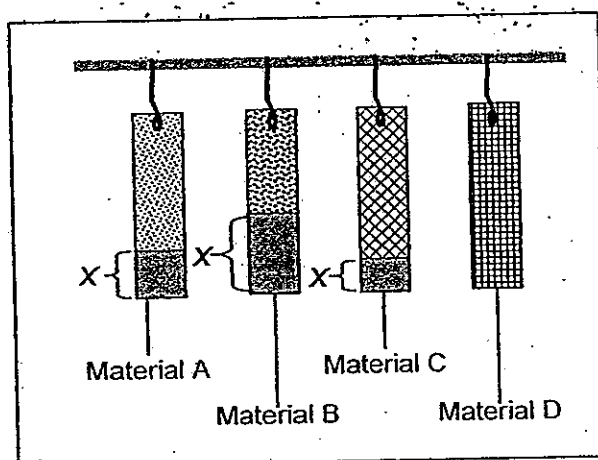

Key:

X refers to the length of material that was stained by the coloured water (cm).

The results of her measurements are shown in the table below.

Material	X (cm)
A	6
B	10
C	4
D	0

- (a) Based on the results above, which material would Sandra use to make a bath towel? Give a reason for your answer. (1m)

- (b) Which material would she choose to make a raincoat? Give a reason for your answer. (1m)

39. Beth had three iron bars, Iron bar 1, 2 and 3. Two of the iron bars are magnets while **one is not** a magnet. She labelled the ends of the bars as shown in the diagrams below.

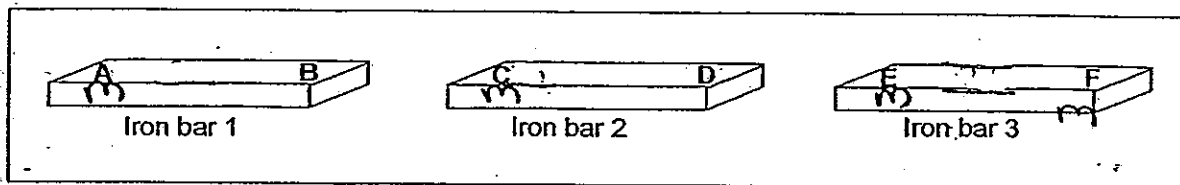

She brought the ends of the iron bars close to each other to find out how the bars would interact. The results are shown in the table below.

Ends that were brought close to each other	Observations
A and C	Attract
B and D	Attract
A and E	Repel
C and F	Attract

- (a) Based on the results above, which one of the iron bars is not a magnet? (1m)

Iron bar _____ is not a magnet.

- (b) What would happen when the ends of the iron bars in the table below were brought close to each other? Write the word 'Attract' or 'Repel' for your answers in the table below. (2m)

Ends that were brought close to each other	Observations
C and E	
B and F	

40. Chloe was given a beaker of water containing some iron filings and coarse sand as shown in the diagram below.

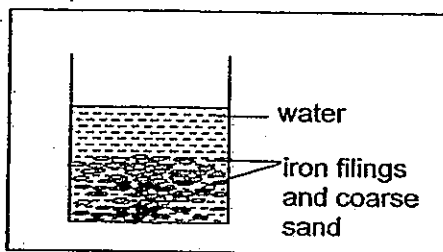

She was instructed to separate the iron filings and the coarse sand from the water. Show how Chloe can separate the two substances from the water using **both** items in the diagram below. **Write** your answers in the table below. (4m)

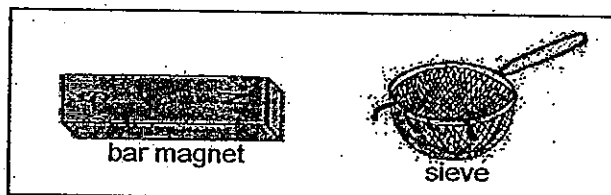

Steps	Description	What is separated?
Step 1		The is /are separated from the
Step 2		The is /are separated from the

41. Jolene had three measuring cylinders. She poured equal amounts of water into each cylinder. Then, she placed objects A, B and C, into the measuring cylinders as shown in the diagram below. She observed changes in the water levels.

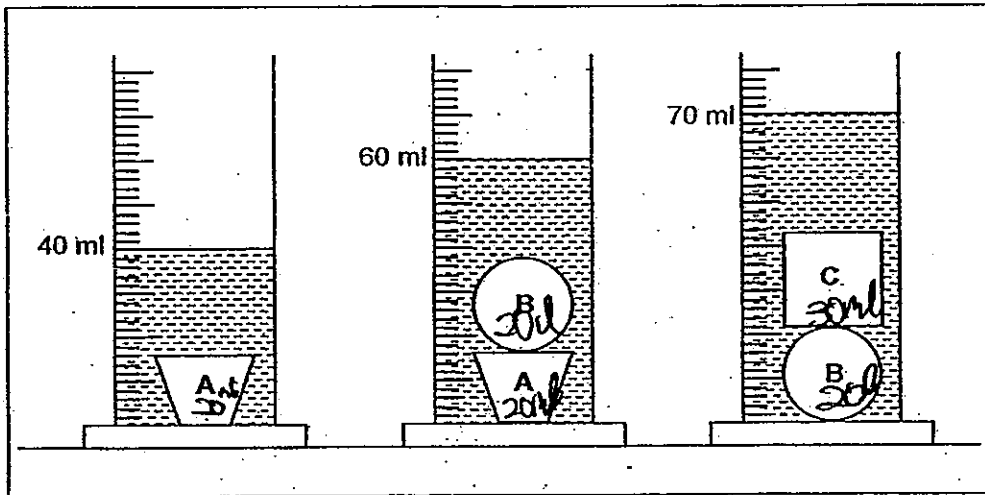

Four statements about Jolene's observations are given below. Study the diagrams and indicate whether each of the statements is 'True', 'False' or 'Not possible to tell'. Put a tick (✓) in the correct box. (3m)

	Statements	True	False	Not possible to tell
(a)	The volume of block B is 20 ml.			
(b)	The original volume of water is 30 ml.			
(c)	The volume of block C is lesser than the volume of block A.			
(d)	The volume of block B is greater than the volume of block A.			

42. Sally wanted to find out the volume of a lump of plasticine using the displacement of liquid method. She prepared the set-up as shown in the diagram below.

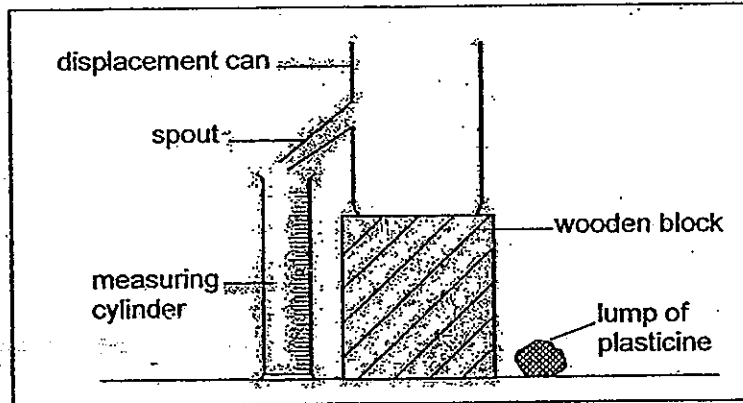

The table below shows the instructions that Sally needed to follow in order to find the volume of the lump of plasticine.

- (a) Arrange the instructions in the **correct** order using the numbers, '1', '2' and '3' (1: 1st step, 2: 2nd step, 3: 3rd step) in the boxes below. (2m)

	Procedure	Step
(i)	Gently place the lump of plasticine into the displacement can.	
(ii)	Pour water into the displacement can until it reaches just below the spout.	
(ii)	When the water has stopped flowing from the spout, note the volume of water in the measuring cylinder.	

- (d) State the property that the lump of plasticine **must** have, in order for the above method to work. (1m)

43. The diagram below shows the shapes of the shadows produced when two different objects of different materials were placed between a screen and a torch. The measurements of the objects are given in the box on the right.

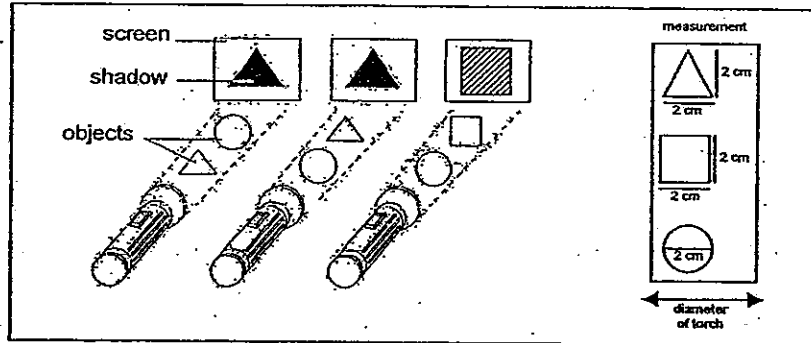

- (a) State whether the objects are made of 'Transparent', 'Translucent' or 'Opaque' materials. Write your answers in the table below. (2m)

	Object	Materials
(i)	○	
(ii)	△	
(iii)	□	

Both the square and the triangular objects were then placed in front of the screen in the order as shown in the diagram below.

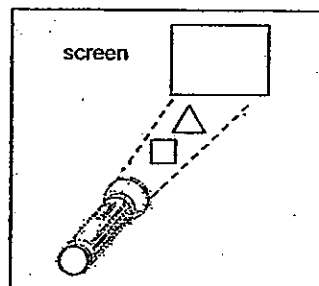

- (b) In the box below, **draw and shade** the shadow of the above objects as seen on the screen. (1m)

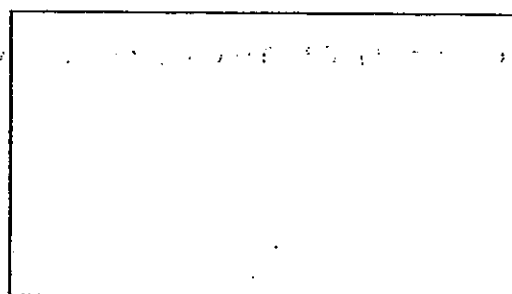

Key

■ opaque

▨ translucent

44. Janice set up an experiment as shown in the diagram below.

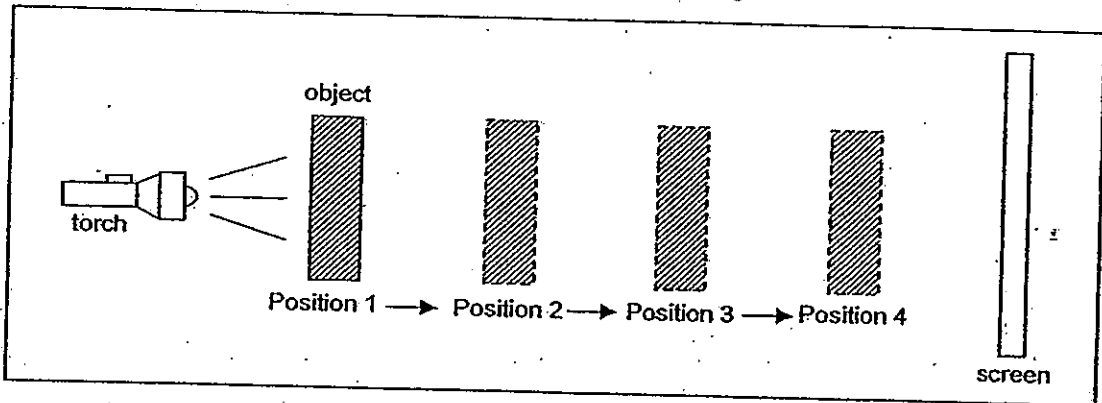

Fixing the position of the torch and the screen, Janice moved the object towards the screen from Position 1 to 4. Then she measured the length of the shadow at each position and plotted a line graph to show her results.

- (a) In the box provided below; draw a line to show the relationship between the length of the shadow and the position of the object correctly. (1m)

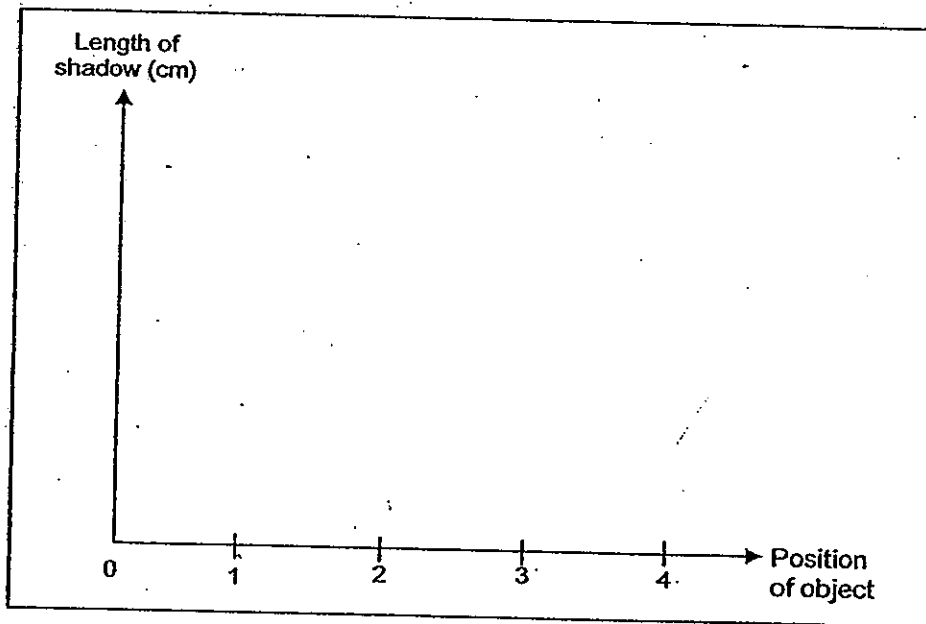

- (b) What is the relationship between the position of the object and the length of its shadow? (1m)

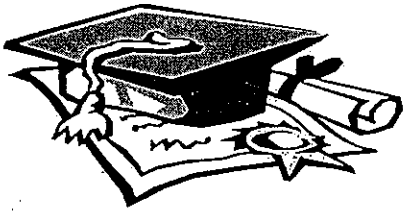

ANSWER SHEET

EXAM PAPER 2010

SCHOOL : METHODIST GIRLS' SCHOOL PRIMARY

SUBJECT : PRIMARY 4 SCIENCE

TERM : SA1

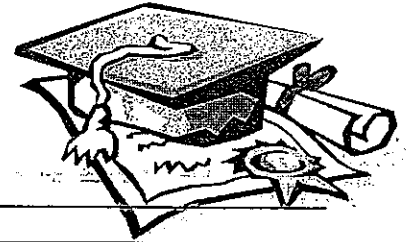

Q1	Q2	Q3	Q4	Q5	Q6	Q7	Q8	Q9	Q10	Q11	Q12	Q13	Q14	Q15	Q16	Q17
2	1	3	3	3	3	3	2	3	4	1	3	2	3	2	3	1

Q18	Q19	Q20	Q21	Q22	Q23	Q24	Q25	Q26	Q27	Q28	Q29	Q30
4	1	3	2	2	3	3	2	3	3	1	1	1

33a) The larger surface area of the leave of the teak tree allows the leaf to receive the maximum amount of sunlight.

33b) The leaves are needle-like to minimize the loss of water in the desert.

34a) Group A: smooth edge Group B: jagged edge

34b)

Pair of Leaves	Common Characteristics
C and F	Heart- shaped
B and G	Lobed- shaped

35a)

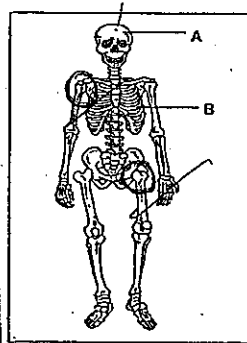

35b) To allow us to move.

35c) Part A protects the brain while Part B protects the heart, they both protect something.

35d) The muscular system.

36a) Animal X: fish Animal Y: mammal

36bi) To become bigger.

37a) This is to ensure that the cockroaches are at the same place from the four different kinds of food so that the experiment will be a fair test.

37b)

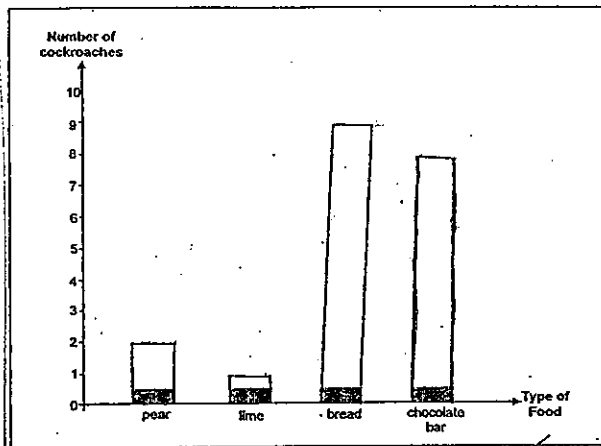

38a) Material B, it absorbs the most water.

38b) Material D, because it is waterproof and does not allow water to pass through.

41a) True b) Not possible to tell c) False d) Not possible to tell

42ai) Step 2 aii) Step 1 aiii) Step 3

42d) It must have a definite volume and it must sink.

43ai) Transparent 43aii) Opaque 43aiii) Translucent

43b)



44a)

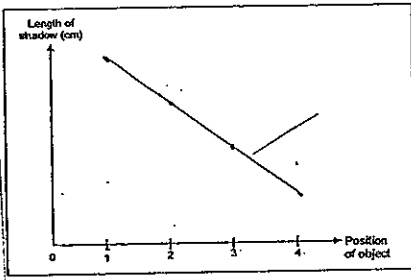

44b) The nearer the object is to the light source, the bigger the shadow will be and the nearer the object is to the screen, the smaller the shadow will be.