



RAFFLES GIRLS' PRIMARY SCHOOL

SEMESTRAL ASSESSMENT (2)  
2009

Your score out of 90 marks		
Highest score	Class	Level
Average score		
Parent's signature		

Name : \_\_\_\_\_ Index No.: \_\_\_\_\_ Class: P4 \_\_\_\_\_

30<sup>th</sup> October 2009

SCIENCE

ATT: 1 h 20 min

SECTION A (25 x 2 marks)

For each question from 1 to 25, four options are given. One of them is the correct answer. Make your choice (1, 2, 3 or 4). Shade the correct oval on the Optical Answer Sheet (OAS) provided.

1. The stages in the life cycle of a mosquito are shown below. [Stages A, B, C and D are NOT arranged in order.]

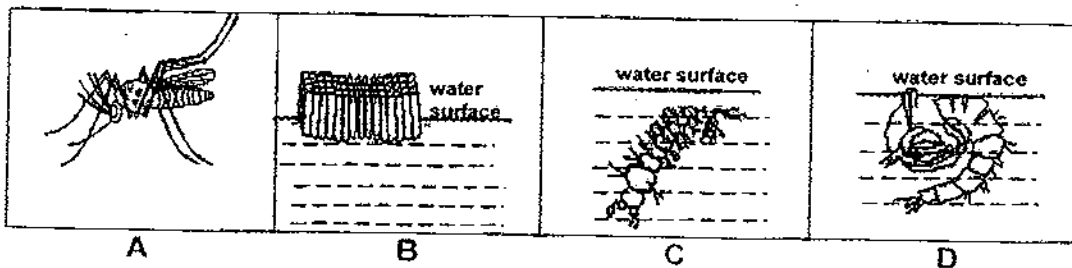

Which one of the following diagrams shows the correct order of the stages in the life cycle of a mosquito?

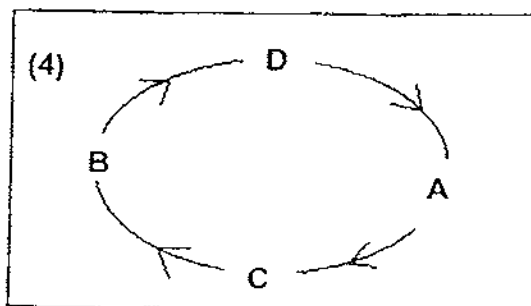
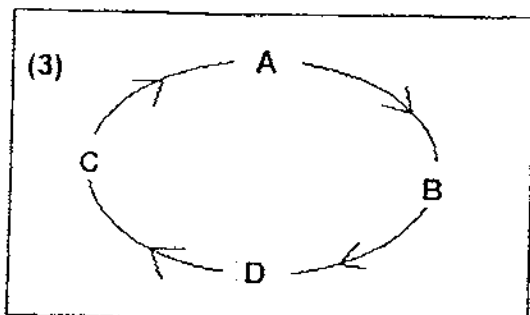
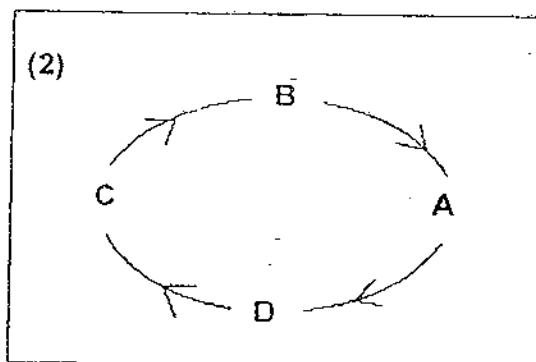
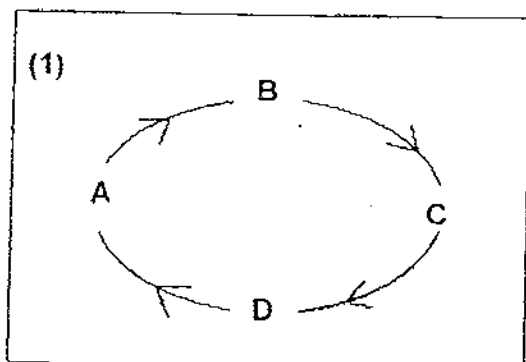

2. Fandi did a study on two animals, X and Y.

He recorded his observations in the table below.

A tick (✓) in the box indicates the observation made of the animal.

observation	animal X	animal Y
There are 3 stages in its life cycle.	✓	
Its eggs are laid on land.	✓	✓
Its young do NOT have wings.	✓	✓

Which one of the following sets identifies animal X and animal Y correctly?

	animal X	animal Y
(1)	chicken	mosquito
(2)	butterfly	chicken
(3)	cockroach	butterfly
(4)	mosquito	cockroach

In the diagrams below, A, B, C and D, represent the different stages in the life cycle of a flowering plant.

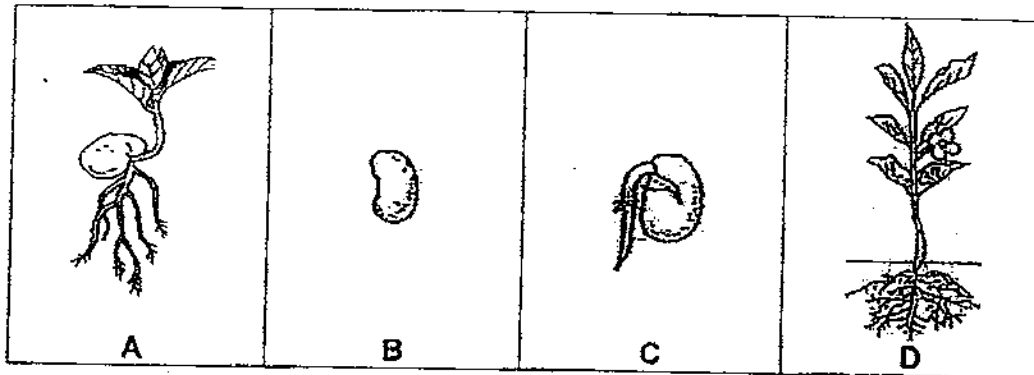

Based on the diagrams above, answer questions 3 and 4.

3. Which one of the following shows the correct order of stages in the life cycle of a flowering plant?

	1st stage	→		last stage
(1)	A	B	C	D
(2)	B	C	A	D
(3)	C	D	B	A
(4)	D	A	C	B

4. Which of the following does the flowering plant need at stage A to carry out photosynthesis?

- A light
- B heat
- C water
- D oxygen

- (1) A and C only
- (2) B and D only
- (3) A, C and D only
- (4) A, B, C and D

5. Four pupils, Alison, Bakar, Chris and Devi, made the following statements about a plant.

Alison : Flowers develop from the buds.

Bakar : A seed cannot grow without light.

Chris : The seedling makes its own food when its first shoot appears.

Devi : Seeds need air, water, warmth and carbon dioxide to germinate.

Who made the correct statements?

- |                                  |                                |
|----------------------------------|--------------------------------|
| (1) Alison only                  | (2) Alison and Chris only      |
| (3) Alison, Bakar and Chris only | (4) Bakar, Chris and Devi only |

The diagram below shows parts of the digestive system of a human.

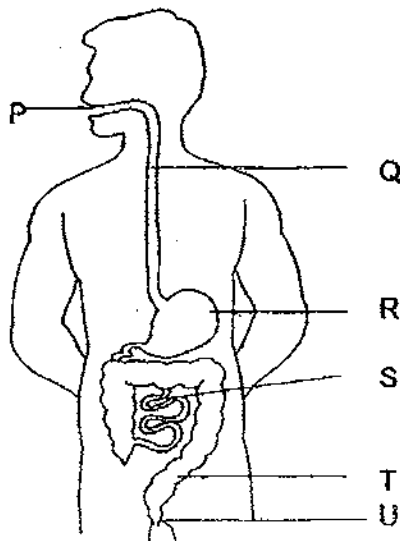

Based on the diagram above, answer questions 6, 7, 8, 9 and 10.

6. Which of the sentences below best describe(s) the teeth present in P?

- A They speed up digestion.
- B They grind the food in P into smaller pieces.
- C They produce saliva to moisten the food in P.
- D They break down the food so that it can be digested easily.

- |                  |                  |
|------------------|------------------|
| (1) A only       | (2) C only       |
| (3) A and B only | (4) B and D only |

7. Which of the following statements describe(s) correctly the function(s) of the digestive juices in P?

- A It softens the food in P.
- B It helps to digest the food in P.
- C It removes water from the food in P.

- (1) A only
- (2) C only
- (3) A and B only
- (4) B and C only

8. Which one of the following sets best describes what take place at Q, R and S correctly?

	Q	R	S
(1)	allows food to flow through	digestion takes place	digested food is absorbed
(2)	digestion takes place	allows food to flow through	digested food is absorbed
(3)	water is being removed	digestion takes place	allows food to flow through
(4)	allows food to flow through	digested food is absorbed	digestion takes place

9. In which one of these organs, Q, R, S or T, is water being removed?

- (1) Q
- (2) R
- (3) S
- (4) T

10. The table below shows a comparison between what happen at S and T.

	at S	at T
A	Food is being digested.	Food is completely digested.
B	It passes digested food to T for further digestion.	Undigested food is absorbed into the blood stream.
C	Food is digested completely.	Undigested food is passed to U for removal.

Which one of the following sets of comparisons is/ are correct for both S and T?

- (1) A only
- (2) C only
- (3) A and B only
- (4) B and C only

11. The following box shows a list of different functions of the various parts of a land plant.

A	makes food for the plant
B	takes in water and mineral salts
C	contains and protects the seeds
D	holds the plant firmly to the ground
E	supports and spreads out the branches and leaves
F	transports food, water and mineral salts to all parts of the plant

Which one of the following parts of the plant is matched correctly to its functions?

	part of a plant	functions
(1)	leaf	A and D
(2)	stem	E and F
(3)	fruit	A and B
(4)	root	C and E

12. The diagrams below show plant X and plant Y.



plant X



plant Y

Which one of the statements below is true about both plants X and Y?

- (1) Both plants have weak stems.
- (2) Both plants do not have fruits.
- (3) Both plants use their roots to cling onto supports.
- (4) Both plants need to cling onto supports to reach out for food.

13. Bethany placed a plant in a beaker filled with red-coloured water.

After a day, she observed that some parts of the stem, leaves and flower of the plant turned red. She cut the stem of the plant at two parts, X and Y, as shown in the diagram below.

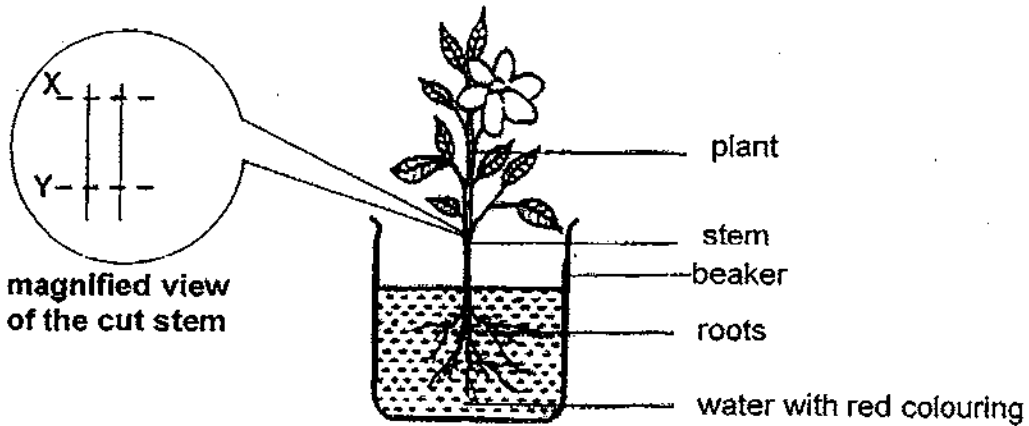

Bethany observed that the cross-sections of parts X and Y look like these:

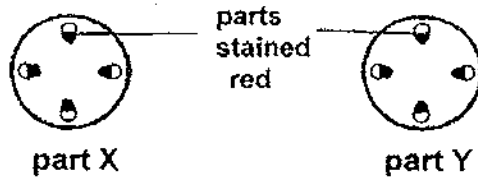

What could Bethany conclude from her experiment?

- A There are tubes in the stem.
- B The tubes carry the red-coloured water to the roots.
- C The tubes in the stem can transport the red-coloured water to all parts of the plant.

- (1) A and B only
- (3) B and C only

- (2) A and C only
- (4) A, B and C

14. The flow chart below is used to differentiate matter A and matter B.

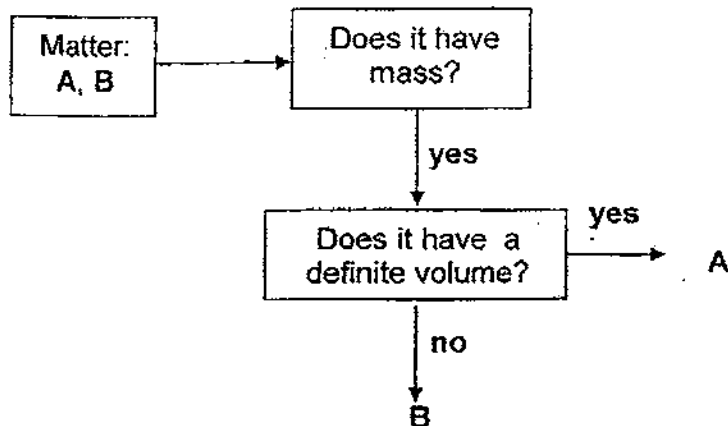

Which one of the following pairs identifies A and B correctly?

	A	B
(1)	gas	liquid
(2)	solid	gas
(3)	gas	solid
(4)	solid	liquid

15. John pushed an inverted plastic cup into a basin of water as shown in the diagram below.

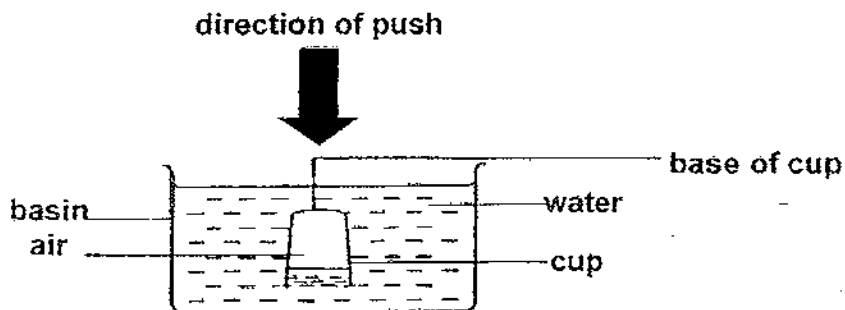

John noticed that the cup was **NOT** filled completely with water. How could John fill the cup completely with water?

- A Add more water into the basin  
 B Tilt the cup slightly at an angle  
 C Make a hole at the base of the cup  
 D Push the cup straight down directly to the bottom of the basin
- (1) A only  
 (2) C only  
 (3) A and D only  
 (4) B and C only



16. A stick is stuck to the ground. The rays from the sun fall on the stick as shown in the diagram below.

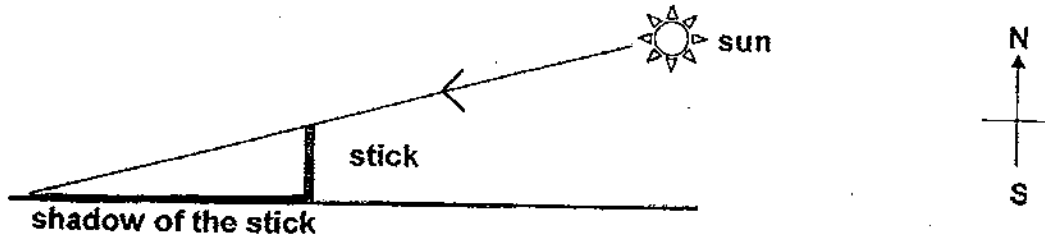

Which one of the following diagrams shows correctly the length of the shadow of the stick from 9 a.m. to 6 p.m.?

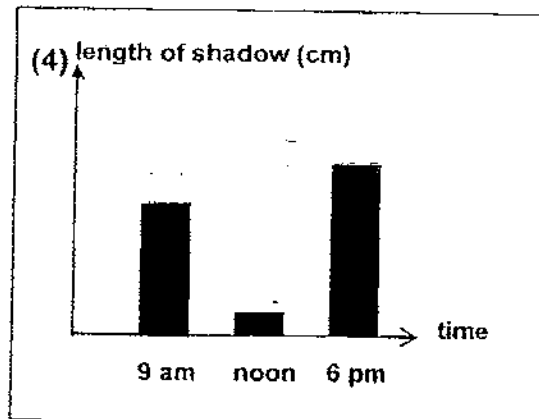
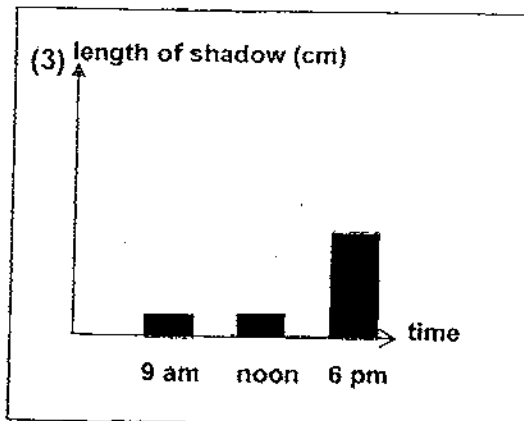
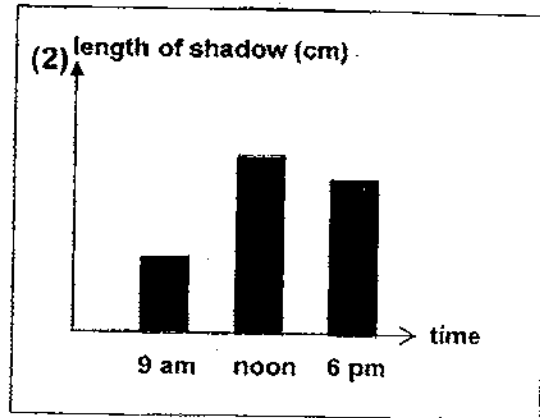
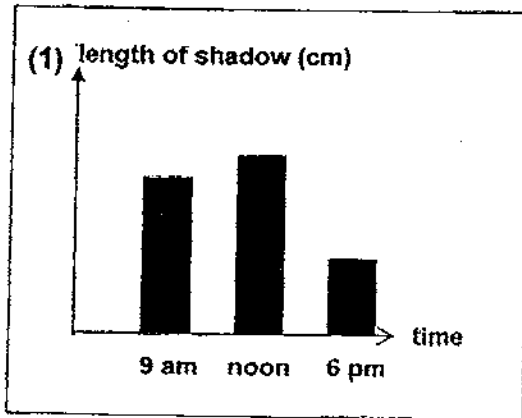

17. Jenny used the following apparatus to see a rubber duck at one end of a bent tube.

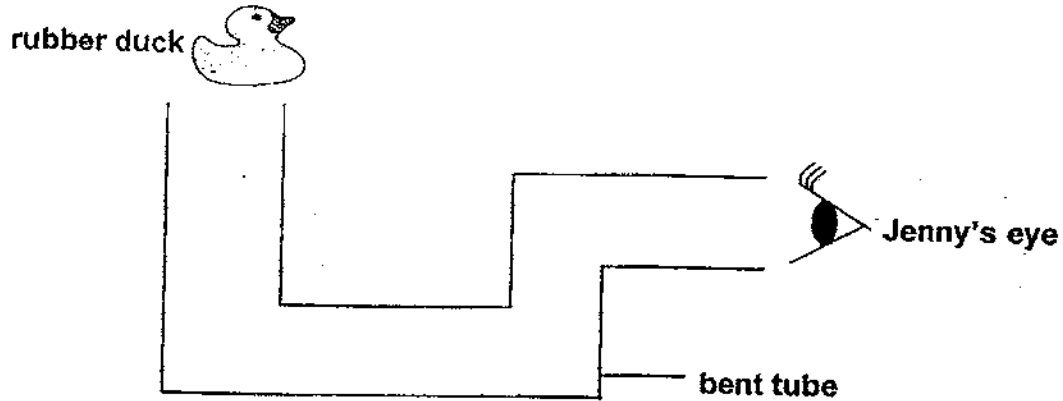

What was the least number of mirrors that Jenny would need to put into the bent tube to see the rubber duck?

- |           |          |
|-----------|----------|
| (1) five  | (2) two  |
| (3) three | (4) four |

18. When Ali switched on the light source, a dark shadow of the ball was cast on the screen as shown below.

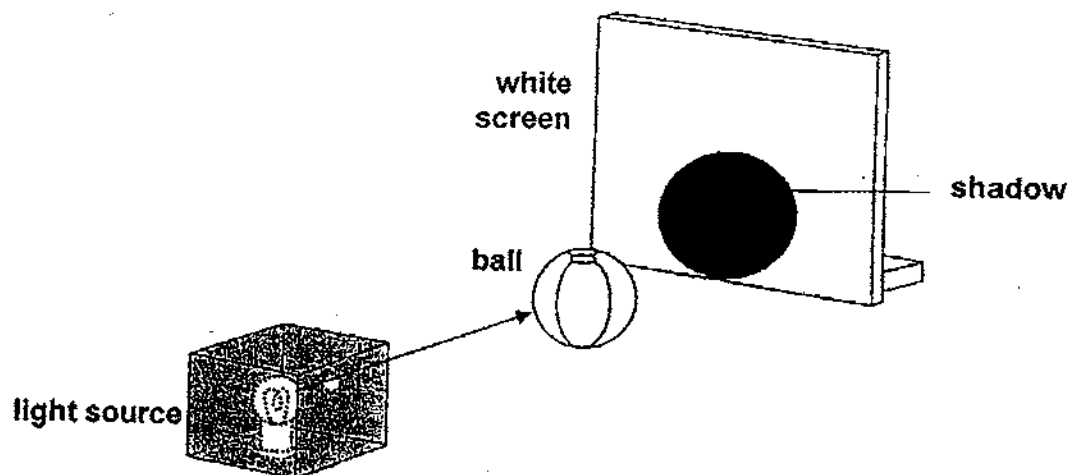

What would happen to the shadow of the ball when the ball was moved nearer to the screen?

[NOTE: The ball moved along the path of light.]

- A The shadow of the ball became larger.
- B The shadow of the ball became smaller.
- C The shape of the shadow remained the same.

- (1) A only
- (2) C only
- (3) A and C only
- (4) B and C only

19. Dalia could **NOT** open the cap of a bottle. Her mother told her to place the cap of the bottle into a basin of hot water as shown in the diagram below.

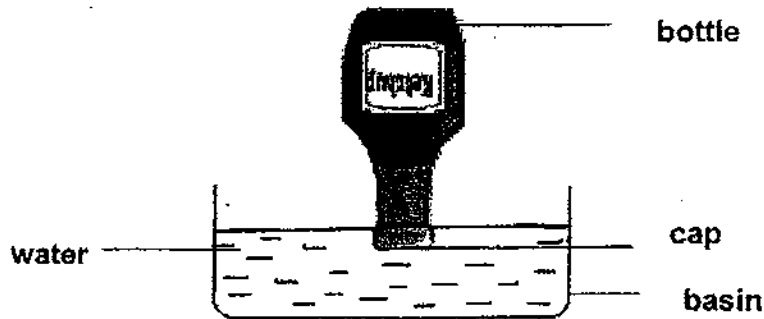

Which one of the following statements explains how the bottle cap could be removed?

- (1) The hot water caused the cap to expand.
- (2) The hot water caused the cap to contract.
- (3) The hot water caused the bottle to contract.
- (4) The hot water caused the air in the bottle to expand.

Wendy had 3 cups of the same size. Each cup was made of a different material, A, B and C, of the same thickness. She put an equal amount of ice cubes into each cup.

Then, Wendy placed all the cups into a plastic container of hot water as shown below.

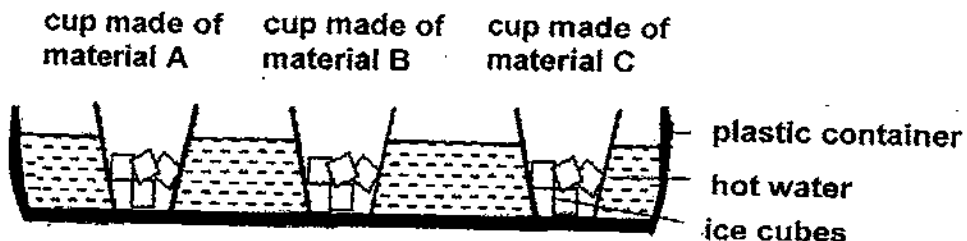

Wendy recorded the time taken for the ice cubes to melt completely in each cup in the graph below.



Based on the information above, answer questions 20 and 21.

20. What was the aim of Wendy's experiment?
- (1) To find out how ice cubes melt
  - (2) To show the different states of water
  - (3) To find out if water is a good conductor of heat
  - (4) To show that different materials conduct heat at different rates
21. Which of the following statements explain(s) correctly why the ice cubes take the longest time to melt in the cup made of material C?
- A Material C is the poorest conductor of heat.
  - B Heat could not pass through the cup made of material C easily.
  - C Heat in the cup made of material C was transferred to the water in the plastic container.
- (1) C only
  - (2) A and B only
  - (3) B and C only
  - (4) A, B and C

22. Qingru made use of the flow chart below to classify 4 objects: an eraser, a piece of aluminium foil, a copper coin and a steel can.

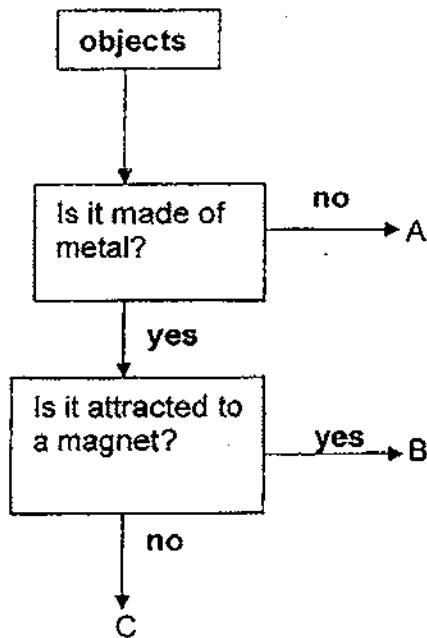

Which one of the following sets identifies correctly objects A, B and C?

	A	B	C
(1)	eraser	steel can	aluminium foil, copper coin
(2)	copper coin	aluminium foil	steel can, eraser
(3)	eraser	copper coin	steel can, aluminium foil
(4)	aluminium foil	steel can	copper coin, eraser

23. Sandra arranged 4 bar magnets, A, B, C and D, in the manner as shown below.

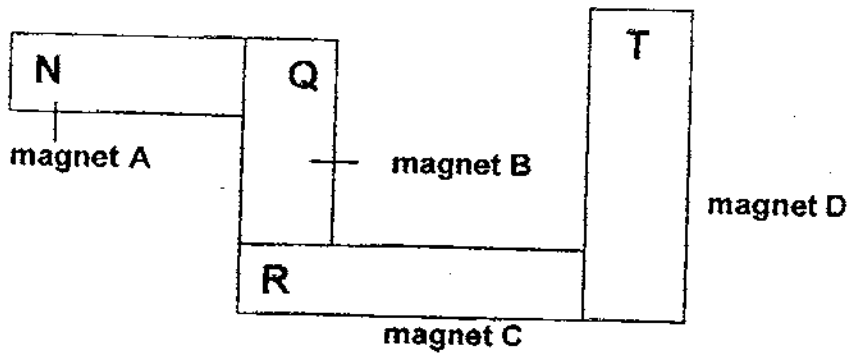

The magnets were attracted to one another.  
The letter N on magnet A indicates its North pole.

What are the poles of magnets B, C and D as indicated by the letters, Q, R and T respectively?

	Q	R	T
(1)	South	North	North
(2)	South	South	North
(3)	North	North	South
(4)	North	South	South

24. Charmaine placed a compass near end P of a strong bar magnet as shown in the diagram below.

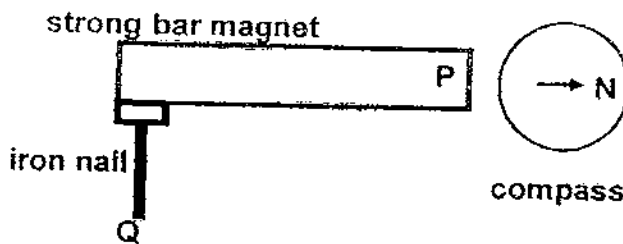

Which one of the following represents correctly the poles at P and Q?

	P	Q
(1)	South	South
(2)	North	North
(3)	North	South
(4)	South	North

25. Jaimie placed a ping pong ball at the edge of a table.

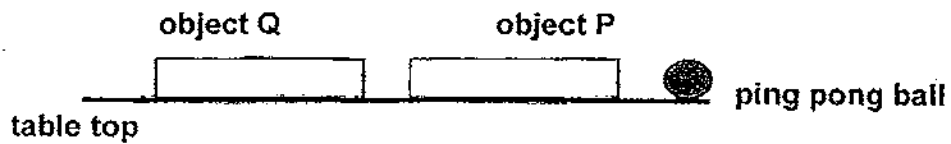

When she put object Q near to object P as shown in the diagram above, the ping pong ball was pushed off the table by object P.

Which one of the following statements best describes object P and object Q?

- (1) Object P is a magnet and object Q is made of a magnetic material.
- (2) Object Q is a magnet and object P is made of a magnetic material.
- (3) Both P and Q are magnets with their like poles facing each other.
- (4) Both P and Q are magnets with their unlike poles facing each other.



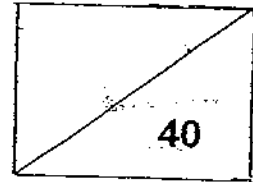

Name: \_\_\_\_\_ Index No : \_\_\_\_\_ Class: P4 \_\_\_\_\_

**SECTION B (40 marks)**

For questions 26 to 38, write your answers clearly in the spaces provided.

The number of marks available is shown in the brackets [ ] at the end of each question or part question.

26. The diagram below shows the different stages involved in the life cycle of animal X.

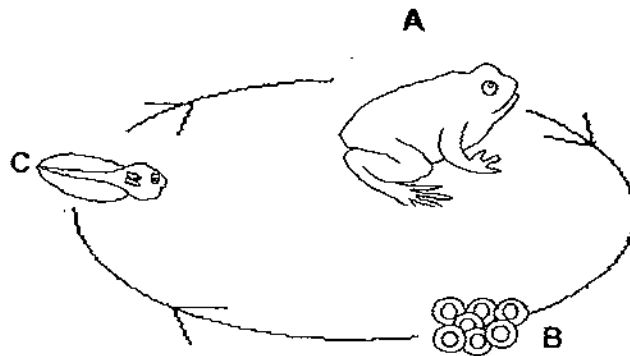

Based on the diagram above, answer the following questions:

(a) What is the young of animal X known as at stage C? [1]

\_\_\_\_\_

(b) List **TWO** differences between stages A and C. [Do NOT compare size.] [2]

1 <sup>st</sup> DIFFERENCE	
2 <sup>nd</sup> DIFFERENCE	

27. The diagrams below show the different stages in the life cycles of animals X and Y.

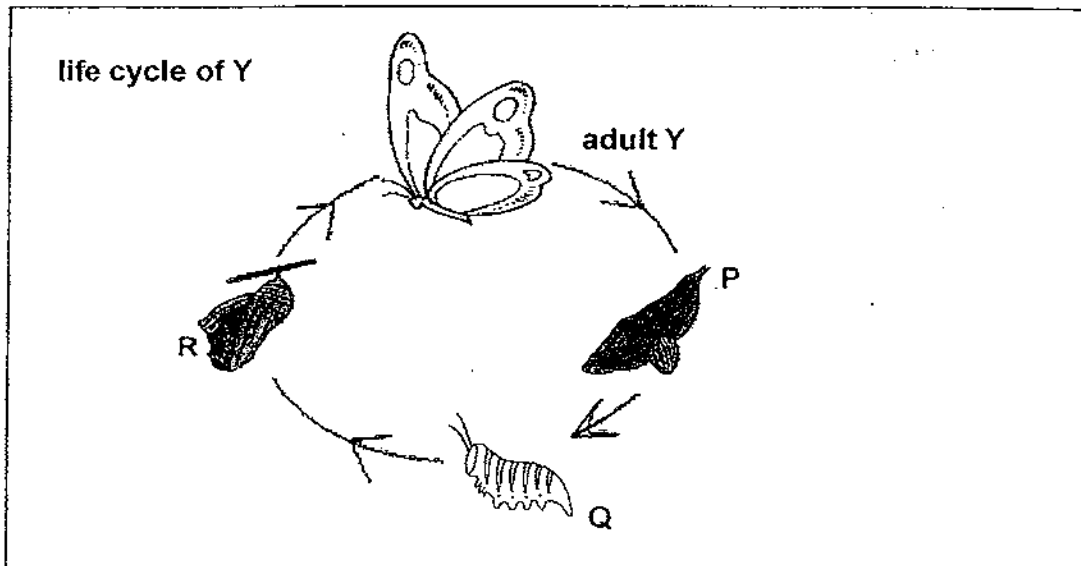
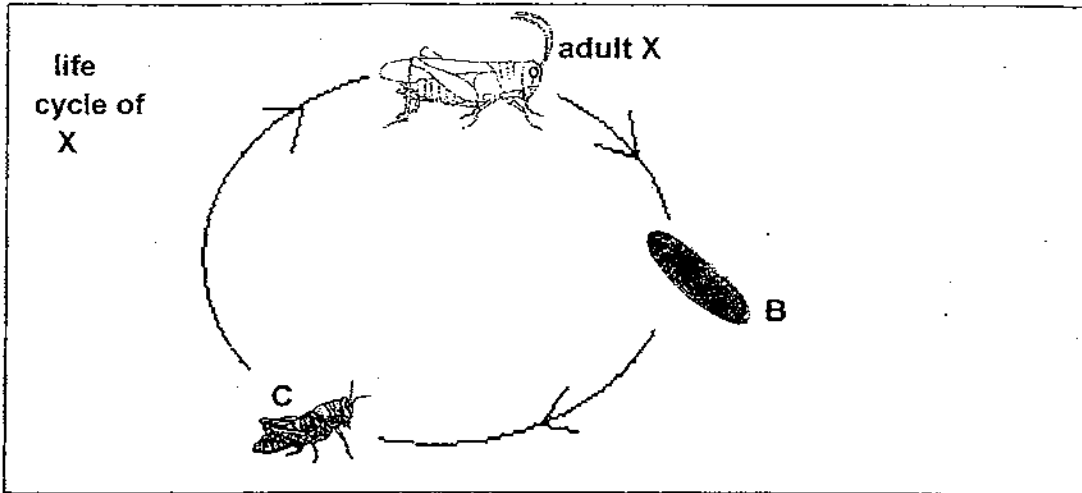

Based on the diagrams above, answer the following questions:

(a) What is Y known as at stage P? [1]

(b) Compare the life cycles of X and Y.

(i) State one difference. [1]

(ii) State one similarity. [1]

28. The diagrams below show the different body systems found in man.  
Match each system correctly to its function.

Each system can be matched to **ONE** function only.

[2]

body system

function

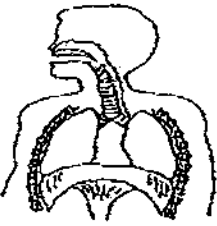
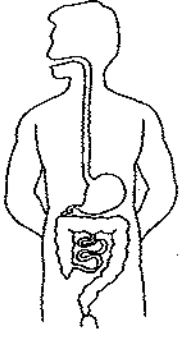
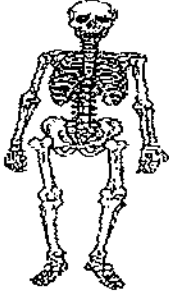
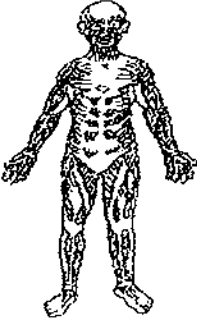
	<p>breaks down food into simple substances</p>
	<p>helps in body movements</p>
	<p>protects vital organs</p>
	<p>allows gaseous exchange to take place</p>

29. The following processes, A, B, C and D, take place in the various parts of the digestive system.

- A food is digested and absorbed into the blood stream
- B saliva is produced to break down food
- C partially digested food is pushed down the tube
- D undigested food is stored here to be passed out

(a) Arrange the processes A, B, C and D according to the order that each takes place in the different parts of the human digestive system.

Write the letters A, B and C in the correct boxes below.  
D has been written for you.

[1]

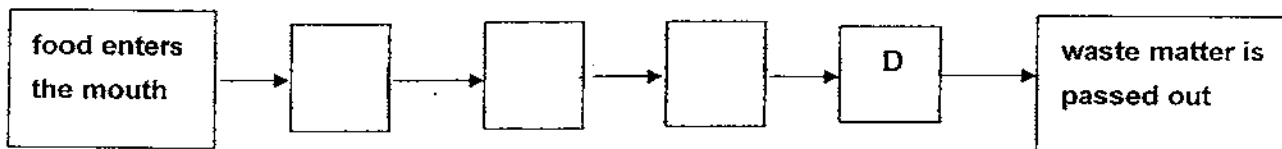

(b) Name the parts of the digestive system where digestive juices are produced.

[3]

---

---

30. The diagram below shows a body system found in man.

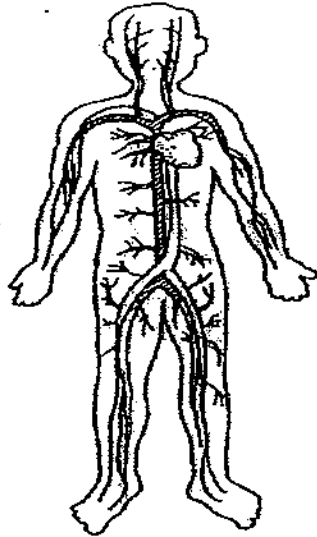

Based on the diagram above, answer the following questions:

(a) Name the system. [1]

\_\_\_\_\_

(b) Name **TWO** parts of the system. [2]

(i) \_\_\_\_\_

(ii) \_\_\_\_\_

31. The graph below shows the length of the root and shoot of a germinating seed.

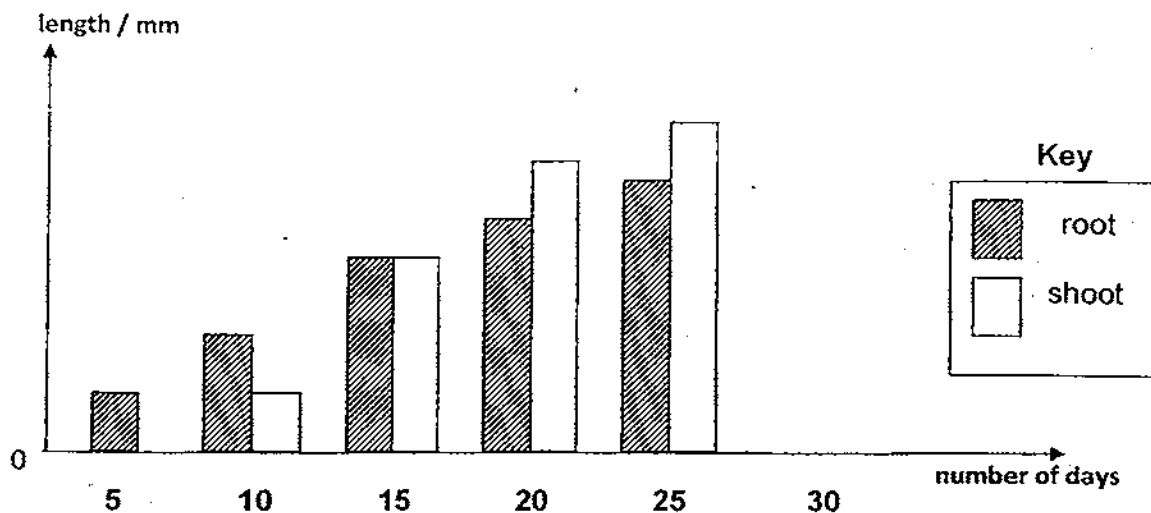

Based on the graph above, answer the following questions:

(a) Which part of the seed grows out first? [1]

---

(b) State **ONE** similarity between the length of the root and shoot of the germinating seed from Day 5 to Day 25. [1]

---

(c) Predict the new length of the root and shoot of the germinating seed on the 30th day.

**DRAW** and **SHADE** appropriately on the graph given above. [1]

32. Diagram Y shows a measuring cylinder filled with some water and stone B in it.

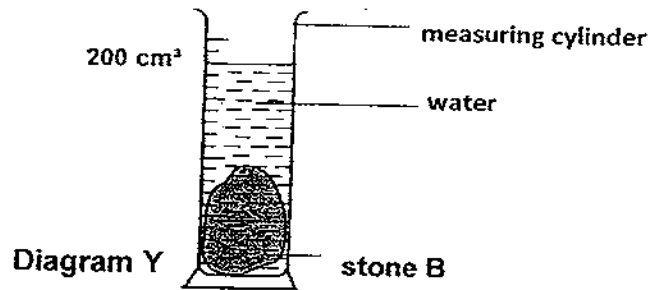
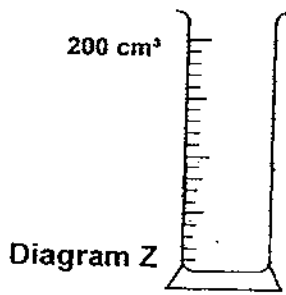

Diagram Z below shows the same measuring cylinder **WITHOUT** stone B. The volume of stone B is 120 cm<sup>3</sup>.

(a) **DRAW** the water level on **Diagram Z WITHOUT** stone B. [1]



(b) Give **ONE** conclusion about stone B based on the above observations. (Do **NOT** mention the volume of stone B.) [1]

---



---

(c) When stone B is dropped into the **SAME** measuring cylinder filled with liquid M, the stone is totally covered by the liquid.

Will the volume of stone B remain as 120 cm<sup>3</sup>?

Give a reason for your answer.

[1]

---



---

33. Alex had an object A as shown below.

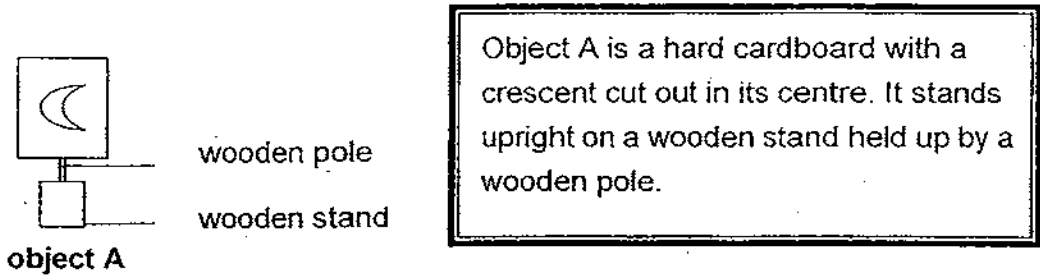

Alex placed object A, with its cut-out crescent facing the torch, between a lighted torch and the wall in a straight line as shown below.

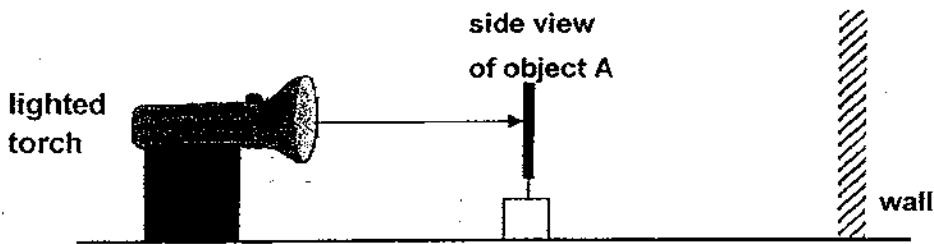

Alex saw a dark shadow of object A cast on the wall.

(a) **DRAW** the shadow of object A that Alex saw on the wall in the box given below. [2]

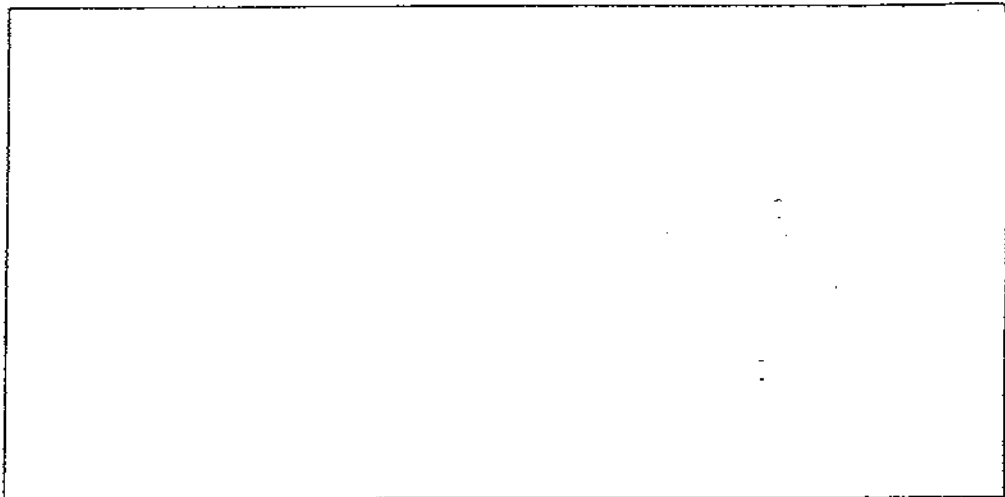

(b) Why was object A able to cast its shadow on the wall? [1]

---



---



34. Cathy cooked some soup in a pot on a hot stove.

She switched off the stove and poured out the soup into two identical bowls. She used a metal spoon to stir the soup in one bowl and another similar spoon made of plastics in the other bowl.

Next, Cathy left both spoons in the bowls as shown in **Diagram 1** and **Diagram 2** below.

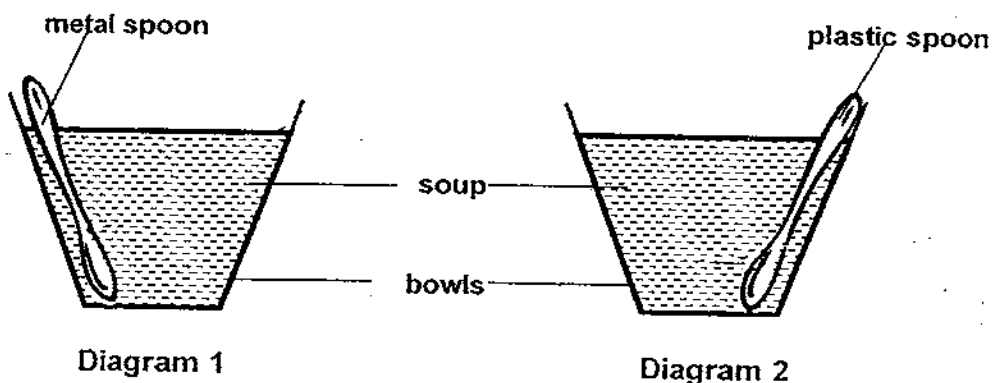

(a) A few minutes later, Cathy lifted both spoons and found that the metal spoon was hotter than the plastic spoon.

Explain why the metal spoon was hotter than the plastic spoon. [1]

---



---

(b) Half an hour later, Cathy measured the temperatures of the soup in the bowl and of the metal spoon. Both the temperatures were the same.

Give a reason why it was so. [2]

---



---

(c) **DRAW** an arrow (→) in each diagram to show the direction in which heat travelled in each bowl on **Diagram 1** and **Diagram 2** above. [1]

35. Ben placed a drop of blue ink in a glass tube connected to flask A.

Next, Ben immersed the flask in a basin of cold water as shown below.

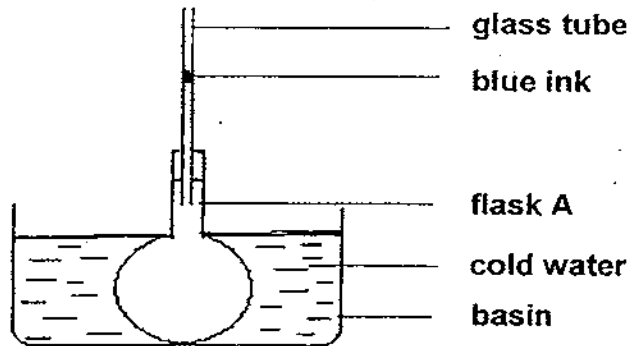

Based on the information above, answer the following question:

Ben noticed that the drop of blue ink in the glass tube rose first and then fell.

Explain how this could have happened.

[2]

---

---

---

---

36. A, B, C and D are magnets hanging from strings of two different lengths as shown in the diagram below.

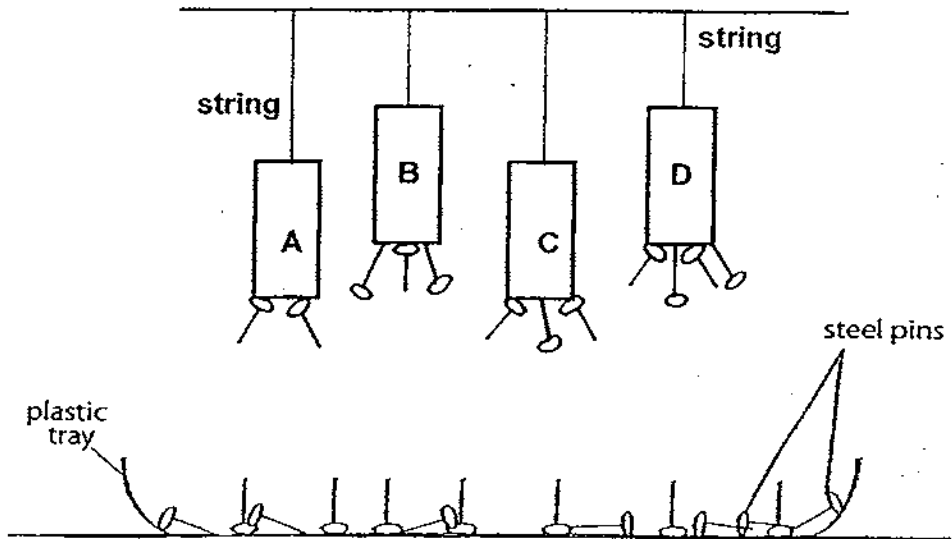

A plastic tray of steel pins is placed directly below the magnets and different numbers of pins are attracted to the magnets.

- (a) Based on the diagram above, arrange the magnets, A, B, C and D, according to their magnetic strength in ascending order.

Fill in the correct boxes with the letters A, B, C and D **ONLY**. [1]





strongest

Magnet A is re-tied and hung over the **SAME** tray of pins as shown below.

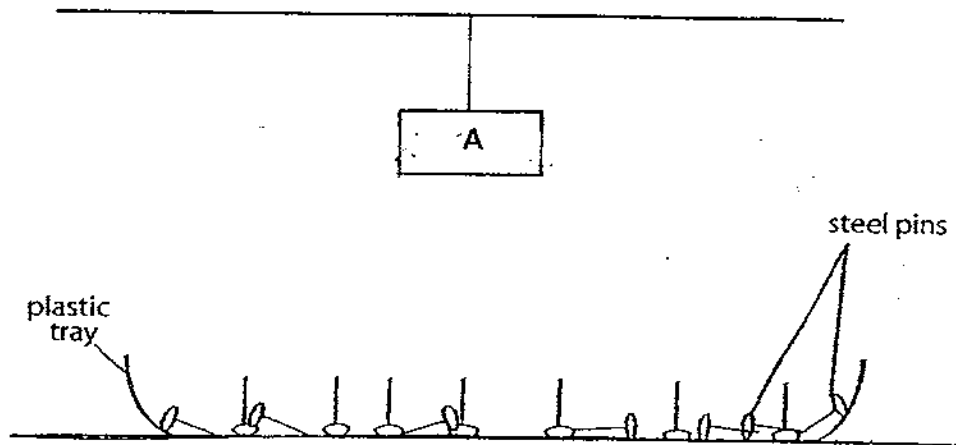

- (b) **MARK** a cross / crosses (X) on the part (s) of magnet A that attract(s) the most number of pins.

Give a reason for your answer.

[3]

37. Samantha brought the N-pole of a magnet near end P of object X as shown below.

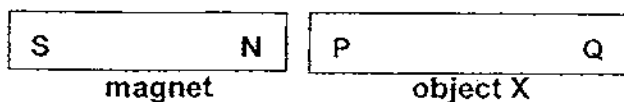

Next, she brought the N-pole of the same magnet to part Q of object X. She recorded her observations below.

part of object X	observation
P	P was attracted to the magnet.
Q	Q was repelled by the magnet.

Based on the information above, answer the following questions:

- (a) What was Samantha trying to find out? [1]

---



---

Samantha replaced object X with an aluminium rod. Its ends were marked Y and Z.

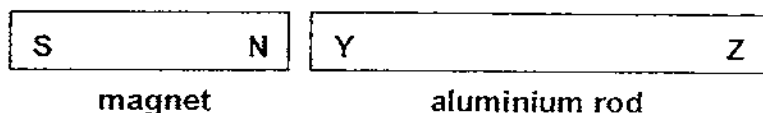

- (b) Using the **SAME** magnet, Samantha brought each end of the aluminium rod, Y and Z, **ONE** at a time, near the S-pole of the magnet. Record what Samantha would observe in the table below. [2]

part of aluminium rod	observation
Y	
Z	

- (c) What could Samantha conclude about the property of the aluminium rod? [1]

---

38. Trisha's teacher told her that an iron nail can become an electromagnet when it is placed in a coil of wire with its ends joined to batteries as shown in set-ups W and X below.

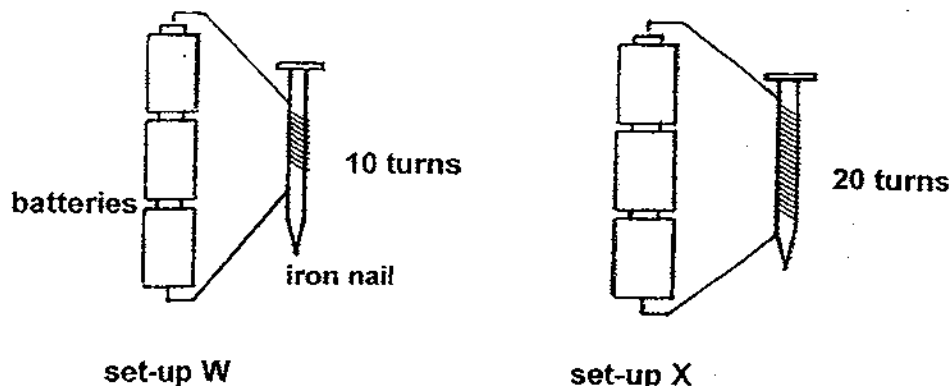

For each set-up, Trisha tested the strength of the electromagnet by counting the number of steel paper clips that each could attract. Trisha wound 10 more turns round the iron nail in set-up X and then recorded her observations in the table as shown below.

number of turns of wire round the iron nail	number of paper clips magnetised iron nail attracted
10	2
20	5
30	11

- (a) Based on Trisha's observations, what could she conclude about the number of turns of the wire round an iron nail and its magnetic strength? [1]
- \_\_\_\_\_
- \_\_\_\_\_
- (b) Name **ONE** variable that Trisha must keep the same to ensure that she carried out a fair test. [1]

- END OF PAPER -

Setters: Mr Johnson Ong, Mrs Christina Lim, Ms Haslina

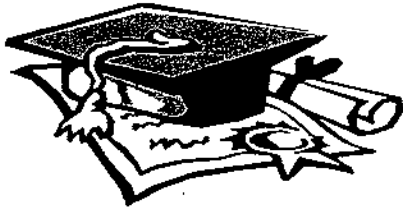

# ANSWER SHEET

**EXAM PAPER 2009**

**SCHOOL : RAFFLES GIRLS' PRIMARY**  
**SUBJECT : PRIMARY 4 SCIENCE**

**TERM : SA2**

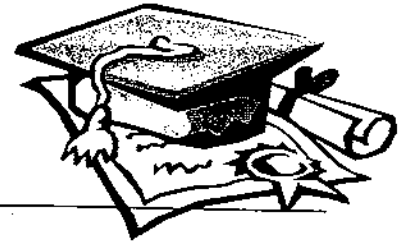

Q1	Q2	Q3	Q4	Q5	Q6	Q7	Q8	Q9	Q10	Q11	Q12	Q13	Q14	Q15	Q16	Q17
1	3	2	1	1	3	3	1	4	2	2	1	2	2	4	4	3

Q18	Q19	Q20	Q21	Q22	Q23	Q24	Q25
4	1	4	2	1	3	3	3

26)a) It is a tadpole.

b) 1<sup>st</sup> : A does not have a tail but C has a tail.

2<sup>nd</sup> : A has legs but C does not have legs.

27)a) It is known as the egg adult.

b)i) The life cycle of X has 3 stages while the life cycle of Y has 4 stages.

ii) Both life cycle have an egg stage.

28)



29)a) B → C → A → D

b) Mouth, stomach and small intestine.

30)a) Circulatory system.

b)i) Heart ii) blood vessels.

31)a) The roots grows out first.

b) The height increases day by day.

c)

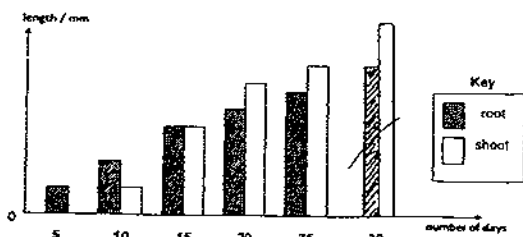

32)a)

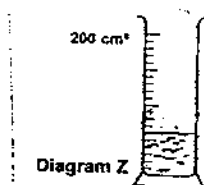

b) Stone B is a solid . Solid occupies space.

c) Yes. Stone B is a solid and solid has a definite volume.

33)a)

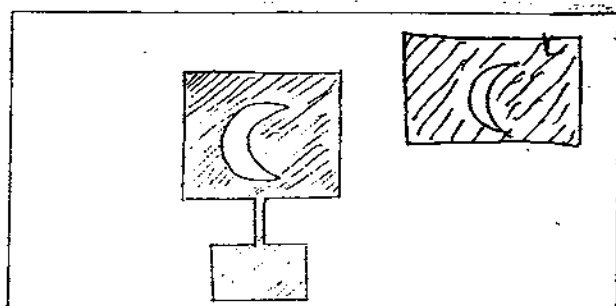

b)The light source was being blocked by object A, casting a shadow on the wall.

34)a)Metal spoon is a better conductor of heat than the plastic spoon.

b)The soup lost heat and the metal spoon gained heat until both reached the same temperature.

c)

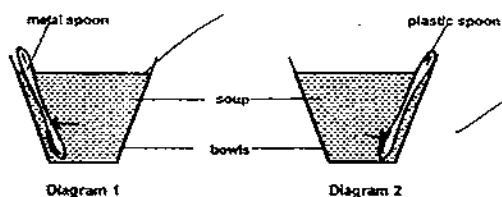

35)The flask contacted first then the air in the flask contracted. When the flask contracted, the air in the flask enters the glass tube, causing the blue ink to rise. When the air inside the flask contracted, the ink then drop to take up the space previously taken up by the air.

36)a)A, C, B, D

b)The poles of the magnet are strongest in attraction and to repel.



**37)a) Samantha was trying to find out if object X is a magnet.**

**b) Y: The magnet did not move.**

**Z: The magnet did not move.**

**c) Aluminium is not a magnetic material.**

**38)a) The more number of turns wire round the iron nail, the more number of paper clips will be attracted.**

**b) The number of batteries.**