



Anglo-Chinese School
(Primary)

A Methodist Institution
(Founded 1886)

**SEMESTRAL ASSESSMENT TWO 2022
SCIENCE
PRIMARY FOUR
BOOKLET A**

Name: _____ ()

Class: Primary 4 _____

Date: 28 Oct 2022

Duration of paper: 1 h 45 min

INSTRUCTIONS TO CANDIDATES

1. Write your name, index number and class in the spaces provided.
2. Do not turn this page until you are told to do so.
3. Follow all instructions carefully.
4. Answer all questions.
5. Shade your answer on the Optical Answer Sheet (OAS) provided.

This question paper consists of 18 printed pages including this cover page.

For each question from 1 to 28, four options are given. One of them is the correct answer. Make your choice (1, 2, 3 or 4) and shade your answer on the Optical Answer Sheet.

(56 marks)

1 Which statement is true about most mammals?

- (1) They can fly.
- (2) They produce milk.
- (3) They have feathers.
- (4) They have three body parts.

2 Which of the following objects is not made of waterproof material?

(1)



plastic raincoat

(2)



metal spoon

(3)



rubber gloves

(4)

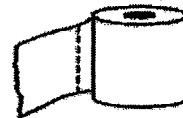

toilet paper

3 In which of the following will the two magnets push each other away?

(1)



(2)

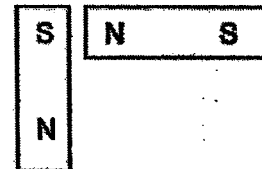

(3)

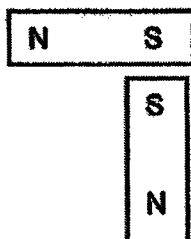

(4)

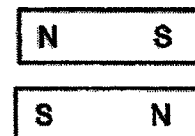

(Go on to the next page)

4 Which of the following is the function of a leaf on a plant?

- (1) makes food
- (2) takes in water
- (3) holds plant upright
- (4) takes in mineral salts

5 Which organ system is shown in the diagram?

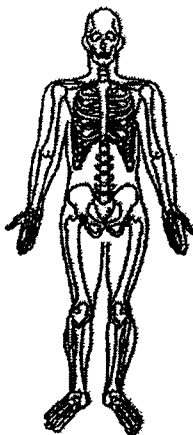

- (1) skeletal system
- (2) digestive system
- (3) circulatory system
- (4) respiratory system

6 In which part of the digestive system is food absorbed into the blood?

- (1) gullet
- (2) mouth
- (3) stomach
- (4) small intestine

(Go on to the next page)

7 Which of the following is a source of light?

(1)



a banana

(2)



a campfire

(3)



a mirror

(4)



human eyes

8 The diagram shows a frying pan.

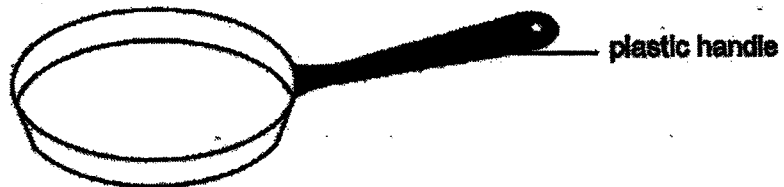

Mrs Lee is able to hold the plastic handle while cooking on a hot stove. This is because plastic is a _____.

- (1) flexible material
- (2) waterproof material
- (3) poor conductor of heat
- (4) good conductor of heat

(Go on to the next page)

- 9 The diagram shows the life cycle of a plant.

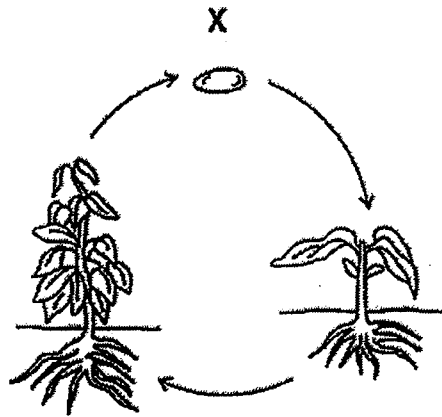

What is the stage marked X?

- (1) egg
 - (2) seed
 - (3) adult plant
 - (4) young plant
- 10 Which animal has a nymph as a stage in its life cycle?
- (1) beetle
 - (2) butterfly
 - (3) mosquito
 - (4) cockroach

(Go on to the next page)

- 11 James wanted to find out if the number of coils of wire around a nail affects the strength of an electromagnet. He has set-ups W, X, Y and Z as shown.

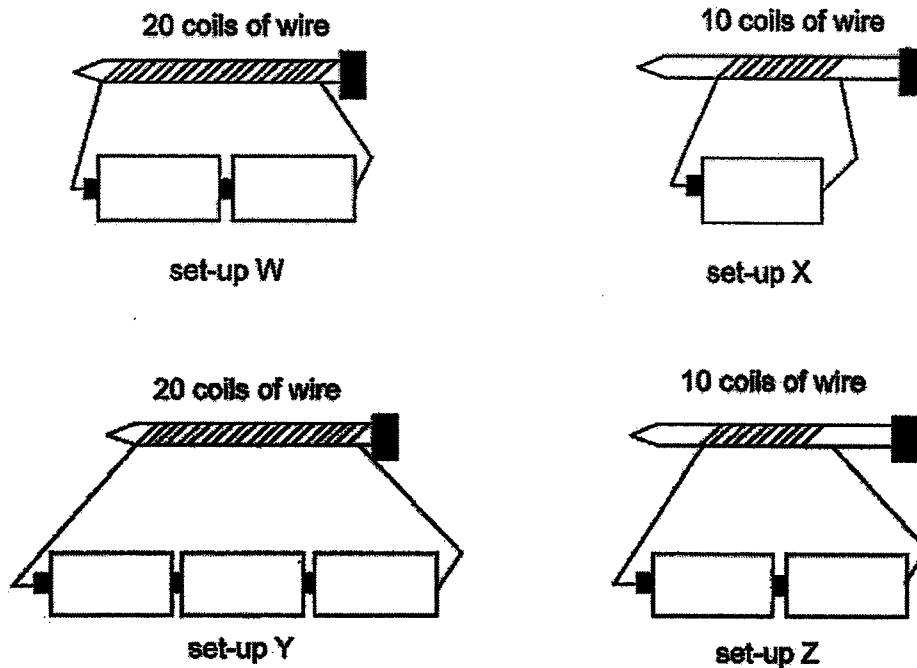

Which of the following set-ups should he use to ensure a fair test?

- (1) Set-ups W and X
 - (2) Set-ups X and Z
 - (3) Set-ups X and Y
 - (4) Set-ups W and Z
- 12 A piece of magnet was broken into two pieces of magnet. 'N' represents the North pole.



Which of the following correctly shows the poles of X and Y?

	X	Y
(1)	North	South
(2)	South	North
(3)	South	South
(4)	North	North

(Go on to the next page)

- 13 When Peter stood in front of a wall as shown, he could not see the pot of plant.

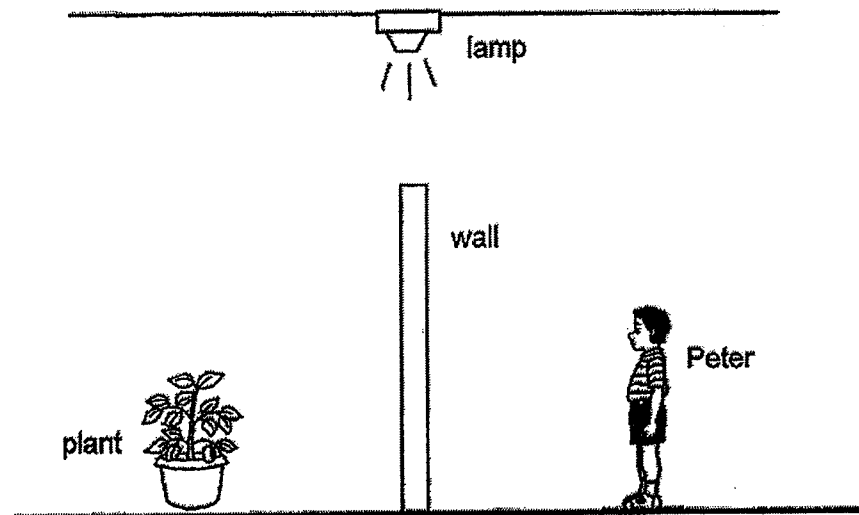

Which of the following explains why he could not see the plant?

- (1) The wall did not reflect light.
- (2) The plant did not reflect light.
- (3) The wall did not allow light to pass through.
- (4) The plant did not allow light to pass through.

(Go on to the next page)

- 14 The diagram shows the shadows of a wooden block formed at different times of a day. The sun rises in the east and sets in the west.

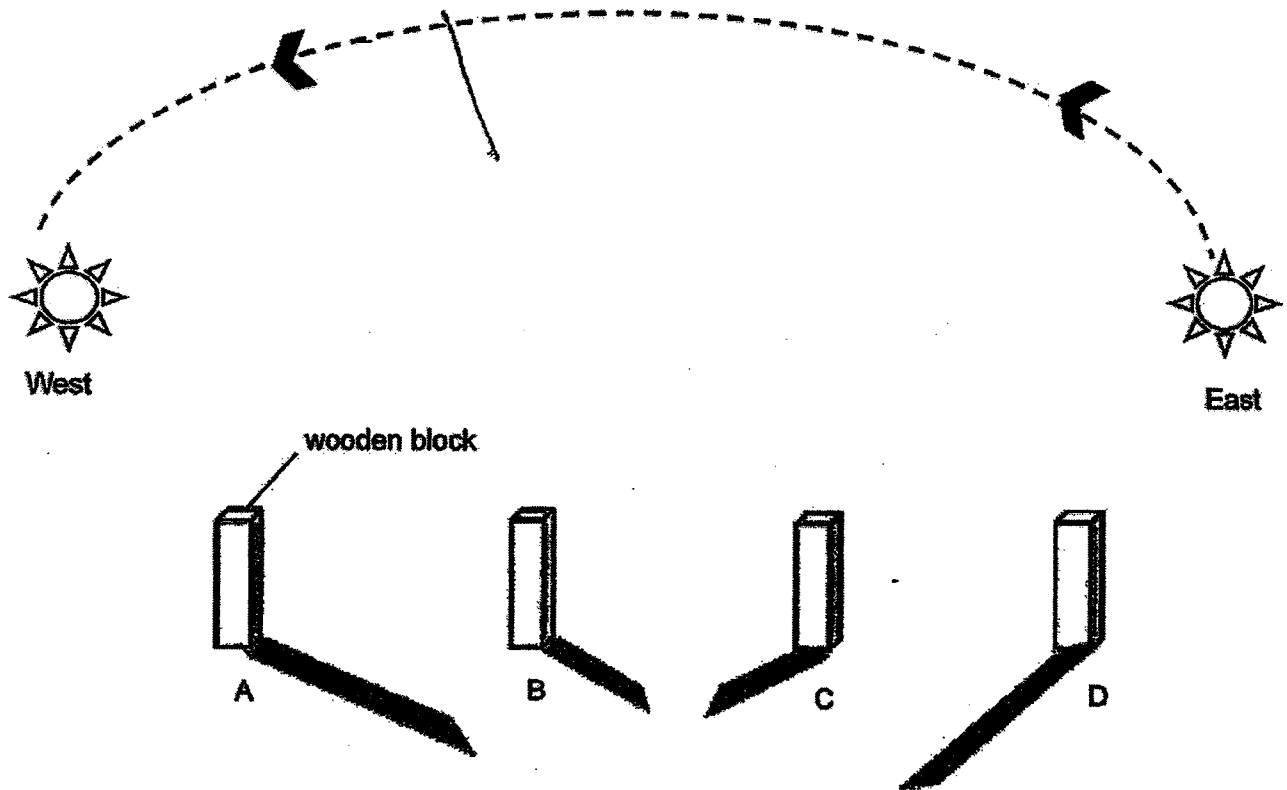

Which of the following is likely to be the shadow formed at 2 o'clock in the afternoon?

- (1) A
- (2) B
- (3) C
- (4) D

(Go on to the next page)

- 15 The diagram shows a magnifying glass.



Which of the following is/are possible shadow(s) formed by the magnifying glass?



A



B



C



D

- (1) C only
(2) A and B only
(3) B and D only
(4) C and D only

(Go on to the next page)

- 16 An experiment was set up in a dark room using a torch, a cardboard with a triangular cut-out and three different sheets E, F and G.

Property of sheet	Sheet
Does not allow light to pass through	E and F
Allows all light to pass through	G

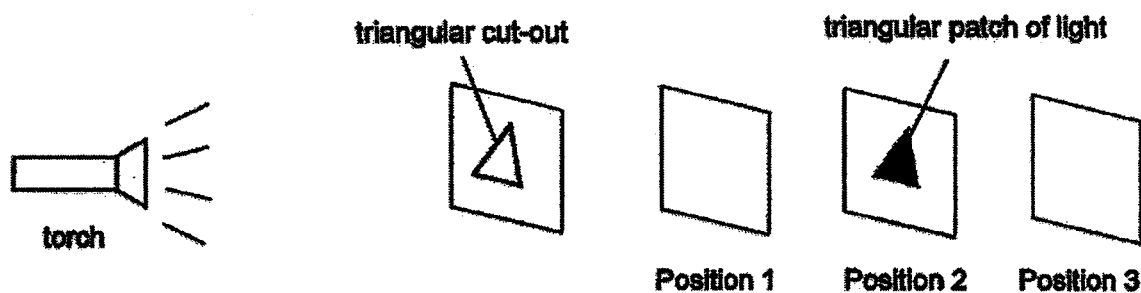

How should the sheets be arranged so that a triangular patch of light is seen at position 2?

	Position 1	Position 2	Position 3
(1)	G	F	E
(2)	E	G	F
(3)	F	G	E
(4)	E	F	G

(Go on to the next page)

- 17 The diagram shows a square metal frame. Four similar drops of wax were attached at positions W, X, Y and Z.

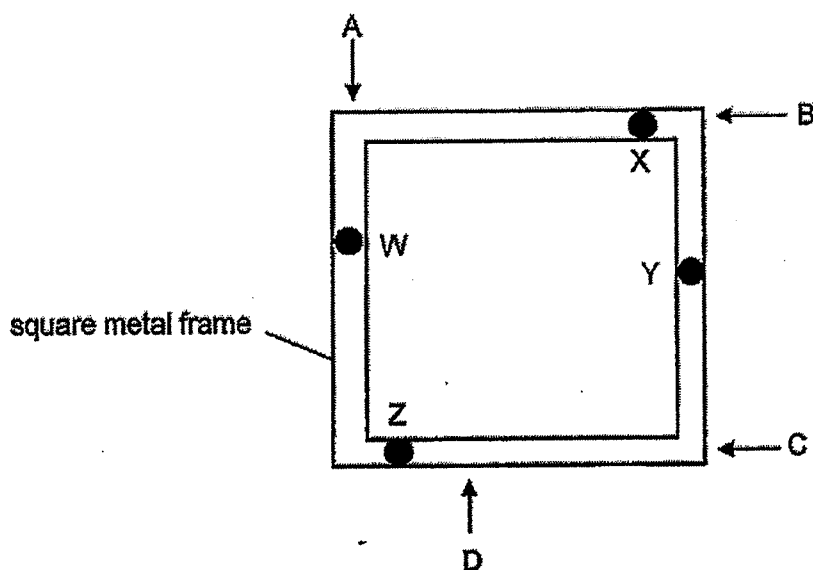

Kim heated the metal frame at one of the points A, B, C or D and recorded the time taken for the wax to melt as shown in the table.

Position of wax	Time taken for the drop of wax to melt (minutes)
W	5
X	10
Y	7
Z	1

Based on the results, at which point was the metal frame heated?

- (1) A
- (2) B
- (3) C
- (4) D

(Go on to the next page)

- 18 Ring Y and rod X are made of metal. Both were stuck together as shown in the diagram.

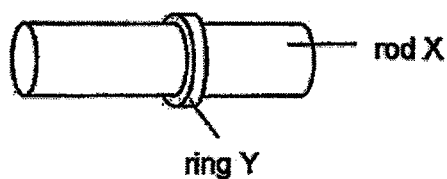

Which of the following is the best way to separate the ring and the rod?

- (1) Heat only rod X over a flame.
 - (2) Heat only ring Y over a flame.
 - (3) Place both ring Y and rod X in hot water.
 - (4) Place both ring Y and rod X in cold water.
- 19 The diagram shows a boy pumping more air into a fully inflated soccer ball.

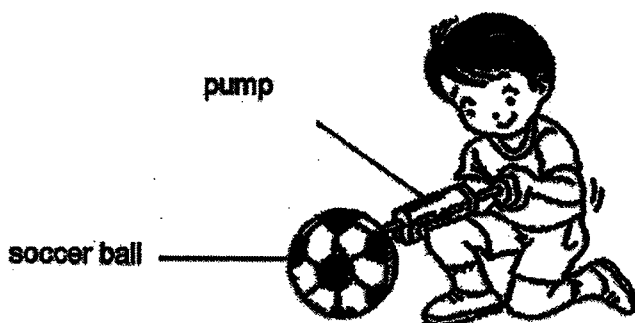

How will the mass and volume of the ball change?

	Mass	Volume
(1)	Increase	Decrease
(2)	Increase	No change
(3)	No change	Increase
(4)	No change	No change

(Go on to the next page)

- 20 The diagram shows a metal key.



metal key

What can be used to measure the mass and volume of the key?

	Mass of key	Volume of key
(1)	ruler	beaker filled with some water
(2)	electronic balance	measuring cylinder filled with some water
(3)	measuring cylinder filled with some water	electronic balance
(4)	electronic balance	data logger with a heat sensor

- 21 The diagram shows a pump fitted to a container with a capacity of 300 cm^3 .

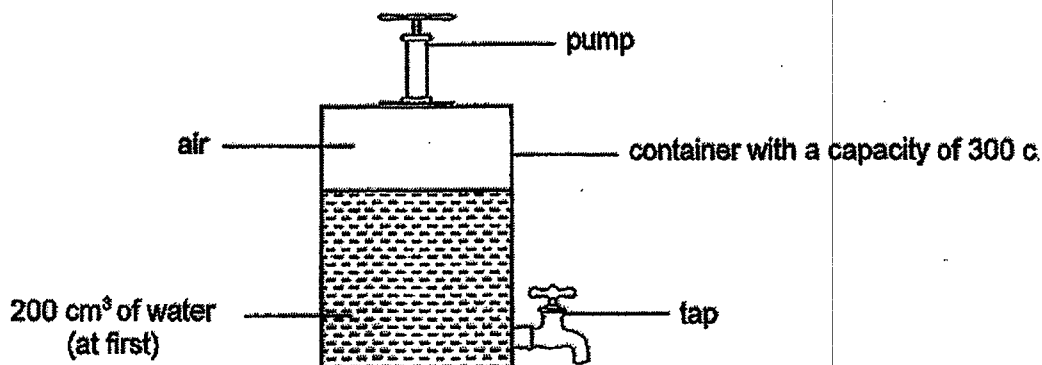

The container has 200 cm^3 of water at first. 40 cm^3 of water flowed out of the tap, and 20 cm^3 of air was then pumped in.

What was the final volume of air in the container?

- (1) 20 cm^3
- (2) 140 cm^3
- (3) 180 cm^3
- (4) 280 cm^3

(Go on to the next page)

22 Study the flow chart.

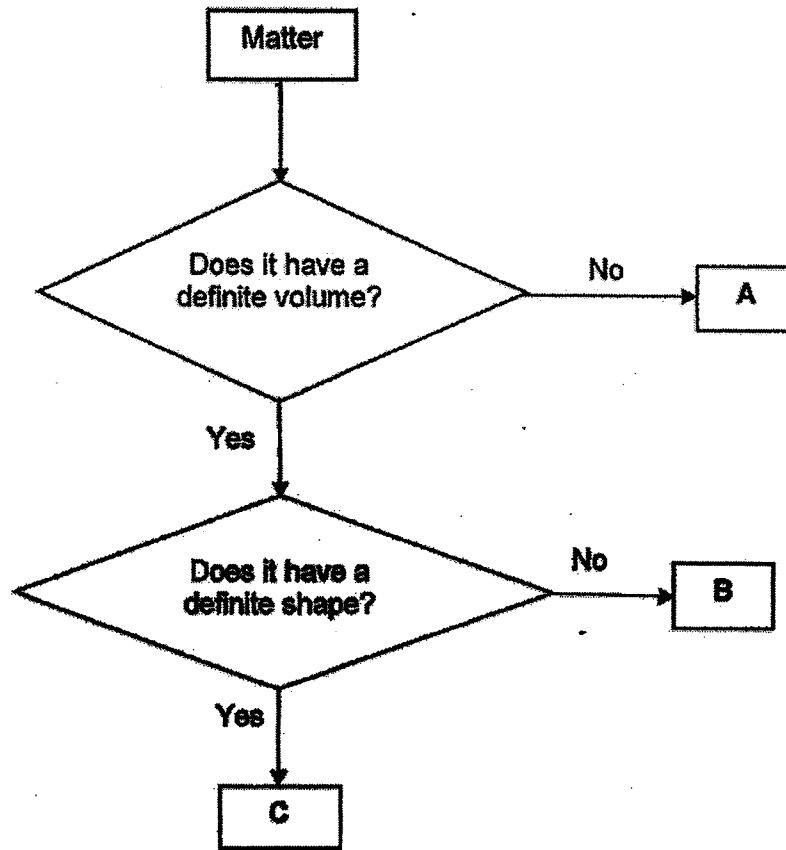

Which of the following could A, B and C be?

	A	B	C
(1)	air	grain of sand	pencil
(2)	milk	air	grain of sand
(3)	air	milk	grain of sand
(4)	grain of sand	air	pencil

(Go on to the next page)

23 Sulin listed some conditions as shown.

- A: air
- B: water
- C: warmth
- D: sunlight

Which of the following shows the conditions that are needed for a seed to germinate?

- (1) A and D only
- (2) B and C only
- (3) A, B and C only
- (4) A, B, C and D

24 Study the diagram of the young plant.

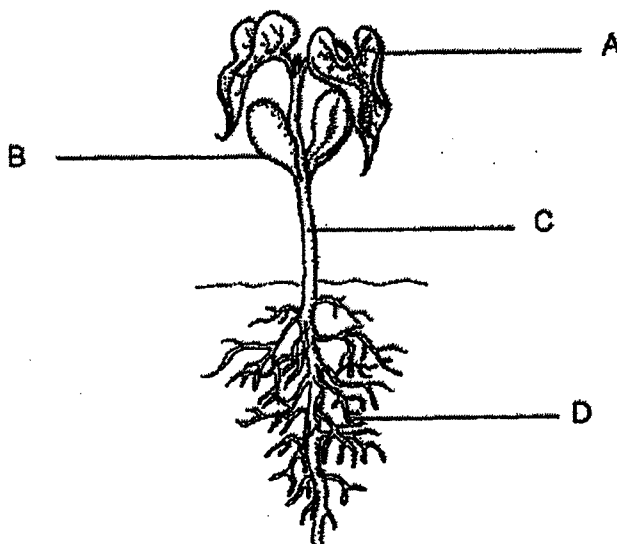

Which part, A, B, C or D, will become smaller as the plant develops healthily?

- (1) A
- (2) B
- (3) C
- (4) D

(Go on to the next page)

25 Study the classification chart.

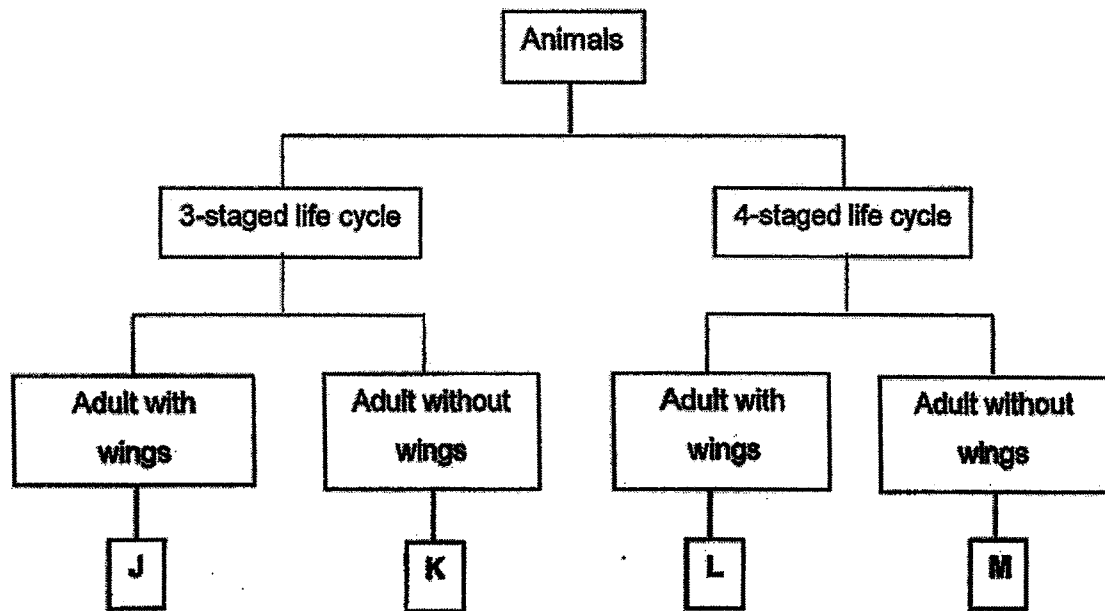

The diagram below shows the life cycle of animal R.

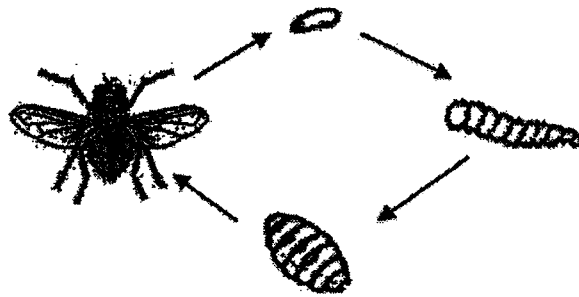

Based on the classification chart, which group best represents animal R?

- (1) J
- (2) K
- (3) L
- (4) M

(Go on to the next page)

26 The diagram shows the life cycle of animal W.

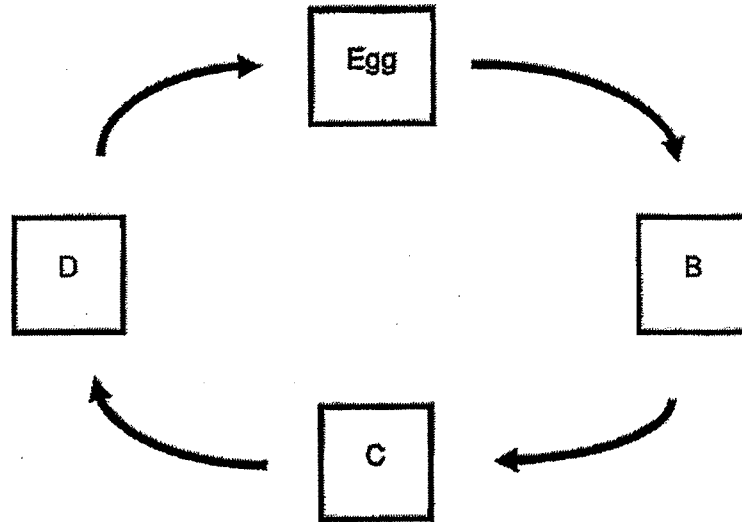

Which of the following graphs best represents the amount of food eaten by animal W at different stages of its life cycle?

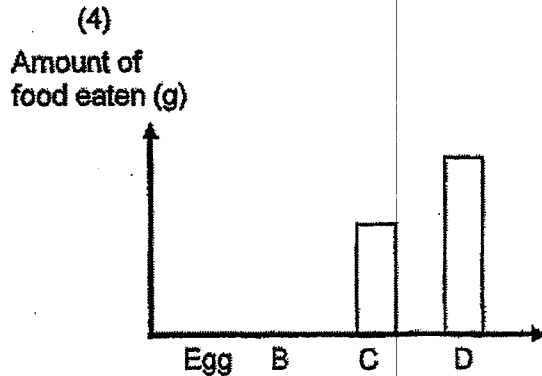
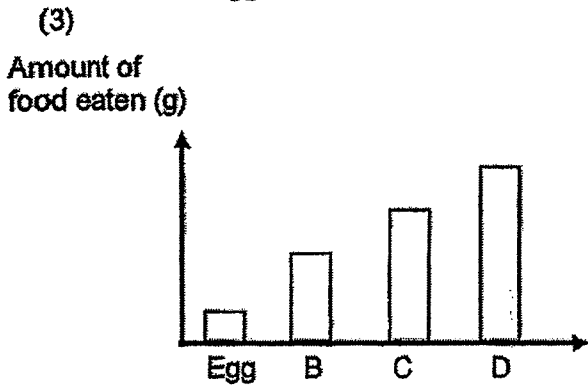
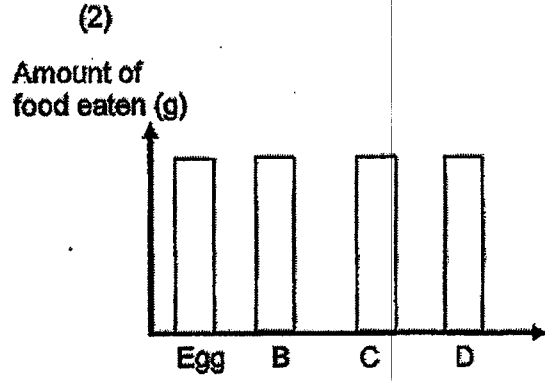
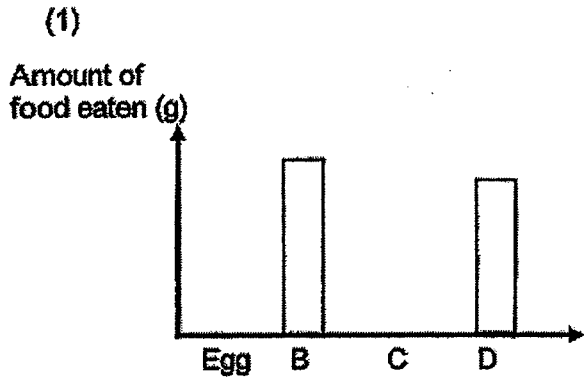

(Go on to the next page)

27. Jerry recorded his observations about the stages of the life cycle of animal Z.

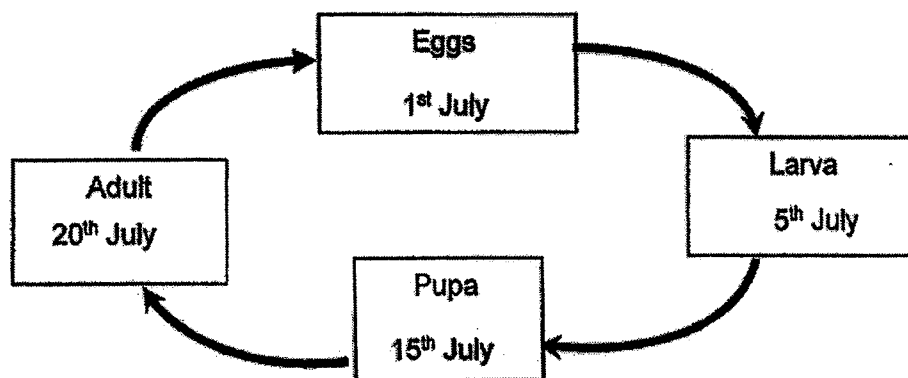

From the information above, which of the statements about animal Z is correct?

- (1) Adult animal Z lives in water.
- (2) It has three stages in its life cycle.
- (3) The entire life cycle is more than 14 days.
- (4) It stays as a larva for fewer days than it stays as a pupa.

28. Study the classification chart.

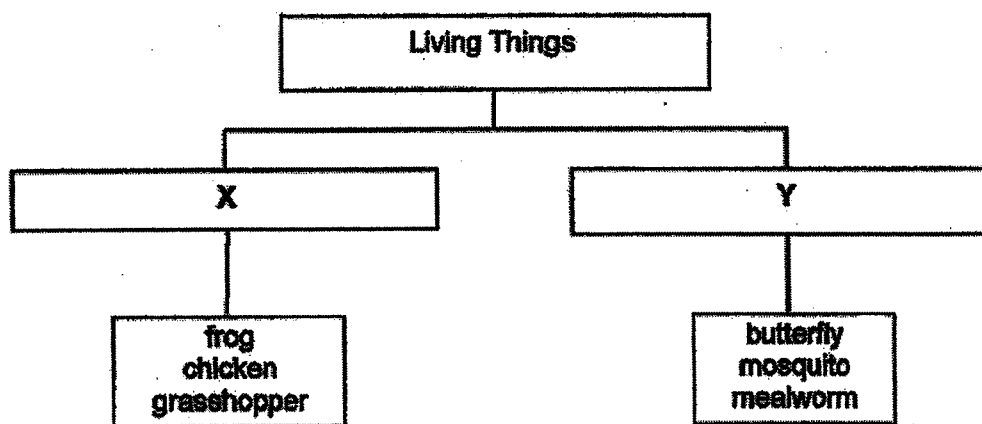

Which of the following characteristics is used to classify the living things?

- (1) How they reproduce
- (2) Type of food they eat
- (3) Number of days in their life cycles
- (4) Number of stages in their life cycles

End of Booklet A
Please go on to booklet B



Anglo-Chinese School
(Primary)

A Methodist Institution
(Founded 1886)

SEMESTRAL ASSESSMENT TWO 2022
SCIENCE
PRIMARY FOUR
BOOKLET B

Name: _____ ()

Class: Primary 4 ____

Date: 28 Oct 2022

Duration of paper: 1 h 45 min

Parent's/Guardian's signature

INSTRUCTIONS TO CANDIDATES

1. Write your name, index number and class in the spaces provided.
2. Do not turn this page until you are told to do so.
3. Follow all instructions carefully.
4. Answer all questions.
5. Write your answers in this booklet.

BOOKLET	MAX MARKS	MARKS OBTAINED
A	56	
B	44	
Total	100	

This question paper consists of 14 printed pages including this cover page.

For questions 29 to 41, write your answers in the spaces provided in this booklet.
The number of marks available is shown in brackets [] at the end of each question or part question.
(44 marks)

29 Classify the following living things into animals and plants.

[2]

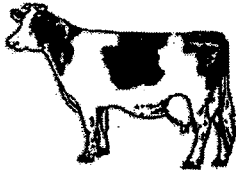

cow



banana tree

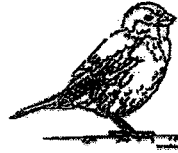

sparrow



fern

animals	plants

30 Jane placed a magnet near Rod A. Rod A moves towards the magnet.



(a) The magnet exerts a _____ on Rod A. [1]

(b) Choose the correct word from the box to answer the question below.

magnetic	non-magnetic	strong
----------	--------------	--------

Jane's observation shows that Rod A is made of a _____ material. [1]

(Go on to the next page)

Score	4
-------	---

- 31 Ahmad placed a wooden rod and a metal rod into a container of boiling water as shown. Equal amounts of wax were put on both rods.

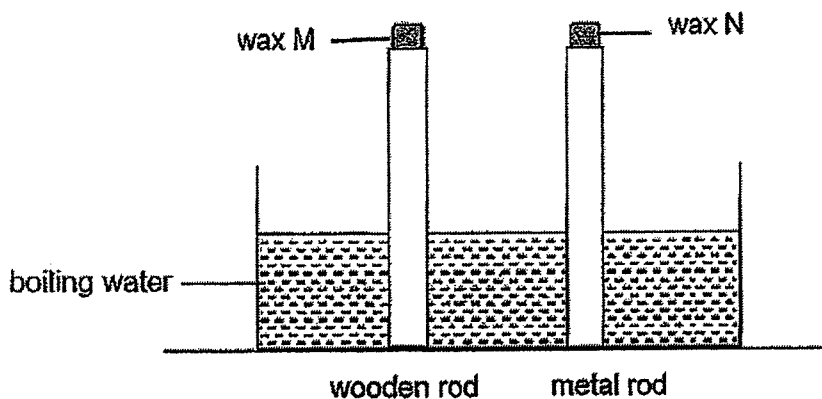

What would he observe and why? Fill in the blanks.

[2]

- (a) Wax _____ will melt first.
- (b) Metal is a _____ conductor of heat than wood.

Ahmad wanted to measure the temperature of the water and used the instrument as shown.

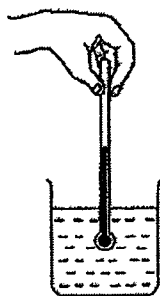

- (c) What is the instrument called?

[1]

(Go on to the next page)

Score	3
-------	---

32 The diagram below shows the young and adult of some organisms. Draw lines to match the young with the correct adult. [3]

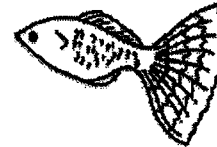
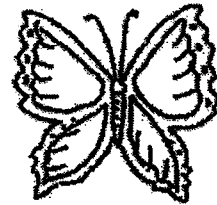

(Go on to the next page)

Score	3
-------	---

33 Daniel used a data logger to measure how much light can pass through materials W, X, and Y of similar size.

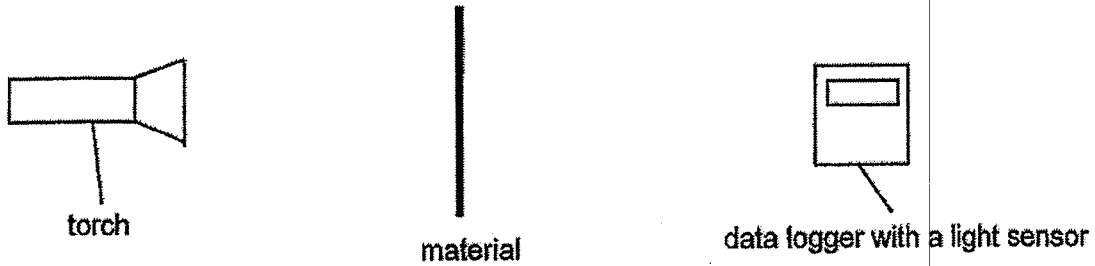

He recorded the results as shown.

Material	W	X	Y
Data logger reading (units)	80	0	30

(a) Based on the results above, complete the table below by writing W, X or Y. [2]

Property	Material
Allows some light to pass through	
Allows most light to pass through	

(b) Daniel put a screen between material X and the datalogger as shown below.

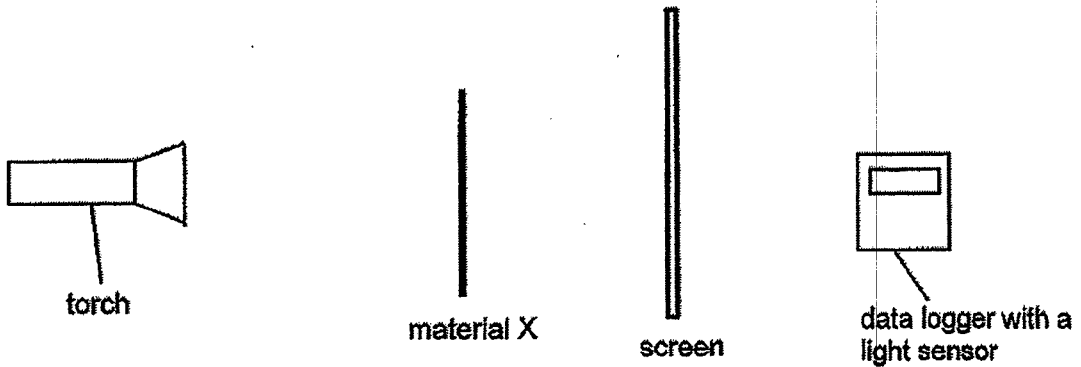

He observed a dark shadow formed by material X. State the property of light and the property of material X that caused the shadow to be formed. [2]

i) Property of light

ii) Property of material X

(Go on to the next page)

Score	4
-------	---

34 Sue conducted an experiment as shown.

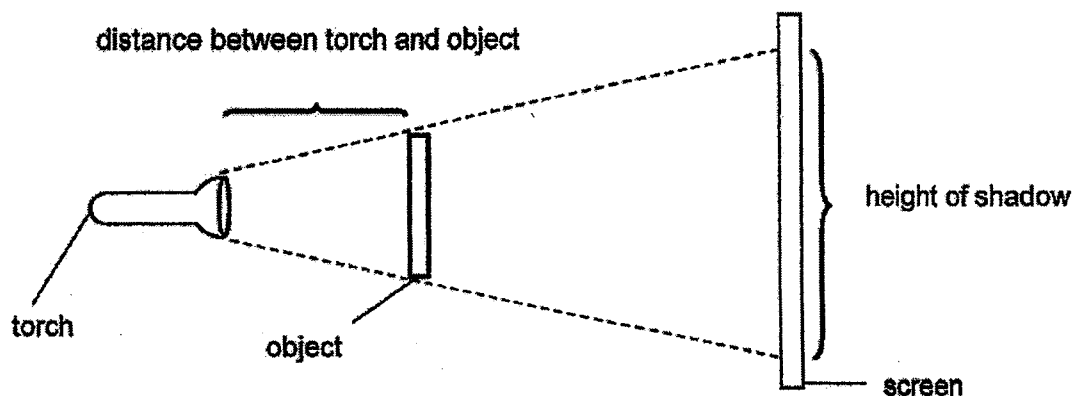

The results of her experiment are shown.

Distance between torch and object (cm)	Height of shadow on screen (cm)
5	15
10	a)
15	11
20	7

- (a) Predict the height of the shadow formed on the screen when the distance between the torch and the object was 10 cm. Write your answer in the table above. [1]
- (b) Based on the results, state the relationship between the distance of the torch and object, and the height of shadow formed on the screen. [1]

(Go on to the next page)

Score	2
-------	---

- 35 Peter heated three different solids, X, Y and Z with the same amount of heat and recorded the results as shown in the table.

Solid	Length of solid (cm)	
	Before heating	After heating
X	10	15
Y	10	12
Z	10	18

- (a) Based on the results, what happened to the length of solids X, Y and Z after they were heated? [1]

- (b) Explain your answer in part (a) above. [1]

Peter noticed that telephone wires were hung loosely across the poles on the roads.

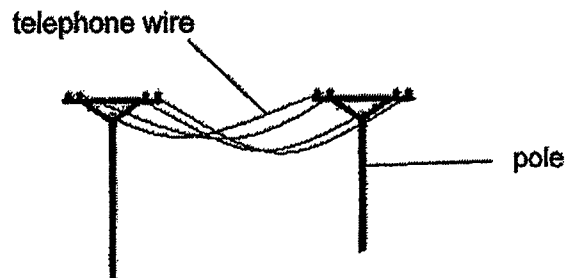

- (c) On a very cold night, what could happen to the telephone wires? [1]

- (d) Explain your answer in part (c) above. [1]

(Go on to the next page)

Score	4
-------	---

- 36 Mr Lim filled a flask with water at $100\text{ }^{\circ}\text{C}$ and then placed it into a basin which contained water at $12\text{ }^{\circ}\text{C}$ as shown below. He left the set-up on a table in a room. The room temperature was $28\text{ }^{\circ}\text{C}$.

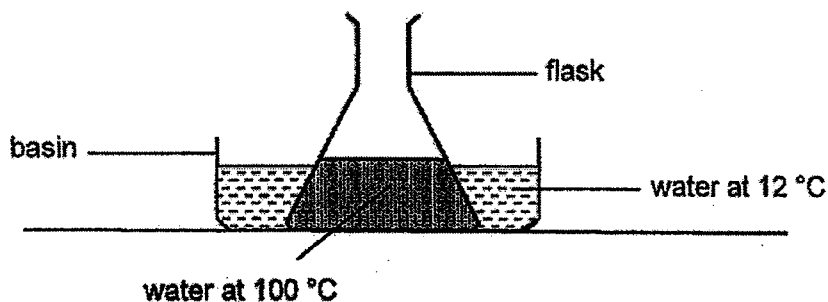

- (a) What will happen to the temperature of water in the flask after 10 minutes? [1]

- (b) Explain your answer in part (a) above. [1]

- (c) What is the temperature of water in the basin after 24 hours? [1]

_____ $^{\circ}\text{C}$

(Go on to the next page)

Score	3
-------	---

- 37 Sulin conducted an experiment using two similar containers A and B, each fitted with a funnel. A straw was inserted in container B. Next, she poured the same amount of water into each funnel at the same time.

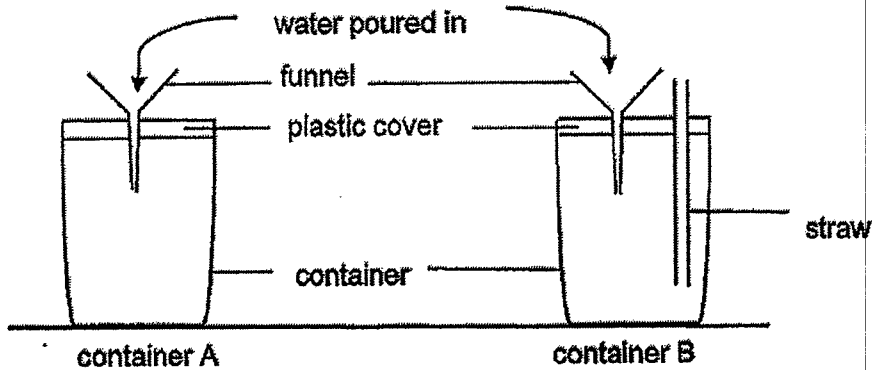

She observed that the water flowed into container B faster than into container A. She repeated the experiment three times and observed the same results.

- (a) Why did Sulin repeat the experiment three times? [1]

- (b) Explain why water flowed into container B faster. [2]

Sulin lifted the funnel of container A and poured water into the funnel as shown below.

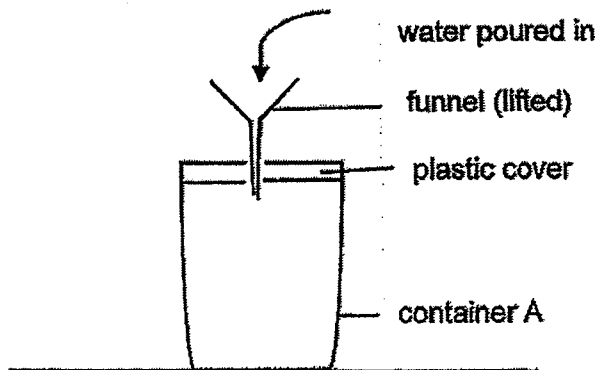

Fill in the blank with the correct word.

- (c) Water now flowed into container A _____ (faster / slower) [1]

(Go on to the next page)

Score	4
-------	---

- 38 Edward has a container which was separated by a stopper. The left part was filled with substance M. When he pulled the stopper up, substance M occupied some space in the container as shown.

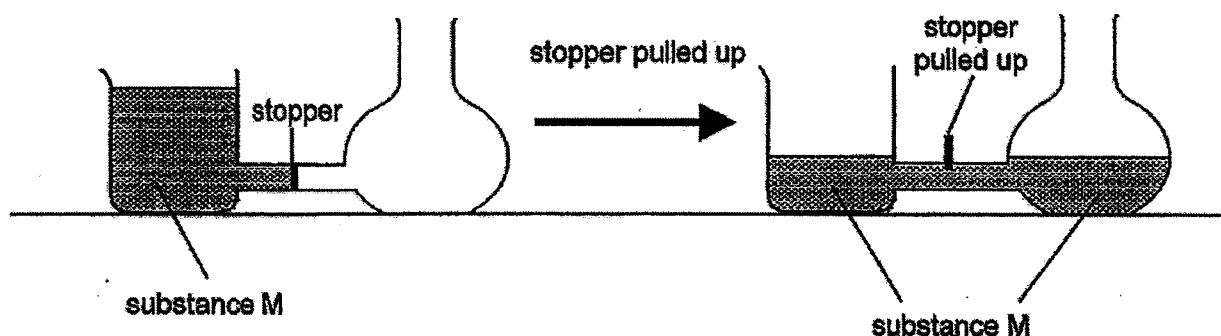

- (a) What is the state of matter of substance M? [1]

- (b) State the property of substance M that causes it to occupy the space in the container after the stopper was pulled up. [1]

Edward then filled another container to the brim with 80 cm^3 of water. After that, he gently lowered a marble with a volume of 10 cm^3 into the container. He observed that some water flowed out of the container as shown.

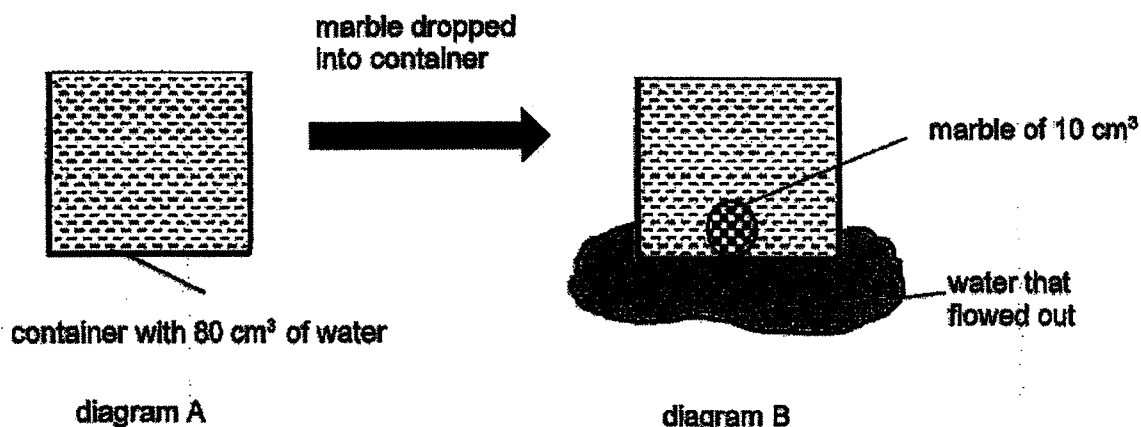

(Go on to the next page)

Score	2
-------	---

(c) Refer to diagram B and complete the table.

[2]

Description	Amount of water (cm ³)
Amount of water that flowed out	
Amount of water in the container after marble was lowered	

(d) In the table below, put a tick (✓) to show the property of the marble that best explains why the water flowed out. Tick 1 box only.

[1]

Property	Tick (✓) one box only
The marble has mass.	
The marble occupies space.	
The marble has a fixed shape.	

(Go on to the next page)

Score	3
-------	---

- 39 Adrian planted a seed on some cotton wool and left it near an open window. He watered it daily and recorded the length of its root and shoot in the table.

Day	Part X (mm)	Part Y (mm)
1	0	0
2	0	1
3	0	3
4	2	5
5	4	8
6	7	11

- (a) Based on the information in the table, which part, X or Y, is the root? [1]

- (b) Give a reason for your answer in part (a) above. [1]

Adrian saw a tree in his garden.

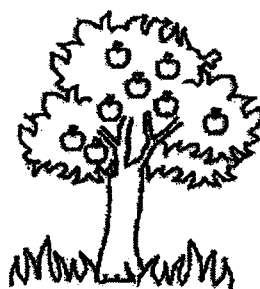

tree

- (c) Based on the picture above, which stage of its life cycle is the tree at? [1]

- (d) Explain your answer in part (c) above. [1]

(Go on to the next page)

Score	4
-------	---

- 40 The table below shows the characteristics of three animals, X, Y and Z.

Characteristics	Animal		
	X	Y	Z
The adult has three body parts.	No	Yes	No
The adult reproduces by laying eggs.	No	Yes	Yes
The young looks like the adult.	Yes	Yes	No
The adult can fly.	No	Yes	No

- (a) Based on the table above, state one similarity between animal X and animal Y. [1]

- (b) Based on the table above, state two differences between animal X and animal Z. [2]

(i)

(ii)

- (c) Bala concluded that animal Y is a butterfly. Based on the characteristics in the table above, is his conclusion correct? Give a reason for your answer. [1]

- (d) Why do living things need to reproduce? [1]

(Go on to the next page)

Score	5
-------	---

- 41 Clara wanted to find out the most suitable temperature for the eggs of animal Q to hatch. She had six enclosed boxes set at different temperatures. She placed eight eggs of animal Q in each box. After two weeks, she counted the number of eggs that hatched and recorded the results in the table.

Temperature of box (°C)	Number of eggs hatched
31	0
33	2
35	6
37	8
39	2
41	0

- (a) Based on the results above, at what temperature did most eggs hatch? [1]

_____ °C

- (b) For each variable below, put a tick (✓) in the correct column to show if Clara should keep the variable the same or change the variable. [2]

	Variable	Keep variable the same	Change the variable
(i)	Type of eggs		
(ii)	Number of eggs		
(iii)	Material of boxes		
(iv)	Temperature of boxes		

End of Booklet B / End of Paper

Score	3
-------	---

Name: _____ ()

Class: _____

P4 SA2 Science Examination 2022
Students' Corrections Template

Booklet A

No	Ans	No	Ans	No	Ans	No	Ans	No	Ans	No	Ans
1	2	6	4	11	4	16	1	21	2	26	1
2	4	7	2	12	2	17	4	22	3	27	3
3	3	8	3	13	3	18	2	23	3	28	4
4	1	9	2	14	2	19	2	24	2		
5	1	10	4	15	4	20	2	25	3		

Booklet B

Qn	Suggested Answers							
29	Animals: cow, sparrow	Plants: banana tree, fern						
30 (a)	The magnet exerts a <u>pull</u> on Rod A							
(b)	Jane's observation shows that Rod A is made of a <u>magnetic</u> material.							
31 (a)	Wax <u>N</u> will melt first.							
(b)	Metal is a <u>better</u> conductor of heat than wood.							
(c)	thermometer							
32								
33 (a)	<table border="1"> <thead> <tr> <th>Property</th> <th>Material</th> </tr> </thead> <tbody> <tr> <td>Allows some light to pass through</td> <td><u>Y</u></td> </tr> <tr> <td>Allows most light to pass through</td> <td><u>W</u></td> </tr> </tbody> </table>	Property	Material	Allows some light to pass through	<u>Y</u>	Allows most light to pass through	<u>W</u>	
Property	Material							
Allows some light to pass through	<u>Y</u>							
Allows most light to pass through	<u>W</u>							
(b)(i)	Light travels in a <u>straight</u> line.							
(b)(ii)	Material X does not allow light to pass through.							
34 (a)	12 / 13 / 14							
(b)	When the distance between torch and object <u>increases</u> , the height of shadow <u>decreases</u> .							
35 (a)	The length increases.							

(b)	When solids are heated, they gain heat and <u>expand</u> .															
(c)	The wires will snap.															
(d)	On very cold nights, the wires will lose heat to the <u>surroundings</u> and <u>contract</u> .															
36 (a)	The temperature <u>decreases</u> .															
(b)	Water in the flask <u>loses</u> heat to the cooler water in the basin and the surroundings.															
(c)	<u>28 °C</u>															
37 (a)	To ensure that the results are <u>reliable</u> .															
(b)	The air in container B could <u>escape</u> through the inserted straw. Hence, water could enter container B faster, <u>taking up</u> the space of the air that has escaped.															
(c)	faster															
38 (a)	Liquid															
(b)	Substance M does not have a fixed / definite <u>shape</u> .															
(c)	<table border="1"> <thead> <tr> <th>Description</th> <th>Amount of water (cm³)</th> </tr> </thead> <tbody> <tr> <td>Amount of water that flowed out</td> <td>10</td> </tr> <tr> <td>Amount of water in the container after marble was lowered</td> <td>70</td> </tr> </tbody> </table>	Description	Amount of water (cm ³)	Amount of water that flowed out	10	Amount of water in the container after marble was lowered	70									
Description	Amount of water (cm ³)															
Amount of water that flowed out	10															
Amount of water in the container after marble was lowered	70															
(d)	<table border="1"> <thead> <tr> <th>Property</th> <th>Tick (✓) one box only</th> </tr> </thead> <tbody> <tr> <td>The marble has mass.</td> <td></td> </tr> <tr> <td>The marble occupies space.</td> <td>✓</td> </tr> <tr> <td>The marble has a fixed shape.</td> <td></td> </tr> </tbody> </table>	Property	Tick (✓) one box only	The marble has mass.		The marble occupies space.	✓	The marble has a fixed shape.								
Property	Tick (✓) one box only															
The marble has mass.																
The marble occupies space.	✓															
The marble has a fixed shape.																
39 (a)	Y															
(b)	<u>Roots</u> grow first.															
(c)	The plant is at its <u>adult</u> stage.															
(d)	Only adult plants bear <u>fruits</u> .															
40 (a)	Both the <u>young</u> of animals X and Y <u>look like</u> their adults.															
(b)(i),(ii)	Animal X does not reproduce by laying eggs but animal Z reproduces by laying eggs. The young of animal X looks like its adult but the young of animal Z does not look like its adult.															
(c)	No. The young of a butterfly does not look like its adult.															
(d)	To ensure the <u>continuity</u> of its own kind.															
41 (a)	<u>37 °C</u>															
(b)	<table border="1"> <thead> <tr> <th>Variable</th> <th>Keep variable the same</th> <th>Change the variable</th> </tr> </thead> <tbody> <tr> <td>Type of eggs</td> <td>✓</td> <td></td> </tr> <tr> <td>Number of eggs</td> <td>✓</td> <td></td> </tr> <tr> <td>Material of boxes</td> <td>✓</td> <td></td> </tr> <tr> <td>Temperature of boxes</td> <td></td> <td>✓</td> </tr> </tbody> </table>	Variable	Keep variable the same	Change the variable	Type of eggs	✓		Number of eggs	✓		Material of boxes	✓		Temperature of boxes		✓
Variable	Keep variable the same	Change the variable														
Type of eggs	✓															
Number of eggs	✓															
Material of boxes	✓															
Temperature of boxes		✓														