



**NAN HUA PRIMARY SCHOOL  
END-OF-YEAR EXAMINATION 2022  
PRIMARY 4**

**SCIENCE**

**BOOKLET A**

**28 Multiple Choice Questions (56 marks)**

**Total Time for Booklets A and B: 1 hour 45 minutes**

**INSTRUCTIONS TO CANDIDATES**

1. Write your name, index number and class in the spaces provided below.
2. Do not turn over the page until you are told to do so.
3. Follow all instructions carefully.
4. Answer all questions.
5. Use a 2B pencil to shade your answers on the Optical Answer Sheet (OAS).

**Marks Obtained**

<b>Booklet A</b>		/ 56
<b>Booklet B</b>		/ 44
<b>Total</b>		/ 100

**Name:** \_\_\_\_\_ (     )     **Class:** P 4S \_\_\_\_\_

**Date:** 27 October 2022

**Parent's Signature:** \_\_\_\_\_

---

This booklet consists of 25 printed pages.



**Section A: (28 x 2 marks = 56 marks)**

For each question from 1 to 28, four options are given. One of them is the correct answer. Make your choice (1, 2, 3 or 4). Shade the correct oval (1, 2, 3 or 4) on the Optical Answer Sheet.

- 1 The leaves of a mimosa plant will close when touched.

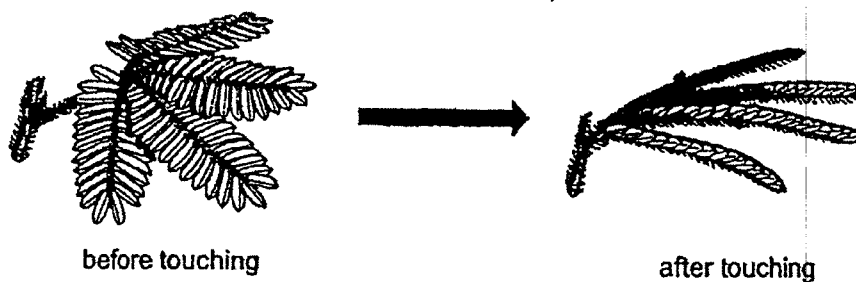

This shows that the mimosa is a living thing because it can \_\_\_\_\_.

- (1) grow
- (2) breathe
- (3) respond
- (4) reproduce

(Go on to the next page)

- 2 The diagram below shows a young plant.

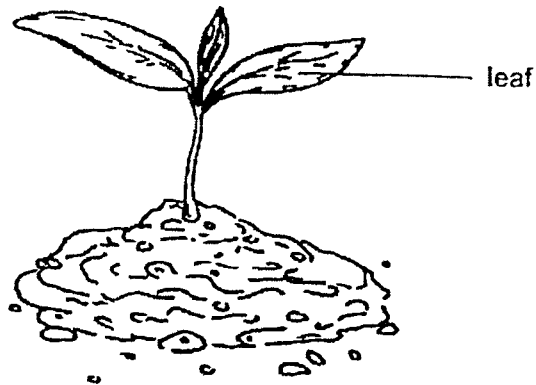

The leaf helps the plant to \_\_\_\_\_.

- (1) make food
  - (2) grow upright
  - (3) absorb water
  - (4) absorb nutrient
- 3 In which part of the human digestive system is water absorbed into the blood?
- (1) gullet
  - (2) stomach
  - (3) small intestine
  - (4) large intestine

(Go on to the next page)

- 4 The diagram shows the life cycle of a plant.

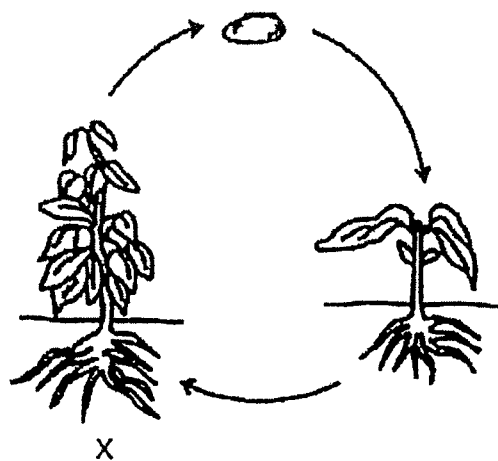

What is the stage marked X?

- (1) egg
- (2) seed
- (3) adult plant
- (4) young plant

(Go on to the next page)

- 5 The diagram shows a painting hanging on a wall.

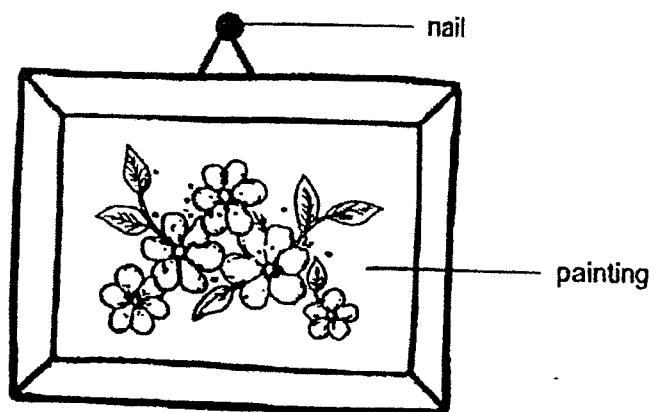

Iron is used to make nails because iron \_\_\_\_\_.

- (1) is shiny
- (2) is strong
- (3) sinks in water
- (4) conducts heat well

(Go on to the next page)

- 6 An object X was attracted to a U-shaped magnet, as shown in the figure below.

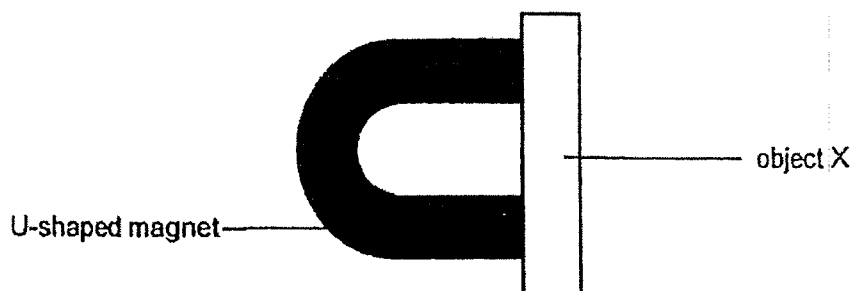

Object X is made of \_\_\_\_\_.

- (1) iron
  - (2) wood
  - (3) plastic
  - (4) rubber
- 7 Matter is anything that has mass and occupies space.

Which one of the following is not matter?

- (1) air
- (2) sand
- (3) music
- (4) water

(Go on to the next page)

- 8 The reading on the weighing scale shows that the mass of the oranges is \_\_\_\_\_ kg.

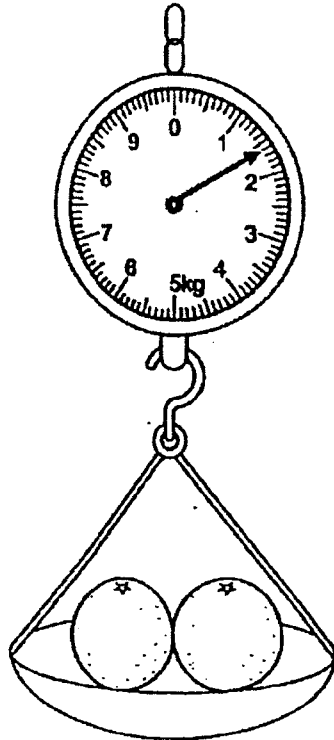

- (1) 1.4
- (2) 1.6
- (3) 2.4
- (4) 2.6

(Go on to the next page)



9 Look at the picture below.

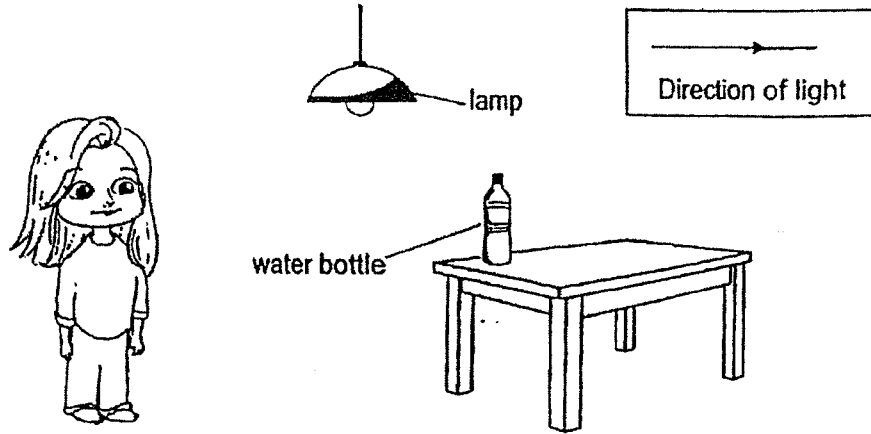

Which of the following explains why May was able to see her water bottle?

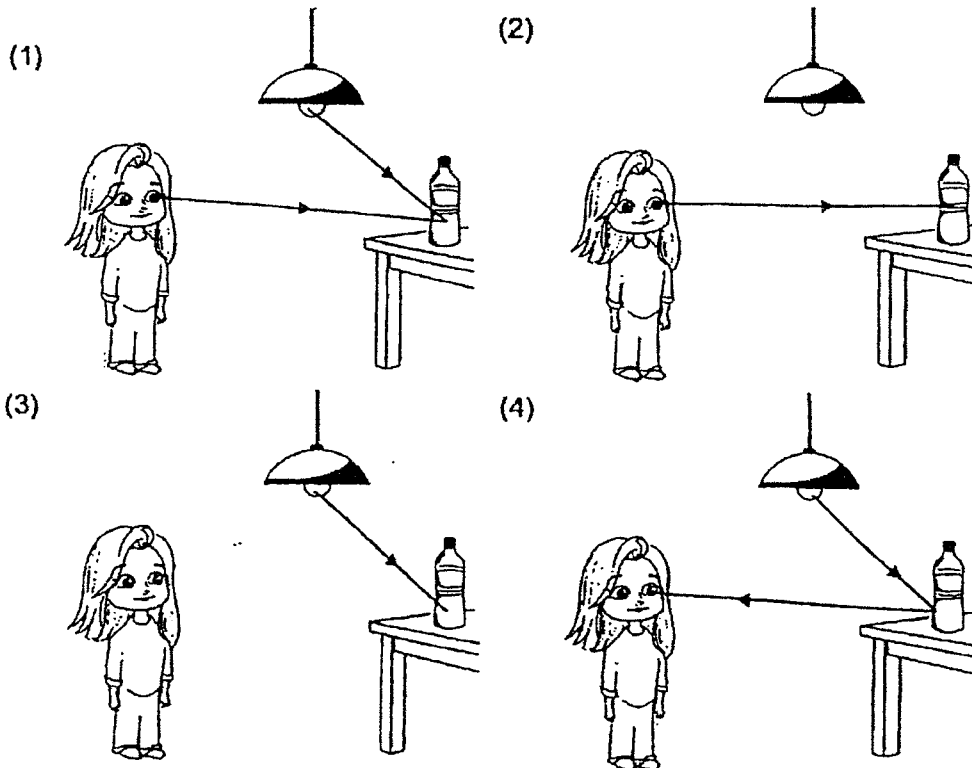

(Go on to the next page)

10 Which one of the following is not a source of heat?

- (1) The Sun
- (2) A lighted bulb
- (3) A woollen shirt
- (4) A candle flame

11 Jimmy wants to find out if organism A is an insect.

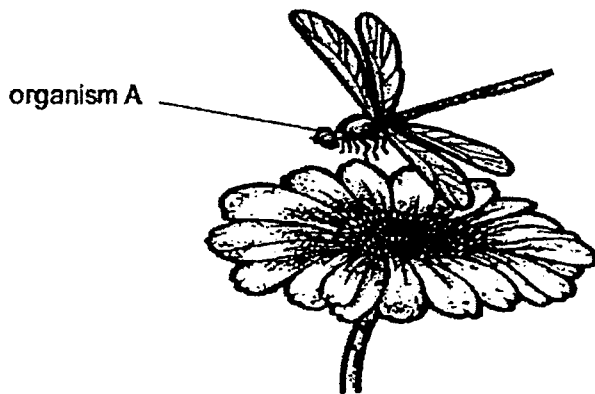

Which of the following characteristics will help Jimmy identify if organism A is an insect?

- (1) It can fly.
- (2) It has six legs.
- (3) It has huge eyes.
- (4) It has two pairs of wings.

(Go on to the next page)

12 Study the chart below.

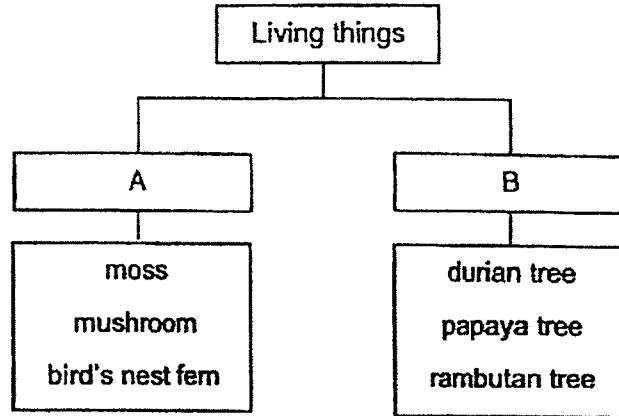

Which of the following best represents A and B correctly?

	A	B
(1)	fungi	plant
(2)	grow on land	grow in water
(3)	flowering plant	non-flowering plant
(4)	reproduce by spores	reproduce by seeds

(Go on to the next page)

13 Study the classification chart below.

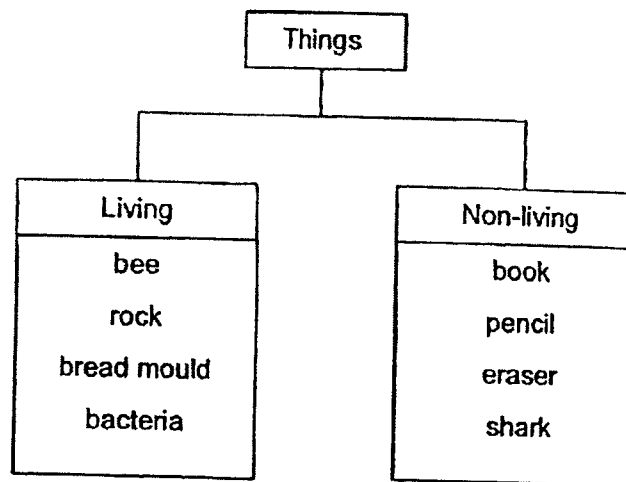

Which of the following have been placed in the wrong group?

- (1) bee and book
- (2) rock and shark
- (3) bacteria and eraser
- (4) bread mould and pencil

(Go on to the next page)

- 14 Amanda was gardening when she accidentally broke part of the stem at part Z as shown below. She observed that only the leaves originally growing above part Z had withered after a few days. The leaves below part Z remained healthy.

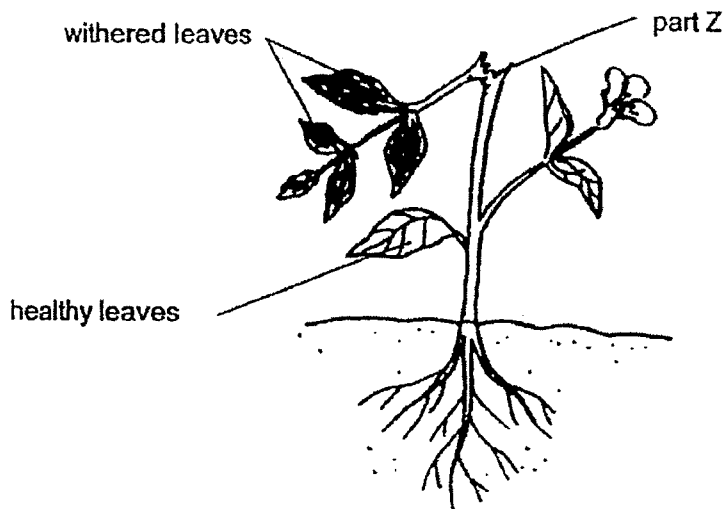

Which of the following statement best explains the observation she made?

- (1) Food could be transported to the leaves above part Z.
- (2) The leaves above part Z could not receive light to make food.
- (3) The leaves above part Z could not carry out gaseous exchange.
- (4) Water and mineral salts could not be transported to the leaves above part Z.

(Go on to the next page)

- 15 The table shows the different body systems and their functions.  
Which of the following incorrectly matches the function to the system?

	System	Function
(1)	skeletal	gives the body its shape
(2)	digestive	breaks down food into simple substances
(3)	circulatory	carries only digested food to all parts of the body
(4)	respiratory	enables gaseous exchange

- 16 A, B and C are organs in the digestive system. The graph below shows the amount of digested food found in the different organs.

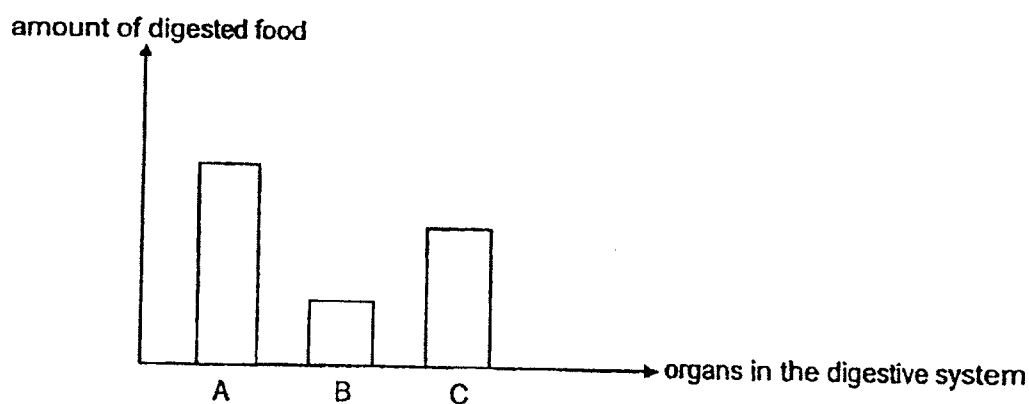

Which of the following correctly identifies organs A, B and C?

	Organ A	Organ B	Organ C
(1)	mouth	stomach	small intestine
(2)	mouth	small intestine	stomach
(3)	small intestine	mouth	stomach
(4)	small intestine	stomach	mouth

(Go on to the next page)

- 17 The diagram below shows the life cycle of organism X.

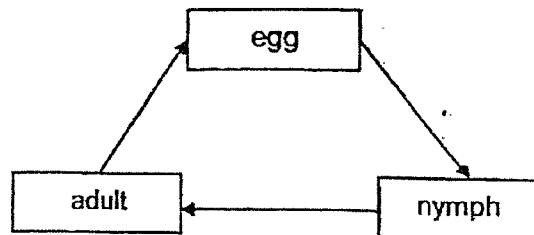

Which of the following could organism X be?

- (1) chicken
  - (2) butterfly
  - (3) mosquito
  - (4) cockroach
- 18 The graph below shows the number of days organism Y remains in each stage of its life cycle.

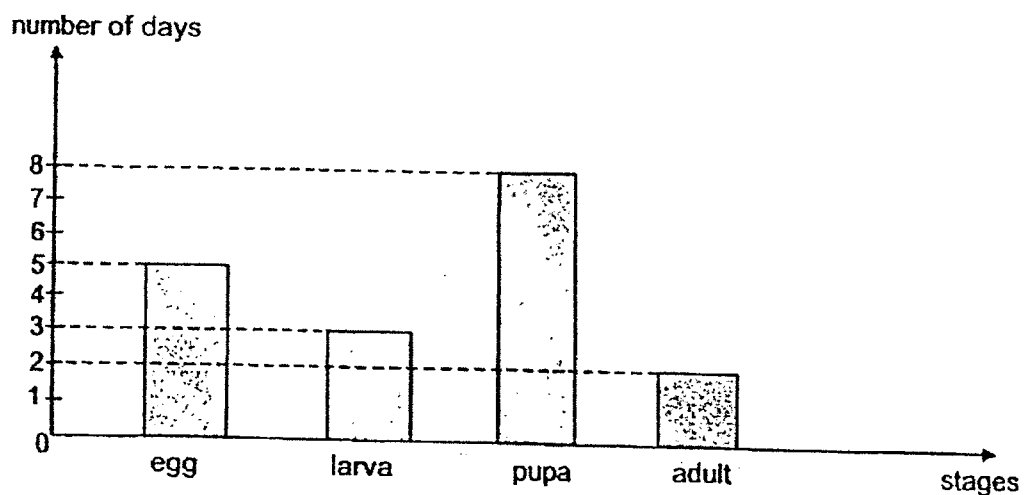

Which of the following is true about the life cycle of organism Y?

- (1) The organism laid 5 eggs only.
- (2) The organism took about 5 days to lay its eggs.
- (3) The organism stayed in the pupa stage for 8 days.
- (4) The organism spent 1 more day as an adult than as a larva.

(Go on to the next page)

- 19 Jessica wanted to make part Q of a hammock as shown below.

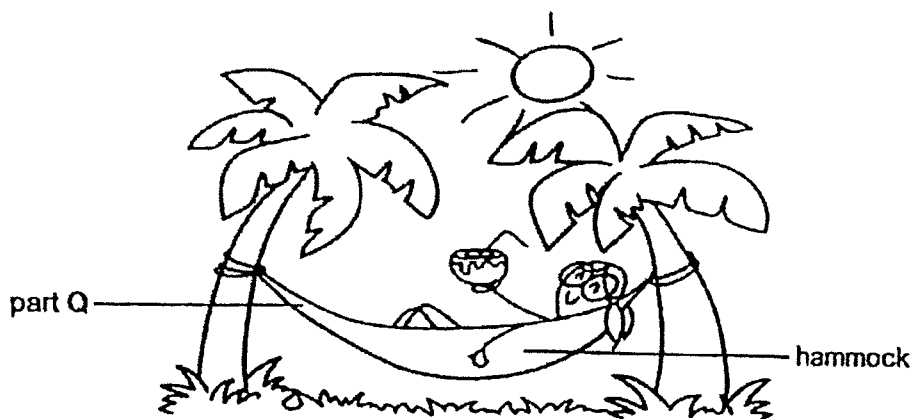

She carried out a few tests on materials, W, X, Y and Z and recorded their characteristics in the table below. A tick (✓) represents the presence of the characteristic in the material.

Material	Property		
	Flexible	Waterproof	Strong
W	✓	✓	
X	✓		✓
Y		✓	✓
Z	✓	✓	

Based on the information given in the table, which material was the most suitable for making part Q of the hammock?

- (1) Material W
- (2) Material X
- (3) Material Y
- (4) Material Z

(Go on to the next page)



20 Lucas classified some objects made of materials K, L, M and N, as shown below.

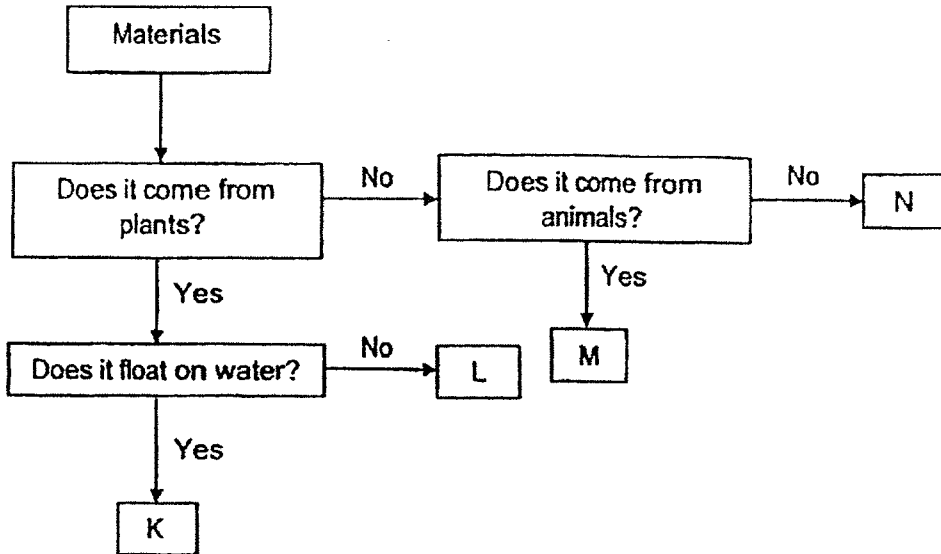

Which of the following correctly identifies the objects made of K, L, M and N?

Objects made of different material				
	K	L	M	N
(1)	rubber	cotton	leather	metal
(2)	cotton	rubber	leather	metal
(3)	metal	cotton	rubber	leather
(4)	metal	leather	rubber	cotton

(Go on to the next page)

- 21 Lillian set up an experiment as shown in the diagram below. She attached a wooden bar of mass 100 g to the left while an iron bar of mass 80 g on the right and observed that the beam balance was tilted downwards to the left initially.

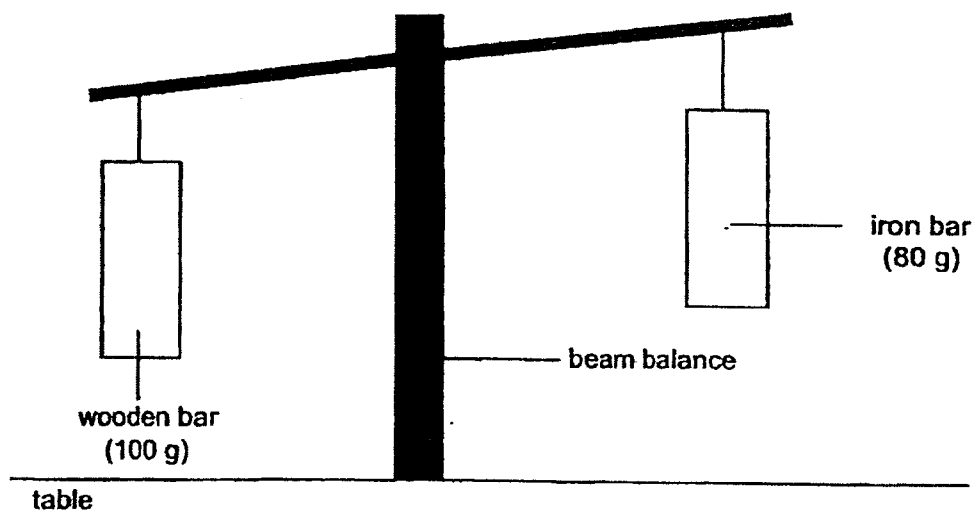

(Go on to the next page)

When she fixed a magnet to the table as shown in the diagram below, she realised the beam balance is now balanced.

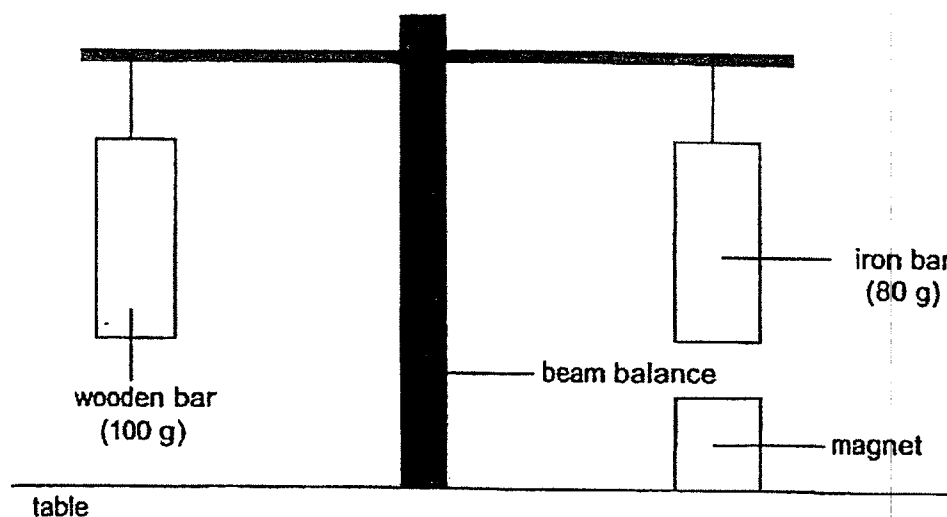

Which of the following statement explains how the beam balance is now balanced when the magnet is fixed to the table?

- (1) The magnet pushed the iron bar upwards as the iron bar is also a magnet.
- (2) The magnet pulled the iron bar downwards as the iron bar is also a magnet.
- (3) The magnet pushed the iron bar upwards as the iron bar is a magnetic material.
- (4) The magnet pulled the iron bar downwards as the iron bar is a magnetic material.

- 22 Jake carried out an investigation using identical batteries, iron rods and paper clips. He wanted to find out how the number of coils of wire around the iron rod will affect the strength of an electromagnet. The results of his tests are shown below.

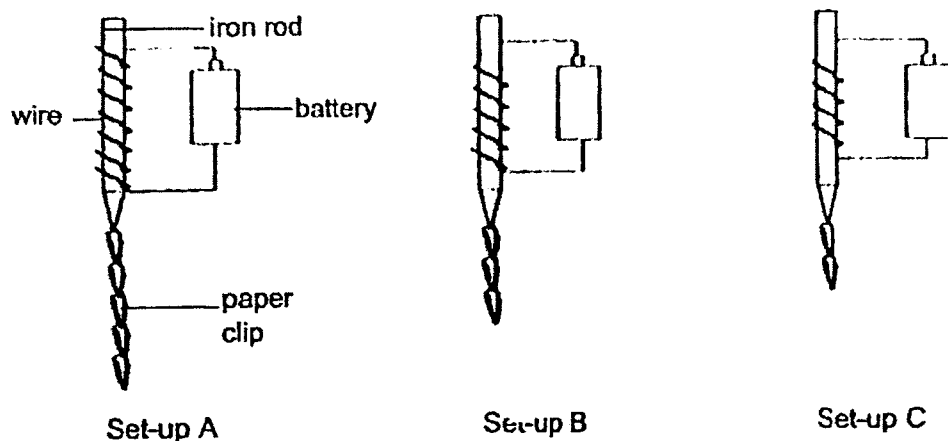

What could Jake conclude from the results of his tests?

- (1) The iron rods became permanent magnets.
- (2) The iron rod in set-up A had the strongest magnetic strength.
- (3) The iron rod in set-up A was as strong as the iron rod in set-up C.
- (4) The iron rod in set-up B had a weaker magnetic strength than in set-up C.

(Go on to the next page)

23 Study the flow chart which classifies objects R, S and T below.

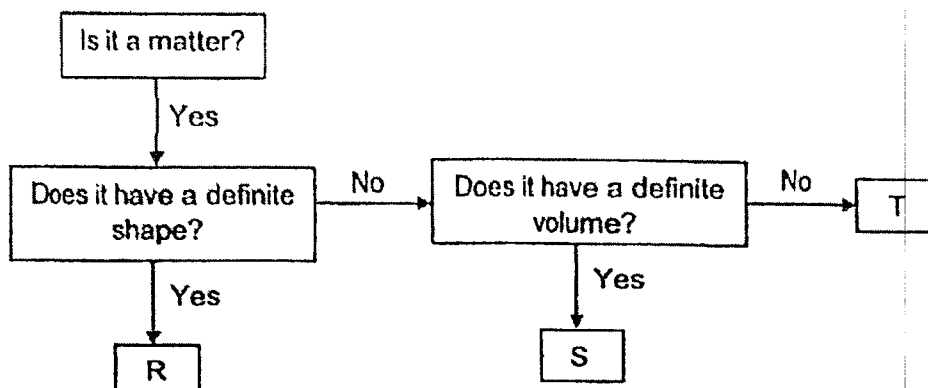

The table below shows the characteristics of objects C and D. A tick (✓) represents the characteristic an object possess.

Characteristic	Object	
	C	D
Occupies space	✓	✓
Can be compressed	✓	
Takes the shape of the container it is in	✓	

Based on the flow chart and the table above, which objects, R, S or T has similar characteristics as objects C and D?

	Object C	Object D
(1)	T	R
(2)	T	S
(3)	S	T
(4)	S	R

(Go on to the next page)

24 Peter cut out a heart-shaped piece of wood from a wooden block as shown. He then shone light on it.

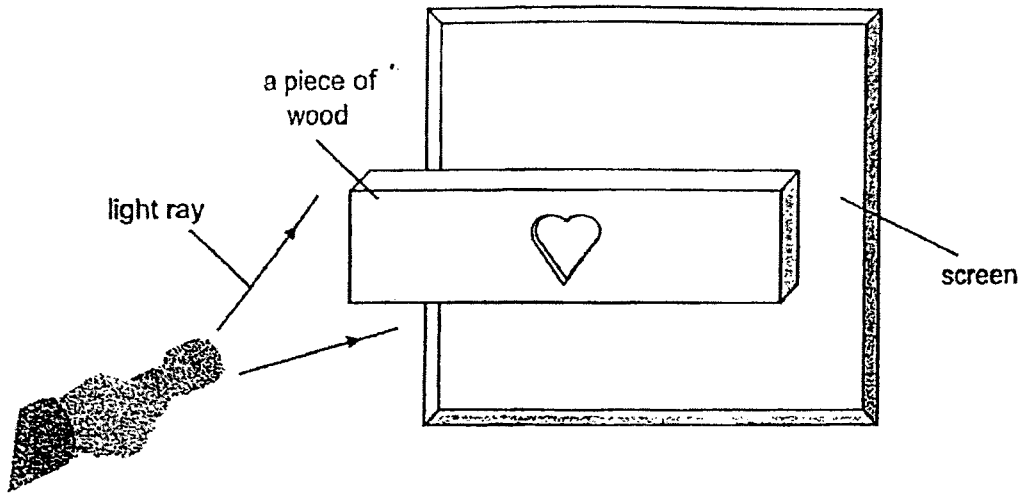

Which of the following image shows the correct image on the screen?

(1)

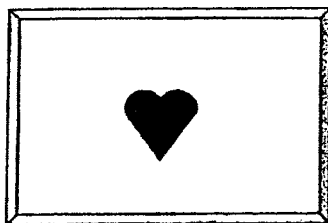

(2)



(3)

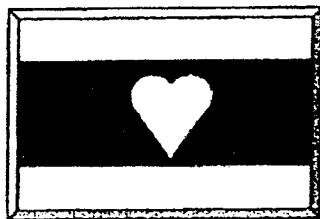

(4)

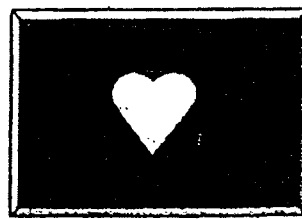

(Go on to the next page)

- 25 In a dark enclosed room, Tim placed two toys, X and Y, in a straight line. A candle is placed in the middle of the screens, A and B, and two toys as shown.

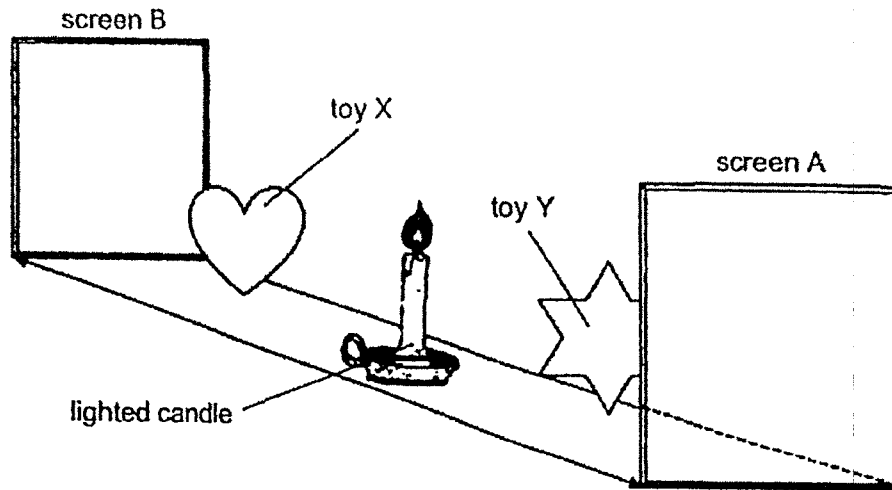

When the candle was lit, Tim moved toy Y towards the candle and toy X moves towards the screen B. The candle remained stationary.

Which of the following statement(s) above the size of the shadow is/are correct?

- A Toy Y's shadow increases in size on screen A.
- B Toy X's shadow increases in size on screen B.
- C Toy X's shadow increases in size on screen A.

- (1) A only
- (2) A and B only
- (3) B and C only
- (4) A, B and C

(Go on to the next page)

- 26 David prepared a beaker with 150 ml of water at 25 °C as shown below.

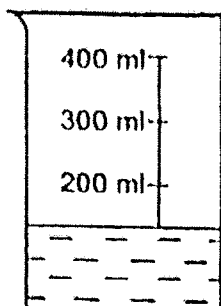

a beaker with 150 ml of  
water at 25 °C

He put some ice into the beaker.

What is a possible temperature of the water in the beaker after 2 minutes?

- (1) 0 °C
- (2) 15 °C
- (3) 30 °C
- (4) 45 °C

(Go on to the next page)



- 27 Mindy conducted an experiment with the set-up as shown below. She observed the temperature on Instrument A after some time.

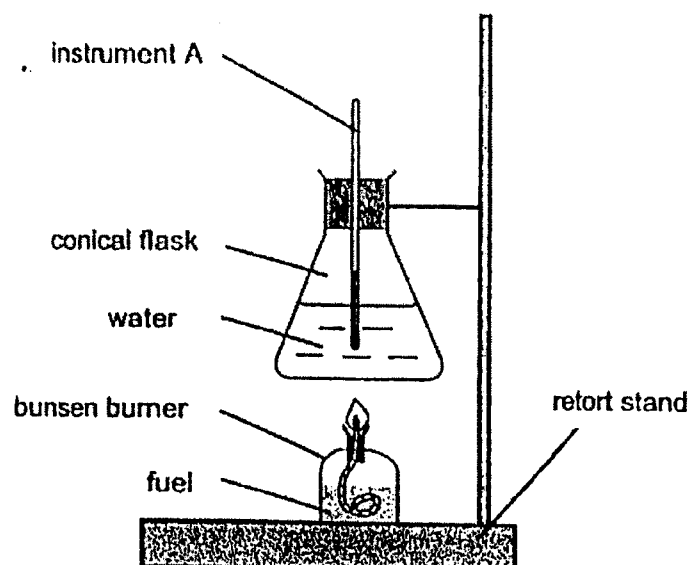

Which of the following statement(s) is/are correct?

- A Instrument A gains heat from the hot water and increases in temperature.
  - B Instrument A loses heat to the surroundings and decreases in temperature.
  - C Instrument A gains heat from the bunsen burner and decreases in temperature.
- (1) A only  
(2) C only  
(3) A and C only  
(4) B and C only

(Go on to the next page)

- 28 Ahmad set up an experiment as shown below to find out the ability of materials, W, X, Y and Z in conducting heat.

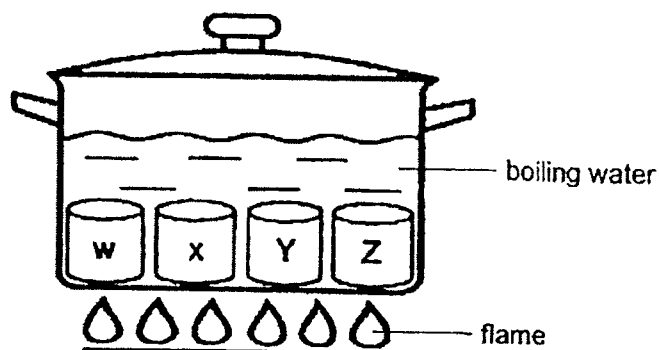

He submerged the materials into a pot of boiling water and recorded the temperature of each of the material in intervals of 5 minutes as shown below.

time (min)	temperature (°C)			
	Material W	Material X	Material Y	Material Z
0	25	25	25	25
5	34	50	42	27
10	42	72	57	29

Based on the results above, arrange the materials according to their ability to conduct heat.

	Poorest conductor of heat → Best conductor of heat
(1)	W, X, Y, Z
(2)	X, Y, Z, W
(3)	Y, Z, X, W
(4)	Z, W, Y, X

(Go on to Booklet B)



NAN HUA PRIMARY SCHOOL  
END-OF-YEAR EXAMINATION 2022  
PRIMARY 4

SCIENCE

BOOKLET B

13 Open-ended questions (44 marks)

Total Time for Booklets A and B: 1 hour 45 minutes

**INSTRUCTIONS TO CANDIDATES**

1. Write your name, index number and class in the spaces provided below.
2. Do not turn over the page until you are told to do so.
3. Follow all instructions carefully.
4. Answer all questions.
5. Use a dark blue or black ballpoint pen to write your answers in the space provided for each question.
6. Do not use correction fluid/tape or highlighters.

**Marks Obtained**

Section B		/ 44
-----------	--	------

Name: \_\_\_\_\_ (     )     Class: P 4S \_\_\_\_\_

Date: 27 October 2022

Parent's Signature: \_\_\_\_\_

This booklet consists of 20 printed pages.

**Section B: (44 marks)**

For questions 29 to 41, write your answers in the spaces provided.

The number of marks available is shown in brackets [ ] at the end of each question or part question.

29 Peter saw some living and non-living things in the park.

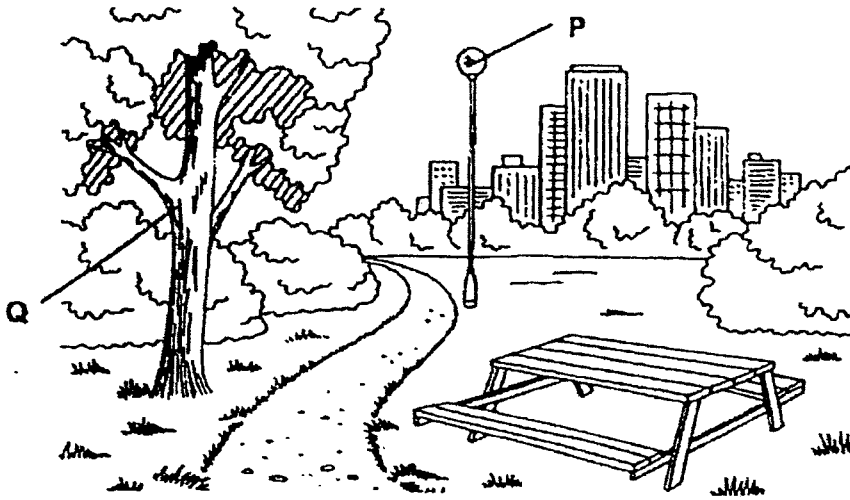

State if P and Q are living or non-living things.

(a) P is a \_\_\_\_\_ [1]

(b) Q is a \_\_\_\_\_ [1]

(Go on to the next page)

(c) Look at the diagram below.

[2]

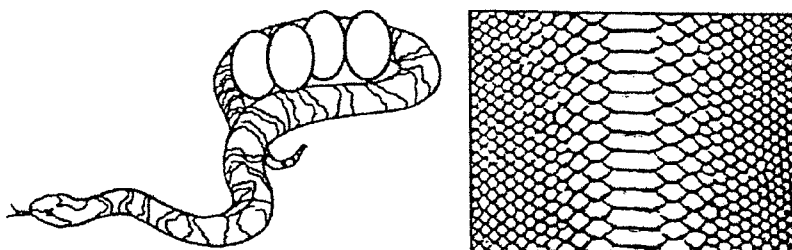

Tick (✓) 2 boxes below.

It is a reptile because \_\_\_\_\_.

- it lays eggs
- it has scales
- it has three body parts
- it breathes with its lungs

(Go on to the next page)

3

Score	4
-------	---

30 The diagram below shows the stages in the life cycle of a beetle.

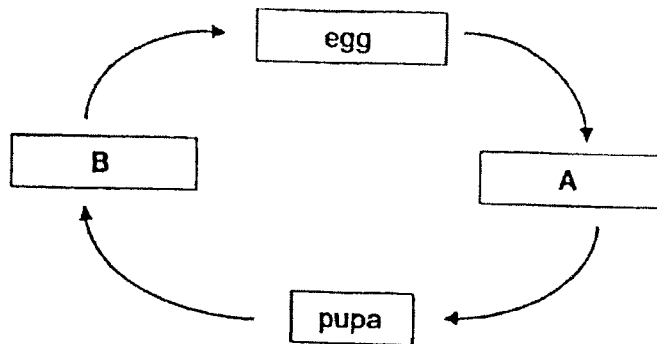

Choose the correct words from the box to answer the question below.

seed	larva	adult	nymph
------	-------	-------	-------

Name the two stages A and B.

[2]

A: \_\_\_\_\_

B: \_\_\_\_\_

(Go on to the next page)

4

Score	2
-------	---

- 31 When end X of object Q is brought near a magnet as shown, the magnet moves away.

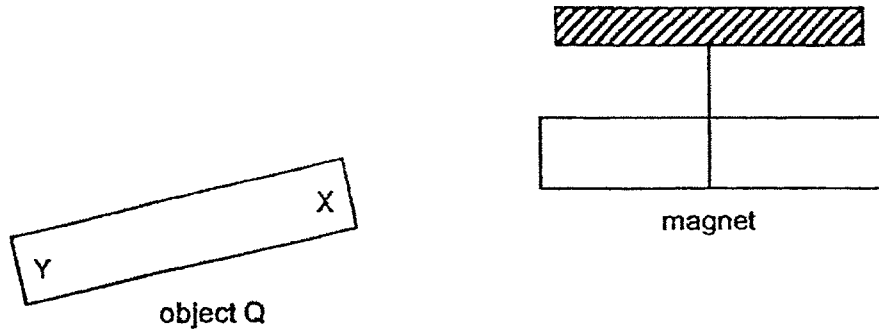

- (a) This shows that object Q is a \_\_\_\_\_ [1]
- (b) When end Y of object Q is brought near to the north pole of the magnet, it \_\_\_\_\_ the magnet. [1]
- (c) A magnet when hung freely will come to rest in a \_\_\_\_\_ direction. [1]

(Go on to the next page)

5

Score	3
-------	---

32 Johnny shines a torch on a toy and a shadow is formed on a smooth wall.

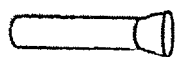

torchlight

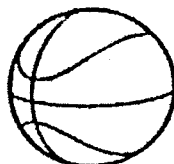

basketball



smooth

- (a) A shadow is formed when light is \_\_\_\_\_ by an object. [1]
- (b) Draw the shadow of the basketball that is formed on the wall. [1]

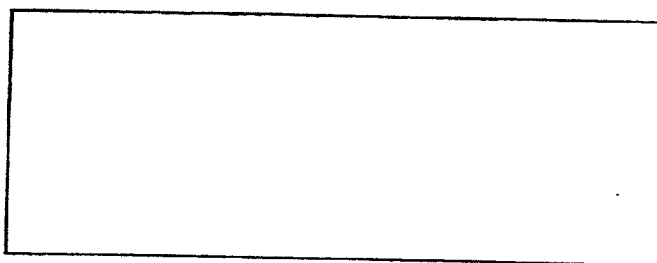

- (c) Johnny wants to make the shadow of the basketball smaller.  
Suggest a way to make that happen without moving the torchlight and the smooth wall. [1]

---



---

- (d) Johnny wants to make the shadow of the basketball bigger instead.  
Suggest a way to make that happen without moving the basketball and the smooth wall. [1]

---



---

(Go on to the next page)

6

Score	4
-------	---



- 33** Tim used an instrument to measure the temperature of water in a beaker as shown below.

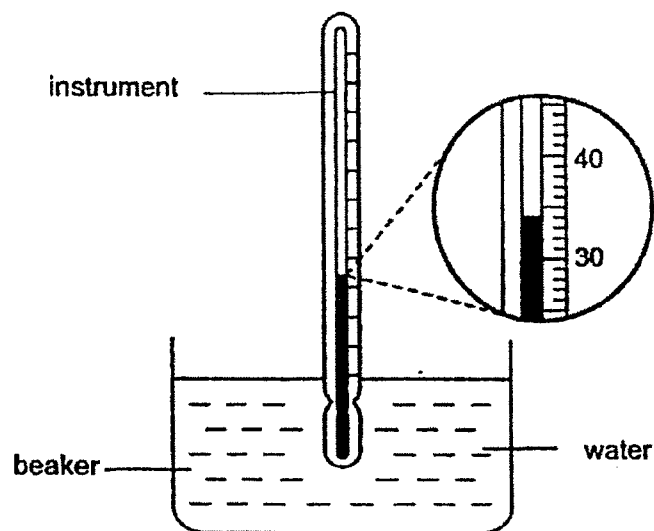

- (a) What is the name of the instrument? [1]

\_\_\_\_\_

- (b) What is the temperature of the water in the beaker? \_\_\_\_\_ °C [1]

- (c) State what is temperature. [1]

\_\_\_\_\_  
\_\_\_\_\_

(Go on to the next page)

7

Score	3
-------	---

34 The diagram shows a human digestive system.

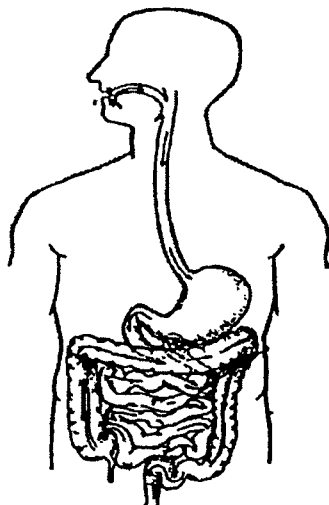

- (a) In the diagram above, label the part of the digestive system where food is absorbed. [1]
- (b) Jason's mother had told him to chew his food longer before swallowing so that he can digest his food faster.  
Do you agree with her? Explain your answer. [2]

---

---

---

---

(Go on to the next page)

8

Score	/
	3

- 35 Mr Lee carried out an experiment to test out a property of a rod made of material P. He secured one end of the rod on the tabletop using a clamp and taped a 100 g mass at the end of the rod. He observed that the rod moved downwards and measured the distance,  $X$ , as shown below.

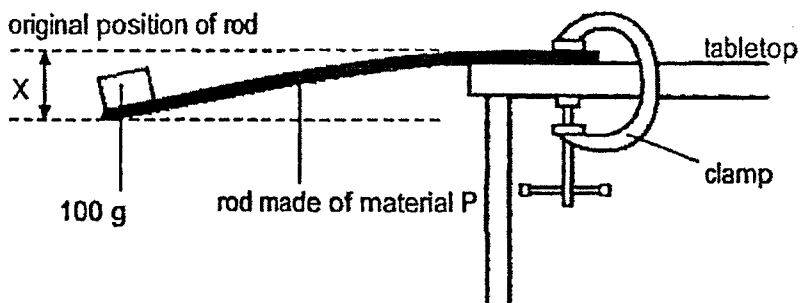

He repeated the experiment with 2 other rods made of materials Q and R and recorded all the results in the table below.

Material	Distance $X$ (cm)
P	8
Q	0
R	3

- (a) What was the property of the rods that Mr Lee was most likely investigating in the experiment above? [1]
- \_\_\_\_\_
- (b) Identify the changed (independent) variable in the experiment. [1]
- \_\_\_\_\_
- (c) Which material, P, Q or R, is the most suitable to make into a food tray? Explain your answer. [2]
- \_\_\_\_\_
- \_\_\_\_\_
- \_\_\_\_\_

(Go on to the next page)

Score	4
-------	---

36 In some places, the doors for the office are fitted with an electromagnet as shown below to ensure that the doors always remain closed. To open the door, a switch has to be pressed to open the circuit which will result in a short disconnection to an electrical supply.

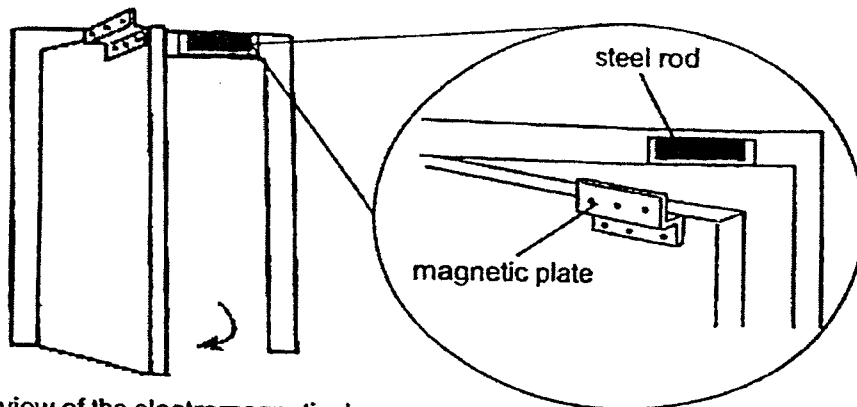

front view of the electromagnetic door

close-up view of the electromagnetic part

The diagram below shows the circuit to operate the electromagnet.

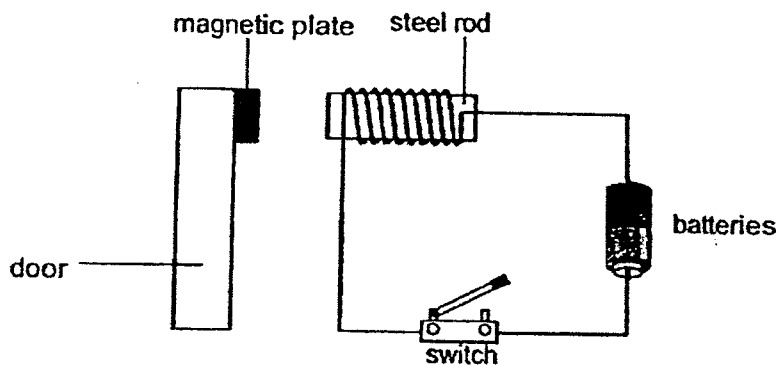

(a) Explain clearly how the door stays locked when the switch is closed. [2]

---



---



---

(Go on to the next page)

(b) State two ways in which the strength of the electromagnetic door lock can be increased. [2]

(i) \_\_\_\_\_

(ii) \_\_\_\_\_

(Go on to the next page)

Score	4
-------	---

- 37 Sandy transferred  $100\text{ cm}^3$  of water from a beaker to an empty flask as shown below.

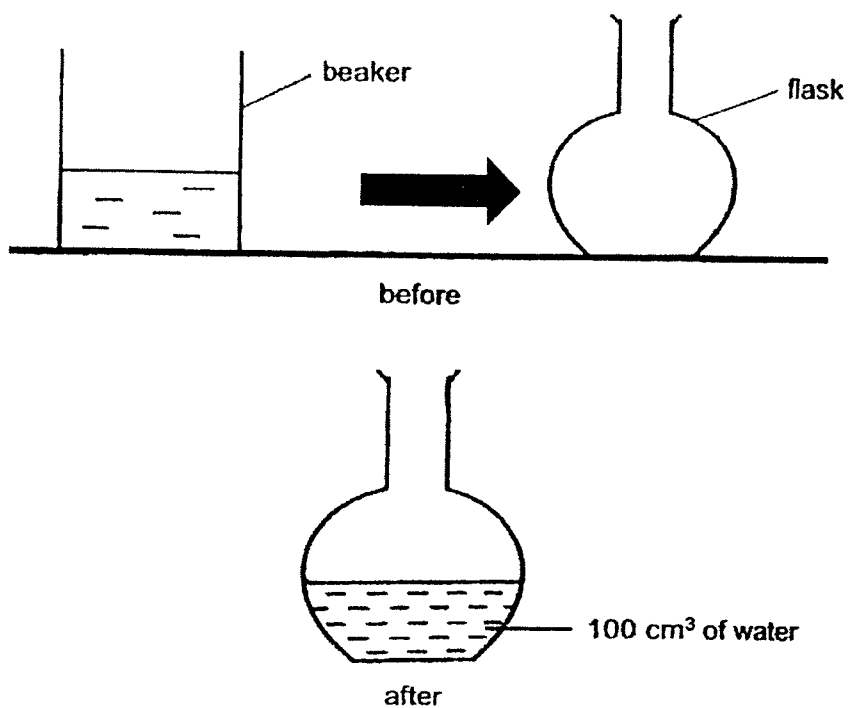

- (a) State two properties of water when it is a liquid. Explain in terms of shape and volume. [1]

---

---

(Go on to the next page)

- (b) Sandy then attached a stopper, a delivery tube and a syringe to the flask containing the  $100\text{ cm}^3$  of water. The flask has a capacity of  $250\text{ cm}^3$ .

The plunger was pushed inwards twice.  $150\text{ cm}^3$  of air enters the flask each time the plunger was pushed in.

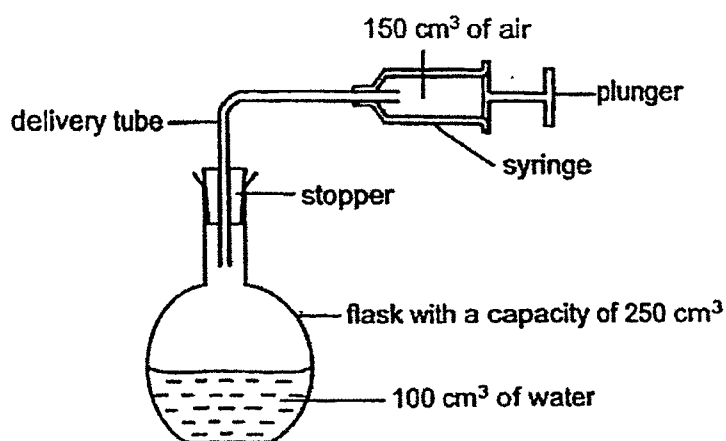

What is the final volume of the air in the flask after the plunger was pushed in twice? [1]

---

- (c) State one property of air that best explains your answer in part (b). [1]

---



---

(Go on to the next page)

Score	3
-------	---

- 38 Jason was planning to go for a holiday and he packed his clothes into a luggage. However, it would not fit as shown in diagram 1.

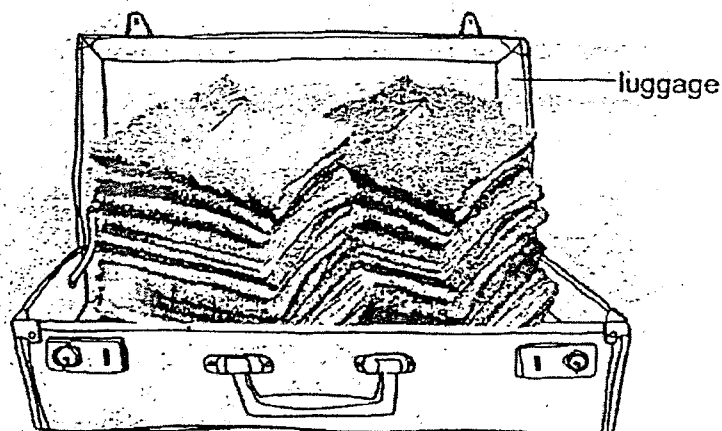

Diagram 1

- (a) Why was he not able to fit all his clothes in the luggage as shown above?  
Explain your answer in terms of volume. [1]

---



---

He placed the two piles of clothes of equal masses into two vacuum bags, A and B. He used a suction machine to remove air from bag A, and sealed it as shown in diagram 2 below.

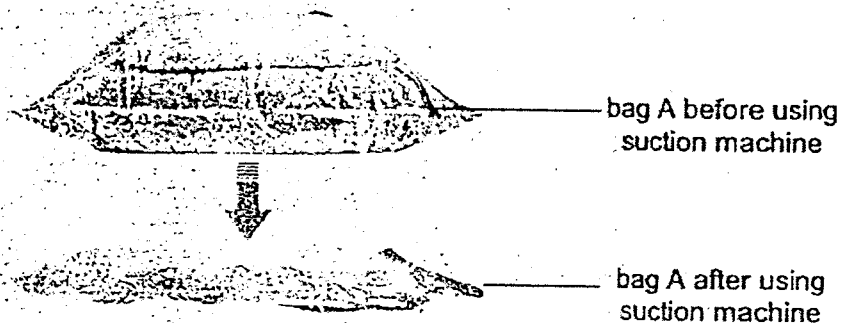

Diagram 2

(Go on to the next page)



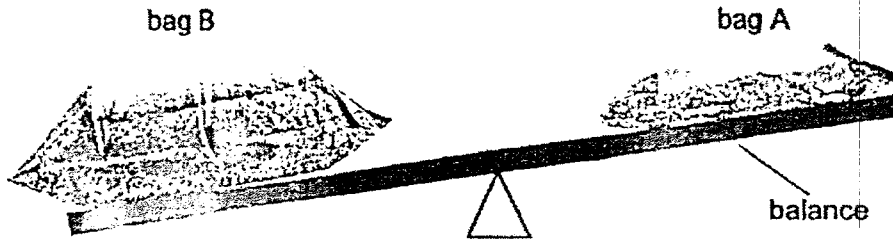

Diagram 3

He placed the two vacuum bags on a balance and observed that the balance tilted to the left as shown in diagram 3.

(b) Why did the balance in diagram 3 tilted to the left? [2]

---

---

---

(c) Jason wants to find out the mass of bag B. He uses the instrument as shown below.

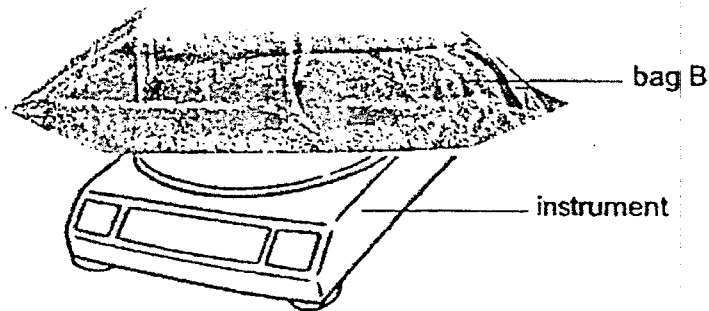

What is the name of the instrument used to measure the mass of the bag B? [1]

---

(Go on to the next page)

Score	
	4

- 39 In the setup below, an object is placed in the centre with four light bulbs, W, X, Y and Z around it. Only one of the four bulbs is lighted up.

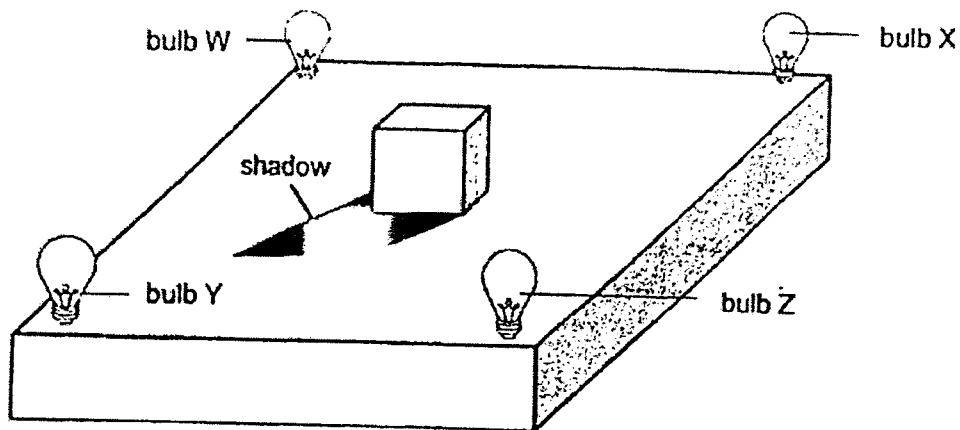

- (a) Which light bulb needs to be switched on to form the shadow as shown above? [1]
- \_\_\_\_\_
- (b) What property of the object enables it to form the shadows as shown? [1]
- \_\_\_\_\_
- (c) State the property of light that allows the shadow to be formed as shown above. [1]
- \_\_\_\_\_

(Go on to the next page)

Score	3
-------	---

- 40 Jane prepared three identical bowls, A, B and C, as shown below. She then poured different amount of hot soup into each bowl. The temperature of the soup in each bowl was  $60^{\circ}\text{C}$ . The bowls were left on a table in a room temperature of  $25^{\circ}\text{C}$ .



room temperature:  $25^{\circ}\text{C}$

After 10 minutes, she recorded the temperatures of the soup in each bowl in the table below.

Bowl	A	B	C
volume of hot soup (ml)	100	150	200
starting temperature ( $^{\circ}\text{C}$ )	60	60	60
temperature after 10 min ( $^{\circ}\text{C}$ )	45	X	50

- (a) State a possible temperature for X. [1]

---

- (b) Jane drank all the soup from bowls A and B. She left the soup in bowl C on the table to cool until it has reached a constant temperature.

- (i) State the constant temperature of the soup in bowl C. [1]

---

- (ii) Explain your answer to (i). [1]

---



---

(Go on to the next page)

Score	3
-------	---

41 The diagram below shows a metal pot.

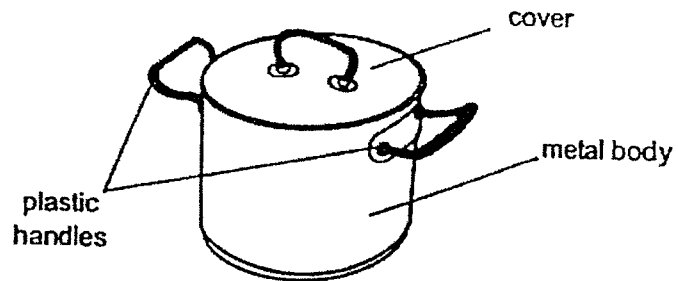

- (a) The handles of the pot are made of plastic because it is a  
(i) \_\_\_\_\_ conductor of heat.

The body of the pot is made of metal because it is a  
(ii) \_\_\_\_\_ conductor of heat.

[1]

(Go on to the next page)

- (b) Timothy removed the pot cover and placed it on the cooler kitchen top while boiling some water. After boiling the water under strong flame for 30 minutes, he observed the amount of water in the pot decreased and there was a change in the state of water.

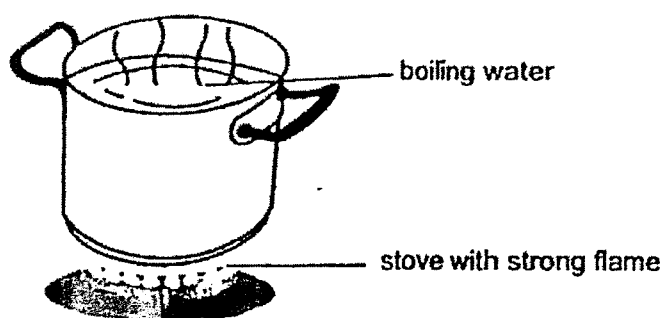

- (i) Fill in the boxes below to show the change in state of water during the boiling process. [1]

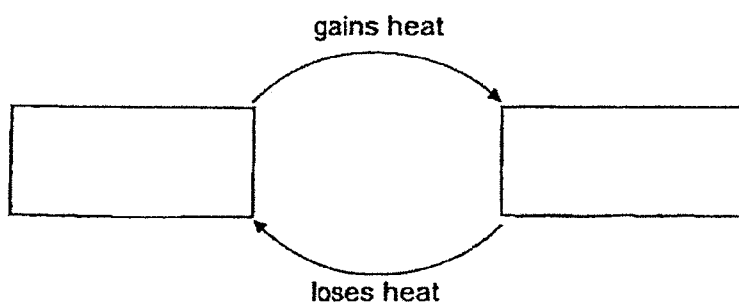

(Go on to the next page)

Timothy placed the cover back on the metal pot. He noticed a small gap between the cover and the metal pot, and the cover could not fit on the metal pot completely.

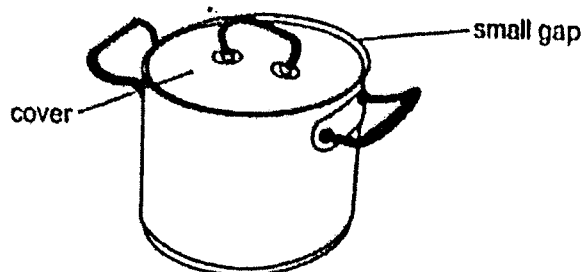

(ii) Explain why the cover did not fit completely onto the metal pot now. [2]

---

---

---

~ End of Paper ~

Score	4
-------	---

SCHOOL : NAN HUA PRIMARY SCHOOL

LEVEL : PRIMARY 4

SUBJECT : SCIENCE

TERM : 2022 SA2

**SECTION A**

Q 1	Q2	Q3	Q4	Q5	Q6	Q7	Q8	Q9	Q10
3	1	4	3	2	1	3	2	4	3

Q 11	Q12	Q13	Q14	Q15	Q16	Q17	Q18	Q19	Q20
2	4	2	4	3	3	4	3	2	1

Q 21	Q22	Q23	Q24	Q25	Q26	Q27	Q28
4	2	1	3	1	2	1	4

**SECTION B**

Q29)	a) non-living thing b) living thing c) it lays eggs it has scales
Q30)	A: larva B: adult
Q31)	a) magnet b) attracts c) north-south
Q32)	a) blocked b) 

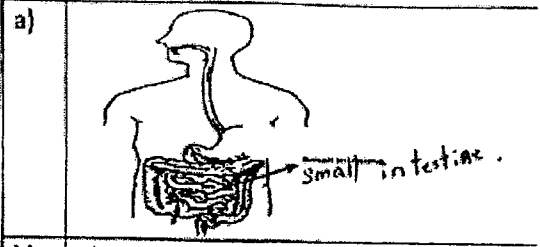
	<p>c) place the basketball nearer to the smooth wall.</p> <p>d) Place the torch light nearer to the basketball.</p>
Q33)	<p>a) thermometer</p> <p>b) 34</p> <p>c) Temperature is measure of the degree of hotness or coldness of an object.</p>
Q34)	<p>a)</p>  <p>b) The teeth cuts the food into smaller pieces. There is a greater exposed surface are in contact with the digestive juice, hence, digestive is faster.</p>
Q35)	<p>a) flexibility of the rods</p> <p>b) The material of the rod</p> <p>c) The rod did not bend, The rod is not flexible so that the food can be placed on the tray without spilling.</p>
Q36)	<p>a) When the switch is closed the steel rod is magnetized and becomes an electromagnet and attracted the magnetic place.</p> <p>b) i) Place more batteries. ii) Coil more wire around the steel rod.</p>
Q37)	<p>a) Water has no definite shape but has a definite volume.</p> <p>b) 150cm<sup>3</sup></p> <p>c) Air can be compressed.</p>
Q38)	<p>a) His clothes have a greater volume</p> <p>b) The air bag B is not vacuumed as there is air and air has mass, therefore causing bag B to be heavier than bag A.</p> <p>c) Electronic Balance.</p>
Q39)	<p>a) Bulb X</p> <p>b) Opaque</p>



	<p>c)Light will be blocked if there is an opaque object causing it to have shadow.</p>
Q40)	<p>a)48 b)i)25 ii)Soup C lost it heat to the surrounding causing it to reach room temperature.</p>
Q41)	<p>a)i)poor ii)good b)i)Liquid →gains heat → Gas → loses heat ii)The metal pot expanded as it was gaining heat causing the cover not to fit metal pot.</p>

