

Name: _____ ()

Class: Primary 4 _____

CHIJ ST NICHOLAS GIRLS' SCHOOL

Primary 4
End Year Assessment
SCIENCE
BOOKLET A

27 October 2023**Total Time for Booklets A and B: 1 hour 45 minutes****28 questions**
56 marks

Do not open this booklet until you are told to do so.
Follow all instructions carefully.
Answer all questions.

This booklet consists of 18 printed pages.

Section A: (28 x 2 = 56 marks)

For each question from 1 to 28, 4 options are given. One of them is the correct answer. Make your choice (1, 2, 3 or 4). Shade the correct answer (1, 2, 3 or 4) in the Optical Answer Sheet (OAS) provided.

1. Roger planted a seed and watered it every day. He observed the growth of the seed and recorded the length of three different parts of the young plant X, Y and Z, in the table below.

Day	Length of Part X (units)	Length of Part Y (units)	Length of Part Z (units)
3	1	0	0
6	2	0	0
9	4	3	0
12	5	4	0
18	7	7	4

Based on the table above, which of the following is correct?

	Green leaf	Root	Shoot
(1)	X	Y	Z
(2)	Y	X	Z
(3)	Z	Y	X
(4)	Z	X	Y

2. The diagram below shows the life cycle of an animal.

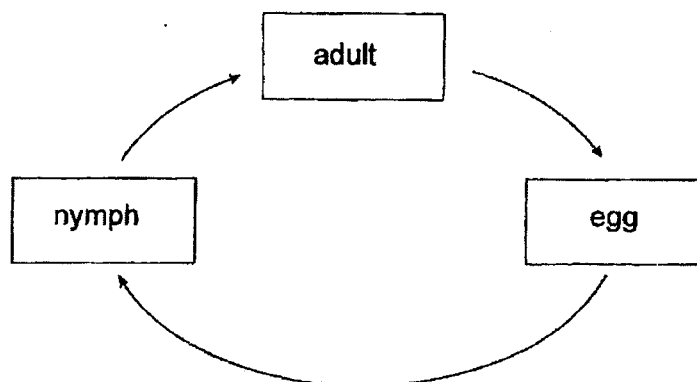

Which animal is likely to have the life cycle as shown above?

- (1) beetle
- (2) chicken
- (3) butterfly
- (4) Cockroach

3. Rui-En wanted to investigate the effect of the type of soil used on the growth of plants. She planted three similar plants in three pots X, Y and Z.

	Pot X	Pot Y	Pot Z
Type of soil	garden soil	clay soil	sandy soil
Amount of water (ml)	150	300	250
Temperature of surrounding ($^{\circ}\text{C}$)	30	30	30

Her teacher told her that the experiment was not a fair test. Which of the following variables make her experiment an unfair one?

- (1) The type of soil used was different.
 - (2) The amount of water used was different.
 - (3) The temperature of the surrounding is the same.
 - (4) The type of plant used in the experiment was similar.
4. What will happen if all the flowers of the plant below are plucked off?

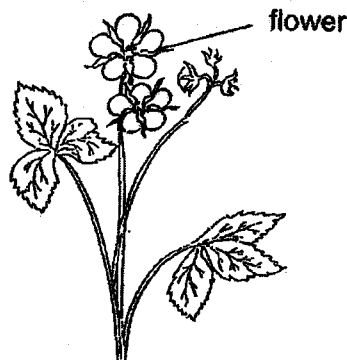

- (1) The plant will not be able to reproduce.
- (2) The plant will not be able to make food.
- (3) The plant will not be able to stand upright.
- (4) The plant will not be able to take in water and minerals.

5. The diagram below shows how the roots of a tree grow wider and deeper into the soil.

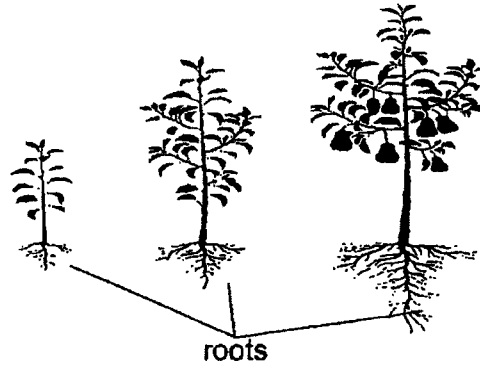

Which of the following best explains why the roots grow in such a way as the plant grows taller?

- (1) The roots need more space to grow.
 - (2) The roots need to take in more air from the soil.
 - (3) The roots need to take in more food from the soil.
 - (4) The roots need to take in more water from the soil.
6. Which part (1), (2), (3) or (4), makes food for the plant?

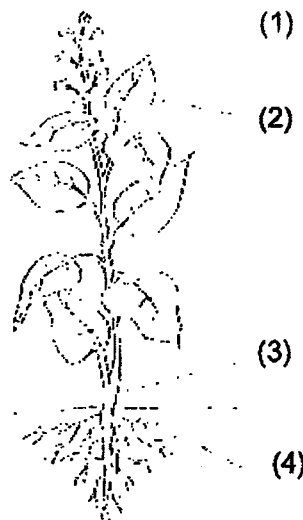

7. Study the flow chart below.

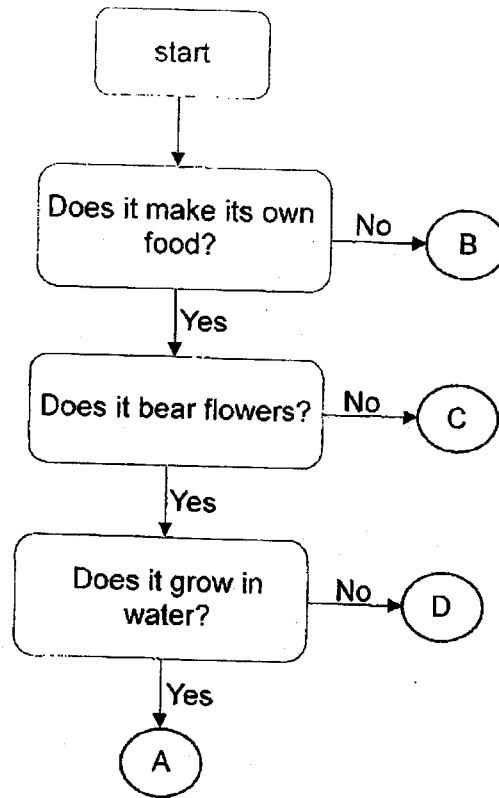

The diagram below shows a water lily.

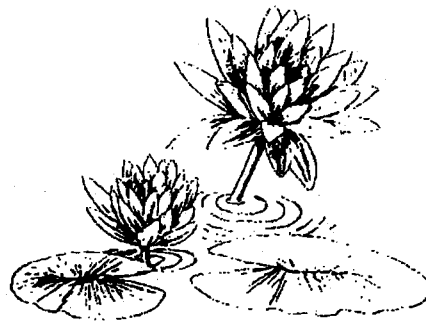

Which of the following in the flow chart above best represents a water lily?

- (1) A
- (2) B
- (3) C
- (4) D

8. Plants W, X and Y have characteristics as shown in the table below. A tick (✓) in the box indicates the presence of such a characteristic.

Characteristics of plants			
	W	X	Y
Produces flowers	✓		✓
Bears edible fruits	✓		
Reproduces by spores		✓	

Using the information above, John grouped the plants in the classification table below.

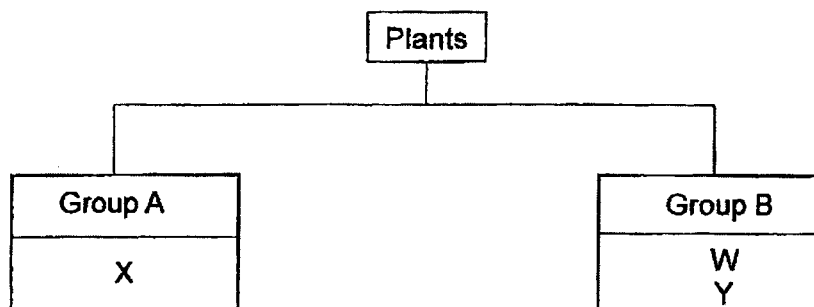

What are the suitable sub-headings for Group A and Group B?

	Group A	Group B
(1)	ferns	moss
(2)	bears fruit	does not bear fruit
(3)	bears edible fruits	bears inedible fruits
(4)	non-flowering plants	flowering plants

9. Which statement is true about most mammals?
- (1) They can swim.
 - (2) They have wings.
 - (3) They produce milk.
 - (4) They have four legs.
10. Henry found an animal in a river near a forest. Which of the following characteristic should he use to identify it as a fish, a reptile or an amphibian?
- (1) presence of gills /
 - (2) outer body covering
 - (3) method of reproduction
 - (4) whether it can live both on land and in water

11. The flow chart below shows some characteristics of 4 animals.

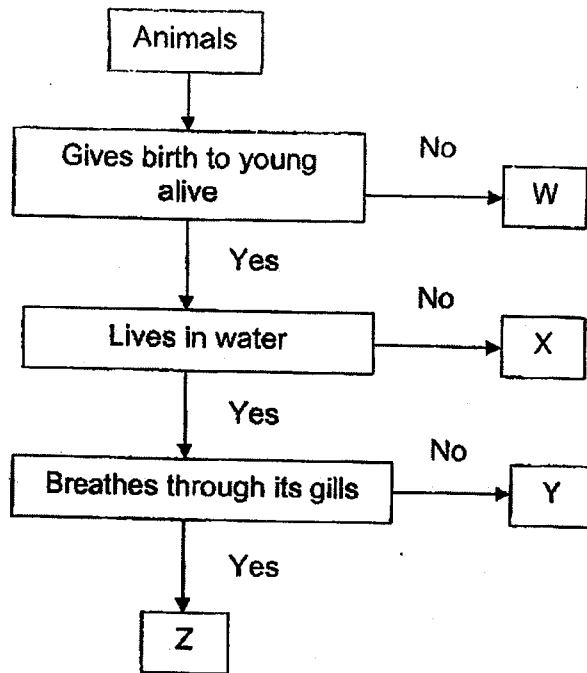

Which letter W, X, Y and Z, represents the shark?

- (1) W
- (2) X
- (3) Y
- (4) Z

12. The diagram shows two types of fungi.



mushroom

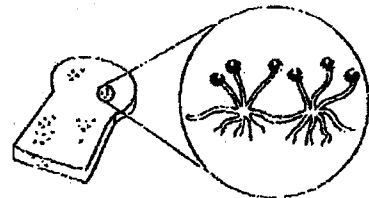

mould

Which statement is true of fungi?

- (1) They are flowering plants.
- (2) They reproduce by spores.
- (3) They make food on their own.
- (4) They are non-flowering plants.

13. Which of the following substances has a fixed shape?

- (1) air
- (2) oil
- (3) stone
- (4) water

14. Study the flow chart below.

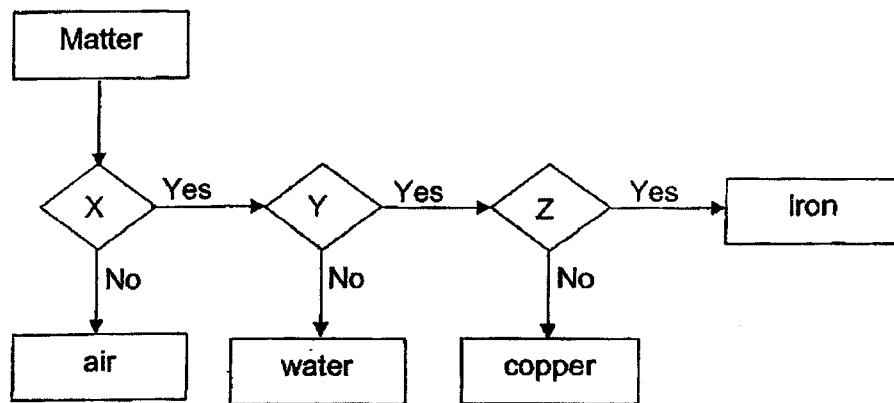

Which of the following sets of questions can X, Y and Z represent?

	X	Y	Z
(1)	Does it have a definite volume?	Is it magnetic?	Is it a solid?
(2)	Is it a solid?	Does it have a definite volume?	Is it magnetic?
(3)	Does it occupy space?	Does it have a definite volume?	Is it a metal?
(4)	Does it have a definite volume?	Is it a solid?	Is it magnetic?

15. The container below is filled with some water.

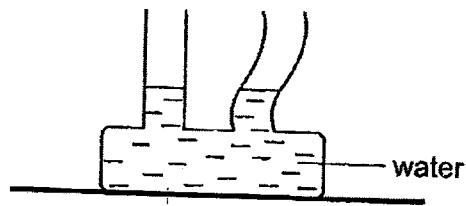

Which one of the following diagrams shows the correct position of the water level in the container when it is tilted?

(1)

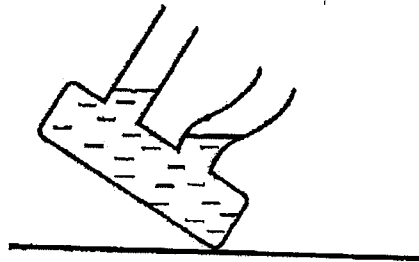

(2)

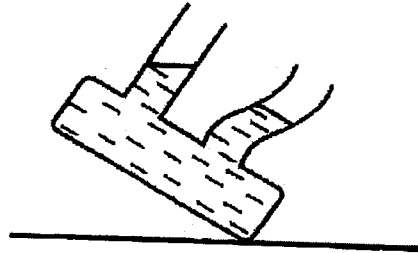

(3)

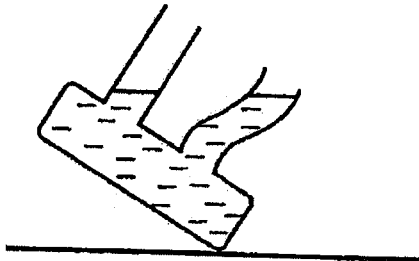

(4)

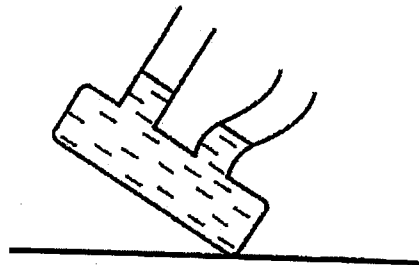

16. The diagram shows a magnet brought near a glass block.

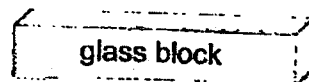
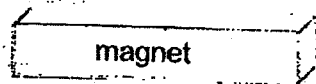

What will happen to the glass block?

- (1) It will move up.
- (2) It will not move.
- (3) It will move to the left.
- (4) It will move to the right.

17. A compass has a small magnet that can rotate freely as shown.

North pole of a small magnet

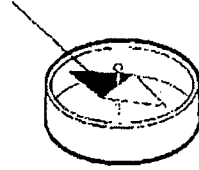

Four bar magnets were arranged such that they were attracted to one another. A compass was then placed near end P and the direction of the compass was shown below.

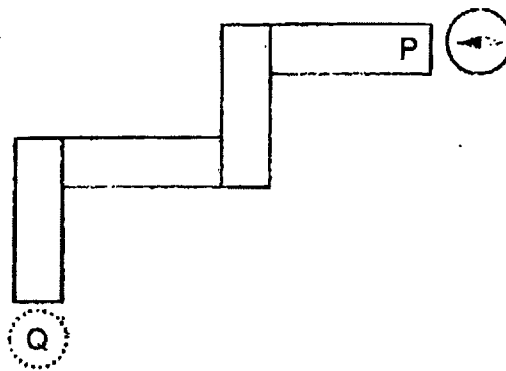

What would be the direction of the needle if the compass was placed at Q?

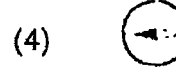

18. Marlina placed a magnet on top of a balance as shown in Diagram 1.

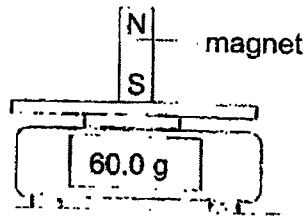

Diagram 1

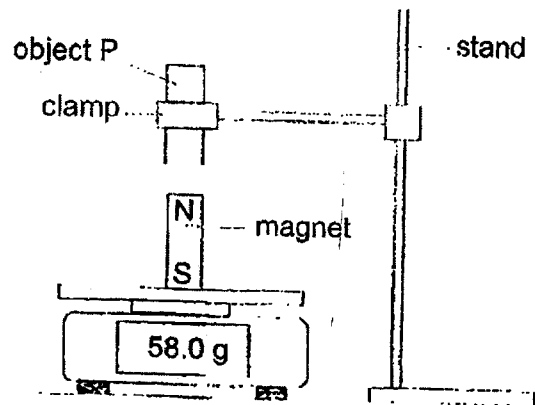

Diagram 2

She brought object P close to the magnet as shown in Diagram 2.

What could object P be?

A



a magnet

B



a magnet

C



a copper bar

D



a nickel bar

- (1) A and B only
- (2) A and C only
- (3) B and C only
- (4) B and D only

19. Which of the following is a source of light?

(1)



eyes

(2)

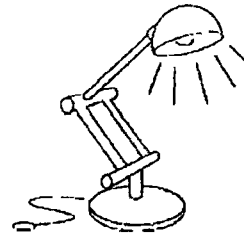

Lamp

(3)

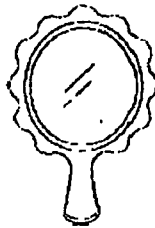

mirror

(4)



Moon

20. Study the diagram below.

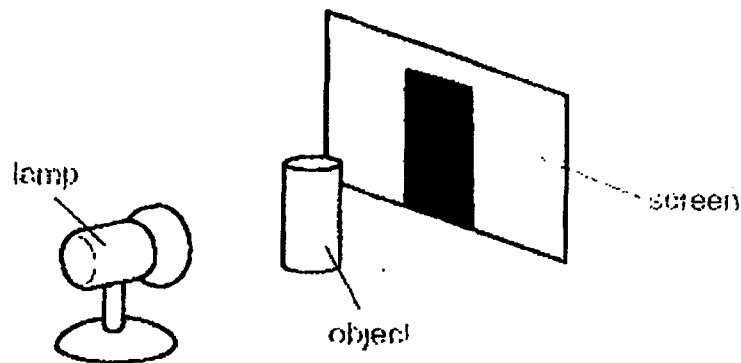

The shadow of the object is formed on the screen because _____.

- (1) The object blocks light.
- (2) The object gives off light.
- (3) The object reflects light.
- (4) The screen absorbs light.

21. Danny stood under a lamp as shown below.

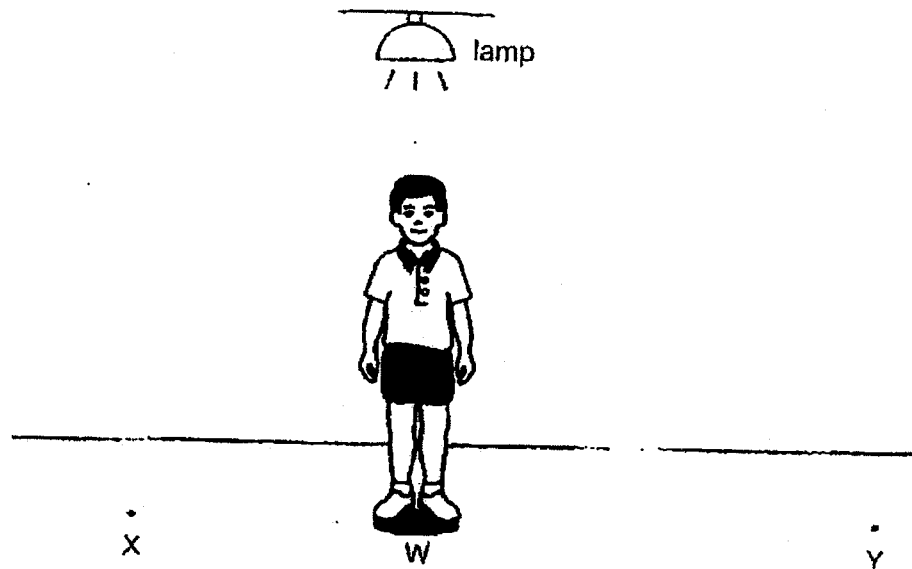

The graph below shows how the length of his shadow changed as he walked from W to different positions under the lamp.

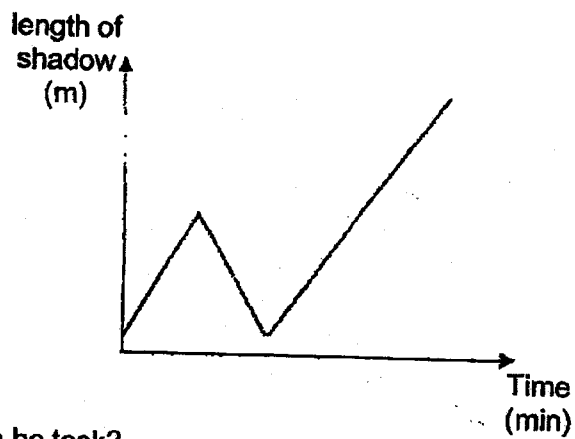

What is the path he took?

- (1) $W \rightarrow X \rightarrow W \rightarrow Y$
- (2) $W \rightarrow Y \rightarrow W \rightarrow X$
- (3) $X \rightarrow W \rightarrow X \rightarrow Y$
- (4) $Y \rightarrow W \rightarrow X \rightarrow W$

22. John wanted to find out how materials X and Y affect the amount of light passing through each material. He placed each material in the wooden box one at a time and measured the amount of light passing through using a light sensor as shown below.

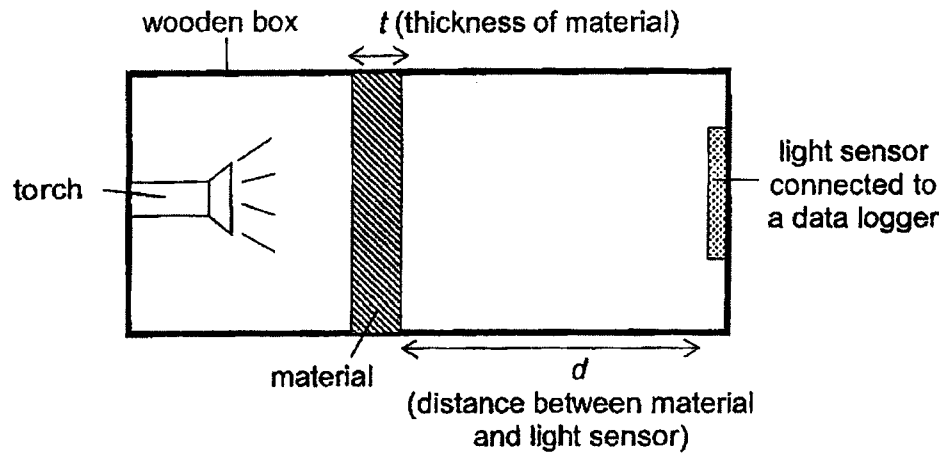

Results of his experiment are shown below.

set-up	material	t (cm)	d (cm)
A	X	2	15
B	X	4	15
C	Y	2	12
D	Y	4	15

Which of these set-ups should John compare for a fair test?

- (1) A and B only
- (2) A and D only
- (3) B and C only
- (4) B and D only

23. A wooden block had a cone-shaped top and a cylindrical bottom. A star-shaped hole was cut through the block as shown in the diagram below.



If Elaine shines a torch at the wooden block from different directions, which of the following shadows could be formed by the block?

A



B



C



D



- (1) A and B only
- (2) B and C only
- (3) A, B and C only
- (4) A, C and D only

24. Kim carries some books in a clear plastic bag.

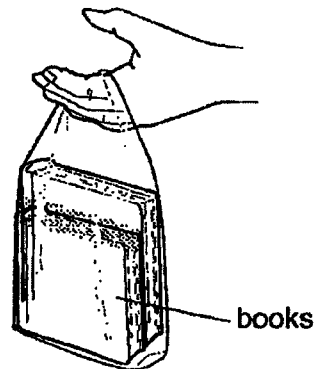

The books in the plastic bag will not get wet. This is because plastic bag is _____.

- (1) light
- (2) strong
- (3) flexible
- (4) waterproof

25. Hashim boils some water in the metal pot shown below.

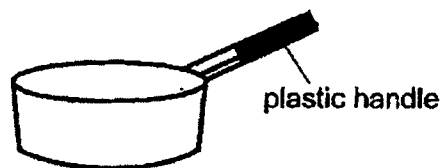

He is able to hold the pot of boiling water using the plastic handle. This is because plastic is a _____.

- (1) light material
- (2) flexible material
- (3) poor conductor of heat
- (4) good conductor of heat

26. A glass containing a block of ice and some water was placed in a room. The room temperature was 25 °C.

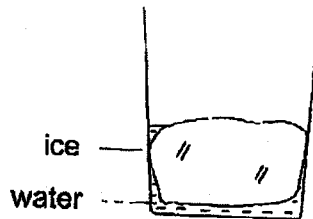

Which of the following is true about the ice in the glass?

- (1) It will change into a gas.
 - (2) It will lose heat to the water.
 - (3) It will gain heat from the surroundings.
 - (4) It will no longer have a definite volume.
27. Study the diagram below.

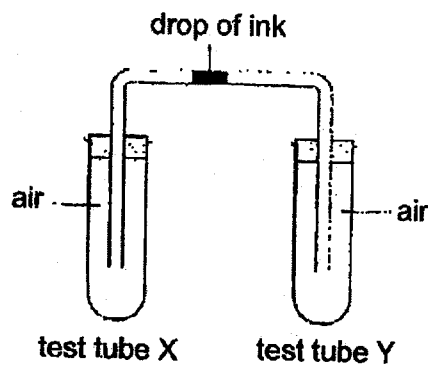

If test tube Y is heated, the drop of ink will _____

- (1) dry up
- (2) become bigger
- (3) move to the left
- (4) move to the right

28. Containers in set-ups A, B and C below are of the same size and thickness but made of different materials. The containers were filled with the same volume of water at 100 °C and left on the table.

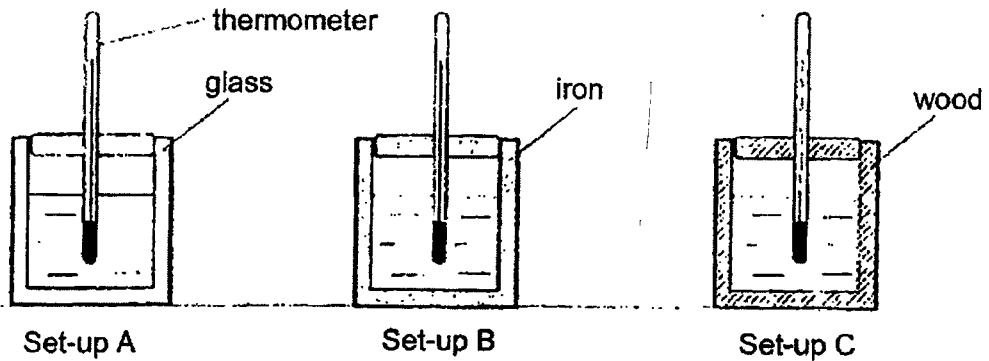

Which graph correctly shows the temperature of water in the three set-ups over a period of time?

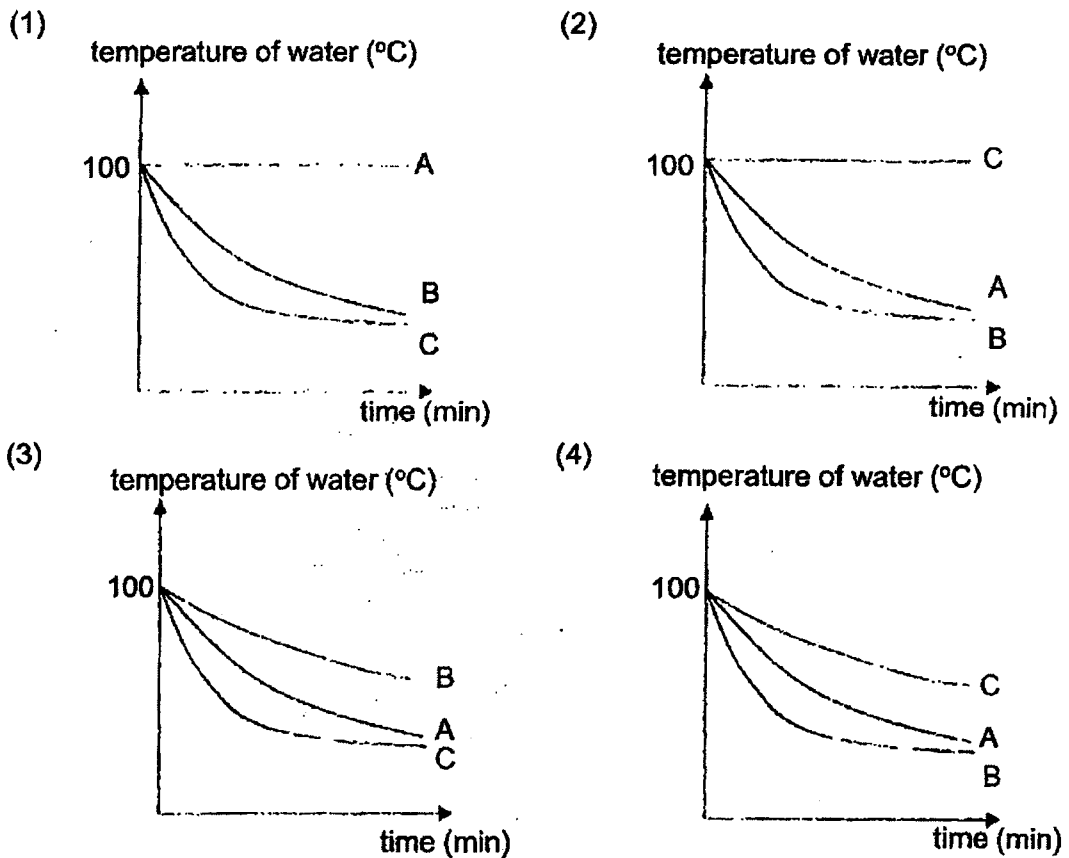

END OF BOOKLET A

Name : _____ ()

Class : Primary 4 _____

CHIJ ST NICHOLAS GIRLS' SCHOOL

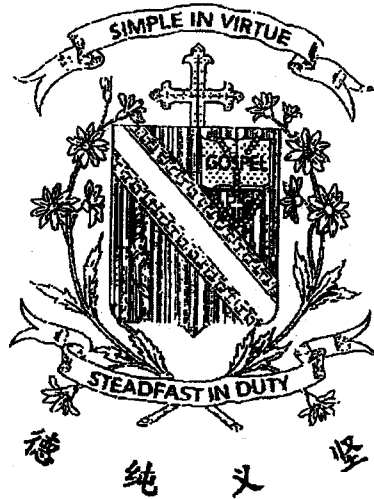

Primary 4
End Year Assessment
SCIENCE
BOOKLET B
27 October 2023

Total Time for Booklets A and B: 1 hour 45 minutes

13 questions
44 marks

Do not open this booklet until you are told to do so.
Follow all instructions carefully.
Answer all questions.

This booklet consists of 15 printed pages.

Booklet A	56
Booklet B	44
Total	100

Parent's Signature/Date

Section B (44 marks)

For questions 29 to 41, write your answers in this booklet. The number of marks available is shown in the brackets at the end of each question or part question.

29. The diagrams below show the life cycles of a cockroach and a butterfly.

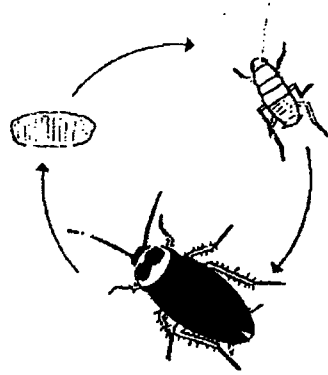

cockroach

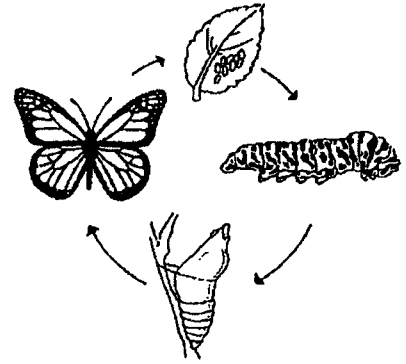

butterfly

- (a) Based only on what could be observed in the diagrams above, list one difference between the life cycle of the cockroach and the life cycle of the butterfly. (Do not compare the size, shape and colour.) [1]

- (b) Butterflies lay many eggs on leaves at one time. Suggest one advantage of this behaviour. [1]



30. Evelyn wanted to find out if light is needed for seeds to germinate. She has the following materials.

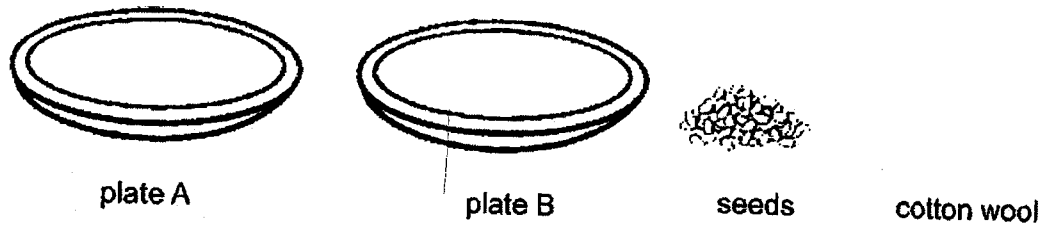

(a) Arrange the steps in the correct order using numbers 1 to 5, in the table below to show how she should carry out the experiment. **Step 3** has been given as shown. [2]

Steps	Procedures
	Wet some cotton wool and place them on plate A and B.
	Add equal amount of water daily to the cotton wool.
3	Place the plates with cotton wool and seeds at 2 different locations.
	Put equal number of seeds on each plate A and B.
	Observe the seeds on both plates daily to record the results.

(b) Suggest 2 locations to place each of her plates for the experiment. [1]

Location 1:

Location 2 :



31. Sandy carried out an experiment with three identical slices of bread A, B and C. After a week, she recorded the amount of mould seen on the pieces of bread.

The result of her experiment is shown in the table below.

Bread	A	B	C
Amount of water given (ml)	10	15	20
Location where the bread was placed	On the dining table	On the dining table	On the dining table
Amount of mould growth (cm ²)	8	12	18

- (a) What is the aim of the above experiment? [1]



- (b) What conclusion can she make based on the results of the experiment? [1]

- (c) Based on the results shown in the table, state one characteristic of living things. [1]

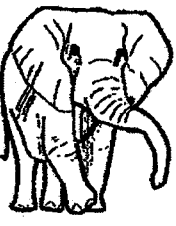

32. Identify the outer covering of each animal group by choosing the words from the box. [3]

moist skin	scales	hair	feathers
------------	--------	------	----------

	Animal group	Outer covering
(a)	 reptile	
(b)	 mammal	
(c)	 bird	

Diva spotted an animal in his garden as shown below.

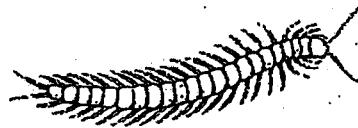

(d) She concluded that it is not an insect. Do you agree with her? Give a reason for your answer. [1]





33 (a) State what is matter.

[1]

(b) Which of the following equipments can be used to measure the mass of an apple? [2]

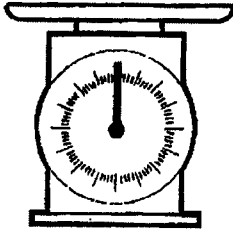
Tick (✓) **two** correct boxes.

 <input type="checkbox"/>	 <input type="checkbox"/>
 <input type="checkbox"/>	 <input type="checkbox"/>



34. Mingwei placed an empty bottle with two holes at points P and Q into a tank of water as shown.

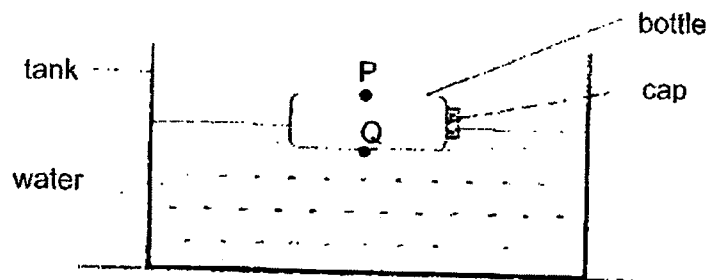

- (a) Explain why the bottle sank after a while.

[2]

Alex conducted an experiment using the set-up as shown.

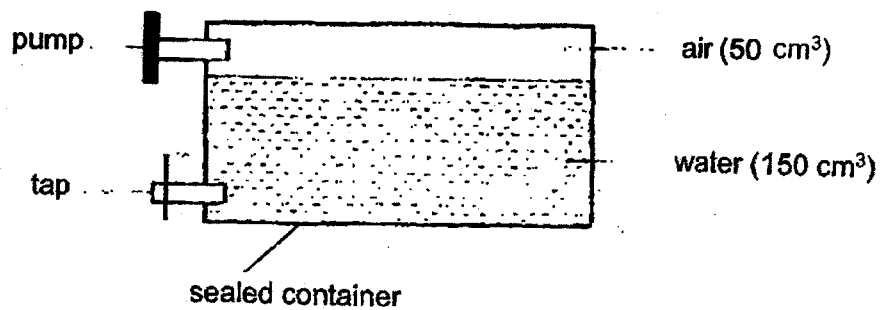

He used the tap to remove 20 cm³ of water.
He then used the pump to add 15 cm³ of air into the container.

- (b) What was the final volume of water and air in the container?
Explain using the properties of water and air for your answer.

[3]

	Final volume (cm ³)	Property	Explanation
Water			
Air			



35. A magnet is used to keep the lid of a bag closed.

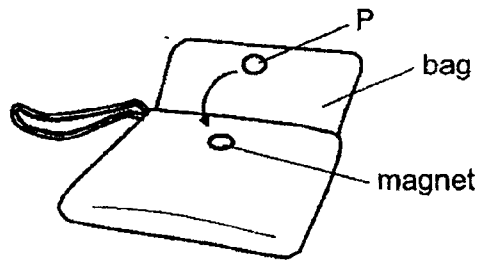

(a) Circle the correct answer below. [1]

A material that can be used to make P is (steel / plastic / wood).

(b) Fill in the blank below. [1]

The bag will not open easily because the magnet _____ P.

Linda had a bar magnet. She placed a pin at each point X, Y and Z. She replaced each pin with a heavier pin, until she found the heaviest pin that could be attached without dropping.

The result is as shown.

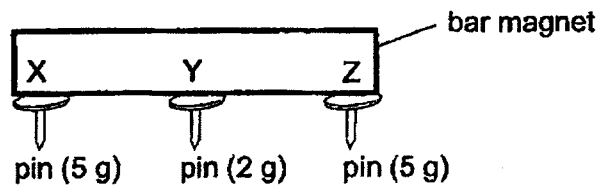

(c) What can she tell from the result of the experiment? [1]



36. Dinesh set up the experiment shown below.

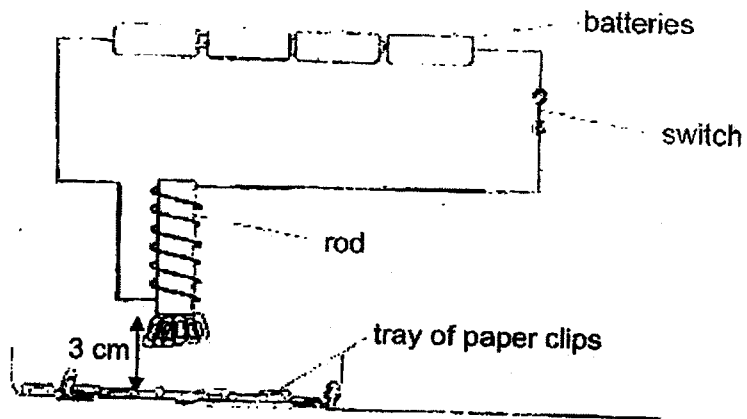

He placed the rod 3 cm from a tray of paper clips and counted the number of paper clips that were attracted to it.

He then reduced the number of batteries connected and recorded the number of paper clips that were attracted.

His results are shown below.

Number of batteries	Number of paper clips attracted
4	10
3	8
2	6
1	3

(a) What is the aim of his experiment?

[1]

(b) Without changing the number of batteries or the rod, write down two ways Dinesh can increase the number of paper clips attracted to the electromagnet. [2]

(i)

(ii)



37. Haijun conducts an experiment in a dark room to investigate how light travels.

- (a) Tick (✓) the box for the set-up which allows Haijun to see the candlelight when he looks through the hole at P. [1]

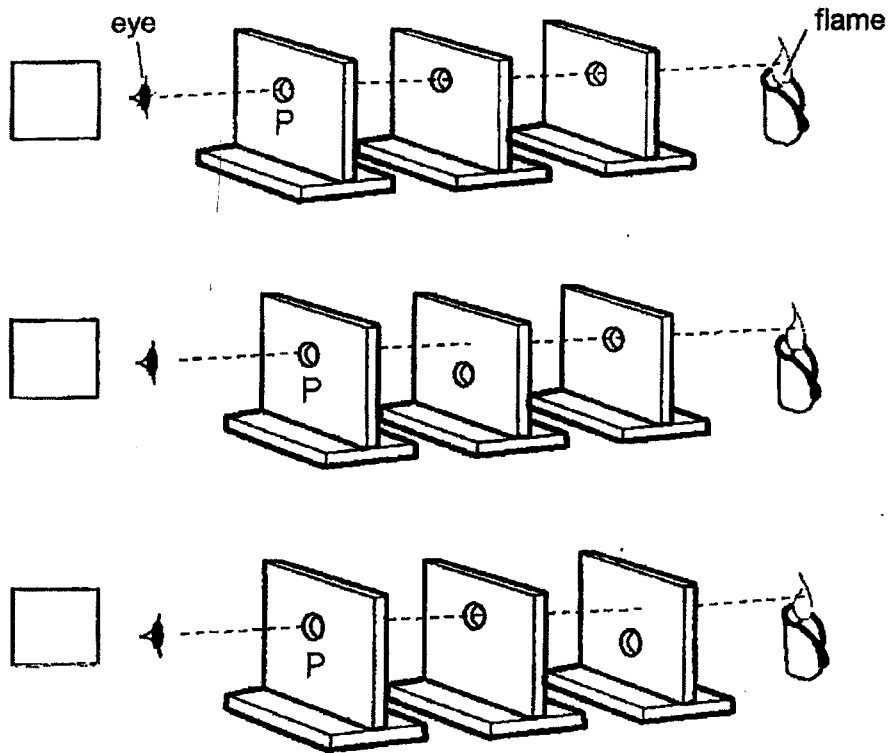

- (b) What can Haijun conclude about how light travels? [1]

- (c) Explain why Haijun cannot see the candle when the flame is blown off. [1]

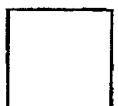

38. The diagram shows a beaker of water.



Fill in the blanks using the correct words in the box.

gas	decreases	solid
remains unchanged	increases	

- (a) When water loses heat, its temperature _____ [1]
- (b) The beaker of water is put in the freezer. After some time, the water will change its state to _____ [1]

Look at the diagram below.

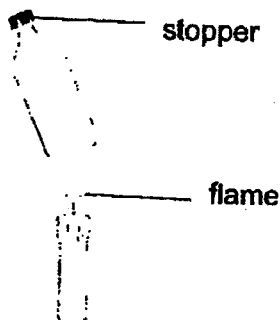

- (c) After the bottle was heated for a few minutes, the stopper popped out. Explain why this happened. [2]



39. Jenny conducted an experiment in a dark room. She shone a torch through liquid Q and recorded the amount of light passing through liquid Q using a light sensor connected to a data logger.

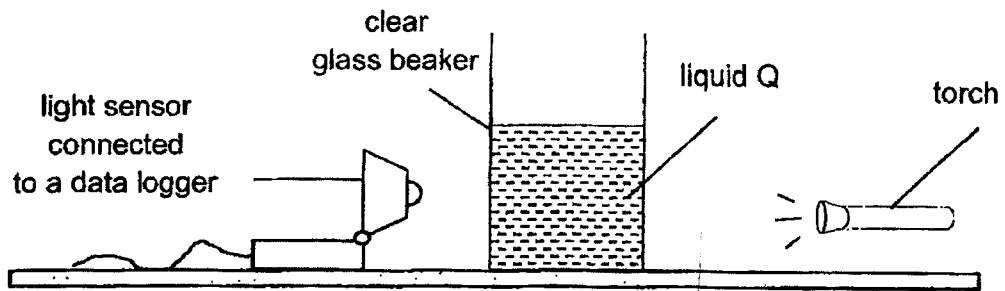

She repeated her experiment with liquids R, S and T. She recorded her observations in the graph below.

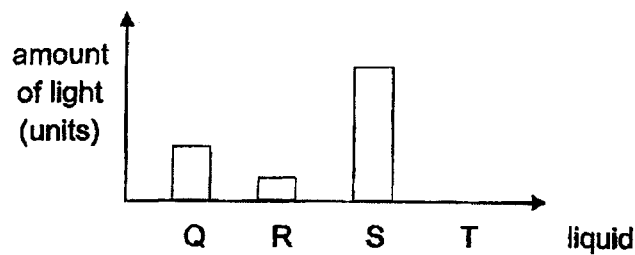

- (a) State one variable to be kept constant for this experiment to be a fair test. [1]

- (b) Explain why a clear glass beaker must be used for this experiment. [1]

Liquids Q, R, S and T are samples of seawater collected from different areas where people snorkel in.



- (c) Based on the graph on Pg 12, which liquid Q, R, S or T, is best for people to snorkel in so that they can see the marine animals clearly? Explain your answer. [2]



40. Some scoops of ice cream were placed in a metal cup and a paper cup as shown below.

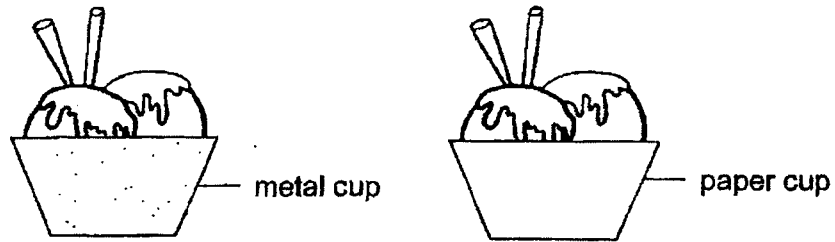

- (a) Explain why the metal cup feels cold to the hand when touched. [1]

- (b) In which cup will the ice cream melt slower? Explain. [2]

- (c) Marcus suggested some ways to keep the ice cream in the metal cup frozen for a longer time. Which of the following are correct? Tick (✓) the correct boxes. [1]

Action	Tick (✓) if correct
Place the cup in a basin filled with crushed ice.	
Wrap the cup with a towel.	
Place a metal spoon into the cup.	



41. Junxiong used the set-up shown below to study a certain property of material R. He increased the mass until string R broke and recorded the reading on the spring balance.

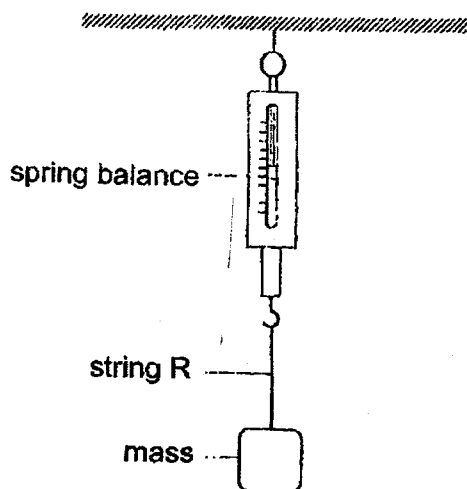

He repeated the experiment with material S. The results are shown below.

Material	Reading on spring balance when string broke (units)
R	45
S	8

- (a) Name the property of material Junxiong is testing.

[1]

- (b) Based on his results, which material R or S is more suitable to be used for the string to fly a big kite? Explain your answer.

[2]

END OF PAPER





SCHOOL : CHIJ PRIMARY SCHOOL
LEVEL : PRIMARY 4
SUBJECT : SCIENCE
TERM : SA2 2023

CONTACT :

Q1	Q2	Q3	Q4	Q5	Q6	Q7	Q8	Q9	Q10
4	4	2	1	4	2	1	4	3	2
Q11	Q12	Q13	Q14	Q15	Q16	Q17	Q18	Q19	Q20
4	2	3	4	3	2	3	4	2	1
Q21	Q22	Q23	Q24	Q25	Q26	Q27	Q28		
1	4	3	4	3	3	3	4		

Q29)	<p>a) The life cycle of the butterfly has 4-stages but the life cycle of the cockroach have 3-stages.</p> <p>b) To ensure the continuity if its own kind that at least some eggs will hatch and grow into adult to continue its life cycle even if some are eaten by predators or died.</p>
Q30)	<p>a)1,4,3,2,5</p> <p>b)Location 1: In the garden Location 2: In a dark room.</p>
Q31)	<p>a) To find out how the amount of water given for the bread affects the amount of mould grown.</p> <p>b) When the amount of water given increases, the amount of mould grown will increase.</p> <p>c) Living things need water to survive.</p>
Q32)	<p>a) scales</p> <p>b) hair</p> <p>c) feathers</p> <p>d) Yes, insects have six legs and three body parts but the animal does not have six legs and does not have 3 body parts.</p>

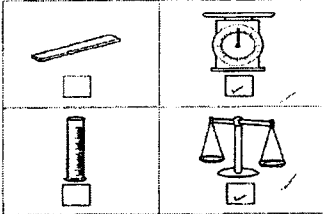
Q33)	<p>a) Matter is anything that has mass and occupies space.</p> <p>b)</p> 
Q34)	<p>a) There was air in the bottle. Water entered the bottle through the hole at point Q and pushed the air out. Air escaped through the hole at point P and water displaced the space previously occupied by the water. Thus, the bottle gained weight and sank.</p> <p>b)</p> <p>Water – 130cm³</p> <p>Property --- water has a definite volume.</p> <p>Explanation --- When 20cm³ of water was removed the volume of water decreased.</p> <p>Air --- 70cm³</p> <p>Property --- Air has no definite volume and will take the capacity of the container.</p> <p>Explanation --- Air in the container spreads out to occupy any available.</p>
Q35)	<p>a) steel</p> <p>b) attracting</p> <p>c) The magnetic strength of the magnet is the strongest at its two poles.</p>
Q36)	<p>a) To find out how the number of batteries connected affects the number of paper clips attracted.</p> <p>b) i)Coil more rounds of wire around the rod. ii)Move the rod for it to be closer to the paper clips.</p>

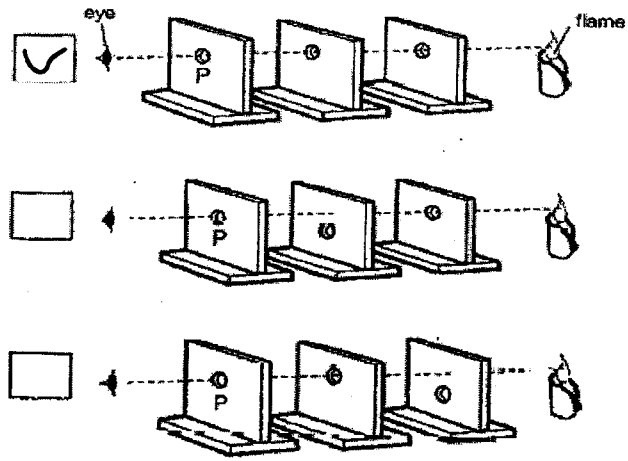
Q37)	<p>a)</p>  <p>b) Light travels in a straight line. c) No light will be reflected Haijun's eyes.</p>
Q38)	<p>a) decreases b) solid c) The air in the bottle gained heat from the flame and expanded to push the stopper out.</p>
Q39)	<p>a) The distance between the torch and the clear glass beaker. b) A clear glass will not block any light from the torch shining onto the liquid, so that the amount of liquid passed through the liquids can be measured. c) S, the amount of light detected by the light sensor is the greatest. S is the clearest. Marine animals can reflect the most amount of light into the eyes of the people snorkeling.</p>
Q40)	<p>a) The hand lost heat the metal cup. b) The paper cup, it will conduct heat from the surroundings to the ice cream slower as paper is a poorer conductor of heat than metal. Thus, the paper cup will gain heat from the surroundings slower. c) Place the cup in a basin filled with crushed ice. Wrap the cup with a towel</p>

Q41)	<p>a) Strength.</p> <p>b) Material R, it can hold more mass before it broke showing that it is stronger. The string to fly a bigger kite must not break easily so that we can control the kite when flying it.</p>
-------------	--