

**Ai Tong School
P4 Science
2024 Term 2 Review**

Name: _____ () Class: 4 _____

Date: _____ Marks: _____/30

Duration: 40 minutes

Parent's Signature: _____

Section A (18 marks)

For each question from 1 to 9, four options are given. One of them is the correct answer. Make your choice (1, 2, 3 or 4) and shade your answer on the Optical Answer Sheet.

- 1 The diagram below shows the human digestive system.

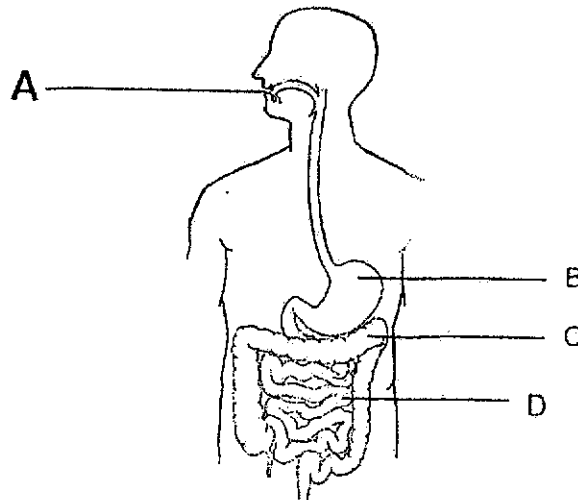

Which of the following statements is correct?

- (1) Digestion is completed in part C.
- (2) No digestion takes place in part A.
- (3) No digestive juice is found in part B.
- (4) Digested food is absorbed into the blood in part D.

()

(Go on to the next page)

2 Study the table below on human body systems.

Which of the following is correct?

	Body system	Organ	Function of organ
(1)	Skeletal	Brain	To protect our main organs.
(2)	Muscular	Muscles	To give our body its shape.
(3)	Circulatory	Heart	To pump blood to the rest of the body.
(4)	Respiratory	Blood	To transport waste materials away from different parts of the body.

()

3 A, B, C, D and E are organs in the digestive system. The graph below shows the amount of undigested food leaving each organ after a meal.

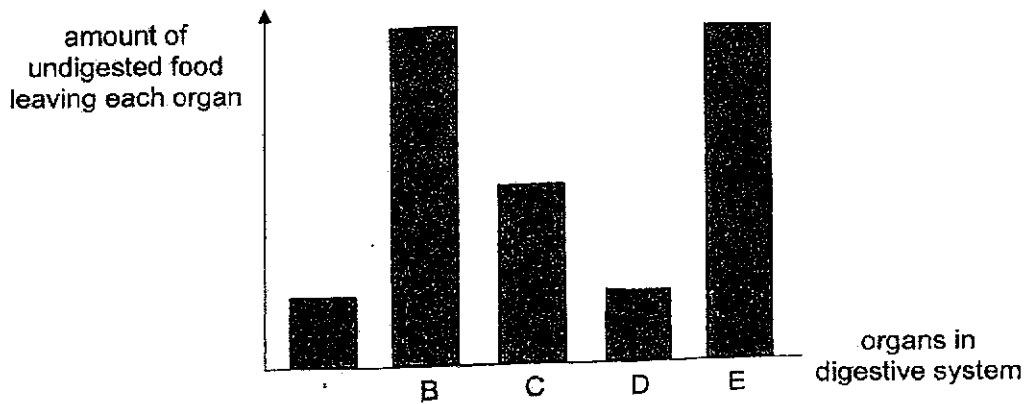

Which of the following is correct?

	Mouth	Gullet	Small Intestine	Large Intestine
(1)	A	D	B	E
(2)	B	C	D	A
(3)	E	B	C	D
(4)	B	E	A	D

()

(Go on to the next page)

- 4 Alex and Kaylyn made the following statements about substance X which is in a container.

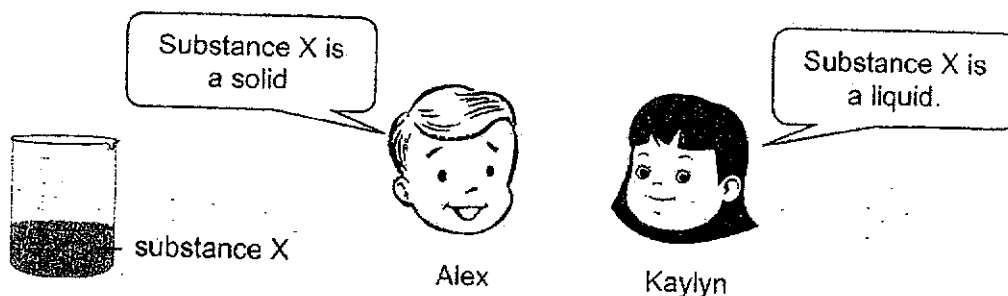

Which of the following tests can help determine which student is correct?

- (1) To find out if substance X has mass.
- (2) To find out if substance X can be compressed.
- (3) To find out if substance X has a definite shape.
- (4) To find out if substance X has a definite volume.

()

- 5 An experiment was set up as shown below using a sealed metal container which holds 60 cm^3 of water and 30 cm^3 of air. 10 cm^3 of water was removed from the container through the tap.

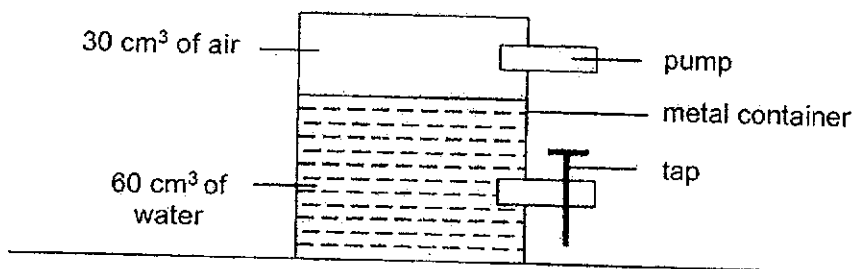

Which of the following correctly shows the amount of air in the container at the end of the experiment and the explanation of the results?

	Amount of air in container	Explanation of the results
(1)	30 cm^3	Air can be compressed.
(2)	30 cm^3	Air has no definite volume.
(3)	40 cm^3	Air can be compressed.
(4)	40 cm^3	Air has no definite volume.

()

(Go on to the next page)

- 6 The diagram below shows two objects, X and Y, placed on a beam balance.

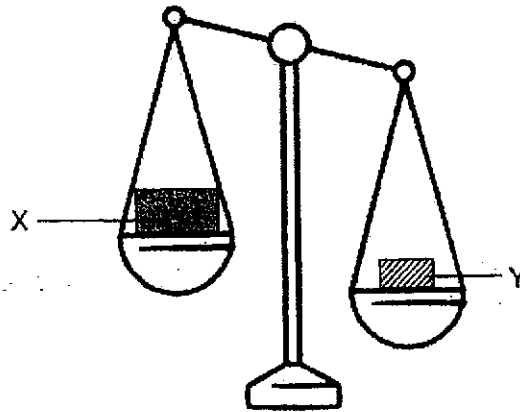

Based on the observation above, which statement is correct?

- (1) Y has a greater mass than X.
- (2) Y has a greater volume than X.
- (3) Both X and Y are made of the same material.
- (4) Objects with smaller mass, have smaller volume.

()

- 7 Which one of the following is a source of light?

(1)

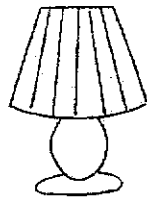

a lit lamp

(2)



a mirror

(3)

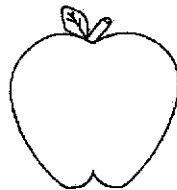

an apple

(4)



the moon

()

(Go on to the next page)

- 8 .Kaelyn conducted an experiment and realised that she can see light through the holes of the cardboards when they are aligned. However, when one of the cardboards is shifted slightly, she no longer sees the light.

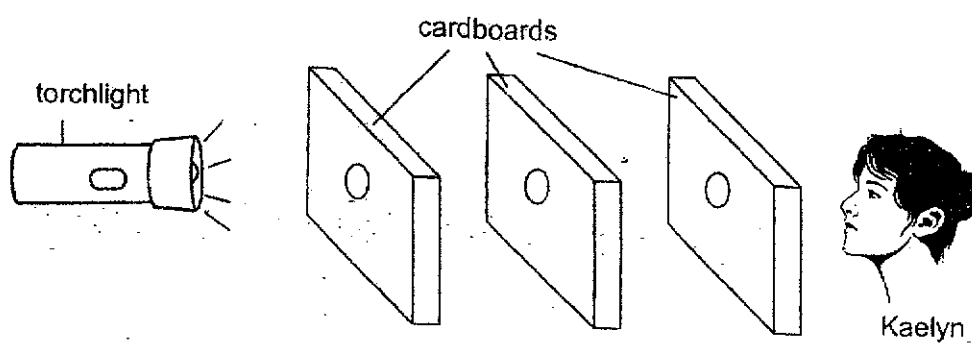

Which is the correct reason for her observation?

- (1) Light can be reflected.
- (2) Light cannot be blocked.
- (3) Light is a form of energy.
- (4) Light travels in a straight line.

(:)

(Go on to the next page)

9 Study the diagram below.

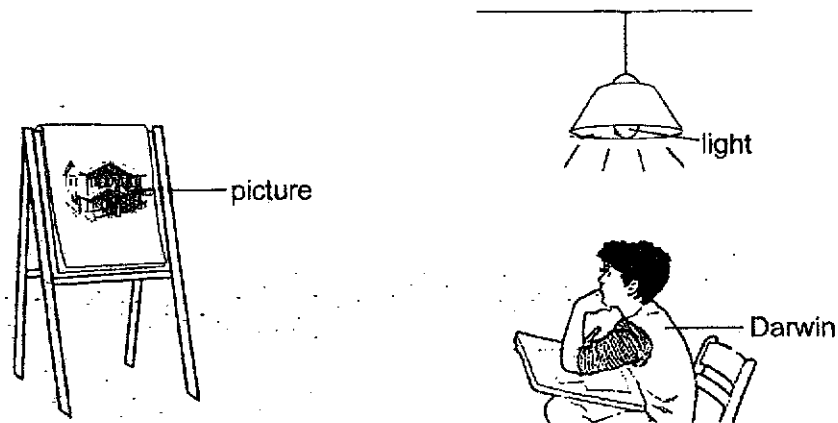

How is Darwin able to see the picture?

- (1) The picture gives off light and enters his eyes.
- (2) The light reflects the picture and enters his eyes.
- (3) The light enters his eyes and reflects on the picture.
- (4) The light falls on the picture and gets reflected into his eyes.

()

(Go on to the next page)

Section B (12 marks)

For questions 10 to 14, write your answers in the spaces provided.

The number of marks available is shown in bracket [] at the end of each question or part question.

- 10 Larry carried out an experiment to find out how the size of the food cube affects the time taken for it to be completely digested. Each set-up contains the same amount of digestive juices and the same amount of food.

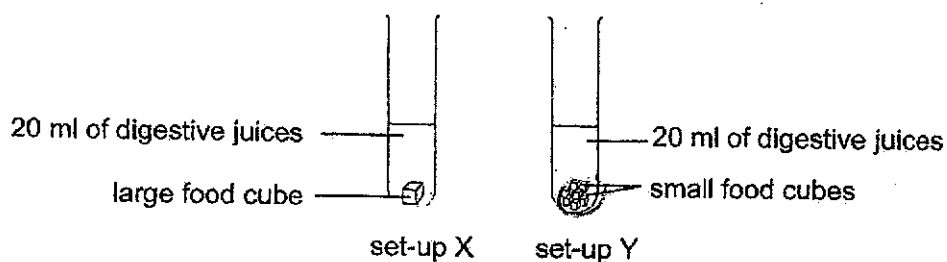

He recorded the time taken for the food to be completely digested in the table below.

Set-up	Size of food cube CV	Time taken for all the food to be completely digested in V
X	large	2 hours
Y	small	1 hour

- (a) What is the changed variable in this experiment? [1]
- _____
- (b) Based on the information given, what is the relationship between the time taken for all the food to be completely digested and the size of the food cube? [1]
- _____
- _____
- (c) Explain how chewing food helps to digest food faster. [1]
- _____
- _____

(Go on to the next page)

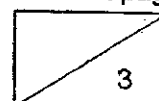

- 11 Alex and Ben are preparing for a shadow puppet show. Below are the items that have been provided to them to stage the puppet show.



satay sticks

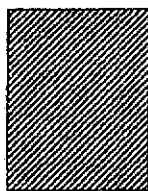

cardboard

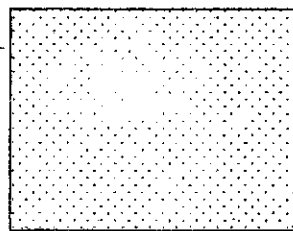

white cloth for the screen

- (a) They realise that one item is not provided. What is the item? [1]

- (b) Give a reason why the cardboard is used to make puppets. [1]

(Go on to the next page)

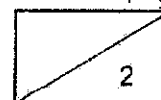

- 12 The diagram below shows a set-up used in a dark room to measure the amount of light that could pass through different materials, P, Q and R.

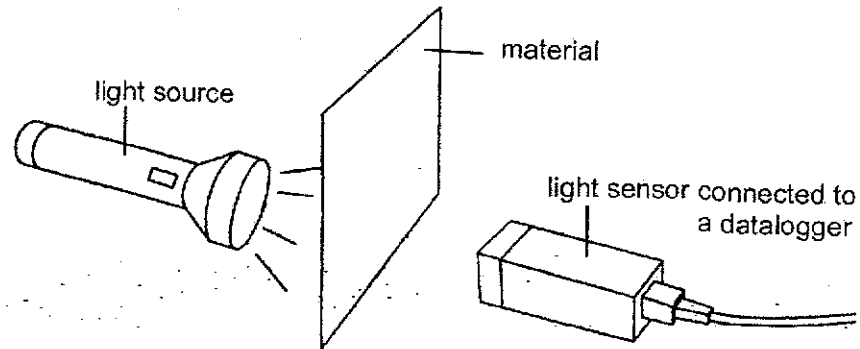

The table below shows the amount of light that passed through different materials, P, Q and R.

Material	Amount of light detected by the light sensor (units)
No material	100
P	0
Q	60
R	99

The picture below shows a pair of sunglasses.



- (a) Based on the results, which material P, Q or R, would be most suitable to make part M of the sunglasses? Explain your answer. [1]

- (b) What will happen to the amount of light that passes through if materials P and R are placed together? [1]

(Go on to the next page)

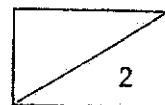

- 13 Derrick inverted two identical plastic cups, A and B, into a basin of water as shown in the diagram below. He pierced a hole at the base of one of the plastic cups.

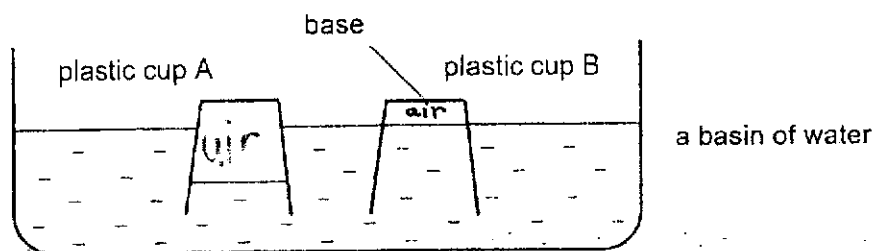

Based on the results shown above, which plastic cup, A or B, is more likely to have a hole at its base? Explain your answer. [2]

- 14 Mr Tan filled a container to the brim with marbles as shown in the diagram below. Next, he tried to pour some water into the container.

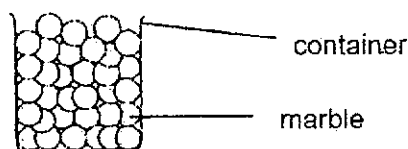

- (a) Explain why Mr Tan is able to pour water into the container even though the marbles were filled to the brim. [2]

- (b) Besides taking up space, state another property of liquid, which enables the water to be poured into the container of marbles. [1]

End of Paper

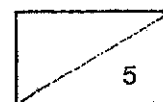

1)4 2)3 3)4 4)3 5)4 6)1 7)1 8)4 9)4

Term 2 Science WA Correction Template

Name: _____ () Date: _____

Class: _____

Questions	Answer
Q10a	<u>size</u> of food
Q10b	As the size of the food <u>increases</u> , the time taken for all the food to be completely digested <u>increases</u>
Q10c	Chewing <u>increases</u> the <u>surface area</u> of the food in contact with <u>digestive juice</u> for faster digestion.
Q11a	Light source
Q11b	Cardboard is <u>opaque</u> / does <u>not</u> allow light to pass through.
Q12a	Choice : Q. Data: Material Q is <u>translucent</u> / allows <u>some</u> light to pass through.
Q12b	<u>No</u> light can pass through.
Q13	Choice: Plastic cup <u>B</u> Data: The water level in plastic cup B is <u>same</u> as the basin of water. Explain: Some of the <u>air</u> in plastic cup B has <u>escape</u> through the hole.

Q14a	There are <u>air spaces / air gaps</u> in between the marbles. Air in between the space <u>escape</u> and water takes up the <u>space</u> .
Q14b	Liquid has <u>no</u> definite shape.