

MARIS STELLA HIGH SCHOOL (PRIMARY)

SA2 EXAMINATION

SCIENCE

28 OCTOBER 2021

BOOKLET A

NAME: _____ ()

CLASS: Primary 5 (A)

28 questions

56 marks

Total Time for Booklets A & B: 1 h 45 min

DO NOT OPEN THIS BOOKLET UNTIL YOU ARE TOLD TO DO SO.

FOLLOW ALL INSTRUCTIONS CAREFULLY.

For each question from 1 to 28, four options are given. One of them is the correct answer. Make your choice (1, 2, 3 or 4). Shade the correct oval (1, 2, 3 or 4) on the Optical Answer Sheet (OAS).
(28 x 2 marks)

- 1 The pictures below show two animals.

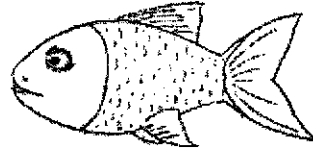

How are the animals similar?

- (1) Both lay eggs.
 (2) Both have scales.
 (3) Both have moist skin.
 (4) Both give birth to young.
- 2 The diagram below shows the life cycle of Animal W.

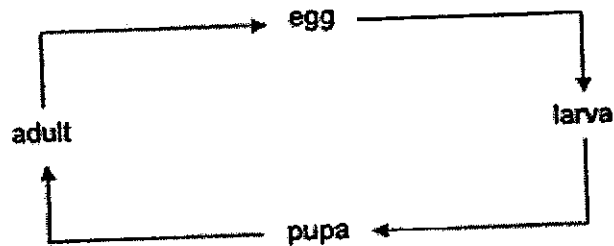

Which of the following statements is/are correct about Animal W?

- A Animal W is a frog.
 B The life cycle of Animal W has four stages.
 C The young of Animal W looks different from its parents.
- (1) A only
 (2) B only
 (3) C only
 (4) B and C only

3 Study the chart below.

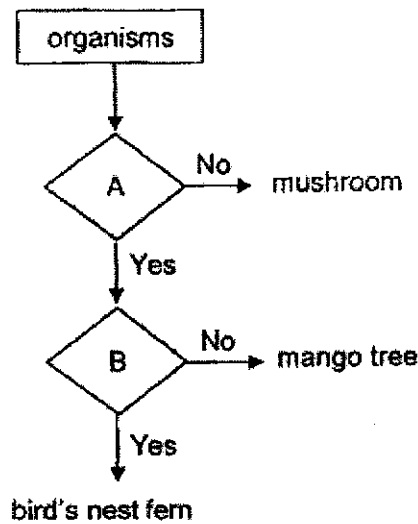

Which of the following is correct?

Characteristics		
	A	B
(1)	Does it reproduce from seeds?	Does it reproduce from spores?
(2)	Does it reproduce from seeds?	Does it make its own food?
(3)	Does it make its own food?	Does it reproduce from seeds?
(4)	Does it make its own food?	Does it reproduce from spores?

4 Study the diagram of a plant below.

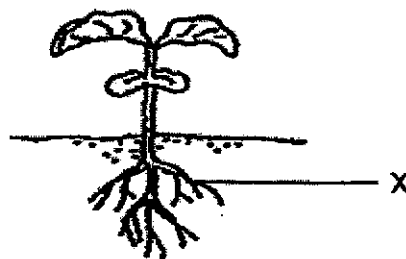

What is the function of X ?

- (1) to hold the plant upright
- (2) to make food for the plant
- (3) to take in water for the plant
- (4) to take in gases for the plant

- 5 The diagram shows how substances are transported in a plant. P and Q represent different parts of the plant. The arrows represent the movement of substances X and Y.

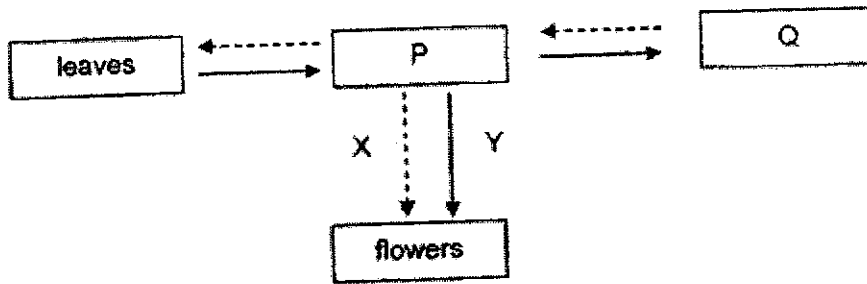

Which of the following is correct?

	P	Q	X	Y
(1)	roots	stem	food	water
(2)	stem	roots	food	water
(3)	roots	stem	water	food
(4)	stem	roots	water	food

- 6 The table shows some of the gases in air that are taken in and given out by a human.

Gas	Air taken in (%)	Air given out (%)
nitrogen	78	78
oxygen	21	16
carbon dioxide	less than 1	4
water vapour	less than 1	2

Based on the information given, which statement is correct?

- (1) Water is lost through breathing.
- (2) Nitrogen is absorbed into the blood.
- (3) The air given out has more carbon dioxide than oxygen.
- (4) All the oxygen that enters the lungs is absorbed into the bloodstream.

- 7 The diagrams below show Susie doing two different activities.

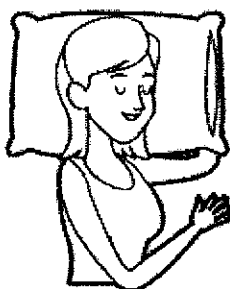

Which of the following correctly shows Susie's heart rate for each activity?

Susie's heart rate (beats per minute)		
	sleeping	playing tennis
(1)	62	62
(2)	62	145
(3)	145	62
(4)	145	145

- 8 The picture below shows Umar running. Carbon dioxide is produced as a waste product in his leg muscles as he runs.

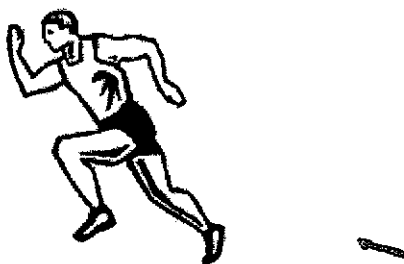

Which of the following correctly shows the movement of carbon dioxide from his leg muscles to his nose?

- (1) leg muscle cells → bloodstream → windpipe → lungs → nose
 (2) leg muscle cells → windpipe → lungs → bloodstream → nose
 (3) leg muscle cells → bloodstream → lungs → windpipe → nose
 (4) leg muscle cells → windpipe → bloodstream → lungs → nose

- 9 The diagram below shows cell Y.

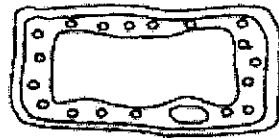

In which of the following part(s) can cell Y be taken from?

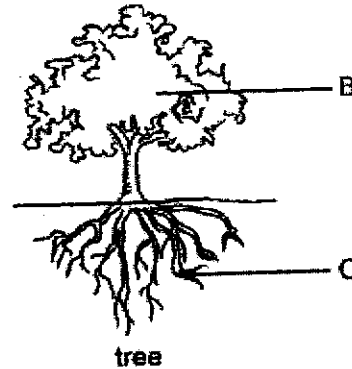
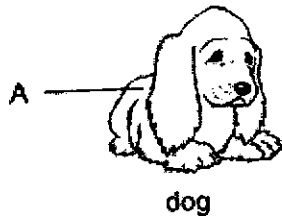

- (1) A only
 (2) B only
 (3) C only
 (4) B and C only
- 10 Organism A is a single-celled organism which has a cap and a nucleus at its base. The diagram below shows what happens to organism A after it is cut into two halves. After a few days, the upper half of the organism with the cap dried up and the lower half continued to grow to form a new cap.

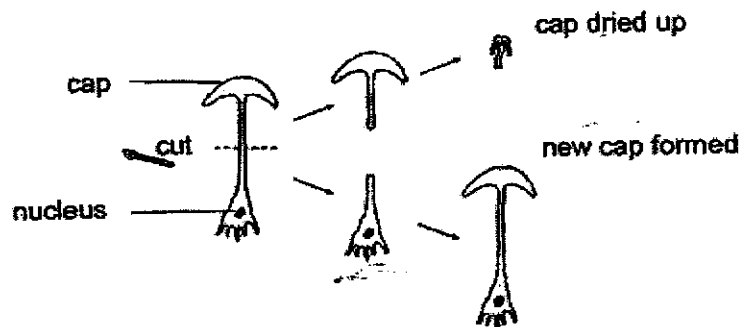

Based on the observation made, what can you conclude about the function of the nucleus?

- (1) It gives the organism its regular shape.
 (2) It allows some substances to enter the cell.
 (3) It contains genetic information of the organism.
 (4) It contains a jelly-like substance where activities within the cell take place.

- 11 The diagram below shows flowers A, B, C and D from the same plant. Flowers B, C and D had some parts removed as shown.

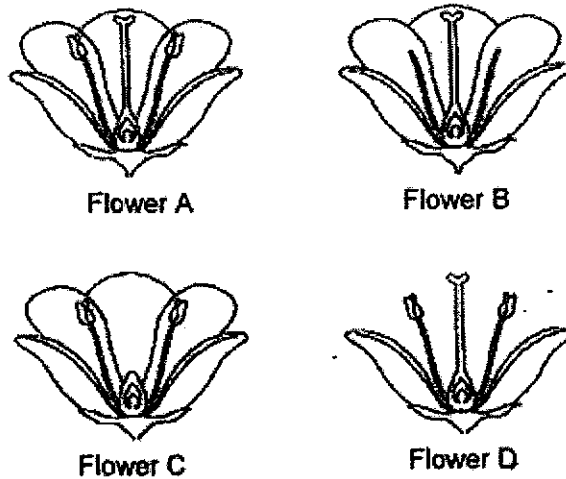

Which flower(s) can possibly develop into a fruit?

- (1) A only
 - (2) A and B only
 - (3) B and C only
 - (4) A, B and D only
- 12 The diagram below shows the male and female reproductive system in humans.

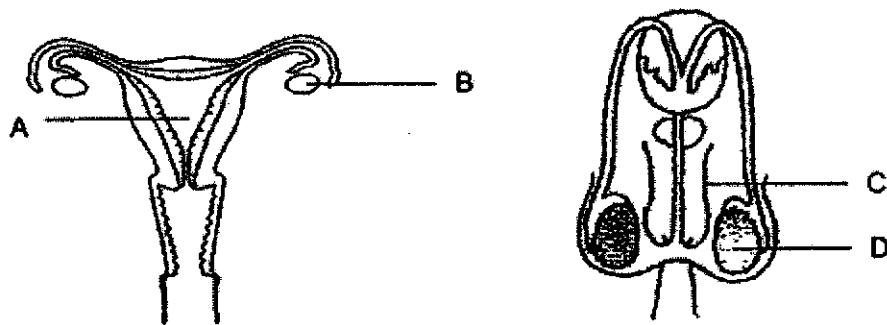

Which parts have the same function?

- (1) A and C
- (2) A and D
- (3) B and C
- (4) B and D

13 Which of the following statements is true about human reproduction?

- (1) The penis produces sperms.
- (2) The ovaries produce fertilised eggs.
- (3) The fertilised egg develops in the ovary.
- (4) The fertilised egg develops in the womb.

14 A plant had its outer ring of stem removed. After a few days, the stem of the plant was swollen at the part above the cut as shown in the diagram below.

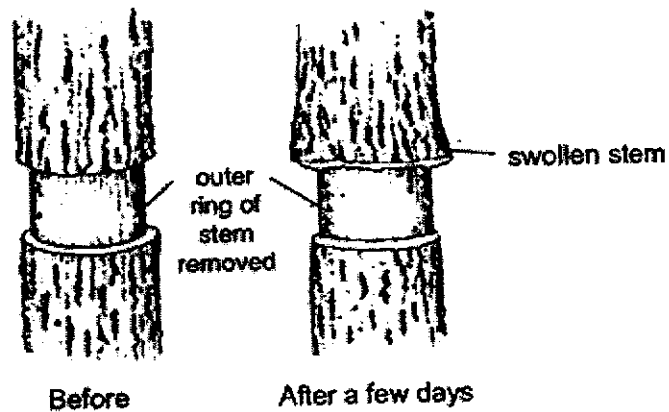

Which of the following explains why the swelling of the stem?

- (1) The water-carrying tubes were not removed so water accumulated at the part above the cut.
- (2) The water-carrying tubes were removed so water could not be transported to the part above the cut.
- (3) The food-carrying tubes were removed so food could not be transported to the part below the cut.
- (4) The food-carrying tubes were not removed so the plant was still able to transport food to all parts of the plant.

- 15 Devi conducted an experiment as shown below to investigate how the amount of light affects a process in plants. She kept all the variables constant except for the distance between the beaker and the lamp. She counted the number of bubbles produced per minute by the water plant for each of the different distance investigated.

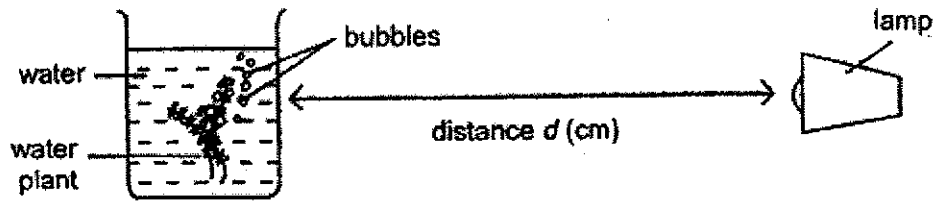

Which one of the following graphs is most likely the results of her investigation?

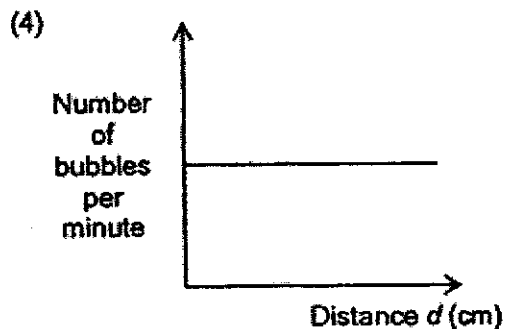
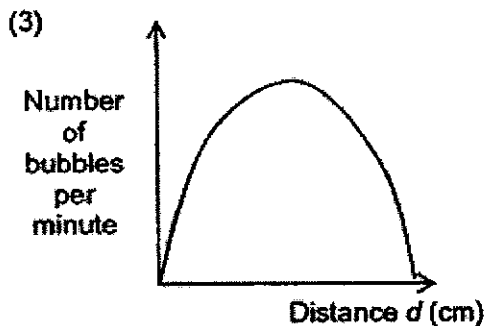
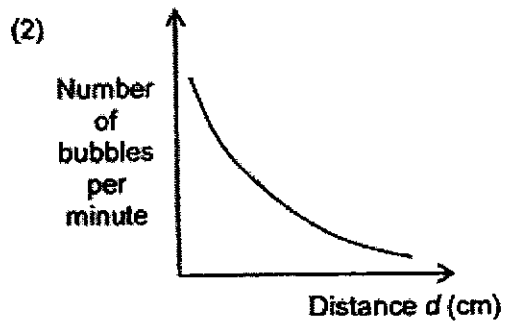
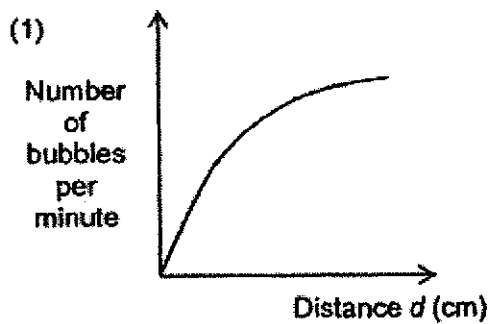

- 16 The diagram shows John using an exercise band for stretching exercises.

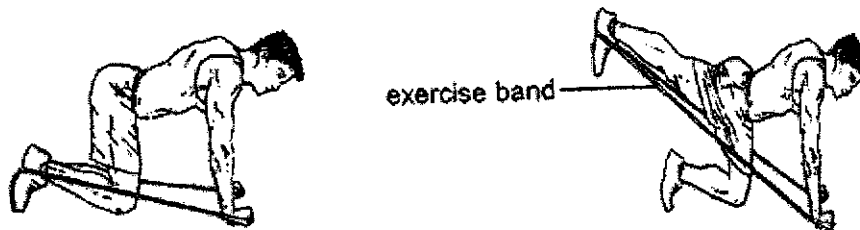

Which properties of the exercise band make it suitable for stretching exercises?

- (1) strength and flexibility
 - (2) flexible and waterproof
 - (3) strength and waterproof
 - (4) strength and ability to float on water
- 17 The diagram below shows a piece of plasticine that has been moulded.

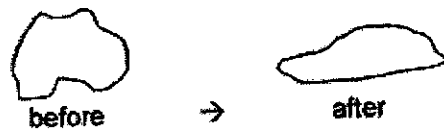

Based on the above observation, which of the following statements is/are correct?

- A Plasticine has a definite volume.
 - B Plasticine does not have a definite shape.
 - C Plasticine does not have a definite volume.
- (1) A only
 - (2) B only
 - (3) C only
 - (4) A and B only

- 18 The diagram below shows an electrical system that is used to raise a road barrier.

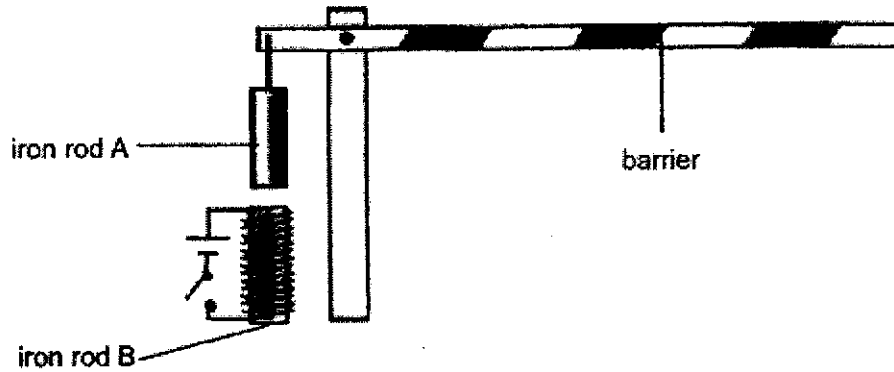

What can you do in order to raise a heavier barrier?

- (1) add more batteries in series
- (2) change iron rod B to a glass rod
- (3) change iron rod A to a plastic rod
- (4) coil fewer wires around iron rod B

- 19 Which beaker of water contains the most heat?

(1)

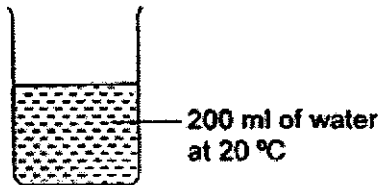

(2)

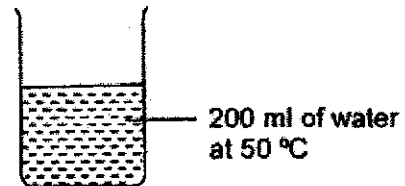

(3)

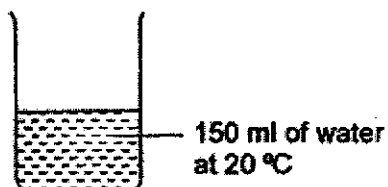

(4)

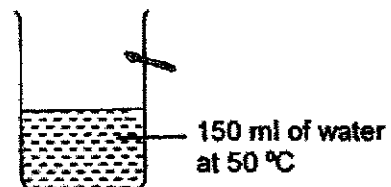

20 The diagram below shows light shining on a cuboid in a dark room from two different positions.

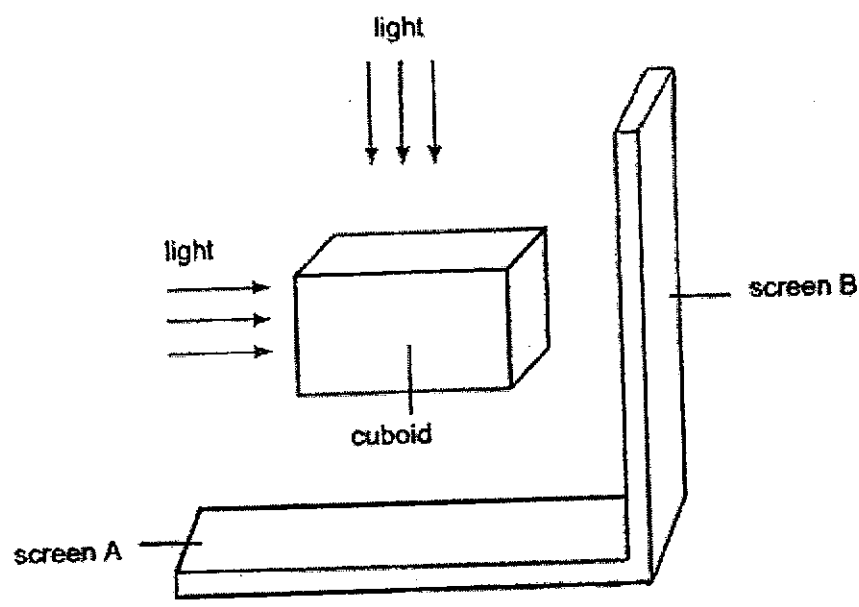

Which of the following correctly shows the shapes of the shadows formed on screens A and B?

	Screen A	Screen B
(1)		
(2)		
(3)		
(4)		

21 An experiment was conducted to find out if the number of times a steel nail was stroked affects the magnetism of the steel nail. The table below shows the results of the experiment.

Number of times the steel nail was stroked	Number of paperclips attracted to the magnetised steel nail
10	3
20	5
30	10

Which of the following shows the results of the experiment?

(1) number of paperclips attracted

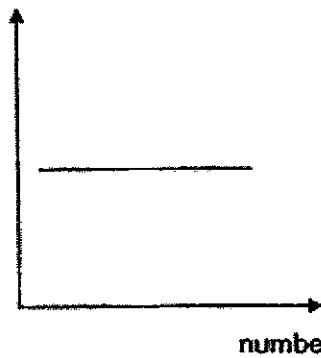

(2) number of paperclips attracted

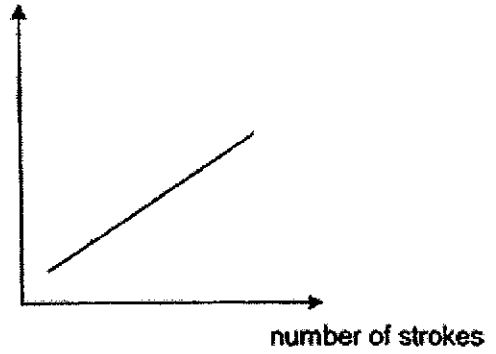

(3) number of paperclips attracted

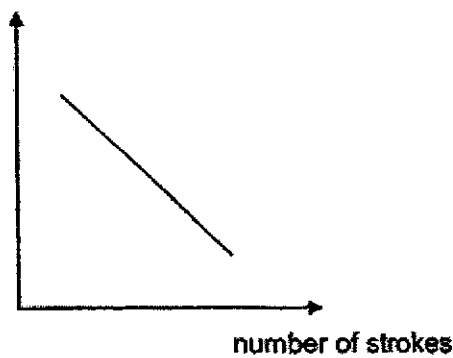

(4) number of paperclips attracted

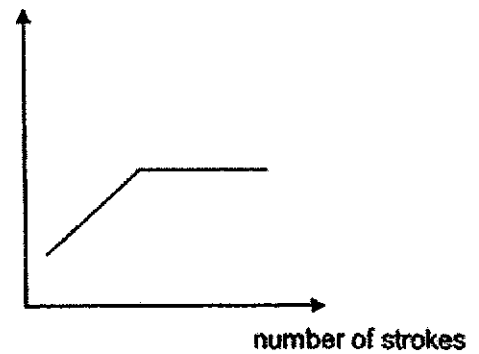

22 The diagram below represents the changes of state of water.

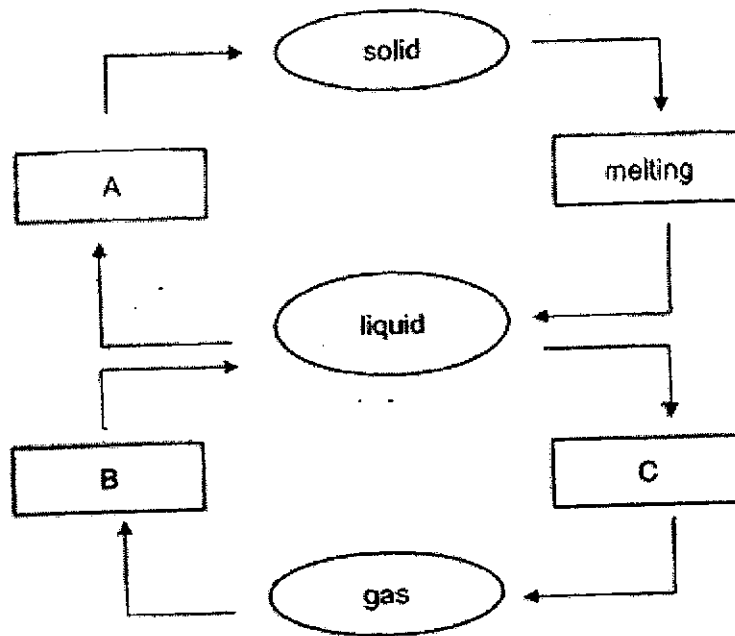

Which one of the following correctly represents A, B and C?

	A	B	C
(1)	freezing	condensation	evaporation
(2)	condensation	freezing	evaporation
(3)	freezing	evaporation	condensation
(4)	condensation	evaporation	freezing

23 In a wooden box, objects P and Q are placed touching each other. Heat flows from P to Q.

Which statement explains why heat flows from P to Q?

- (1) P has more mass than Q.
- (2) P is at a higher position than Q.
- (3) P has a higher temperature than Q.
- (4) P is a better conductor of heat than Q.

24 The diagram shows four different set-ups placed in a room at 30 °C.

Which set-up would have water droplets forming on the underside of the cover?

(1)

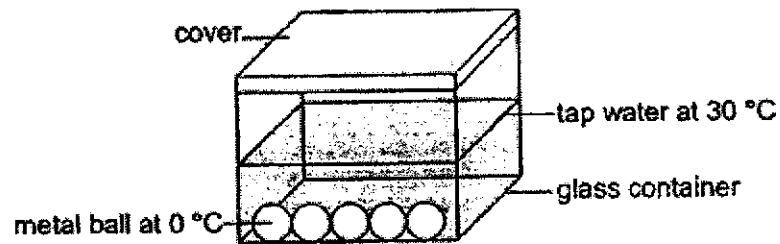

(2)

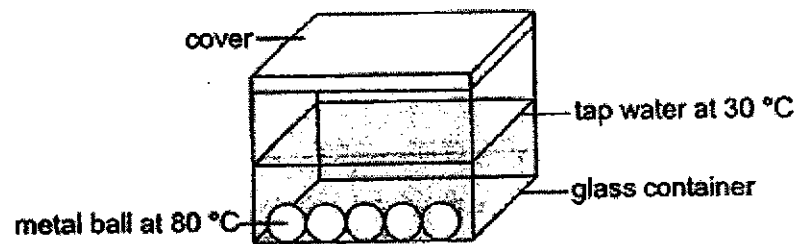

(3)

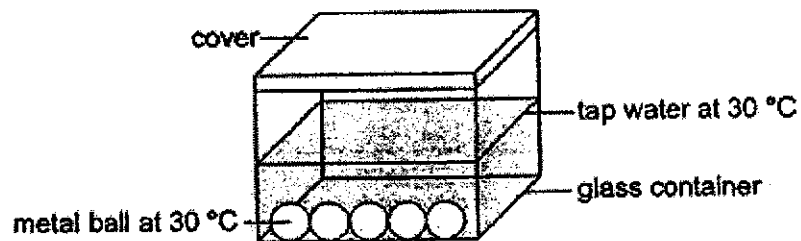

(4)

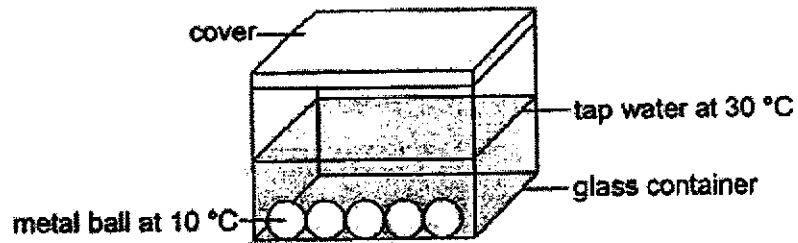

- 25 The table below shows the melting and boiling points of two substances, M and N.

Substance	Melting point (°C)	Boiling point (°C)
M	40	200
N	110	180

At which temperature are substances M and N in different states?

- (1) 0 °C
 (2) 28 °C
 (3) 95 °C
 (4) 220 °C
- 26 Su Fen conducted an experiment using the set-up shown below and measured the brightness of bulb X.

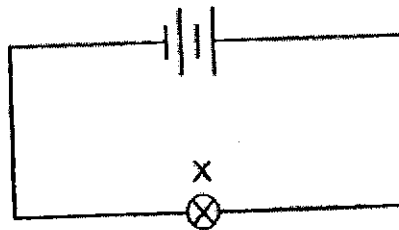

Su Fen connected another identical bulb, bulb Y, to the circuit above. She observed that the brightness of bulb X remained the same after bulb Y was added to the circuit.

Which of the following statements is correct about the circuit containing bulbs X and Y?

- (1) There is only one path for the current to flow.
 (2) When one bulb fuses, the other bulb cannot light up.
 (3) Adding one battery in series to the circuit does not affect the brightness of bulb X.
 (4) Switches can be added to the set-up such that each bulb can individually be turned on and off.

- 27 Study the circuit below. The batteries and bulbs are all working properly.

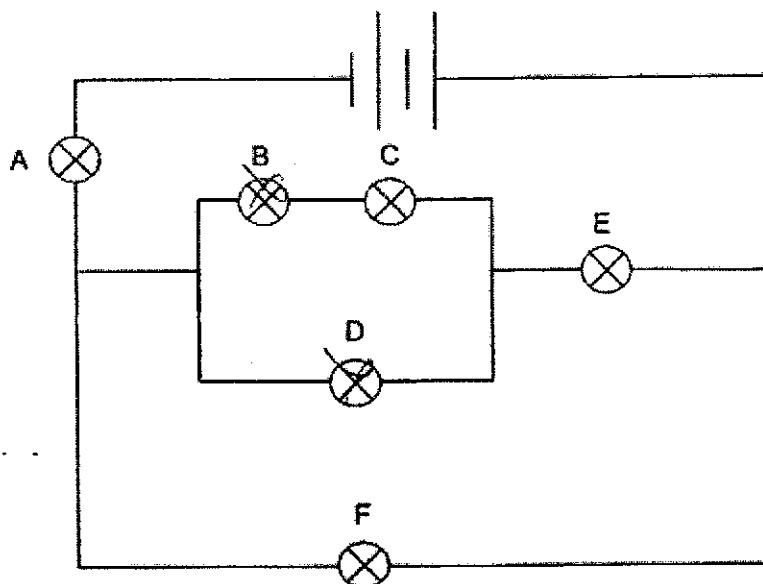

Which one of the following correctly states the number of bulb(s) that would still be lit when one or more bulbs is/are fused?

	Bulb(s) that is/are fused	Number of bulb(s) still lit
(1)	A	1
(2)	C	3
(3)	B and D	2
(4)	E and F	4

28 A circuit card is shown in the diagram below.

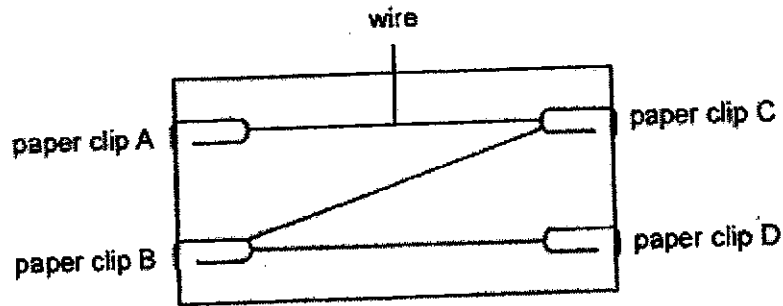

A circuit tester is then connected to different parts of paper clips, and the bulb in the circuit tester is observed. The table below shows the observations.

Pair of paper clips tested	Does the bulb light up?
A and B	No
A and C	No
B and C	Yes
B and D	Yes
C and D	Yes

Which of the paper clips are likely to be made of electrical conductors?

- (1) A and B only
- (2) C and D only
- (3) A, C and D only
- (4) B, C and D only



END OF BOOKLET A

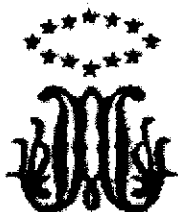

MARIS STELLA HIGH SCHOOL (PRIMARY)
SA2 EXAMINATION
SCIENCE
28 OCTOBER 2021

BOOKLET B

NAME: _____ ()

CLASS: Primary 5 ()

13 questions

44 marks

Total Time for Booklets A & B: 1 h 45 min

DO NOT OPEN THIS BOOKLET UNTIL YOU ARE TOLD TO DO SO.

FOLLOW ALL INSTRUCTIONS CAREFULLY.

Booklet A: _____ / 56

Booklet B: _____ / 44

Grand Total: _____ / 100

For questions 29 to 41, write your answers in this booklet. The number of marks available is shown in brackets [] at the end of each question or part question.

- 29 Ajay carried out an experiment as shown below. He left the two set-ups by the window. After two weeks, the seeds in set-up 1 germinated but the seeds in set-up 2 did not.

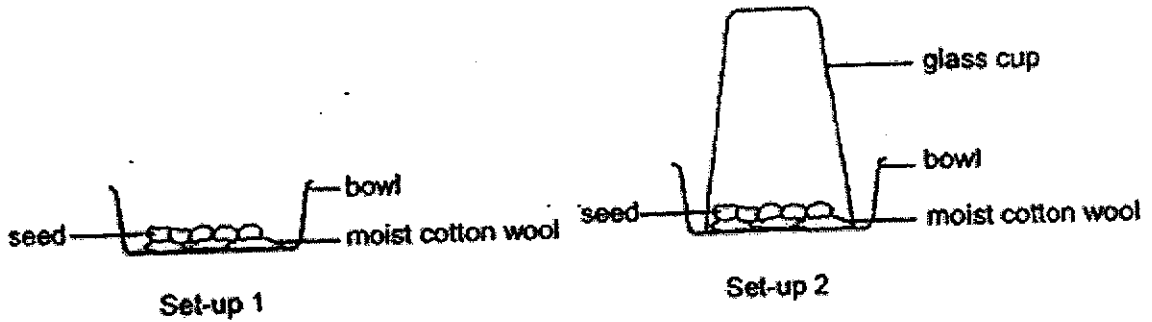

- (a) Explain why the seeds in set-up 2 did not germinate. [1]

- (b) Would the seeds in set-up 1 germinate if set-up 1 was placed in a cupboard? Give a reason for your answer. [1]

	2
--	---

(Go on to the next page)

- 30 (a) Complete the diagram below by drawing four arrows to show the circulation of blood in human. [1]

Use \longrightarrow for blood rich in oxygen and \dashrightarrow for blood poor in oxygen

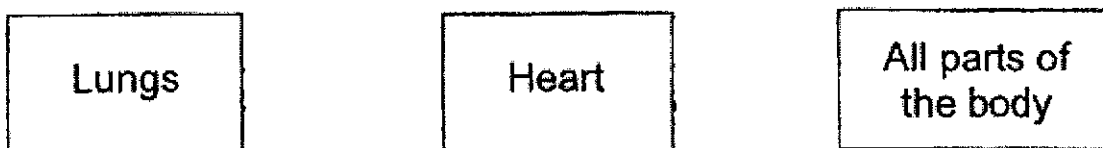

- (b) The graph below shows how the amount of oxygen taken in by the body per breath changes with a person's lung capacity. Lung capacity is the maximum volume of air a person can breathe into his/her lungs.

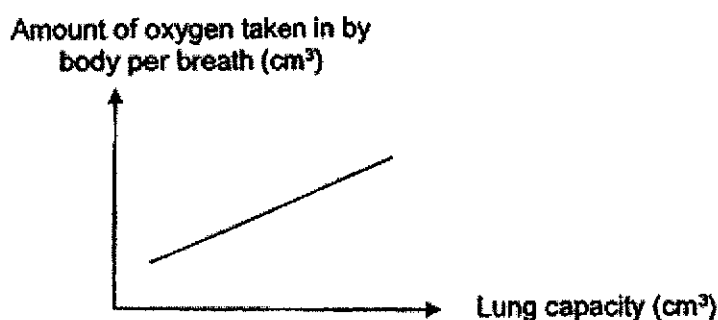

- (i) Based on the graph above, explain why a person with a larger lung capacity has a lower breathing rate. [2]

- (ii) Which other body system works together with the respiratory and circulatory system to provide us with energy? [1]

	4
--	---

- 31 The diagram shows the magnified view of tiny openings found on a leaf. Some of the gases that move through the tiny opening are oxygen, carbon dioxide and water vapour.

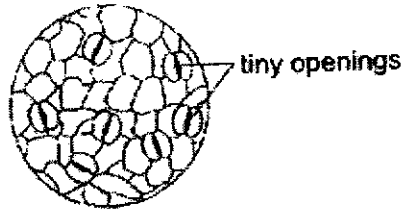

The graph below shows the changes in the size of the tiny openings of a plant at different times of the day.

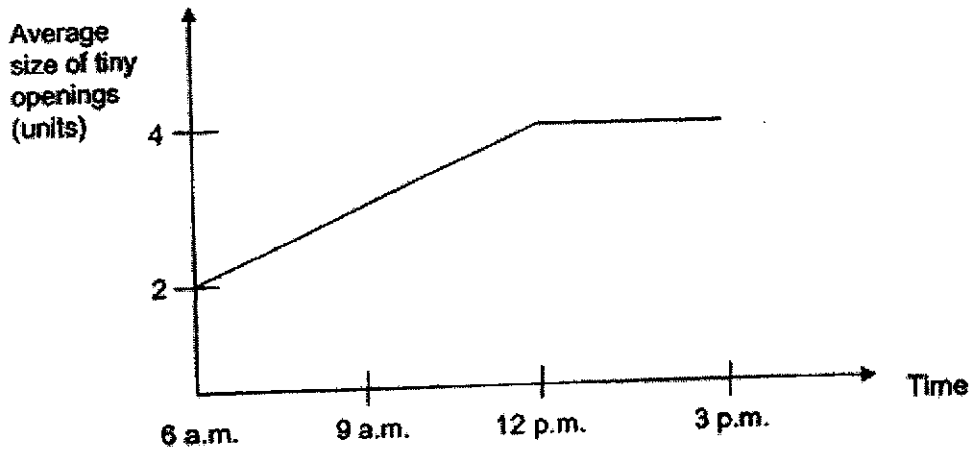

- (a) Based on his results, describe the changes in the size of the tiny openings from 6 a.m. to 3 p.m. [2]

- (b) How do larger tiny openings help in photosynthesis? [1]

- (c) State how larger tiny openings can be a disadvantage to the plant. [1]

	4
--	---

(Go on to the next page)

32 Study the flowchart below.

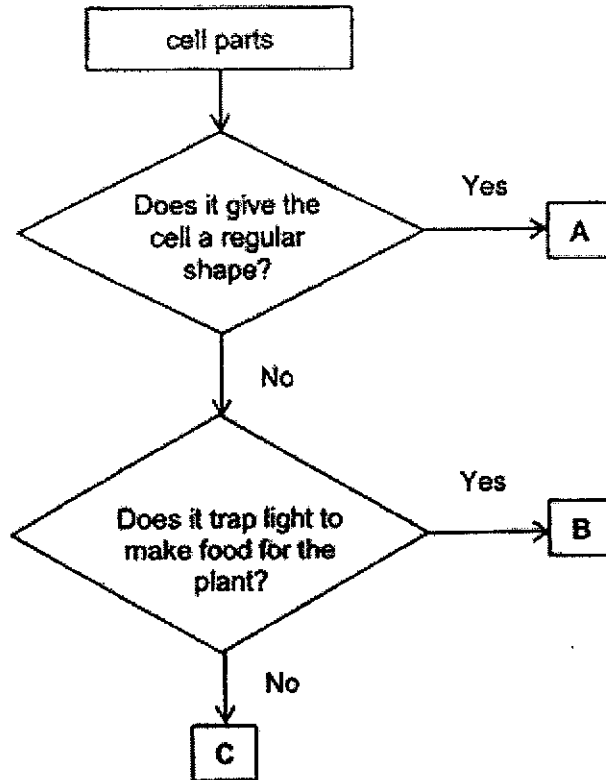

(a) Which cell part, A, B or C, is found in both plant and animal cells? [1]

(b) Study the cell below. Based on the flowchart, label the cell with cell parts A, B or C. [1]

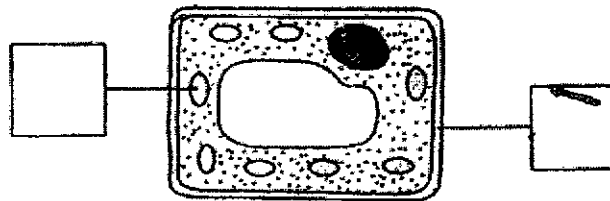

(c) Based on the flowchart, state a difference between cell parts A and C. [1]

	3
--	---

(Go on to the next page)

33 An experiment was carried out on three different plants, A and B. The table below shows the number of seedlings found at different distances from the parent plant after a few weeks.

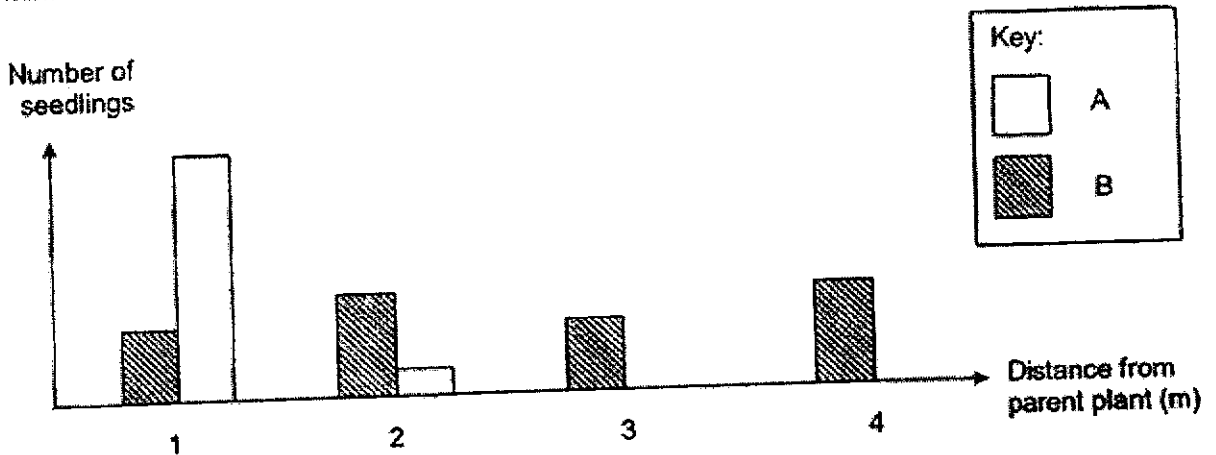

(a) The fruits of plants A and B are dispersed by animal or splitting. Identify the method of dispersal for the fruits of plants A and B. [1]

By animal: Fruit _____ By splitting: Fruit _____

(b) State one advantage of the method of dispersal of plant A. [1]

(c) Each of the fruits below comes from one of the plants above. Identify the plant, A or B, in which the fruits come from by writing letters A and B in the boxes. [1]



(d) Plant C reproduces by a different method from plants A and B.

(i) How does plant C reproduce? [1]

(ii) Name the plant group plant C belong to. [1]

	5
--	---

(Go on to the next page)

- 34 Vera set up the following experiment in a dark room. She used a tank divided into three sections K, L and M, by black plastic sheets as shown in the diagram below. The coloured lights were of the same brightness. Each section had a water plant with green leaves.

After some time, she observed bubbles in sections K and M only.

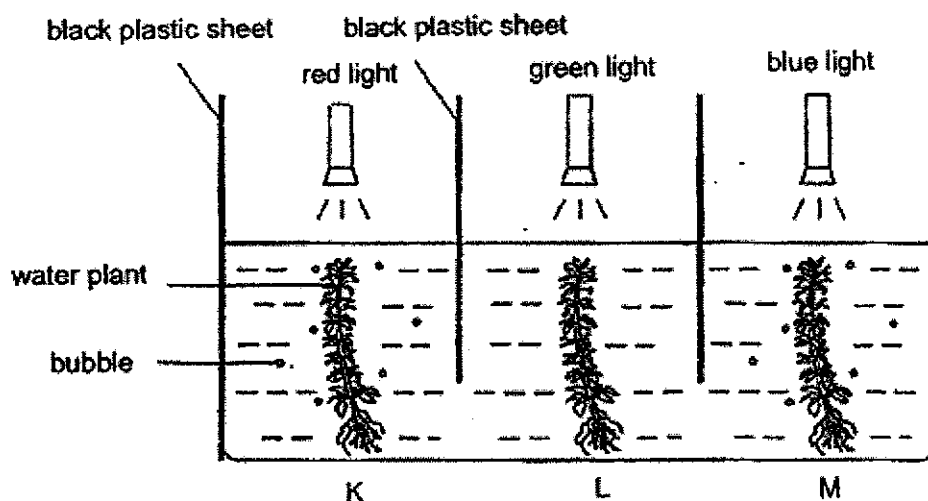

- (a) State the variable that is changed in Vera's experiment. [1]

- (b) Vera wants to set up a fish aquarium with the same water plants. Which coloured light, red, green or blue, should she use to for her aquarium to ensure that the fishes survive? [1]

- (c) Explain your answer in (b). [1]

	3
--	---

- 35 Tom wanted to test the property of three materials, A, B and C. He placed identical loads, one at a time, on each material until the material broke.

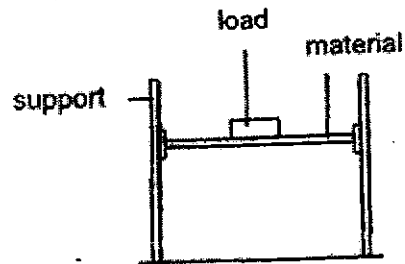

Tom recorded the total mass of the loads that each material could hold before it broke and recorded the results in the graph below.

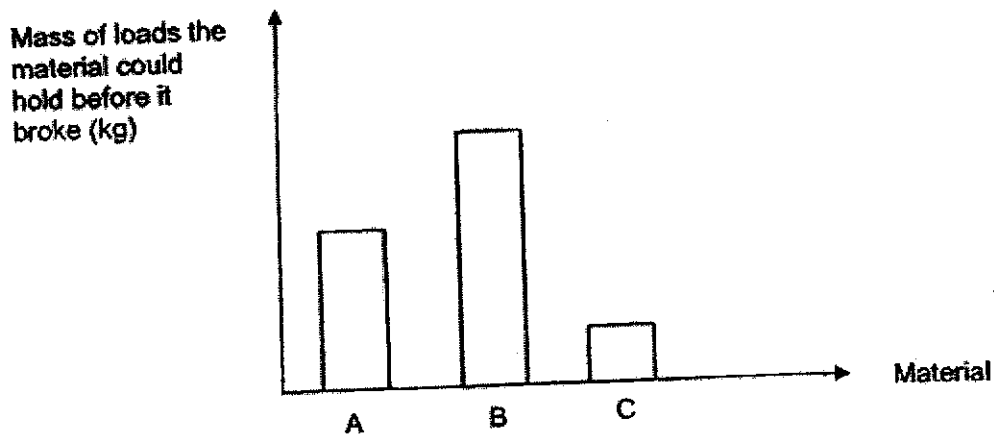

- (a) What property of material was Tom testing? [1]

- (b) Based on the graph, conclude the property of materials A, B and C. [1]



(Go on to the next page)

36 Kumar conducted the experiment shown below.

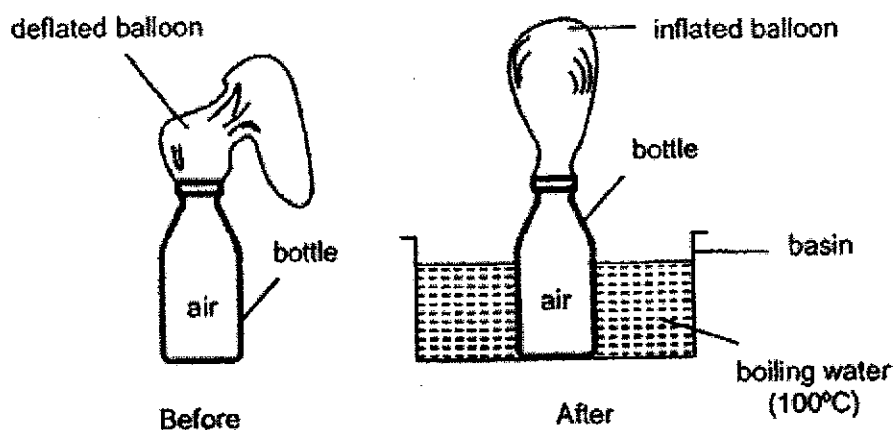

- (a) Kumar observed that the balloon inflated when the bottle is placed in boiling water. Explain his observation. [1]

- (b) Would the size of the balloon be bigger, smaller or the same if Kumar had used water at 60°C instead? [1]

- (c) Kumar had a glass with thick walls as shown.

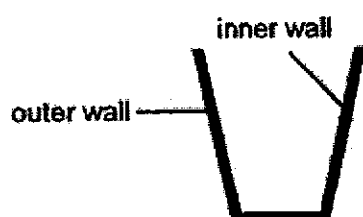

- When he filled the glass with boiling water, the glass cracked. Explain why. [1]

	3
--	---

37(a) Gerald used a spring balance to measure the mass a block as shown.

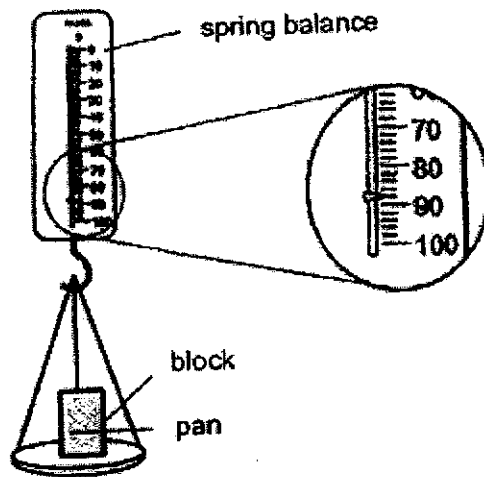

(i) State the reading shown in the diagram below.

[1]

Reading: _____ 9

Gerald then hung another identical block on the spring balance as shown.

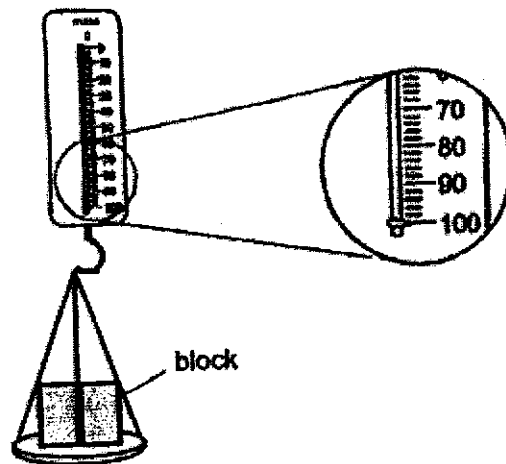

(ii) His teacher told him that the reading of the spring balance may not be accurate when the two blocks were placed on the pan.

Give a reason why this is so.

[1]

	2
--	---

(Go on to the next page)

- (b) Gerald wanted to make fruit juice using the juicer shown below. He realised that he had to cut fruit A into smaller pieces so that it could fit into the juicer.

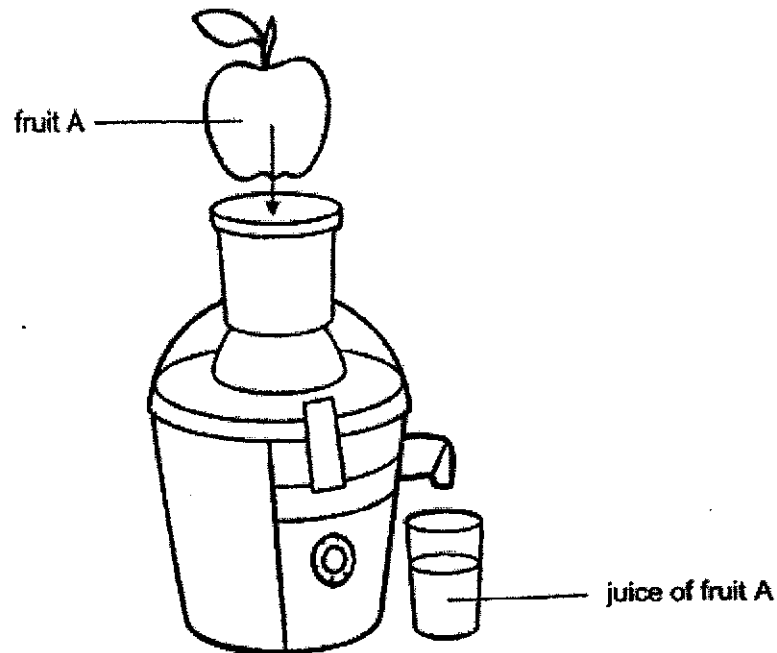

- (i) What property of matter does not allow fruit A to fit into the juicer? [1]

- (ii) Using the property of matter, state the difference between fruit A and its juice. [1]



(Go on to the next page)

- 38 John set up the following experiment in a dark room. The light sensor on the screen recorded a reading of 100 units.

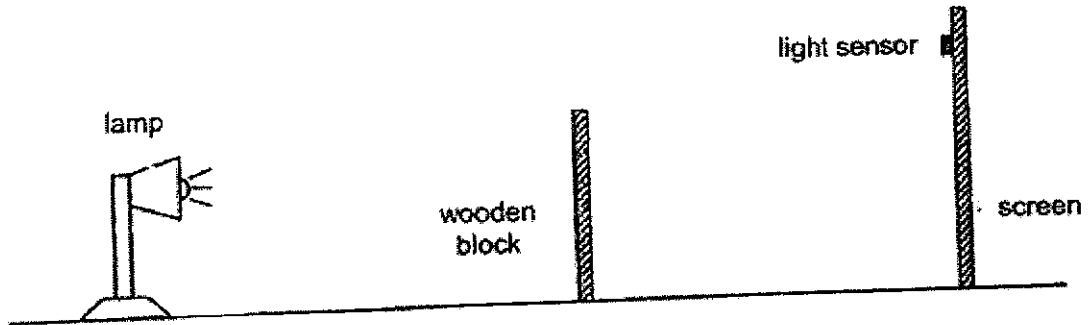

As John moved the screen in the set-up, the reading recorded by the light sensor started to decrease slowly to 60 units and then dropped to 0 units suddenly.

- (a) Did John move the screen closer or further away from the wooden block? [1]

- (b) State the difference in the reading recorded by the light sensor if the wooden block is replaced with a glass block. [1]

- (c) A shadow of the wooden block is cast. Explain how the shadow is formed. [1]

	3
--	---

(Go on to the next page)

- 39 Zoe conducted an experiment using metal coins X and Y. Both coins are of the same size but made of different materials.

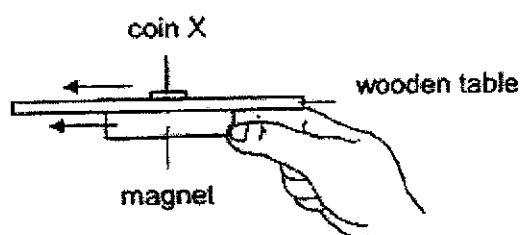

Figure 1

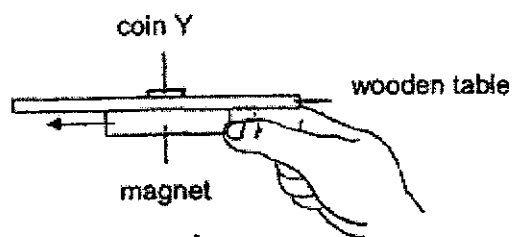

Figure 2

When Zoe dragged the magnet across the wooden table, coin X moved in the same direction as shown in Figure 1. When she dragged the magnet across the wooden table, coin Y did not move as shown in Figure 2.

- (a) Explain the observations made for coins X and Y using the physical properties of coins X and Y. [2]

- (b) If the wooden table is changed to a plastic table of the same thickness, will the same observation be made for coin X? Explain your answer. [1]

- (c) Name a metal that coin Y can be made of. [1]



(Go on to the next page)

- 40 On a sunny day, Huiji placed two plastic cones, J and K, on wet sand. Cones J and K were similar but J had a larger opening at the base than K. After several hours, she saw some water collected at the base of each cone as shown.

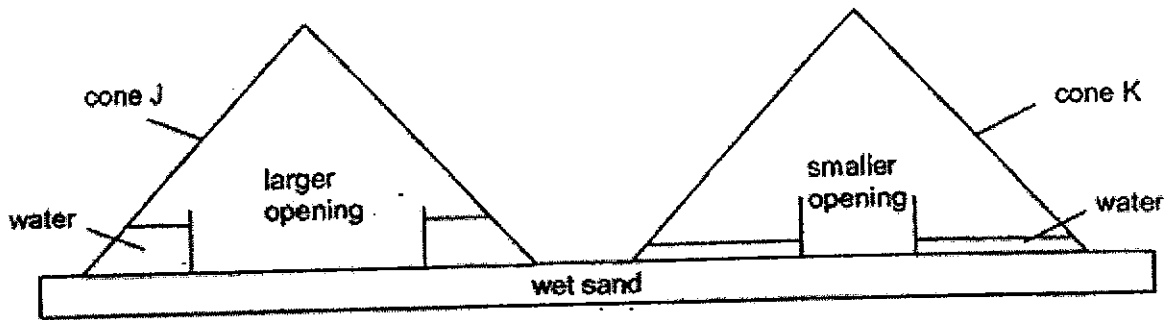

- (a) Explain how the water was collected.

[2]

- (b) Less water was collected in cone K than in cone J. Explain why.

[1]

	3
--	---

(Go on to the next page)

- 41 Ahmad installed a light bulb inside his wardrobe such that when he fully opens the sliding door of his wardrobe, the light bulb lights up.

He used two batteries, a light bulb, wires, steel tracks and a metal ball bearing to construct the circuit for the sliding door as shown below. The metal ball bearing is fixed to the sliding door and slides in between the plastic tracks and steel tracks when the door is moved.

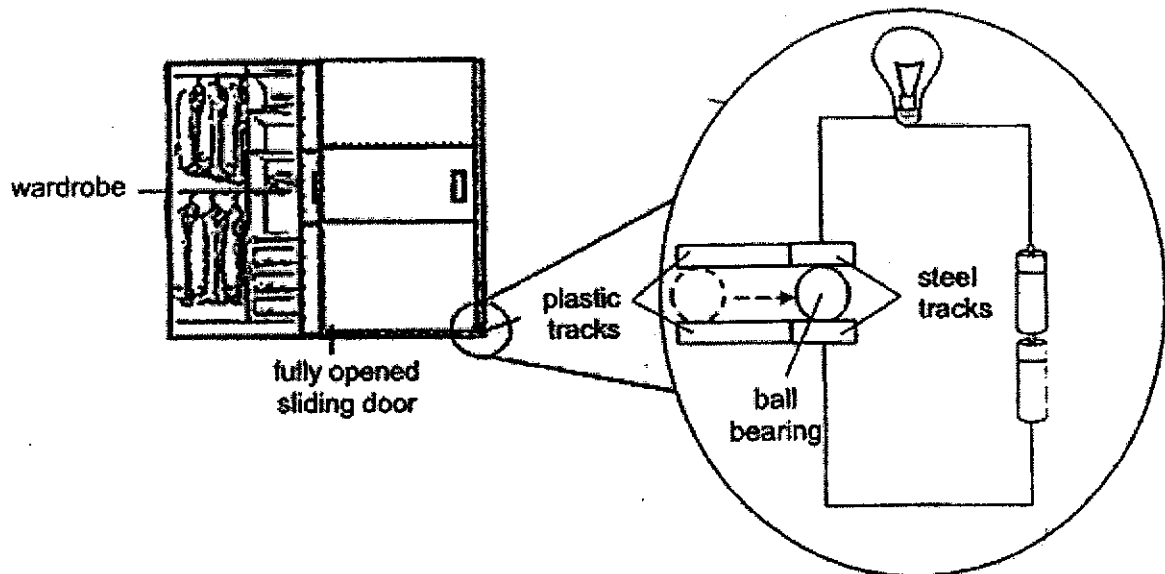

- (a) Explain why the bulb only lights up when the sliding door is fully opened. [2]

- (b) Will the bulb light up if the steel tracks were replaced with aluminium tracks? Explain why. [2]

END OF BOOKLET B

	4
--	---

SCHOOL : MARIS STELLA HIGH SCHOOL
 LEVEL : PRIMARY 5
 SUBJECT : SCIENCE
 TERM : 2021 SA2

SECTION A

Q 1	Q2	Q3	Q4	Q5	Q6	Q7	Q8	Q9	Q10
1	4	4	3	4	1	2	3	2	3
Q 11	Q12	Q13	Q14	Q15	Q16	Q17	Q18	Q19	Q20
4	4	4	3	2	1	2	1	2	1
Q 21	Q22	Q23	Q24	Q25	Q26	Q27	Q28		
2	1	3	2	3	4	3	4		

SECTION B

Q29)	<p>a)The seeds did not have enough oxygen to germinate.</p> <p>b)Yes. Seeds need warmth, oxygen and water to germinate and they still have what they require for germination in the cupboard.</p>
------	---

Q30)	 <p>The diagram shows three rectangular boxes arranged horizontally. The leftmost box is labeled 'Lungs', the middle box is labeled 'Heart', and the rightmost box is labeled 'All parts of the body'. Solid arrows point from 'Lungs' to 'Heart' and from 'Heart' to 'All parts of the body'. Dashed arrows point from 'Heart' back to 'Lungs' and from 'All parts of the body' back to 'Heart', representing the return of deoxygenated blood.</p> <p>a) b)(i)As one's lung capacity increases, the amount of oxygen their body can take in per breath increases. In the same amount of time, the person with a larger lung capacity needs to take fewer breaths to take in the same volume of oxygen compared to a person with a smaller lung capacity, thus the former has a lower breathing rate. (ii)Digestive system</p>
Q31)	<p>a)From 6am to 12pm, the average size of the tiny openings increases remains constant. b)Larger tiny openings allow the plant to take in more oxygen and carbon dioxide and release more oxygen during photosynthesis. c)The plant will lose more water in the form of water vapour.</p>
Q32)	<p>a)C B)Cell part A has a regular shape but not cell part C.</p>
Q33)	<p>a)By animal: B, By splitting: A b)The seeds can be dispersed independently. c)A,B D)(i)By spores (ii)Non-flowering plants</p>
Q34)	<p>a)Colour of light b)Red c)The red light allows the most photosynthesis to occur so the most amount of oxygen is released from the plant and the fish can take in the oxygen to survive.</p>
Q35)	<p>a)The strength of the material b)B is the strongest, followed by A and then C.</p>

Q36)	<p>a) Air in the bottle gains heat from the boiling water and expanded, causing the balloon to inflate.</p> <p>b) Smaller.</p> <p>c) The inner wall expanded faster than the outer wall.</p>
Q37)	<p>a(i) 88g</p> <p>(ii) The spring balance can only measure a maximum of 100g and the total mass of the 2 blocks is more than 100g.</p> <p>b(i) Solids have a definite shape.</p> <p>(ii) Fruit A has a definite shape while its juice has an indefinite shape.</p>
Q38)	<p>a) Further</p> <p>b) The reading will be more than 100 units.</p> <p>c) The shadow is formed when the light path is blocked by an object.</p>
Q39)	<p>a) Coin X is made from a magnetic material while Y is not.</p> <p>b) Yes. Magnetic strength can pass through non-magnetic materials and plastic is a non-magnetic material.</p> <p>c) Copper.</p>
Q40)	<p>a) Water in the wet sand gained heat from the surrounding air and evaporated, lost heat and condensed on the cooler inner surface of the cone to form water droplets, which dripped into the base of the cones.</p> <p>b) There was a smaller exposed surface area of the wet sand and the air in the cone, so the rate of evaporation was slower.</p>
Q41)	<p>a) The metal ball bearing will only be touching the steel tracks when the door is open, which forms a closed circuit.</p> <p>b) Yes. Aluminium is a conductor of electricity so a closed circuit can be formed.</p>

