



RAFFLES GIRLS' PRIMARY SCHOOL

END-OF-YEAR EXAMINATION  
2021

Section A	56
Section B	44
Your score out of 100	
Parent's signature	

Name : \_\_\_\_\_

Index No.: \_\_\_\_\_

Class: P5 \_\_\_\_\_

27 October 2021

SCIENCE

Duration: 1 h 45 min

SECTION A (28 x 2 marks)

For each question from 1 to 28, four options are given. One of them is the correct answer. Make your choice (1, 2, 3 or 4). Shade the correct oval (1, 2, 3 or 4) on the Optical Answer Sheet (OAS) provided.

1. Which one of the following is not a characteristic passed down from parent to offspring?
- (1) length of hair
  - (2) attached earlobes
  - (3) presence of dimples
  - (4) ability to roll the tongue

2. The diagrams below show a plant reproductive system and a female reproductive system.

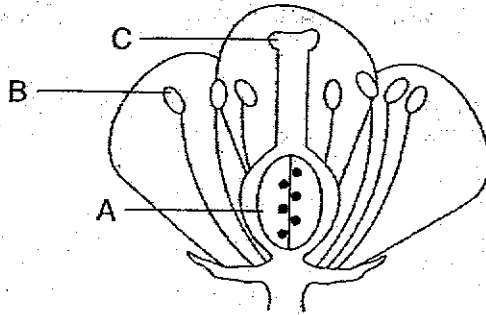

Plant reproductive system

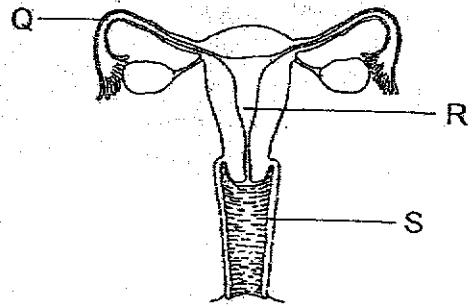

Human reproductive system

Where does the fertilised egg develop in both reproductive systems?

- (1) A and R
  - (2) B and S
  - (3) C and Q
  - (4) C and R
3. The diagram below shows the developmental stages, A, B and C, of a flowering plant. Fertilisation occurs between stages B and C.

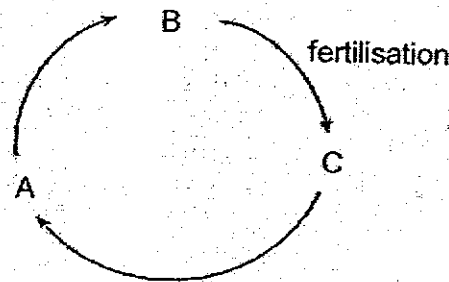

Which one of the following correctly identifies the stages?

	A	B	C
(1)	seed	young plant	adult plant
(2)	young plant	seed	adult plant
(3)	young plant	adult plant	seed
(4)	adult plant	seed	young plant

4. The diagram below shows the distribution of young plants of plants P, Q and R on an island over a period of time.

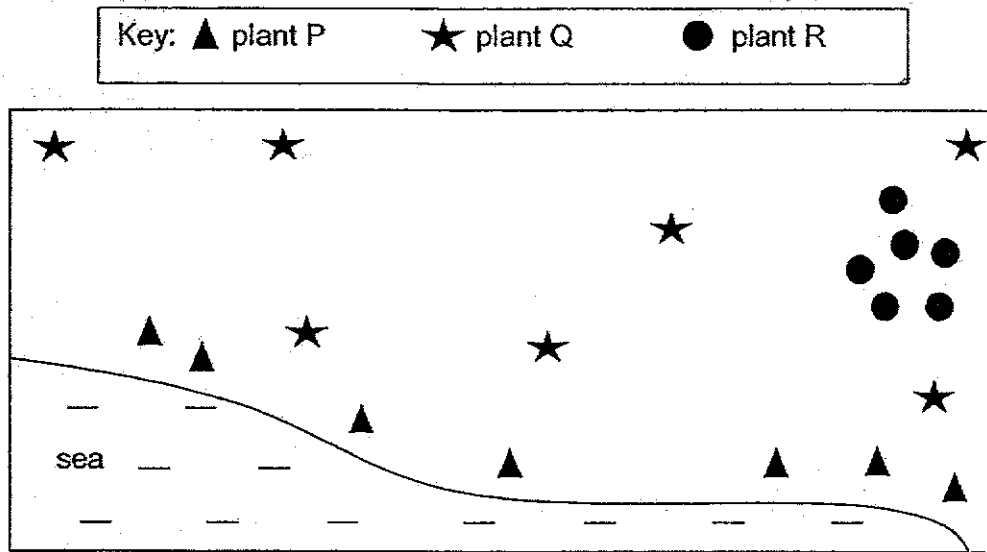

The diagrams below show the characteristics of fruits A, B, C and D.

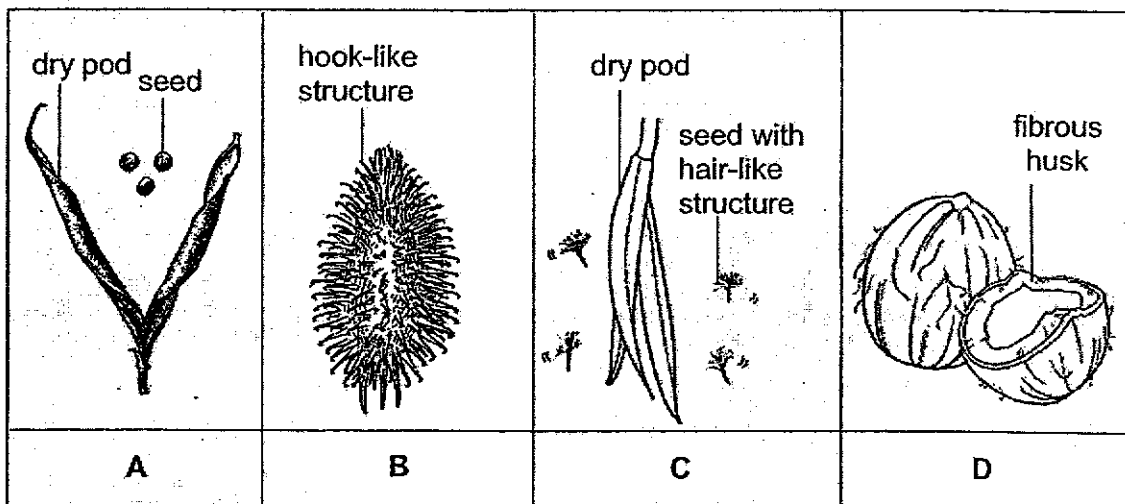

Which of the following fruits most likely belong to plants P, Q and R?

	plant P	plant Q	plant R
(1)	A	C	D
(2)	D	C	B
(3)	C	A	B
(4)	D	B	A

5. The diagram shows flowers on a plant.

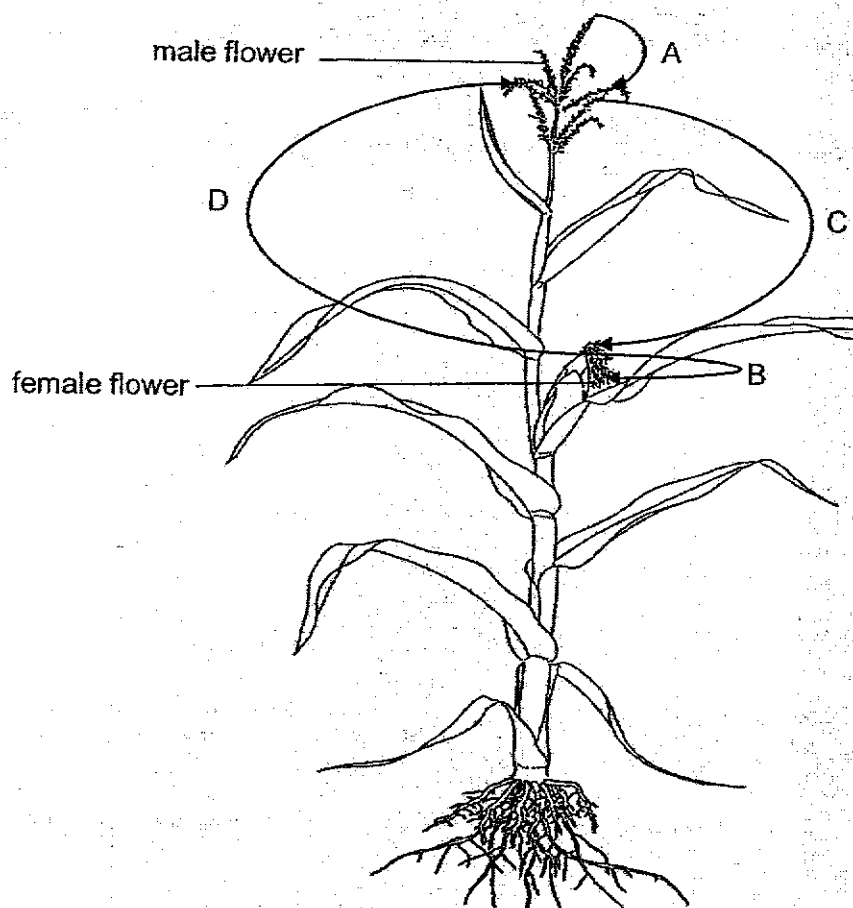

The flowers are dull in colour and unscented.

Which one of the following shows how the flowers are pollinated and the arrow that represents the pollination process correctly?

	pollinated by	pollination occurs at arrow
(1)	wind	A
(2)	insect	B
(3)	wind	C
(4)	insect	D

6. Sam wanted to find out if light is needed for the growth of mould on fruit X. He placed fruit X in four identical sealed boxes, P, Q, R and S, and exposed them to different conditions as shown in the table below. A tick (✓) shows the presence of the condition.

box	conditions		
	surrounding temperature (°C)	presence of water	presence of light
P	15	✓	
Q	35	✓	
R	15		✓
S	35	✓	✓

Which two set-ups should he use to carry out his experiment to carry out a fair test?

- (1) P and R  
 (2) Q and S  
 (3) R and S  
 (4) Q and R
7. Jane made the following observations on different plant parts, A, B, C and D, of a flowering plant.

part of a plant	function
A	helps plant in reproduction
B	absorbs water and dissolved mineral salts
C	allows for gaseous exchange to take place
D	contains two types of tube to transport substances

Based on the information above, which one of the following correctly identifies the parts of a plant?

	A	B	C	D
(1)	fruits	leaf	stem	roots
(2)	flowers	roots	leaf	stem
(3)	seed	stem	leaf	roots
(4)	stem	roots	seed	leaf

8. Ali wanted to find out how the colour of light, P, Q, R and S, affected the growth of a plant. He used four identical plants with a height of 10 cm, which had two leaves and a 5 cm root, exposed to the different coloured lights. He added the same amount of water to the plants daily.

After two weeks, he recorded the observations of the plants exposed to the different coloured lights in the table below.

colour of light	growth of plant		
	number of leaves	length of root (cm)	height of plant (cm)
P	2	5	10
Q	4	6	12
R	8	7	15
S	16	10	20

Based on the information above, which of the following conclusion(s) is/are correct?

- A Light P is not suitable for plant growth.
- B The plant exposed to light S had the maximum growth.
- C The shorter the length of the roots, the greater the volume of water the plant was able to absorb.

- (1) A only
- (2) C only
- (3) A and B only
- (4) B and C only

9. The classification chart below shows three human body systems.

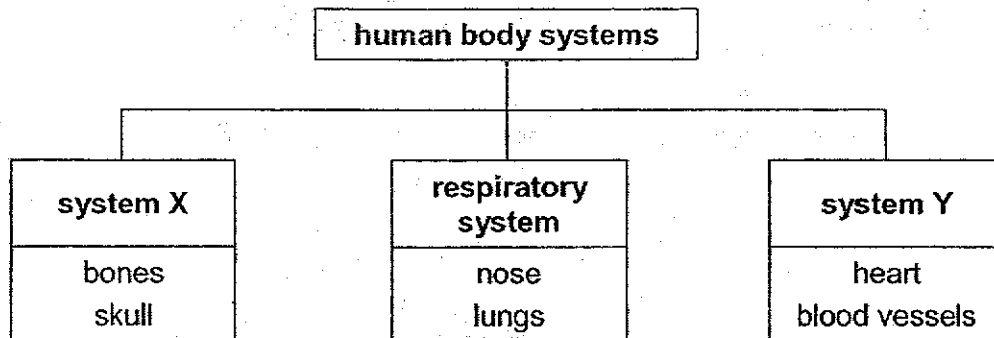

Which of the following shows the correct headings for systems X and Y?

	system X	system Y
(1)	muscular	circulatory
(2)	muscular	digestive
(3)	skeletal	circulatory
(4)	skeletal	muscular

10. Jonas wanted to conduct an experiment to find out if different amounts of digestive juice would affect the rate of digestion of food substance. He prepared the following set-ups for the experiment.

set-up	food substance	size of food substance (cm <sup>2</sup> )	volume of digestive juice (ml)
<b>A</b>	X	15	5
<b>B</b>	X	20	5
<b>C</b>	X	15	10
<b>D</b>	Y	20	10

Which two set-ups should Jonas use to ensure fair test?

- (1) A and B
- (2) A and C
- (3) B and C
- (4) B and D

11. Anna made a model representing the respiratory system as shown below.

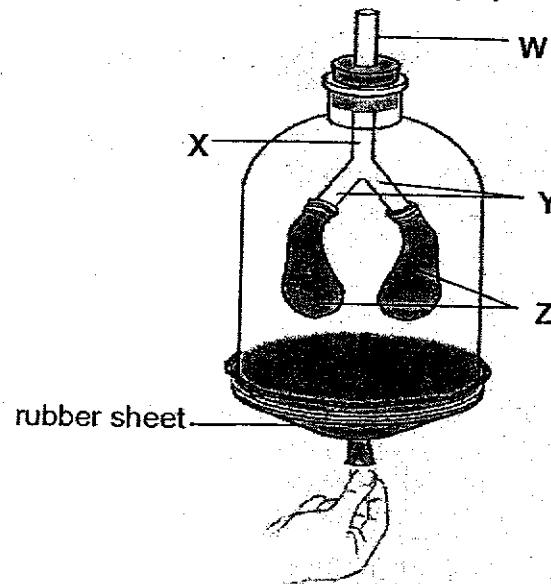

When she pulled the rubber sheet at the bottom or released the pulled rubber sheet, parts Z changed in size.

Which the following is/are correct?

- A When the rubber sheet was pulled, part Z would be inflated.
  - B When the rubber sheet was pulled, air would enter through W.
  - C When the pulled rubber sheet was released, part Z would be inflated.
  - D When the pulled rubber sheet was released, air would escape through W.
- (1) B only
  - (2) C only
  - (3) A, B and C only
  - (4) A, B and D only

12. Which of the following statement(s) about the human circulatory system and plant transport system is/are true?

- A Plants transport food from the roots to the leaves.
- B Humans have tubes to transport blood and materials around the body.
- C Only oxygen and digested food are transported around the body of a human.
- D The stem of a plant performs the same function as the heart in transporting materials around the plant.

- (1) A only
- (2) B only
- (3) A, B and C only
- (4) A, C and D only



13. The diagram below shows how an insect obtains its food by inserting its mouth part into the stem.

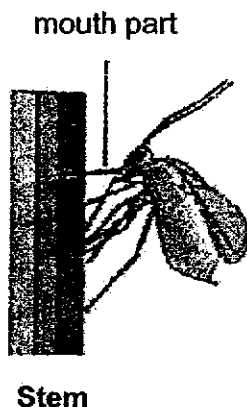

The diagram below shows the cross-section of the stem of a plant.

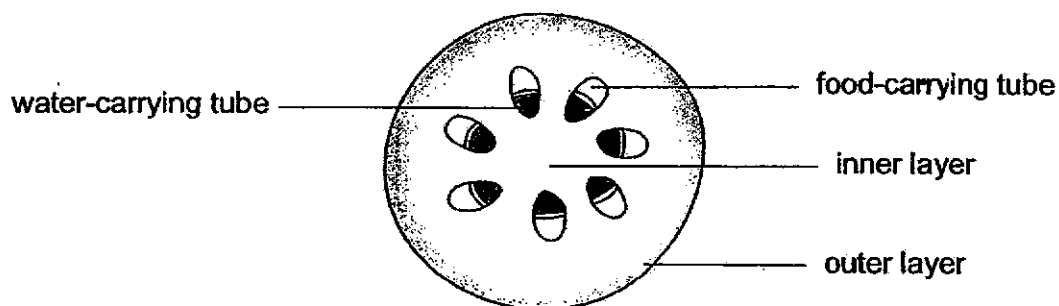

**Cross-section of a stem**

Which part of the stem should the insect insert its mouth part to obtain its food?

- (1) outer layer
- (2) inner layer
- (3) food-carrying tube
- (4) water-carrying tube

14. The diagram below represents how substances A and B are transported in a plant. X is a part of a plant. P and Q are tubes.

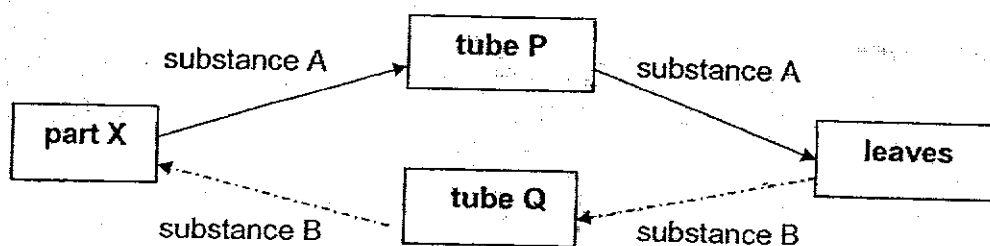

Which one of the following correctly identifies part X and substances A and B?

	part X	substance A	substance B
(1)	leaf	water	mineral salts
(2)	stem	mineral salts	food
(3)	roots	food	mineral salts
(4)	roots	water	food

15. An ice cube was taken out of the freezer and placed on a plate as shown in the diagram below. After three minutes, the ice cube started to melt.

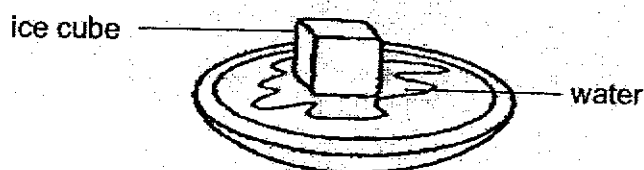

Which one of the following statements about the melting ice cube is true?

- (1) The water was gaining heat from the ice cube.
- (2) The ice cube was losing heat to the surrounding air.
- (3) The temperature of the melting ice cube was increasing.
- (4) The temperature of the melting ice cube remained constant.

16. The diagram below shows the water cycle.

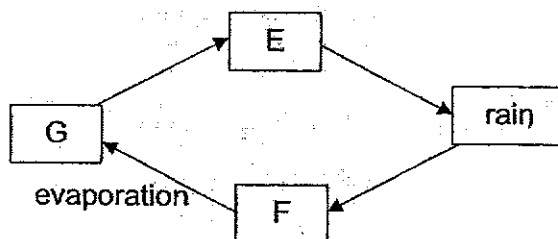

Which of the following, E, F and/or G, of the water cycle does water exist in the gaseous state?

- (1) E only
  - (2) F only
  - (3) G only
  - (4) E and G only
17. A beaker containing tap water and ice was placed in an air-tight container as shown in the diagram below. It was left on a table for thirty minutes.

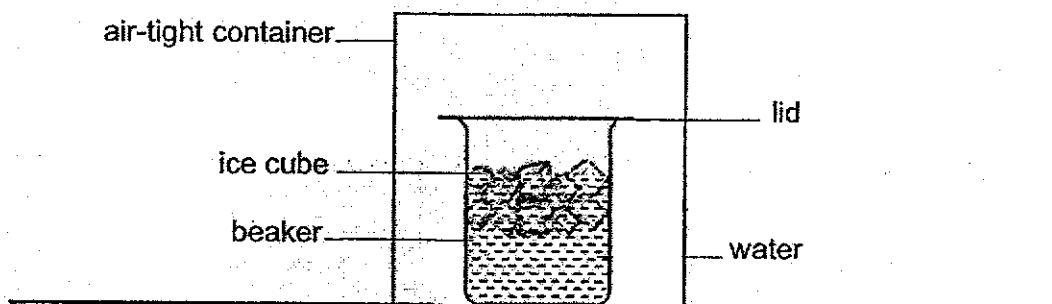

Which of the following statement(s) is/are true after thirty minutes?

- A There would be water droplets on the under-side of the lid.
- B There would be water droplets on the outer surface of the beaker.
- C The amount of water vapour in the air-tight container would increase.

- (1) A only
- (2) B only
- (3) A and B only
- (4) A and C only

18. Janice placed two identical plastic bottles of water into different containers filled with the same amount of ice cubes as shown below. She left the bottles in the containers for fifteen minutes.

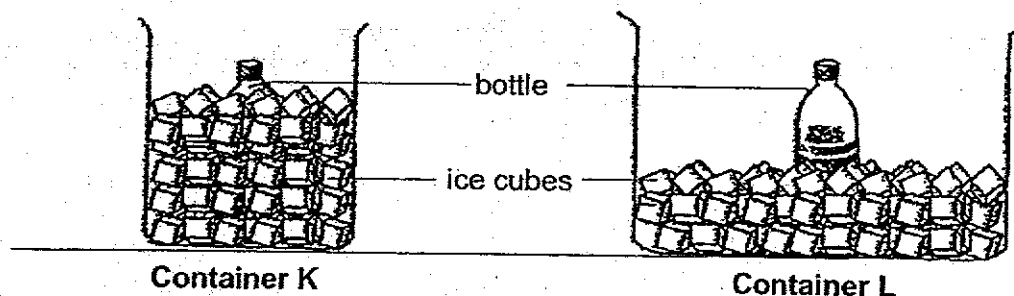

After fifteen minutes, the temperature of the water in the bottles were measured and recorded in the table below.

Container	Temperature of water in the bottle (°C)	
	At first	After fifteen minutes
K	30	17
L	30	25

Which one of the following statements explains the reason for the difference in temperature of water after fifteen minutes?

- (1) The ice cubes in container K melted faster than the ice cubes in container L.
  - (2) Heat from the ice cubes in container K travelled faster to the water in the bottle.
  - (3) The bottle of water in container K had more contact surface area with the ice cubes.
  - (4) There was less heat in the bottle of water in container L than bottle of water in container K.
19. Which of the following are sources of light?
- A sun
  - B fire
  - C mirror
  - D lightning
- (1) A and B only
  - (2) A and C only
  - (3) A and D only
  - (4) A, B and D only

20. Which one of the following diagrams shows the correct path of light that enables the girl to see the bench?

(1)

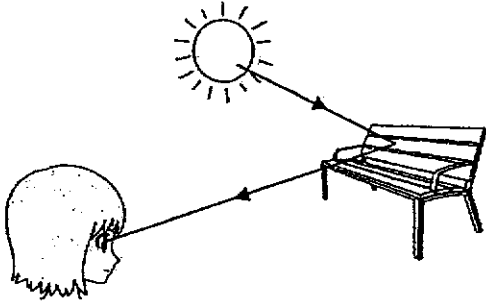

(2)

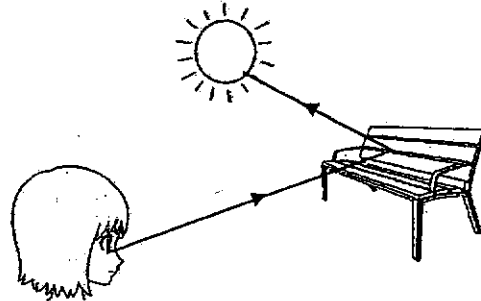

(3)

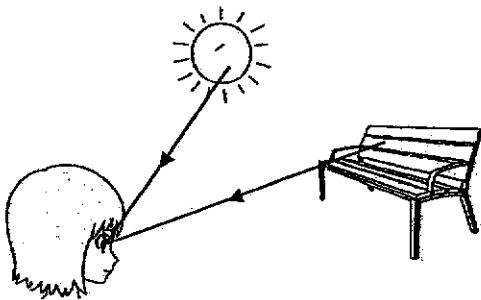

(4)

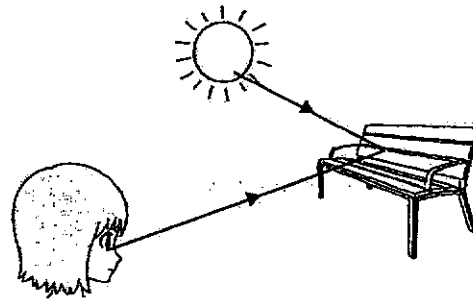

21. Joe prepared a set-up using materials E, F and G, of identical thickness and height.

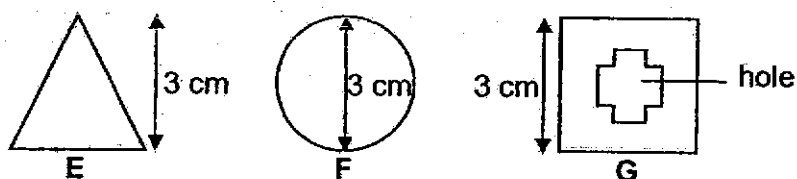

He placed the setup in a dark room as shown below.

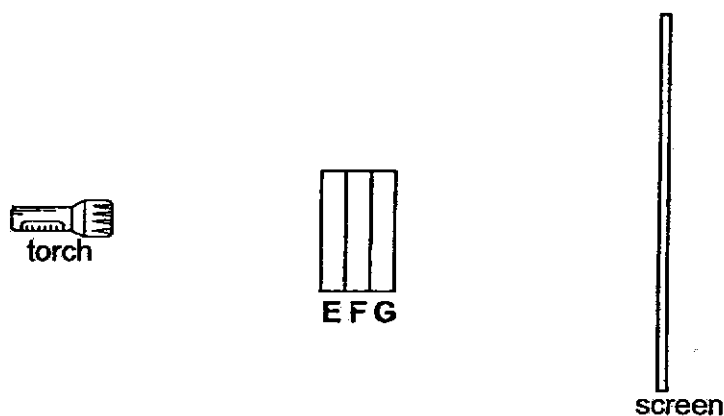

Joe observed the shadow cast on the screen.

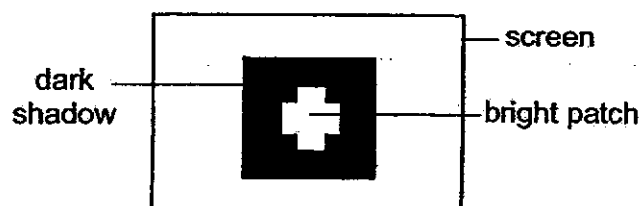

Which one of the following best represents the properties of the materials E, F and G?

	E	F	G
(1)	allows most light to pass through	allows most light to pass through	does not allow light to pass through
(2)	allows most light to pass through	does not allow light to pass through	does not allow light to pass through
(3)	does not allow light to pass through	allows most light to pass through	allows some light to pass through
(4)	does not allow light to pass through	allows most light to pass through	does not allow light to pass through

22. The diagram below shows an experimental set-up used to measure the amount of light reflected by materials P, Q, R and S.

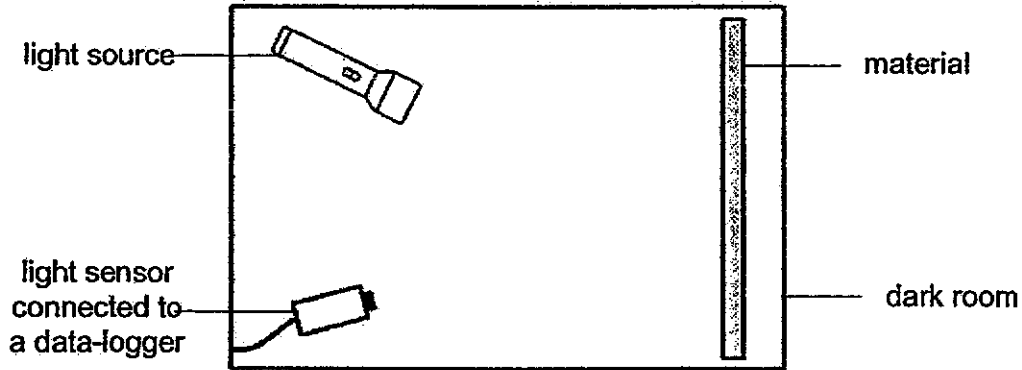

The amount of light reflected by materials P, Q, R and S was recorded in the table below.

materials	amount of light reflected (units)
P	2340
Q	480
R	1200
S	50

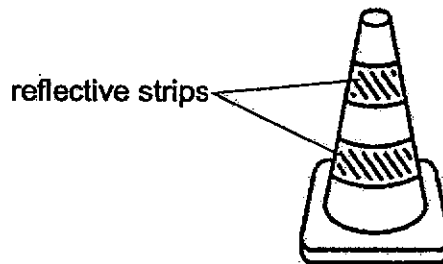

**Traffic cone**

Based on the information above, which material, P, Q, R or S, is most suitable to make the reflective strips on the traffic cone?

- (1) P
- (2) Q
- (3) R
- (4) S

23. The diagram shows four identical beakers filled with different volume of water at different temperatures.

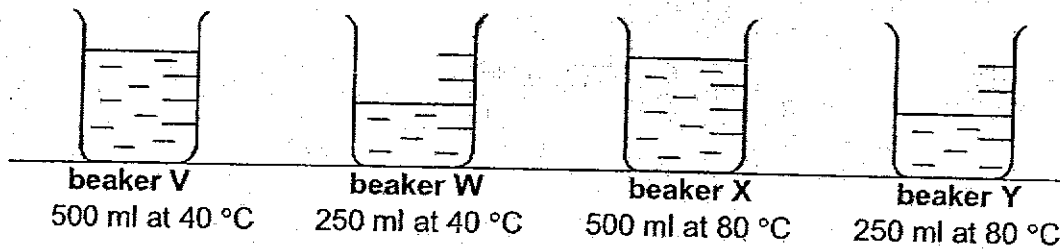

Which beaker of water contained the most amount of heat?

- (1) beaker V
  - (2) beaker W
  - (3) beaker X
  - (4) beaker Y
24. A glass of hot coffee was placed in a basin of cold water in a room with a constant temperature of 30 °C.

Which one of the following graphs shows the temperature of the coffee and the water over a period of four hours?

(1) temperature (°C)

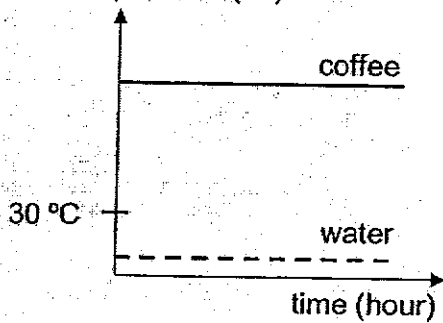

(2) temperature (°C)

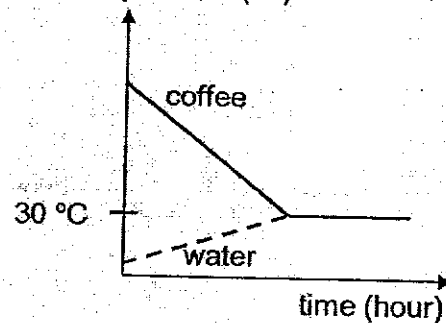

(3) temperature (°C)

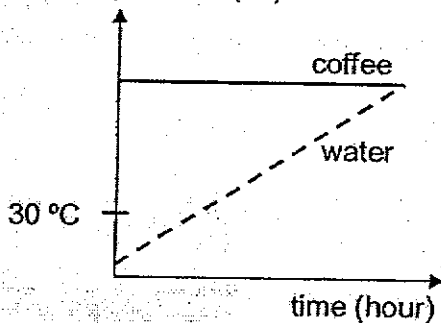

(4) temperature (°C)

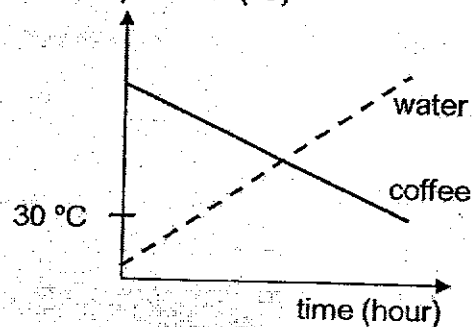



25. When Randy touched a metal door knob, his hand felt cold.

Which of the following explains the observation?

- (1) Randy's hand lost heat to the door knob.
- (2) Randy's hand lost heat to the surrounding air.
- (3) The metal door knob lost heat to Randy's hand.
- (4) The surrounding air lost heat to the metal door knob.

26. The diagram below shows an electric circuit.

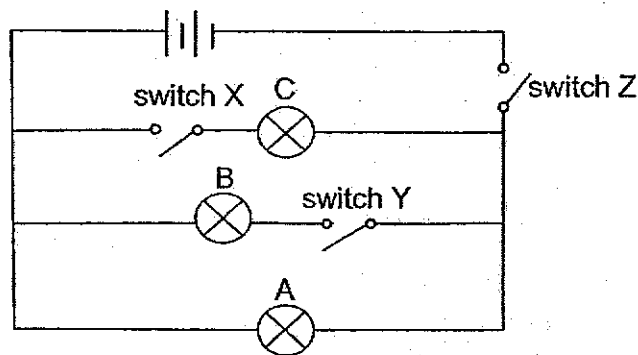

Which of the following shows the correct sequence in which the switches were closed such that bulb A will light up first, followed by bulb B and then bulb C?

sequence to close the switch...			
	first	second	third
(1)	Z	X	Y
(2)	X	Y	Z
(3)	Y	Z	X
(4)	Z	Y	X

27. Ethan set up the circuit below.

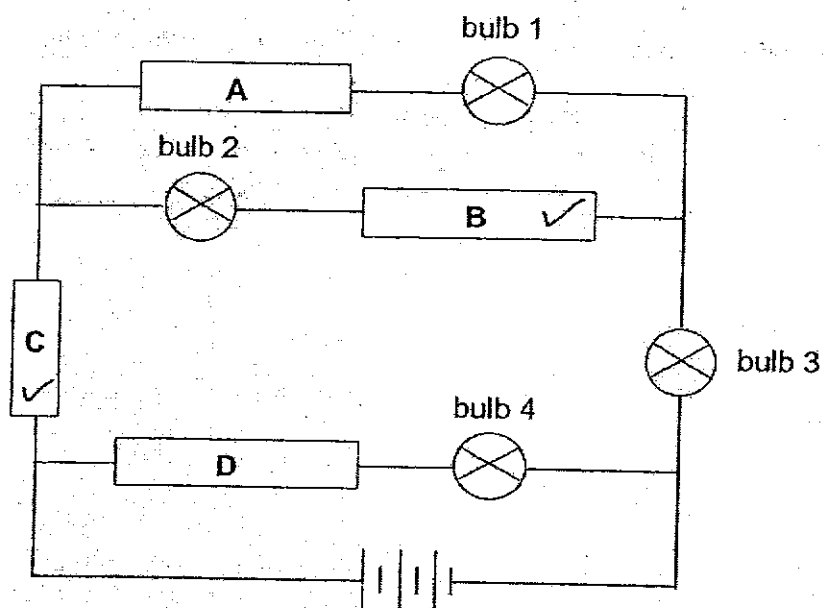

Ethan has four rods made of aluminum, copper, wood and glass respectively.

Which one of the following correctly represents the rods such that only bulbs 2 and 3 will light up?

	aluminum rod	copper rod	wood rod	glass rod
(1)	B	A	D	C
(2)	C	A	B	D
(3)	C	B	A	D
(4)	D	B	C	A

28. Lee Lee set up an electrical circuit as shown below.

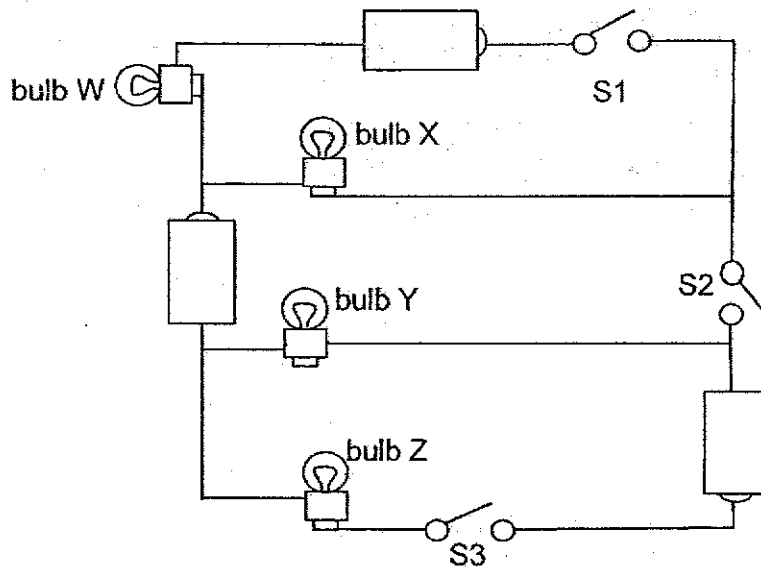

Given that all the bulbs are working, what is the least number of bulbs that can light up when any two of the switches, S1, S2 and S3, are closed?

- (1) one
- (2) two
- (3) three
- (4) four



Name: \_\_\_\_\_ Index No: \_\_\_\_\_ Class: P5 \_\_\_\_\_

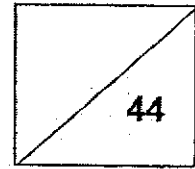

**SECTION B (44 marks)**

For questions 29 to 41, write your answers clearly in the spaces provided.  
The number of marks is shown in brackets [ ] at the end of each question or part question.

29. The diagrams below show the human and plant reproductive systems.

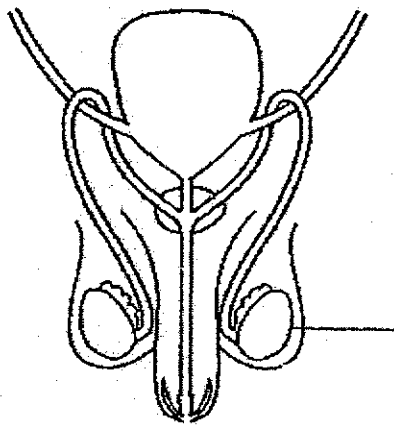

**Human reproductive system**

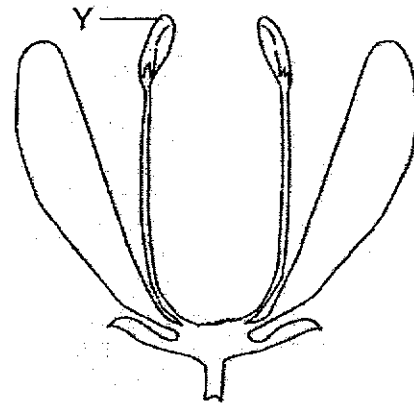

**Plant reproductive system**

- (a) In the diagram above, mark an X on the human reproductive system that has the similar function as part Y of the plant reproductive system. [1]
- (b) Name and state the function of the organ in (a). [1]

*Continue on the next page*

Score	2
-------	---

Continued from previous page

The diagrams below show the reproductive system of two females whose ovary/ovaries were removed.

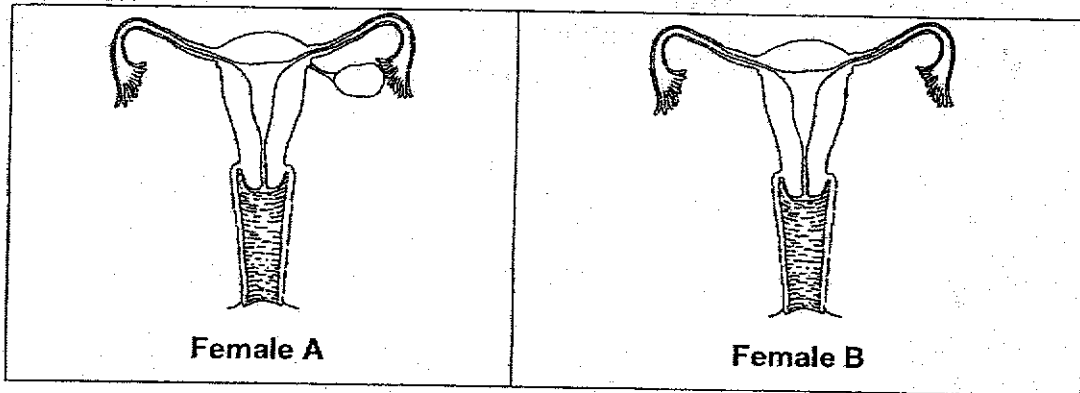

- (c) Which one of the above females, A or B, would still be able to reproduce naturally?  
Give a reason for your answer.

[1]

---

---

Score	1
-------	---

30. The diagram below shows a flower.

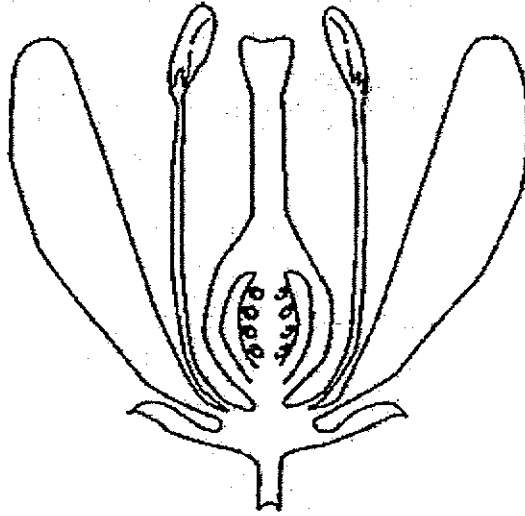

- (a) In the diagram above, label and name the part of the flower that will develop into a fruit. [1]
- (b) Name the part of the flower that will develop into a seed. [1]

Peter wanted to find out the conditions that seeds need to germinate. He prepared four set-ups, A, B, C and D, using identical seeds and exposed them to the conditions shown below.

set-up	number of seeds	amount of water (ml)	temperature (°C)	oxygen	light
A	5	0	30	present	present
B	5	20	30	absent	present
C	5	20	100	present	absent
D	5	20	30	present	absent

- (c) In which set-up(s), A, B, C or D, would the seeds germinate after a week? Explain your answer. [1]

Continue on the next page

Score	3
-------	---

Continued from previous page

The diagram below shows the stages of growth of a bean plant.

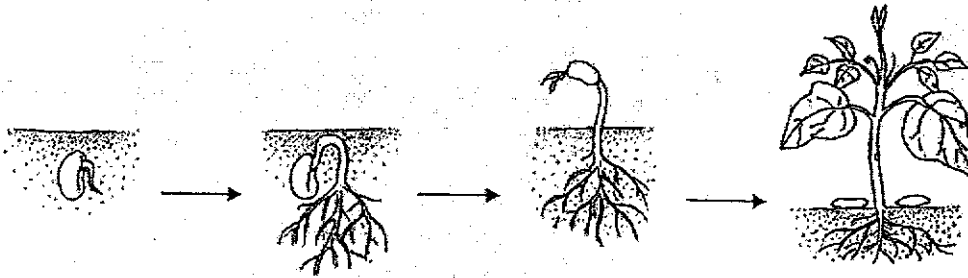

- (d) Draw a line in the graph below to show the relationship between the mass of the seed leaves and the height of the seedling during germination. [1]

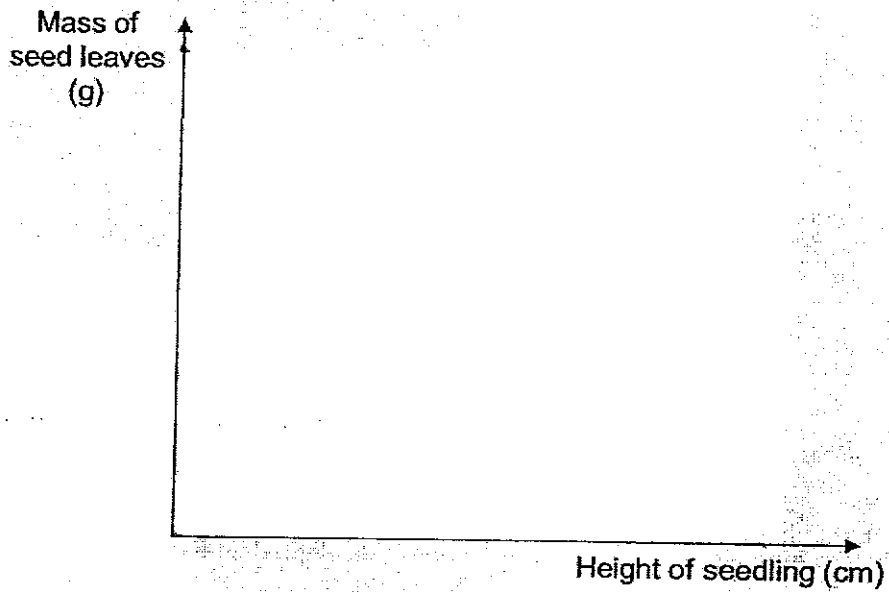

Score	1
-------	---

P5 Science EYE 2021



31. Chloe carried out an experiment as shown below. Beakers A, B and C were left near the window for a week.

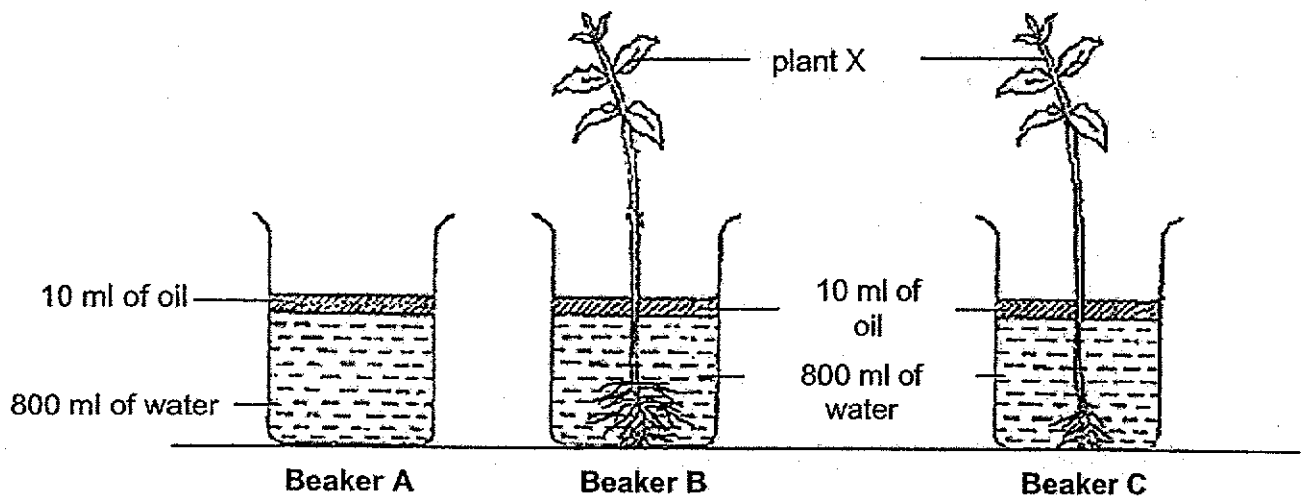

Chloe recorded the volume of water in each beaker on day 1 and day 7 in the table below.

beaker	volume of water (ml)	
	day 1	day 7
A	800	800
B	800	550
C	800	650

- (a) Compare the change in the volume of water between beakers B and C over the seven days and explain the difference in the results. [2]

---



---



---

- (b) Explain the purpose of beaker A. [1]

---



---

Score	3
-------	---

P5 Science EYE 2021

32. The diagram below shows the percentage of undigested food substance A in different organs in the human digestive system after a meal.

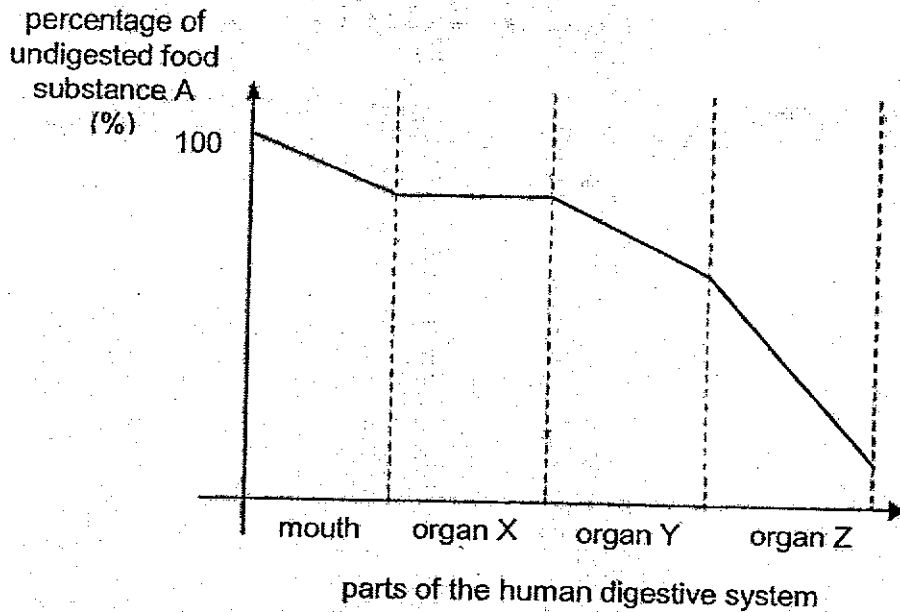

(a) Identify organs X and Z. [1]

organ X: \_\_\_\_\_

organ Z: \_\_\_\_\_

(b) Name the part(s) of the digestive system that produce(s) digestive juices. [1]

\_\_\_\_\_

(c) Explain clearly why the percentage of undigested food substance A decreased the greatest in organ Z. [1]

\_\_\_\_\_

\_\_\_\_\_

Score	3
-------	---

33. The diagram below shows how digested food and gases are transported in the human body.

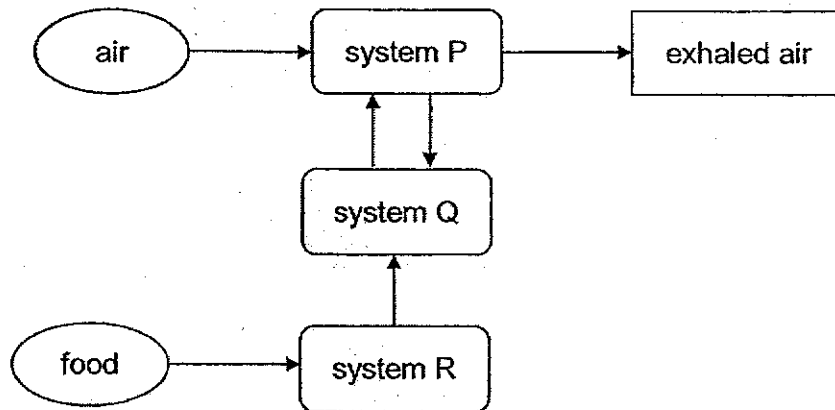

(a) Identify system P.

[1]

---

(b) Name two gases which will increase in quantity in the exhaled air as compared to the inhaled air.

[1]

(i) \_\_\_\_\_

(ii) \_\_\_\_\_

(c) Explain how systems Q and R work together to ensure that cells in the other parts of the body receive water.

[1]

---



---

Score	3
-------	---

34. The diagram below shows the human respiratory system and part of a leaf.

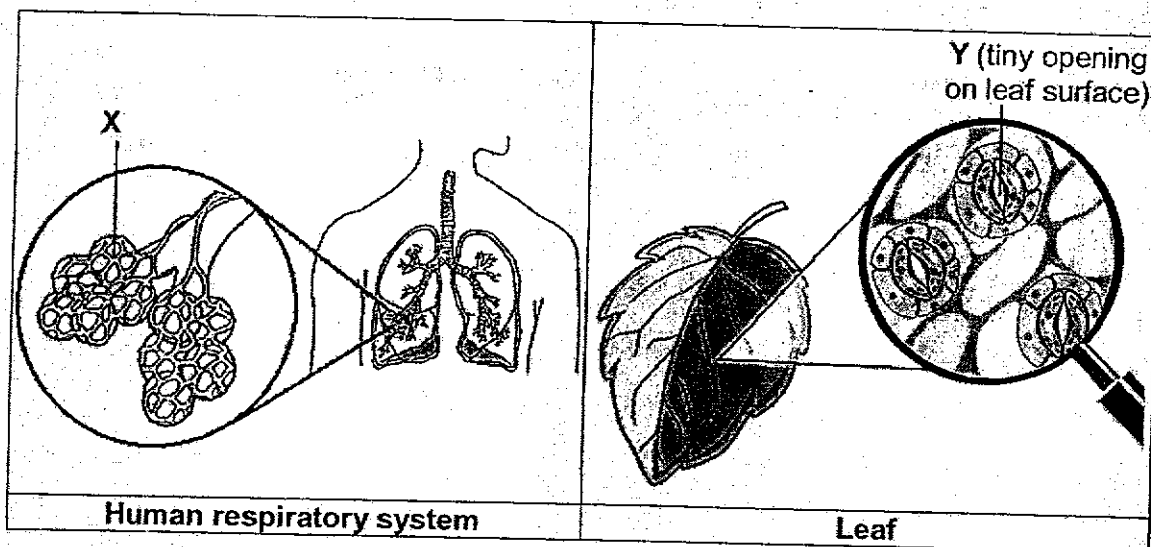

- (a) State one common function between structure X and structure Y. [1]

---



---

- (b) The surfaces of the leaves of a plant were coated with a layer of oil. One week later, the plant died.

Explain why the plant died. [2]

---



---

Score	3
-------	---

35. The diagram below shows a plant.

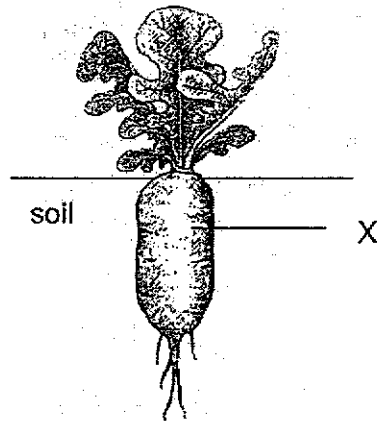

(a) Which part of the plant does X represent? [1]

---

(b) What is transported to part X to be stored? [1]

---

The diagram below shows another plant.

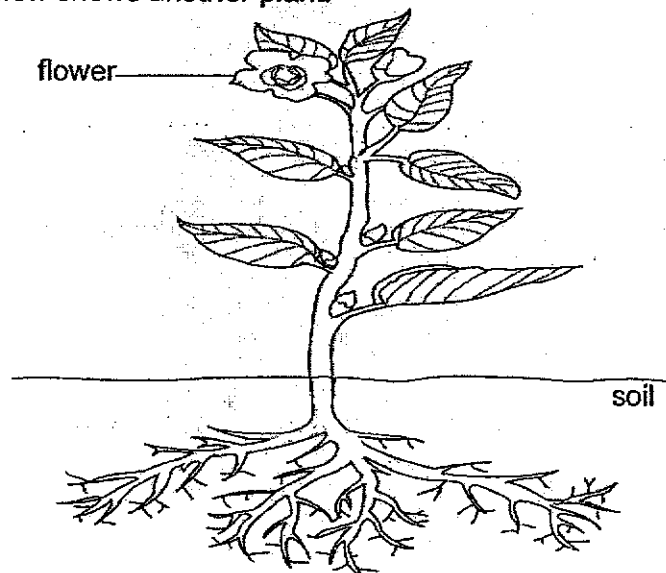

(c) Draw arrows in the diagram above to show how water is transported to the flower on the plant. [1]

Score	3
-------	---

36. Peter carried out an experiment by cutting and removing two rings, X and Y, of different thickness from the stem of a plant as shown below.

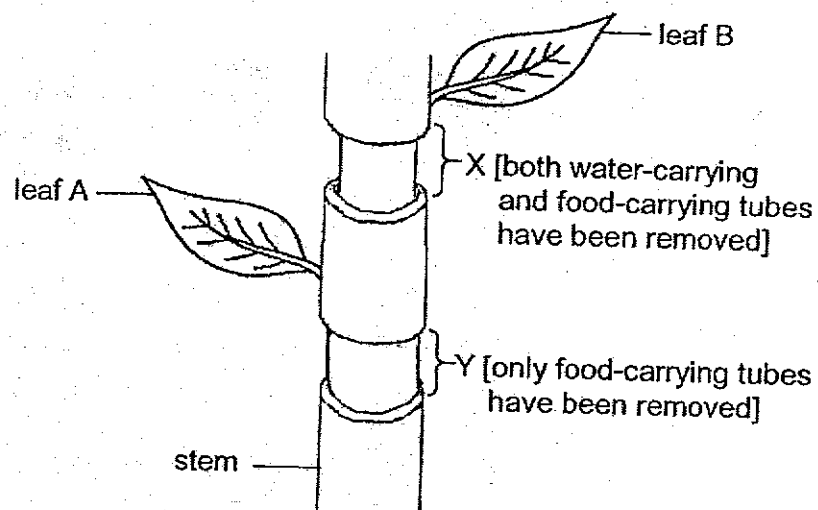

The stem shown above was then placed in a beaker of red-coloured water. He observed the colour of leaves A and B and recorded his observation in the table below.

- (a) Based on the information above, put a tick (✓) in the correct boxes indicating the colour of leaves A and B after one day. [1]

Leaf	Green	Red
A		
B		

Continue on the next page

Score	1
-------	---

Continued from previous page

After a week, the stem at W swelled as shown in the diagram below.

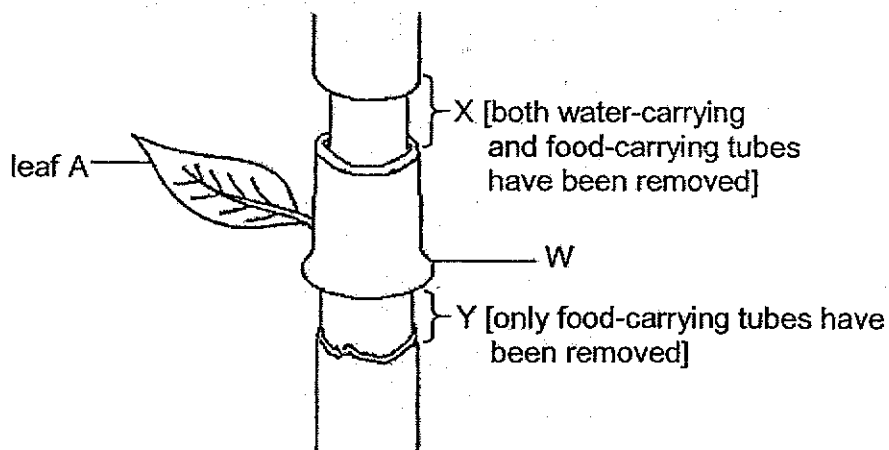

(b) Explain why part W of the stem swelled up after a week.

[2]

---



---

Score	2
-------	---

P5 Science EYE 2021

37. Rani's living room and kitchen are separated by a glass door as shown in the diagram below. Rani was in the living room with the air conditioner turned on at  $18\text{ }^{\circ}\text{C}$  while her mother was in the enclosed kitchen cooking a meal. The temperature in the kitchen was  $36\text{ }^{\circ}\text{C}$  and the glass door was completely closed.

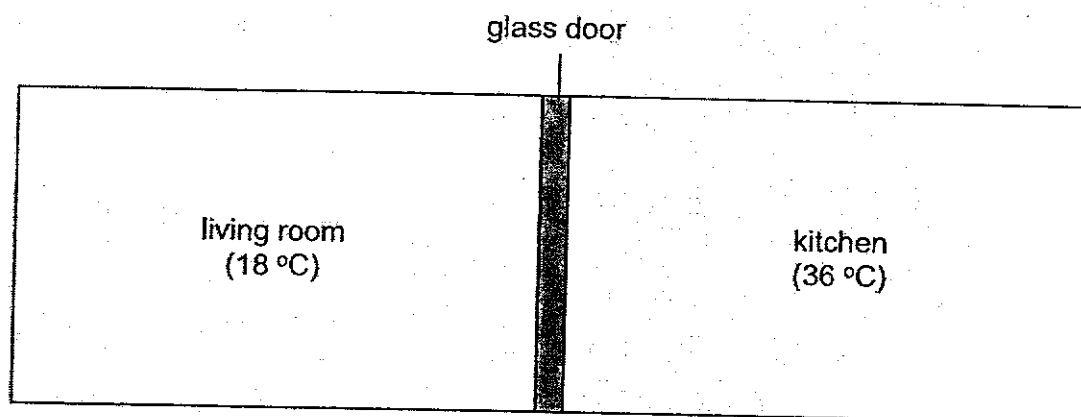

- (a) After thirty minutes, Rani saw that there were water droplets on the glass door.
- (i) In the diagram above, draw the water droplets on the correct part of glass door. [1]
- (ii) Explain your answer in (i). [2]

---



---



---

Then, Rani's mother stopped cooking. After an hour, the temperature in the kitchen was  $25\text{ }^{\circ}\text{C}$ .

- (b) It was observed that there were less water droplets formed on the glass door. Explain the observation. [1]

---



---

Continue on next page

Score	4
-------	---

P5 Science EYE 2021



Continued from previous page

Rani's mother washed the dishes and placed them as shown in the diagram below.



Plates on a stack

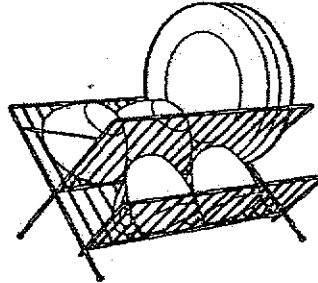

Plates on a rack

(c) Which plates, placed on a stack or on a rack, would dry faster? Explain your answer.

[1]

---

---

Score	1
-------	---

38. Ben was performing on a stage where three stage lights, X, Y and Z, were positioned as shown in the diagram below.

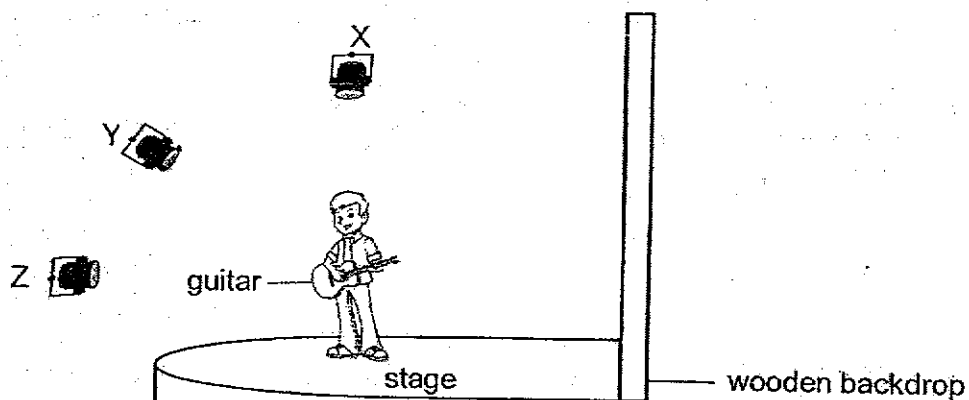

- (a) If all three stage lights were turned on at the same time, how many shadow(s) of Ben would be observed? [1]
- 
- (b) Which stage light, X, Y or Z, would allow the shortest shadow of Ben to be cast on the wooden backdrop? [1]
- 

Towards the end of the performance, only stage light Z was turned on. The diagram below shows the shadow cast on the wooden backdrop.



- (c) Based on the diagram above, state the property of the material of Ben's guitar. [1]
- 
- (d) Describe what would happen to the size of Ben's shadow as he moved nearer to the wooden backdrop of the stage. [1]
- 

Score	4
-------	---

P5 Science EYE 2021

39. A balloon was set up near a sharp pointed metal rod as shown in the diagram below.

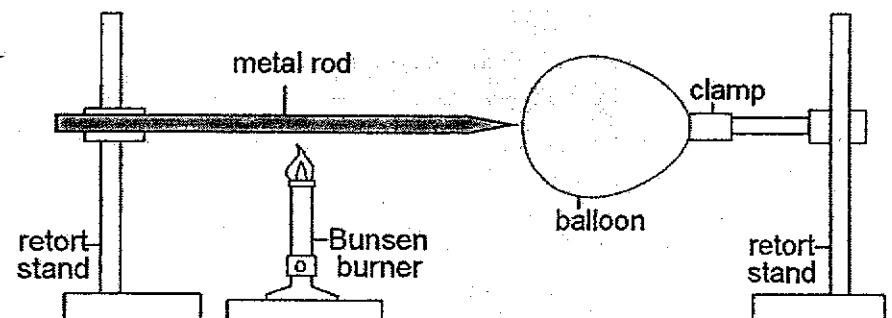

The metal rod was heated using a Bunsen burner.

After three minutes, the balloon burst.

- (a) Explain why the balloon burst. [1]

---



---

The sharp pointed metal rod was then replaced with a sharp pointed glass rod of identical length, size and shape, placed at the same distance from the balloon.

The glass rod was heated using the same Bunsen burner. The balloon did not burst after three minutes.

- (b) Give a reason for the observation above. [1]

---



---

Continue on next page

Score	2
-------	---

Continued from previous page

In another experiment, a rod made of metal and glass was placed over a Bunsen burner as shown in the diagram.

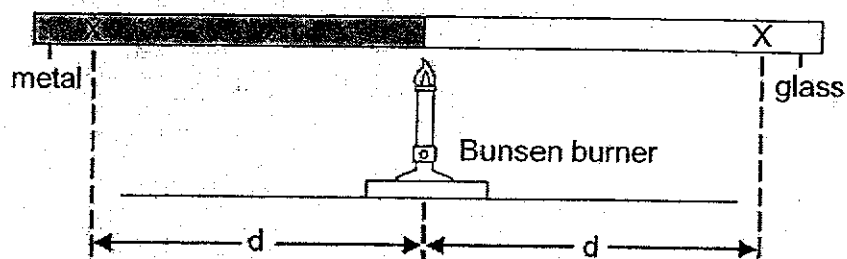

The temperatures of the metal and glass parts of the rod were measured at a distance,  $d$ , away from the middle of the rod. Lines P and Q show how the temperatures of the two rods changed with time.

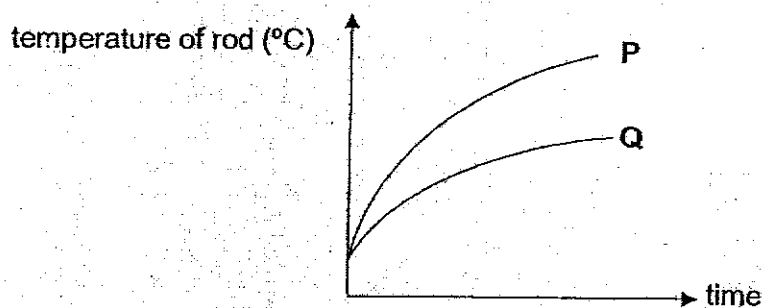

- (c) Which line, P or Q, best represents the change of temperature of the metal part of the rod? Give a reason for your answer. [2]

---



---

Score	2
-------	---

40. Kenny set up two electrical circuits, J and K, with light bulbs in different arrangements. He added an identical light bulb to each circuit after recording the light intensity. He plotted the results as shown in the graph below.

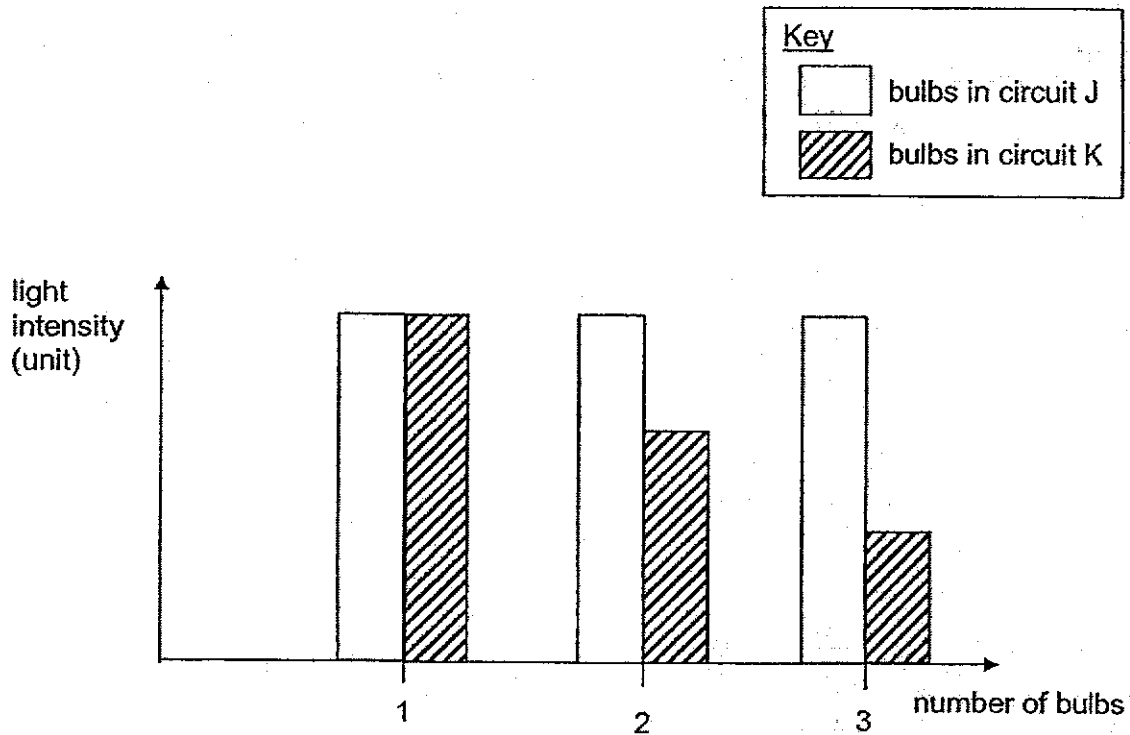

- (a) Circle the correct answer to show the arrangement of bulbs in each circuit. [1]

(i) Circuit J: parallel / series

(ii) Circuit K: parallel / series

Continue on the next page

Score	1
-------	---

P5 Science EYE 2021

Continued from previous page

Kenny then constructed an electrical circuit using a battery and three identical light bulbs, A, B and C, as shown below.

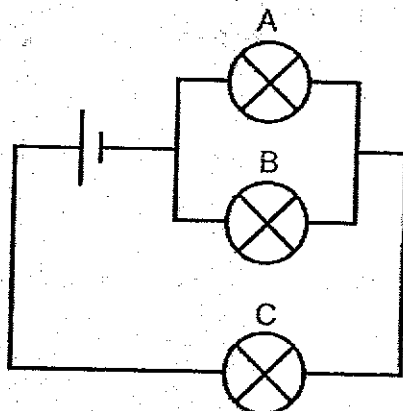

- (b) Kenny observed that when one of the bulbs was fused, the other bulbs remained lit.

Identify the bulb that was fused.

[1]

Score	1
-------	---

41. The diagram below shows the parts of a torch.

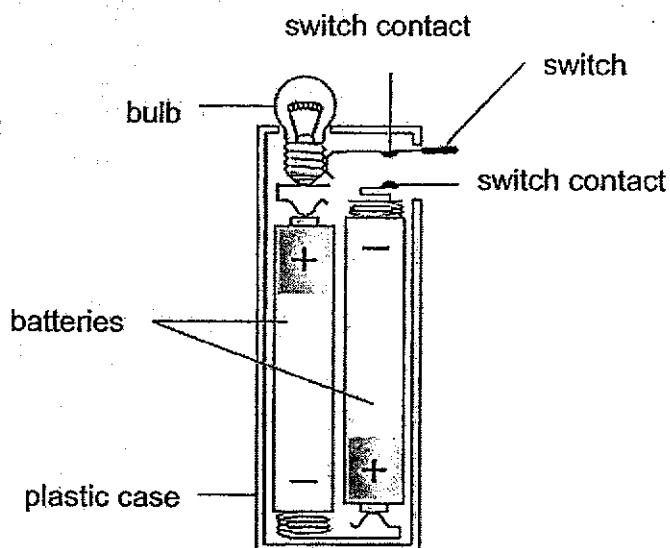

- (a) In the space provided below, draw a circuit diagram using electrical symbols to show how the bulb, the batteries and the switch are connected in the torch when the switch is opened. [2]

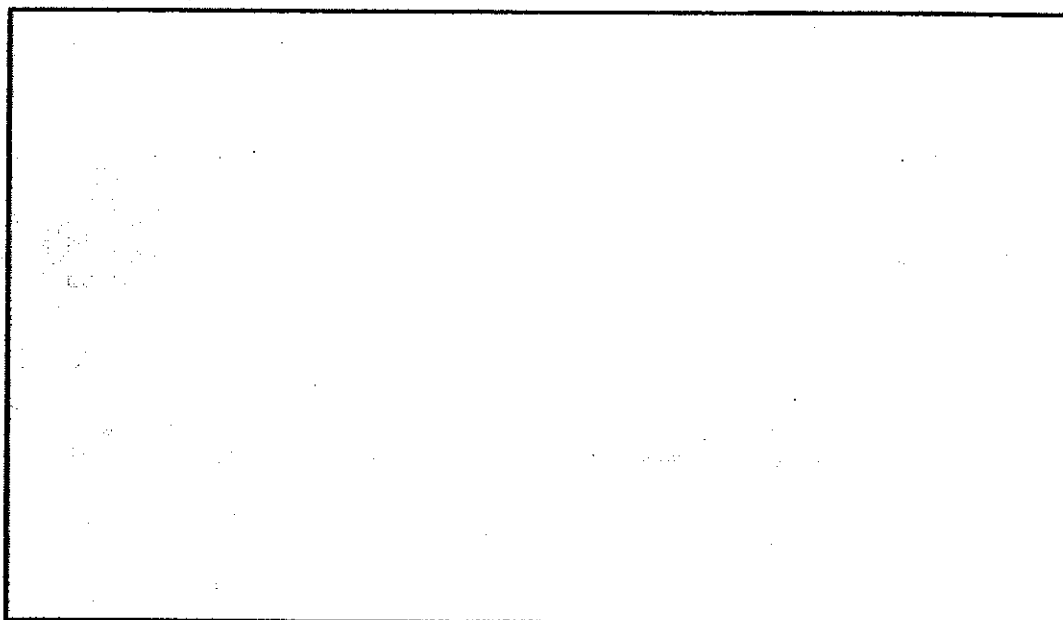

Continue on the next page

Score	2
-------	---

Continued from previous page

Edwin bought a new torch that came with two new batteries. He noticed that there was a paper strip between the contacts of the switch as shown below. All the components of the torch are working.

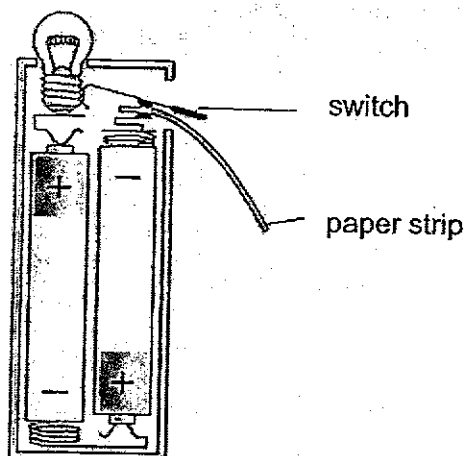

- (b) Explain why when the paper strip was placed between the contacts of the switch, the bulb did not light up when the switch was turned on. [1]

Edwin re-arranged the batteries in his torch as shown below.

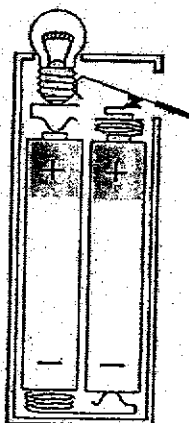

- (c) Would the bulb light up? Explain your answer. [1]

END OF PAPER

Score	2
-------	---

P5 Science EYE 2021



SCHOOL : RAFFLES GIRLS' PRIMARY SCHOOL  
 LEVEL : PRIMARY 5  
 SUBJECT : SCIENCE  
 TERM : 2021 END OF YEAR EXAMINATION

**SECTION A**

Q 1	Q2	Q3	Q4	Q5	Q6	Q7	Q8	Q9	Q10
1	1	3	4	3	2	2	3	3	2
Q 11	Q12	Q13	Q14	Q15	Q16	Q17	Q18	Q19	Q20
4	2	3	4	4	3	2	3	4	1
Q 21	Q22	Q23	Q24	Q25	Q26	Q27	Q28		
1	1	3	2	1	4	3	2		

**SECTION B**

Q29)

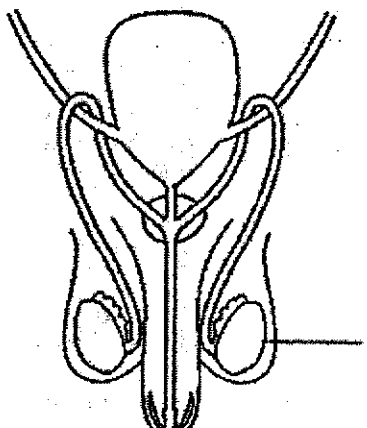

Human reproductive system

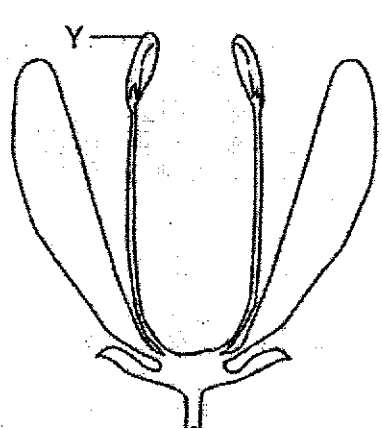

Plant reproductive system

b) Testis. It produces the male reproductive cell/sperms.

c) Female A. Only one ovary was removed. The other ovary can still function and release on egg cell to fuse with the sperm for reproduction

	to occur.
Q30)	<div data-bbox="614 347 1133 828" data-label="Image"> </div> <p>a)</p> <p>b) Ovule</p> <p>c) D. Oxygen, warmth and water are present. Lights is not needed for germination as the plant does not need to make its own food, it has food stored in the seed leaf.</p> <p>d)</p> <div data-bbox="438 1086 1244 1579" data-label="Figure"> </div>
Q31)	<p>a) The difference in the volume of water in beaker B is greater than beaker C. The plant in beaker B has more roots than the water in beaker C so it absorbed more water.</p> <p>b) Beaker A serves as a control set-up to compare and confirm that any change in the volume of water is solely due to the roots of the plant taking in water.</p>

Q32)	<p>a) Organ X: Gullet; Organ Z: Small intestine</p> <p>b) Mouth, stomach, small intestine</p> <p>c) Most undigested food was broken down into simpler substances by the digestive juice in organ Z and absorbed into the bloodstream.</p>
Q33)	<p>a) Respiratory system</p> <p>b) i) Carbon Dioxide ii) Water Vapour</p> <p>c) Water is absorbed from the undigested food in the large intestine of system R into the bloodstream of system R to be transported to the cells in other parts of the body.</p>
Q34)	<p>a) They help in gaseous exchange.</p> <p>b) The stomata is clogged. No gaseous exchange can take place.</p>
Q35)	<p>a) Roots</p> <p>b) Excess food</p> <div data-bbox="598 1075 1197 1590" style="text-align: center;"> <p>The diagram shows a plant with a central stem, several leaves, and a single flower at the top. The roots are depicted as a network of fibers extending into the soil. A horizontal line represents the ground surface. A label 'flower' is connected to the top of the plant by a thin line, and a label 'soil' is placed to the right of the ground line.</p> </div> <p>c)</p>
Q36)	<p>a) Leaf A – Red; Leaf B – Green</p> <p>b) Food made by leaf A accumulated above ring Y because food carrying tube was removed so the food cannot be transported downwards below ring Y.</p>
Q37)	<p>a)</p>

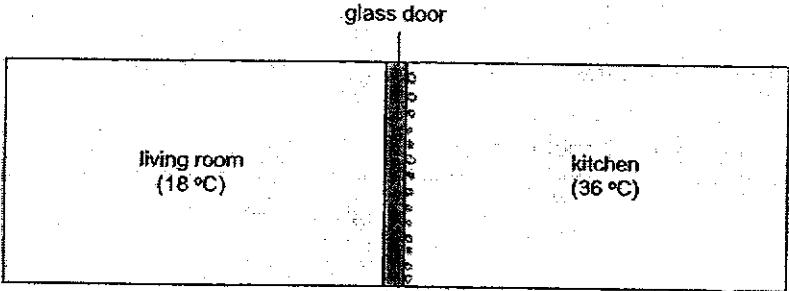
	<p>a) i)</p> <div style="text-align: center;">  </div> <p>ii) The temperature in the kitchen is higher than the temperature in the living room. The warmer water vapour in the kitchen lost heat to the cooler glass door and condensed on the glass door.</p> <p>b) The temperature difference between the living room and the kitchen has decreased. Hence, rate of condensation will be slower on the glass door.</p> <p>c) The plates on the rack will dry faster. The plates on the rack have a larger exposed surface area in contact with the surroundings. Hence the rate of evaporation will be faster.</p>
Q38)	<p>a) Three</p> <p>b) Y</p> <p>c) Opaque</p> <p>d) The size of his shadow would decrease</p>
Q39)	<p>a) The rod gained heat and expanded, piercing the balloon causing it to burst.</p> <p>b) The glass rod expanded less, thus it did not pierce through the balloon to burst it.</p> <p>c) P. For P, the increase in temperature is higher. Metal is a better conductor of heat as it gained heat from the Bunsen burner more quickly.</p>
Q40)	<p>a) i) Parallel ii) Series</p> <p>b) Bulb A. OR Bulb B</p>

Q41)

a)

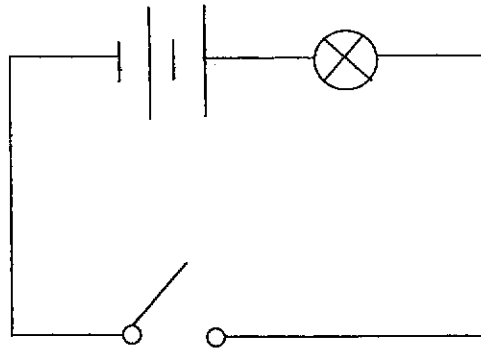

b) Paper is an insulator of electricity. When it was placed between the contacts of the switch, it formed an open circuit. Thus the electric current cannot flow through the circuit, preventing the bulb from lighting up.

c) No. The negative terminal of one battery is connected to the negative terminal of the other battery.

