

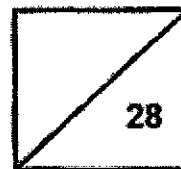

Rosyth School
Weighted Assessment One 2021
SCIENCE
Primary 5

Name: _____

Total
Marks:



Class: Pr 5- _____ Register No. _____

Total time for
Booklets A and B: 1 h

Date: 7 May 2021

Booklet A

Instructions to Pupils:

1. Do not open the booklet until you are told to do so.
2. Follow all instructions carefully.
3. This paper consists of 2 booklets, Booklet A and Booklet B.
4. For questions 1 to 14 in Booklet A, shade the correct ovals on the Optical Answer Sheet (OAS) provided using a 2B pencil.

* This booklet consists of 12 printed pages (including cover page).

This paper is not to be reproduced in part or whole without the permission of the Principal.

For each question from 1 to 14, four options are given. One of them is the correct answer. Make your choice (1, 2, 3 or 4) and shade your answer on the Optical Answer Sheet.

[28 Marks]

- 1 Jimmy prepared four set-ups, A, B, C and D, using similar plants as shown in the diagram below.

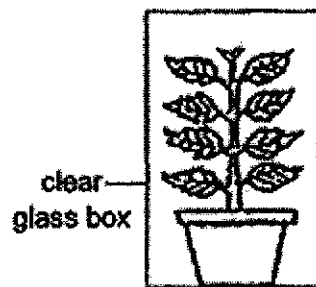

A: wet soil

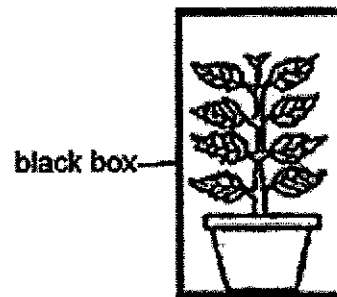

B: dry soil

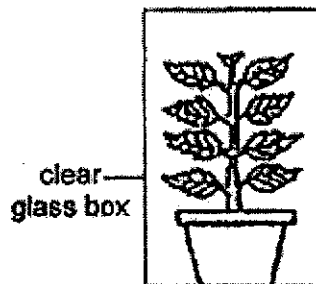

C: dry soil

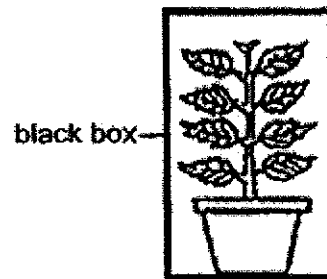

D: wet soil

Which two set-ups should Jimmy choose to find out if plant needs water to survive?

- (1) A and B
- (2) A and C
- (3) B and D
- (4) C and D

- 2 The chart below shows the similarities and differences among three living things, X, Y and Z.

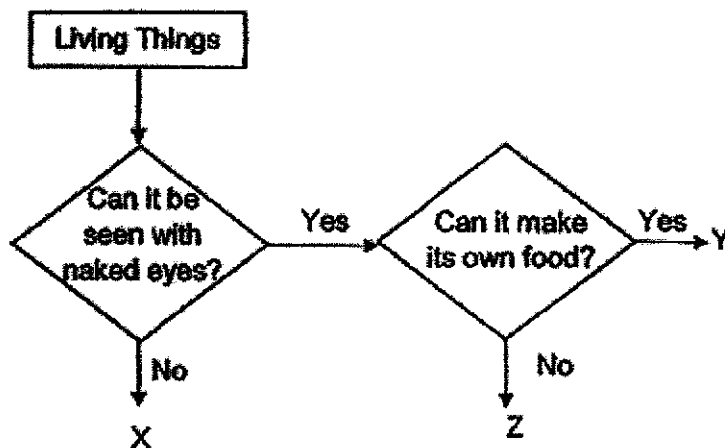

What do X, Y and Z represent?

	X	Y	Z
(1)	Yeast	Fern	Bacteria
(2)	Bacteria	Mushroom	Fern
(3)	Bacteria	Fern	Mushroom
(4)	Yeast	Bacteria	Fern

- 3 Which one of the following organ systems is matched correctly to its parts?

	Organ system	Parts of the organ system
(1)	Circulatory	heart, lungs, blood
(2)	Muscular	teeth, muscles, tongue
(3)	Respiratory	nose, gullet, lungs
(4)	Skeletal	skull, backbone, ribcage

- 4 Organ A and organ B are connected to each other in the human digestive system. The diagram below shows only the absorption of water from the digestive system into the circulatory system.

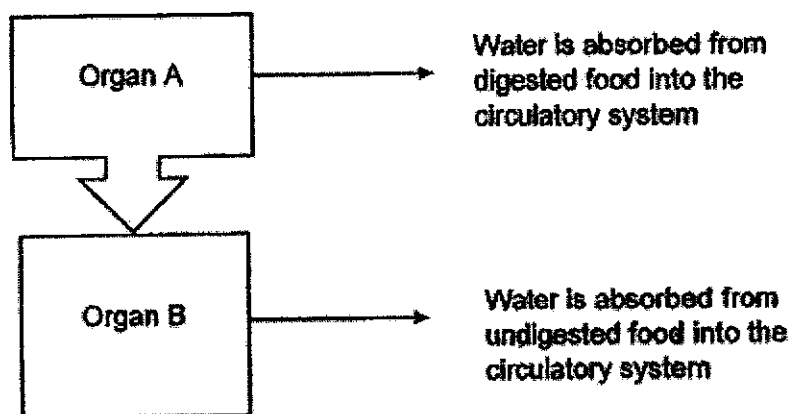

Based on the information given, organ A is the _____.

- (1) mouth
- (2) stomach
- (3) small intestine
- (4) large intestine

- 5 Some men were trapped in a lift. Which one of the following graphs shows the changes in the amount of gases in the room?

(1)

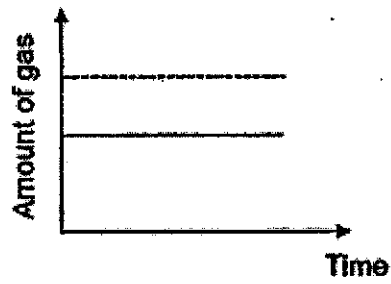

Key:

— carbon dioxide

— oxygen

(2)

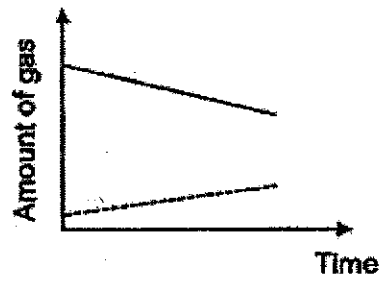

(3)

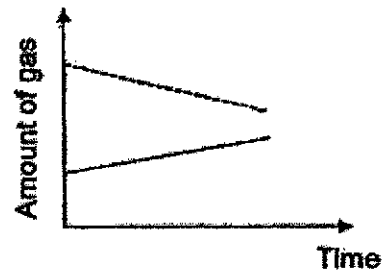

(4)

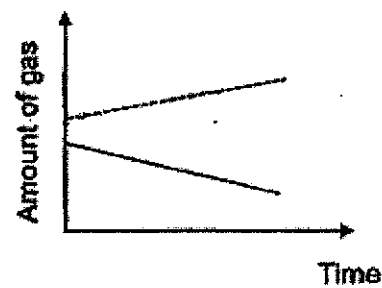

- 6 The diagram below shows the flow of blood in certain parts of the human body.

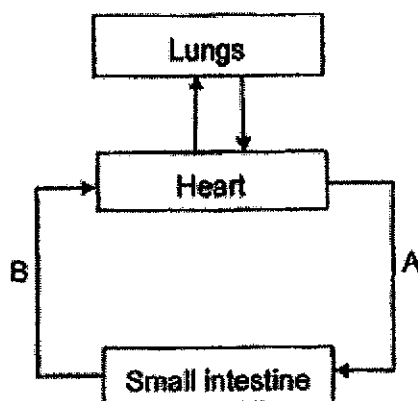

Which one of the following shows the amount of digested food and carbon dioxide in blood at A and B respectively when a person has just completely digested his food?

	Amount of digested food in		Amount of carbon dioxide in	
	A	B	A	B
(1)	High	Low	High	Low
(2)	Low	High	Low	High
(3)	Low	High	Low	Low
(4)	High	Low	Low	High

- 7 Which of the following substance(s) is/are not transported by the stem in a plant?

A: food
 B: water
 C: mineral salts
 D: carbon dioxide

- (1) C only
 (2) D only
 (3) C and D only
 (4) A, B and C only

- 8 Ally removed a layer of bark from a healthy plant at two positions, X and Y. The layers removed are of different depths. The two positions are as shown below.

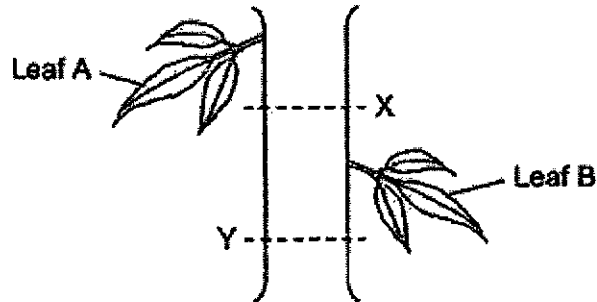

Which one of the following shows the tube/tubes removed at the two positions, X and Y, and the condition of the leaves, A and B, after a week?

	Tube removed at		Leaf	
	X	Y	A	B
(1)	Food-carrying tube only	None of the tubes are removed	Green	Green
(2)	None of the tubes are removed	Food-carrying and water-carrying tubes	Green	Withered
(3)	None of the tubes are removed	Food-carrying tubes only	Green	Withered
(4)	Food-carrying and water-carrying tubes	Food-carrying tube only	Green	Green

- 9 The diagram below shows a young seedling.

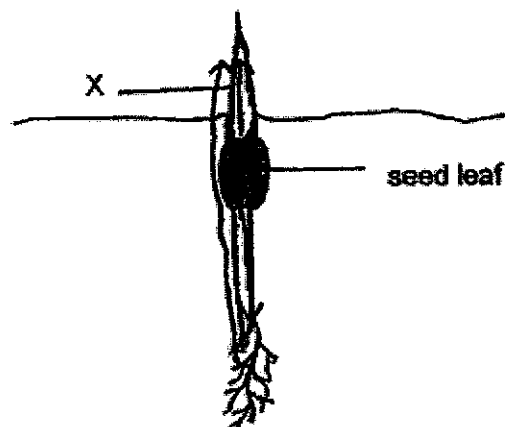

In which direction is food and water being transported at X respectively?

	Direction for transport of	
	food	water
(1)	upwards	upwards
(2)	upwards	downwards
(3)	downwards	upwards
(4)	downwards	downwards

- 10 Siew Fen saw a lady putting one paper bag inside another paper bag as shown below before putting her things inside.

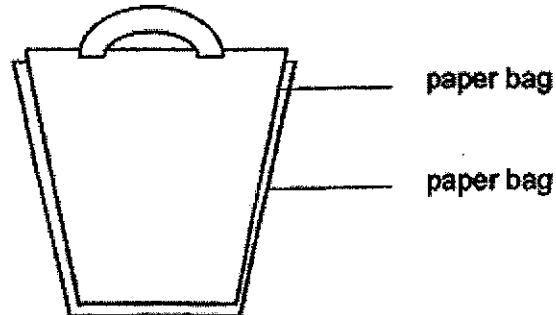

Which property of the paper bag is she trying to increase?

- (1) Strength
 - (2) Flexibility
 - (3) Waterproof
 - (4) Transparency
- 11 The diagram below shows an electrical system made of different objects.

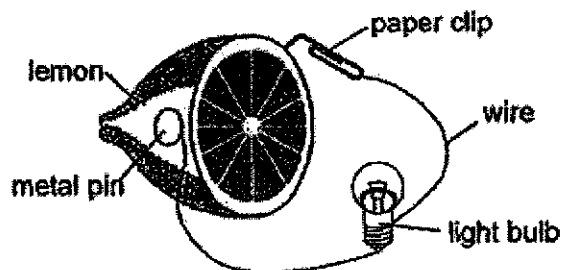

Which is the energy source of the electrical system above?

- (1) lemon
- (2) metal pin
- (3) light bulb
- (4) paper clip

- 12 The diagram below shows four bulbs A, B, C, D and two batteries connected in a circuit.

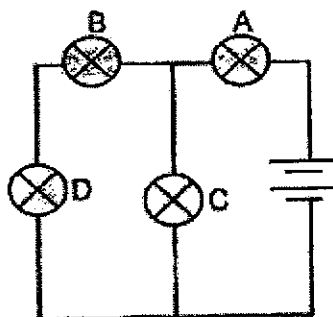

When one of the bulbs fused, the other three bulbs will remain lit.
Which bulb is fused?

- (1) A
- (2) B
- (3) C
- (4) D

Rosyth School/Weighted Assessment One/Science/P5/2021

- 13 All the bulbs and batteries in the three circuits below are identical and are in working conditions. A, B, C and D are materials which are either electrical conductor or insulator.

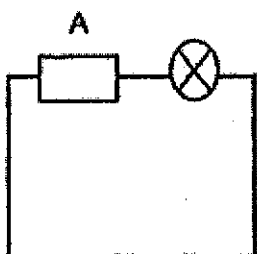

Bulb does not light up

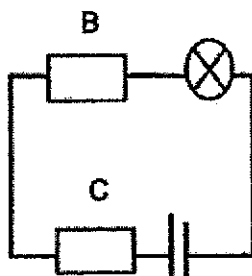

Bulb lights up

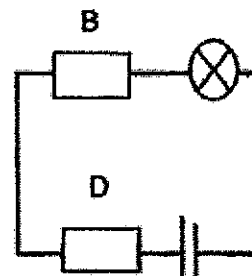

Bulb does not light up

Which of the following materials is/are definitely an electrical insulator ?

- (1) C only
- (2) D only
- (3) A and D only
- (4) B and D only

- 14 Ziming set up two identical bulbs in his toy house. Bulb X is in Room 1 and Bulb Z is in Room 2. The brightness of each room is the same.

The two rooms are separated by a wall as shown below.

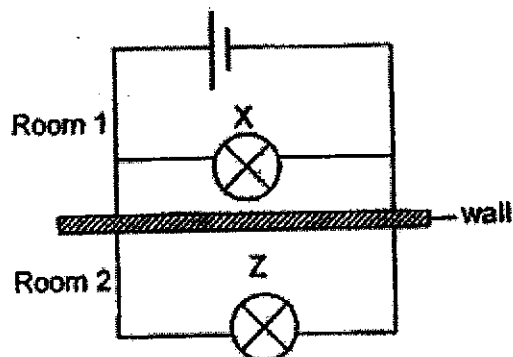

He wanted Room 2 to be brighter than Room 1.

What should he do?

- (1) Add in a bulb in series to bulb Z.
- (2) Add in a bulb in parallel to bulb Z.
- (3) Add in more batteries in the circuit.
- (4) Add in an electrical conductor in series to bulb Z.

(Go to booklet B)



Rosyth School
Weighted Assessment One 2021
SCIENCE
Primary 5

Total
Marks:

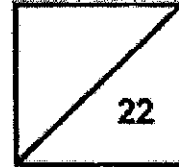

Name: _____

Class: Pr 5- _____

Register No. _____

Total time for
Booklets A and B: 1 h

Date: 7 May 2021

Parent's Signature: _____

Booklet B

Instructions to Pupils:

For questions 15 to 20, write your answers in the spaces given in this booklet.

	Maximum	Marks Obtained
Booklet A	28 marks	
Booklet B	22 marks	
Total	50 marks	

* This booklet consists of 9 printed pages (including cover page).

This paper is not to be reproduced in part or whole without the permission of the Principal.

For questions 15 to 20, write your answers in the space provided.

[22 Marks]

- 15 Liquid X is similar to the digestive juice found in the stomach. Amin prepared the two set-ups as shown below using similar-sized foods, A and B. He was investigating the rate of digestion for foods, A and B. He recorded the results of his experiment after an hour.

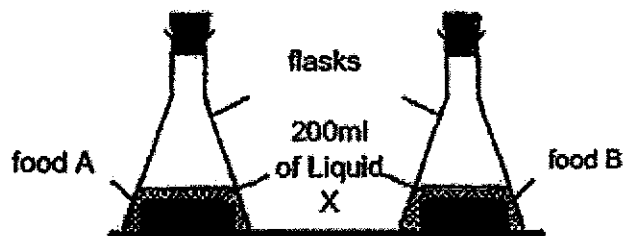

He concluded that food A digested faster than food B in liquid X.

- (a) What would be the evidence to support the above conclusion? [2]

Amin wanted to find out what is the best temperature for digesting food A in liquid X.

He prepared three experimental set-ups with liquid X at 20°C, 30°C and 40°C respectively. Using the results, he concluded that the best temperature for food A to be digested is at 30°C.

- (b) His teacher asked him to prepare another set-up with liquid X at 37°C. Explain why that set-up is needed. [1]

- 16 Sam carried out an experiment to find out how the number of leaves on a plant affects the rate of absorption of water by the plant. He placed two similar plants in identical beakers, each containing the same amount of water as shown in the diagram below.

He then placed the two set-ups next to a window for five days.

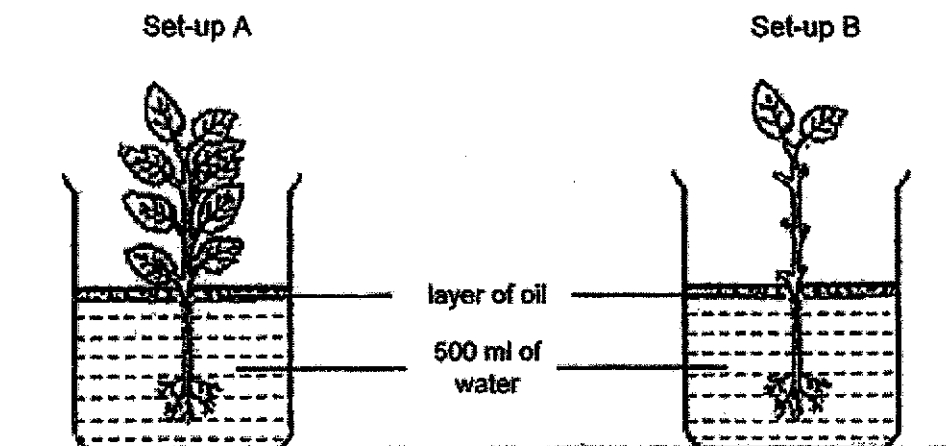

He recorded part of his experimental results in the table below.

Day	Volume of water left in the beaker (ml)	
	Set-up A	Set-up B
0	500	500
2	450	490
4	400	470

- (a) State the changed variable in this experiment [1]

- (b) What can Sam do to make the results more reliable? [1]

Question 16 continues on page 4

(c) The picture below shows a tree that has shed its leaves during the dry season.

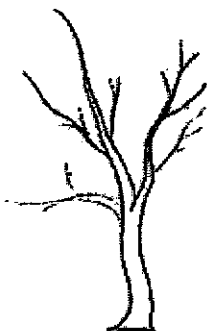

Using the results, explain how shedding its leaves would help the plant. [2]

17 David hung a magnet A, 30cm away from a magnetic material B.

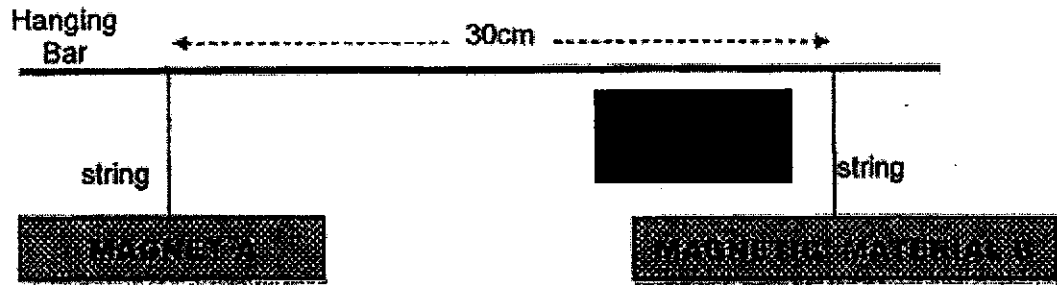

(a) He observed that magnet A and the magnetic material B were not attracted to each other. Explain why. [1]

(b) Then he hung object X in between magnet A and magnetic material B as shown below.

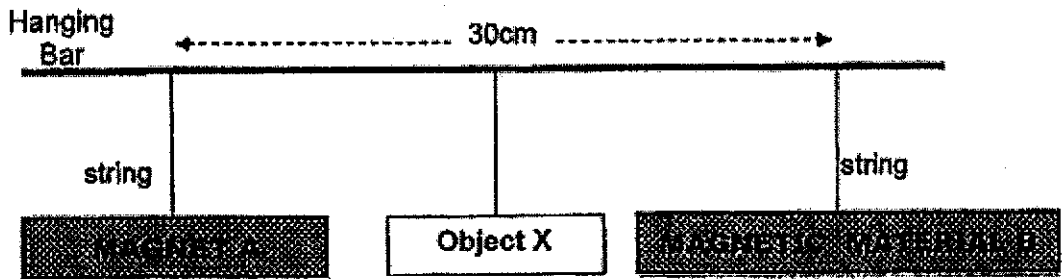

If object X is a magnet hung in between A and B, what would possibly happen to A and B? Draw in the box given below to show one possible result. (Label all the magnetic poles in your drawing.) [2]

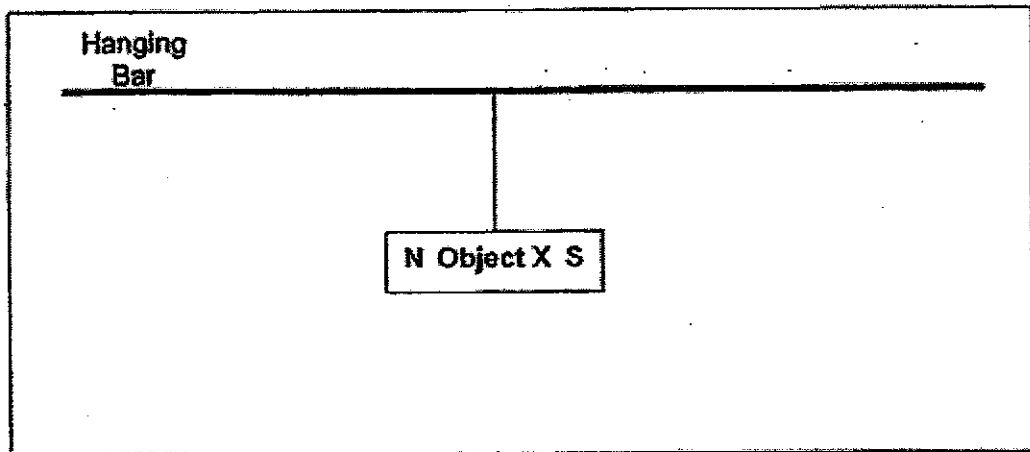

- 18 Ben wants to set up a circuit to light up his toy building as shown below using identical bulbs and batteries.

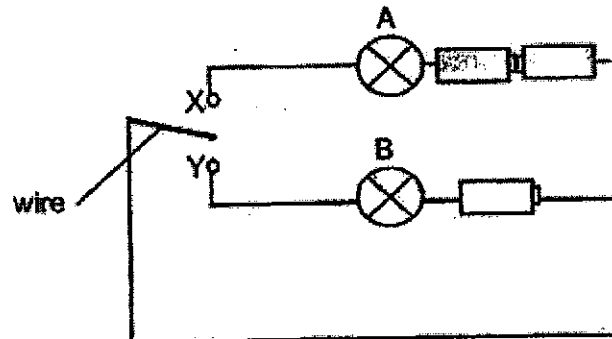

Study the circuit above and answer the following questions.
State if statements 1 and 2 are true or false and give the reasons. [3]

Statement 1 : When the wire is at X, bulb A will light up.

Tick : True False

Reason for your choice: _____

Statement 2 : When the wire is at Y, bulb B will light up.

Tick : True False

Reason for your choice: _____

19 Mary set up a circuit using two bulbs and a battery.

She wants the following condition to be met.

There are two pathways for the electrical current to flow.

(a) Complete the circuit below.

[2]

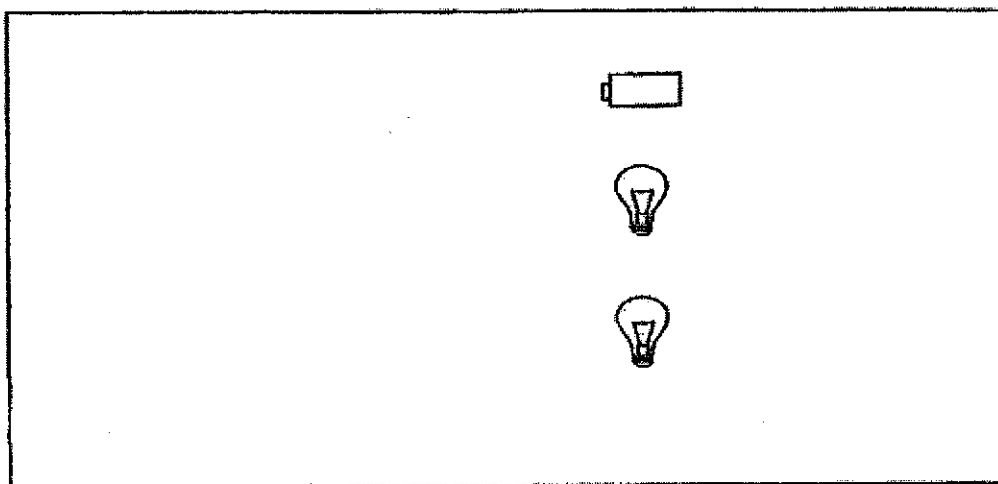

(b) State one disadvantage of the above circuit .

[1]

(c) Suggest how the two bulbs can be controlled independently.

[1]

- 20 Ruth sets up an electric circuit using a bulb and two batteries as shown below.

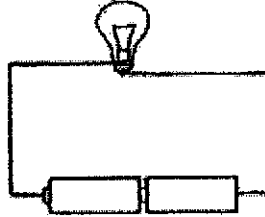

She wants to find out how the number of bulbs arranged in series will affect the brightness of each bulb.

- (a) To ensure a fair test, state one variable she must keep constant. [1]
-

- (b) The graph below shows the relationship between the number of bulbs arranged in series in the circuit and the brightness of the bulbs.

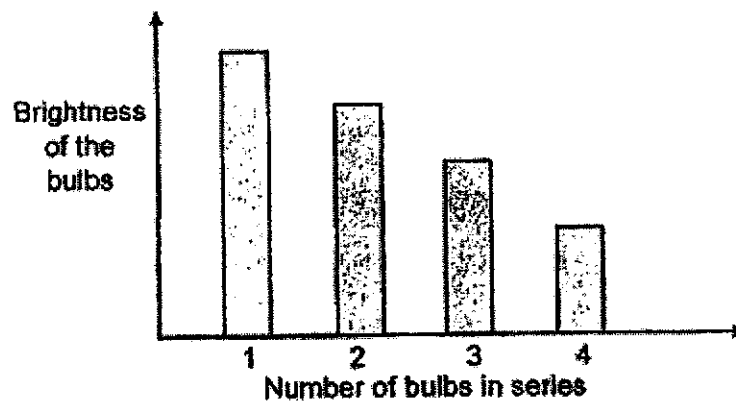

From the graph above, state the relationship between the number of bulbs arranged in series and the brightness of the bulbs. [1]

Question 20 continues on page 9

- (c) Ruth carried out the experiment in a dark room.

Explain how carrying out the experiment in a dark room helped to make the experiment accurate. [1]

- (d) Ruth saw a notice as shown below.

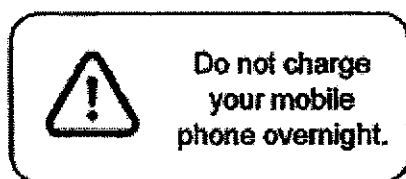

Explain the reason for the above notice. [2]

End of Paper

SCHOOL : ROSYTH PRIMARY SCHOOL
LEVEL : PRIMARY 5
SUBJECT : SCIENCE
TERM : 2021 WA1

SECTION A

Q 1	Q2	Q3	Q4	Q5	Q6	Q7	Q8	Q9	Q10
2	3	4	3	2	2	2	1	1	1
Q11	Q12	Q13	Q14						
1	3	2	2						

P5 WA1 2021

	Suggested answers	Not accepted
15a	<p>Compare size of food Time factor</p> <p>Food A <u>was smaller size than food B(1) after a certain time/an hour/end of experiment of</u></p> <p><u>Food A is completely digested while there is still some food B left undigested after a certain time/an hour/end of experiment</u></p>	
b	<p><u>37°C is the body temperature thus it can be used to compare and confirm if 30°C is the best temperature for food A to be digested.</u></p>	<p>It is a control set-up</p> <p>To find out if in between 30 deg C and 40 deg C there was a better temperature than 30 deg C. (0)</p>
16a	<p>The number of leaves on the plant</p>	
b	<p>He can repeat the experiment a few times.</p>	<p>Prepare a control set-up with a plant that has no leaves</p> <p>Repeat the experiment a few more days.(0)</p>
c	<p>Answer must relate to experimental data</p> <ul style="list-style-type: none"> • Less leaves, less water absorbed • Talks about survival with less water <p><u>Less leaves that the plant has, the less water is taken in by the plant.(1m) thus the plant can survive with less water (1m) during a dry season</u></p>	
17a	<p>(Magnet A is far away from B) and <u>its magnetic force is not strong enough to attract B.</u></p> <p>Or</p> <p>Magnet A did not have enough magnetic strength to attract B from 30cm</p>	<p>Magnetic 'power'/energy instead of 'force'?(0)</p> <p>Magnet A is a weak magnet -->not explicit enough</p>
18a	<p>Statement 1:</p> <p>False (1/2m)</p>	<p>Tick wrongly but reason correct(0)</p> <p>Both batteries are <u>facing each other(0)</u></p> <p>The positive terminals of the batteries are facing each other, <u>so the batteries</u></p>

	<u>Bulb A will not light up because the batteries are not connected in the correct way (thus there is no electrical current flowing through the circuit).</u>	<u>cancels out and serves as electrical conductors only-->wrong concept(0).</u>
b	Statement 2: True (1/2m) <u>There is a closed circuit so current/electricity can flow through bulb B.</u>	The circuit has a bulb, battery and wires and all the batteries are connected to each other(0)
19a	Bulbs connected in parallel - 1m Bulbs connection correct - 1m	
b	The circuit draws more current (1) The battery uses up the energy faster.(1) The battery will not last long/ be used up faster.(1)	Batteries will need to change often.(0)
c	By adding a switch next to each bulb in the circuit.	Adding switch/ two switches without details of location
20a	Number / Voltage of batteries Number / Length/ material/Thickness of wires Voltage of bulbs	Type of batteries/ type of wires/type of bulbs Brand of.... Number of bulbs(0)
b	As the number of bulbs arranged in series <u>increases</u> , the brightness/light intensity of the bulbs <u>decreases</u> . The greater the number of bulbs, the dimmer/brighter the bulbs is	
c	Evidence: <u>No other light sources from the surroundings can interfere/affect the results/experiment.</u> (0.5m) Reasoning: so the difference in the brightness of the bulbs can be measured in a dark room precisely/clearer/distinctly/accurately. (0.5m)	To compare and confirm that number of bulbs is the only variable affecting the brightness of the bulb It is a fair test
d	Charging her phone overnight might produce <u>too much heat</u> /cause <u>overheating</u> (1m) and hence the phone may <u>catch fire</u> . (1m)	It can cause a short circuit.(0) Too much electric current causes the battery to fuse(0)

