



AI TONG SCHOOL
2007 SEMESTRAL ASSESSMENT (1)
PRIMARY FIVE SCIENCE

DURATION : 1HR 45 MIN
DATE : 15 MAY 2007

INSTRUCTIONS

Do not open the booklet until you are told to do so. Follow all instructions. Answer all questions.

Name : _____ ()

Class : Primary 5 _____

Parent's Signature : _____

Date : _____

Total	
	100

Section A

Read the questions carefully and shade its number (1, 2, 3 or 4) using the Optical Answer Sheet (OAS)

1. If an object moves round the Earth, it would be called a _____.
 - (1) star
 - (2) moon
 - (3) satellite
 - (4) planet

2. The Sun appears to be moving across the sky when it rises in the east and when it sets in the west because the _____.
 - (1) Sun revolves round the Earth
 - (2) Sun rotates on its own axis
 - (3) Earth rotates on its own axis
 - (4) Earth revolves round the Sun

3. At 8p.m., Andy called his father who was in London. He was surprised to hear from his father that it was morning over in London.

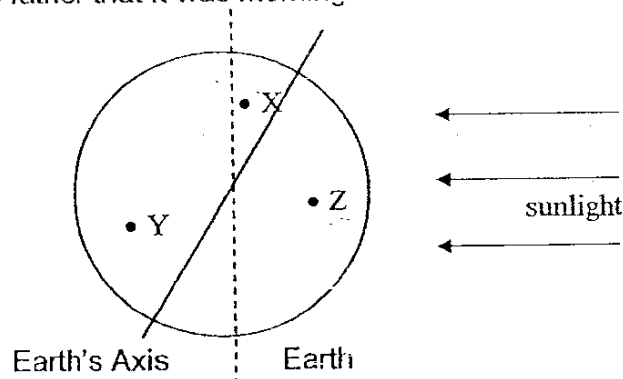

At which position, X, Y and Z would Andy and his father most probably be respectively at that time?

	Andy	His Father
(1)	X	Y
(2)	Y	X
(3)	X	Z
(4)	Y	Z

97

4. A communication satellite _____
- (1) connects telephone wires together
 - (2) helps to store information for telephone companies
 - (3) receives and sends messages from one place to another
 - (4) travels across countries to receive and send telephone messages
5. A single-cell animal called an amoeba divides to form two cells after one cell division. After a second cell division, the two cells form four cells. This process can go on and on. How many amoebae were there at first if there were 32 amoebae after 3 cell divisions?
- (1) 3
 - (2) 4
 - (3) 6
 - (4) 8

6. The table below shows how some living things are classified.

Group A	Group B
Yeast	Lizard
Amoeba	Parrot
Paramecium	Earthworm

How are the living things grouped?

Whether they _____

- (1) are fungi or animals
 - (2) are living or non-living things
 - (3) are single-cell organisms or multi-cell organisms
 - (4) carry out cell division or not
7. Our cells contain genes which carry information about us. These genes are found in the _____ of the cells.
- (1) nucleus
 - (2) cytoplasm
 - (3) chloroplast
 - (4) cell membrane

8. Simon has an identical twin brother, Seth. Which one of the following about Simon and Seth is true?

- (1) Their parents are twins.
- (2) Their features are identical to their parents.
- (3) They are reproduced from budding.
- (4) The nuclei of their cells contain identical materials.

9. The diagram below illustrates a process carried out by 2 flowers of the same species.

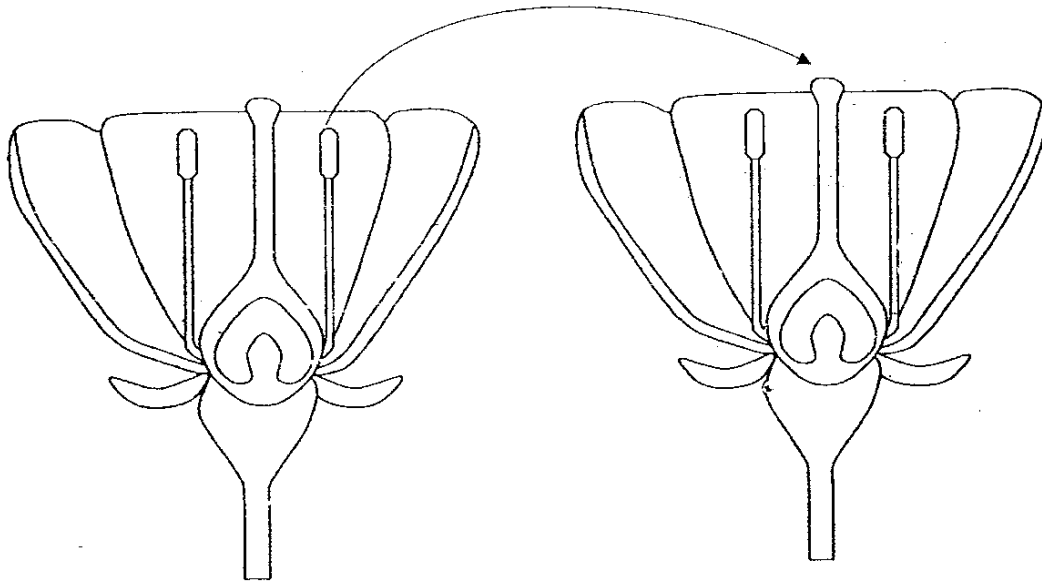

The process ensures _____.

- (1) germination after the process
- (2) that the fruits formed will be sweeter
- (3) that the flowers are attractive to pollinators
- (4) the continuity of the same kind of flowers

10. During a field trip, Rachel came across an interesting plant. The plant was short and produced small, red fruits that were soft and juicy. Based on Rachel's observation, these fruits are likely to be dispersed by _____.

- (1) water
- (2) wind
- (3) animals
- (4) splitting

11. The diagram below shows a cross-section of an onion.

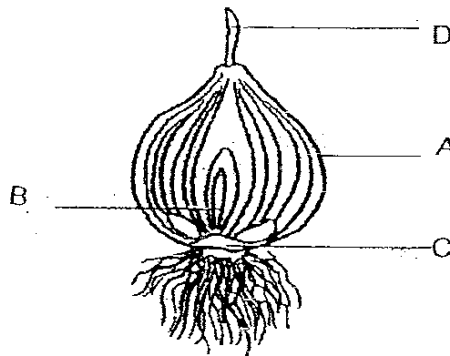

Which part, A, B, C or D, is the stem?

- (1) A
- (2) B
- (3) C
- (4) D

12. The diagram shows part of an island where two types of plants (◇, ☆) are growing.

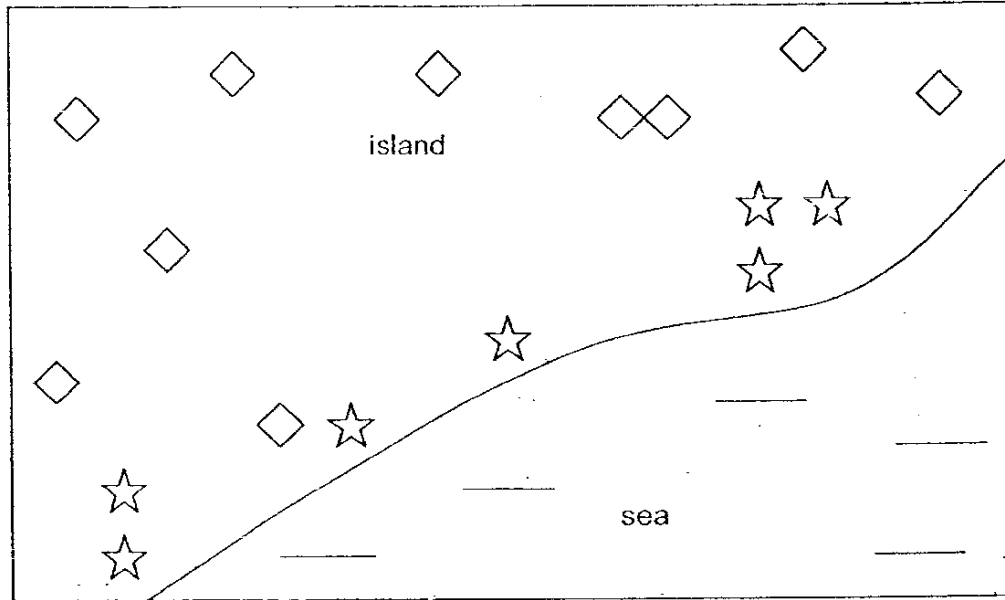

How are the fruits or seeds of each type of plant most likely dispersed?

	◇	☆
(1)	Water	Animals
(2)	Splitting action	Wind
(3)	Wind	Water
(4)	Animals	Splitting action

13. A potato cannot reproduce new plants if all the _____ are cut off.

- (1) roots
- (2) stems
- (3) scaly leaves
- (4) buds

14. This diagram shows how carbon dioxide is added to and removed from the air during the processes such as P and Q.

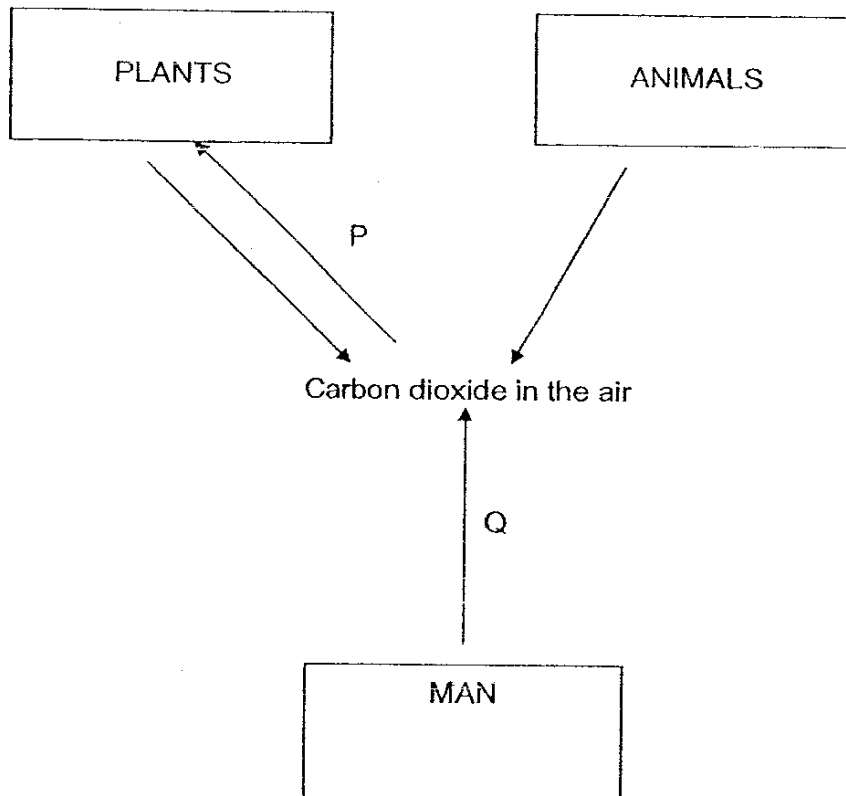

What are processes P and Q?

	P	Q
(1)	Reproduction	Photosynthesis
(2)	Decomposition	Breathing
(3)	Respiration	Decomposition
(4)	Photosynthesis	Respiration

15. The diagram below shows 3 kinds of fruits.



Shorea

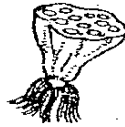

Lotus



Mangrove

Which of these fruits are most likely to be dispersed by water?

- (1) Shorea and Lotus
- (2) Shorea and Mangrove
- (3) Lotus and Mangrove
- (4) Shorea, Lotus and Mangrove

16.



In the diagram above, what method of dispersal is taking place?

- (1) Water
- (2) Wind
- (3) Animal
- (4) Explosive action

17. A ray of light falls on a mirror. Which of the following diagrams shows the correct path taken by the reflected ray?

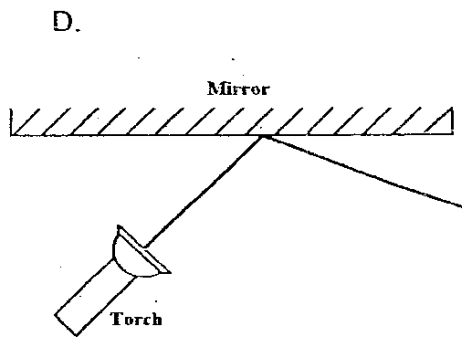
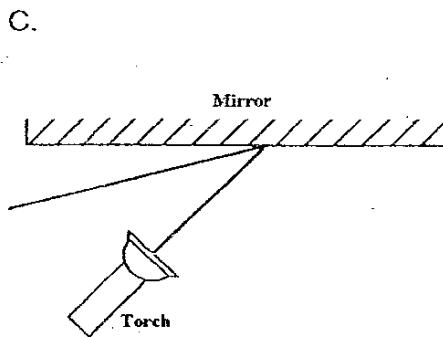
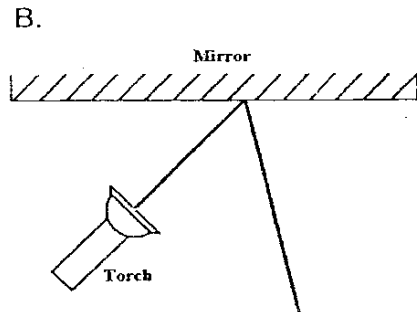
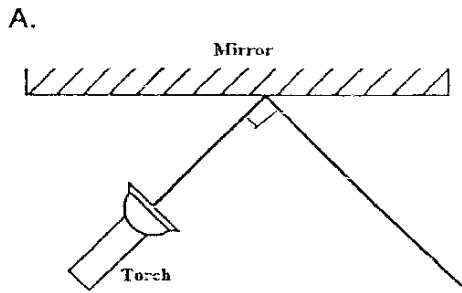

- (1) A
- (2) B
- (3) C
- (4) D

104

18. How many weeks does a human baby take to develop in the mother's womb?
- (1) 28
 - (2) 38
 - (3) 48
 - (4) 58
19. When a male and female sex cell fuse inside the body of a female animal, the process is called _____.
- (1) external fertilisation
 - (2) internal fertilisation
 - (3) asexual reproduction
 - (4) cross-pollination
20. Margaret carries out an experiment by filling three beakers with an equal volume of liquids X, Y and Z as shown in the diagram. She places the beakers side by side in the open, where it is sunny and windy.

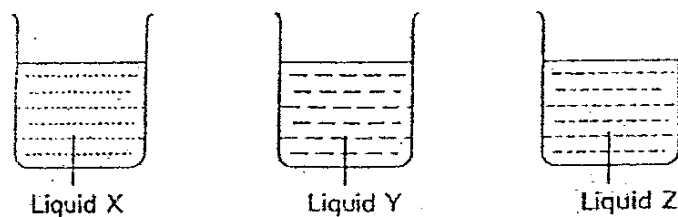

After a few hours, she records the volume of liquid remaining in each of the three beakers.

The aim of the experiment is to find out _____.

- (1) if the rate of evaporation depends on the temperature
- (2) if liquid evaporate faster at a higher temperature
- (3) if different liquids evaporate at different rates
- (4) whether the liquids evaporate when there is wind

21. Although they are sisters, Joyce can roll her tongue but Mabel cannot. What is the explanation for this?

- (1) Mabel did not practice rolling her tongue.
- (2) Mabel has a shorter tongue than Joyce.
- (3) One of their parents can roll the tongue.
- (4) The ability to roll the tongue cannot be inherited.

22. Which event is caused by the Earth moving round the Sun?

- (1) Leaves of raintree closing
- (2) Sunrise and sunset
- (3) Change of seasons
- (4) Sunflowers turning to the Sun

23. The graph below shows the amount of carbon dioxide in the air around a tree. A, B, C and D represent the time over a period of 24 hours.

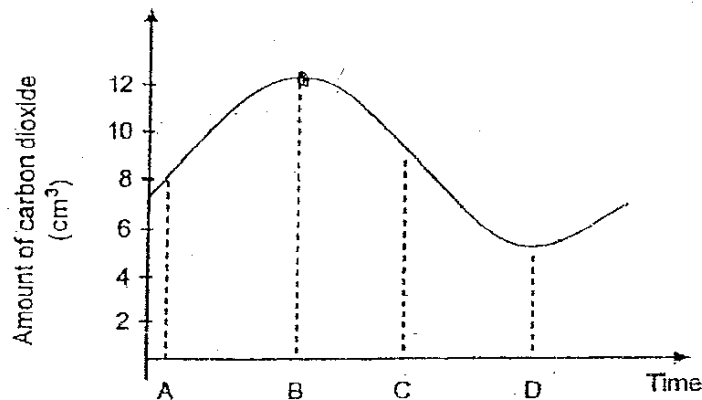

Which of the following shows the correct time for A, B, C and D?

	A	B	C	D
(1)	6 a.m.	12 noon	6 p.m.	12 midnight
(2)	6 p.m.	12 midnight	6 a.m.	12 noon
(3)	12 noon	6 p.m.	12 midnight	6 a.m.
(4)	12 midnight	6 a.m.	12 noon	6 p.m.

24. ~~The food web below has some missing plants or animals.~~

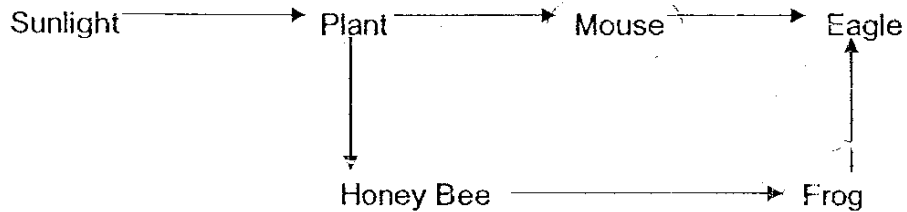

Which animal in the diagram depends only on a plant-eater as a direct source of energy?

- (1) Mouse
- (2) Eagle
- (3) Frog
- (4) Honey Bee

25. A funnel is tightly fitted with a stopper at the mouth of the bottle as shown in the diagram below.

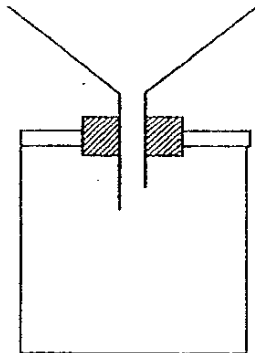

Which one of the following explains why water does not flow into the bottle when it is poured into the funnel?

- (1) The stopper prevents the water from flowing in.
- (2) There is no opening for the water to flow in.
- (3) The stem of the funnel is too narrow for water to flow in.
- (4) The air in the bottle cannot escape.

26. Four beakers of water of different temperatures A, B, C and D were placed in an air-conditioned room.

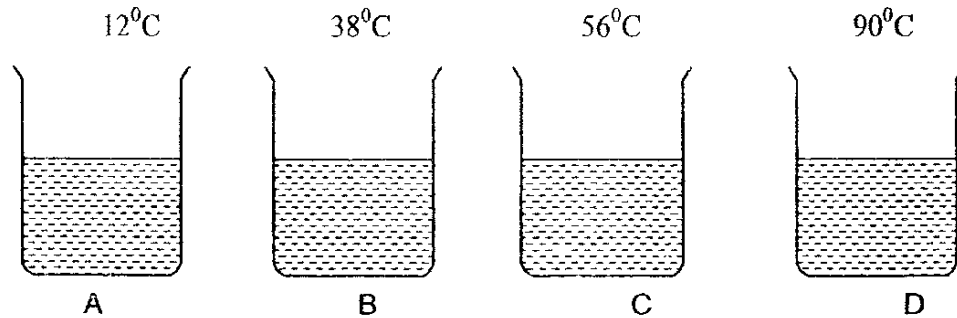

Which one of the beakers would you see water droplets forming on its outer surface after 10 minutes?

- (1) ~~(5)~~ A
(2) ~~(6)~~ B
(3) ~~(7)~~ C
(4) ~~(8)~~ D

27. Which of the following processes ensures the continuity of the water cycle?

- A Boiling
B Evaporation
C Condensation

- (1) A and B only
(2) A and C only
(3) B and C only
(4) A, B and C

108

28. A conical flask is filled to its brim with coloured water and is tightly fitted with a stopper as shown in the diagram below. It is then placed in a basin of hot water. After 1 minute, the water level in the tube rises.

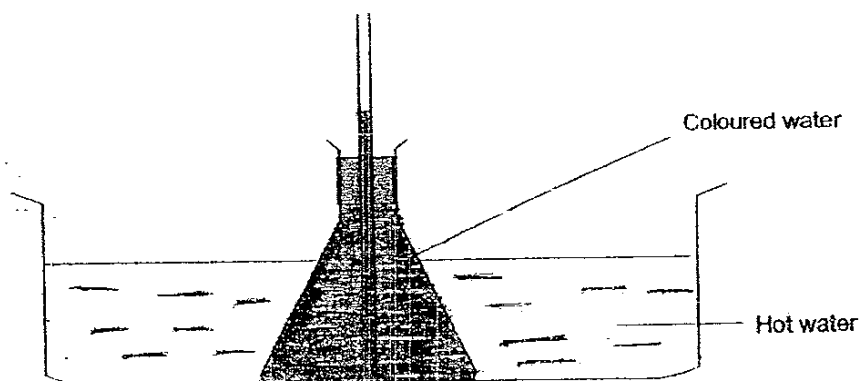

The water level in the tube rises because _____.

- (1) the conical flask contracts when heated
- (2) heat from the basin causes the water in the flask to expand
- (3) heat from the basin causes the water in the flask to contract
- (4) the water in the basin expands and enters the flask

159

29. The experiment shown below is carried out in a dark room.

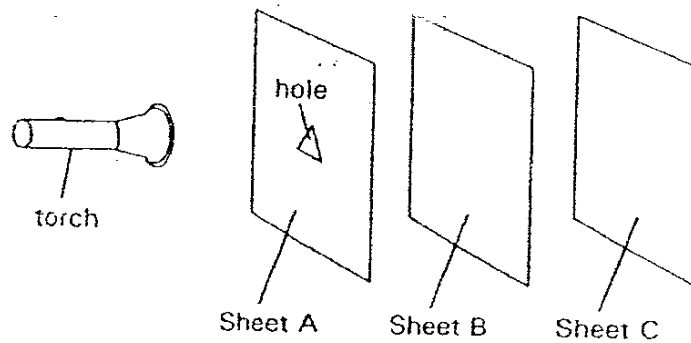

Sheets A, B and C are arranged in a straight line. When the torch is switched on, a bright triangular patch of light is seen on Sheet C only.

Which one of the following is the correct material for sheets A, B and C respectively?

	A	B	C
(1)	paper	glass	wood
(2)	glass	styrofoam	paper
(3)	styrofoam	wood	glass
(4)	glass	styrofoam	wood

110

30. The diagram below shows an experiment using three similar rods of different materials. Each rod has the same amount of wax coated at one end. The metal container is filled with hot water.

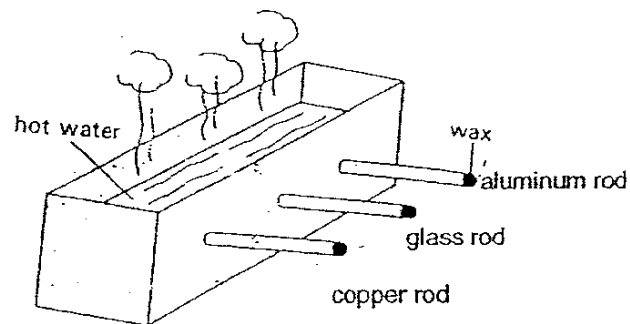

The time taken for each piece of wax to melt is taken.
Which one of the following is the correct hypothesis for the experiment?

- (1) Different rods have different temperatures.
- (2) Hot water can conduct heat very well.
- ~~(3) Wax can melt at high temperatures.~~
- (4) Some materials conduct heat better than others.

Name: _____ ()
Class P5 ()

Section B: 40 marks

Read the questions carefully and write down your answers in the spaces provided.

31. The diagram below shows the positions of some objects in the Solar System.

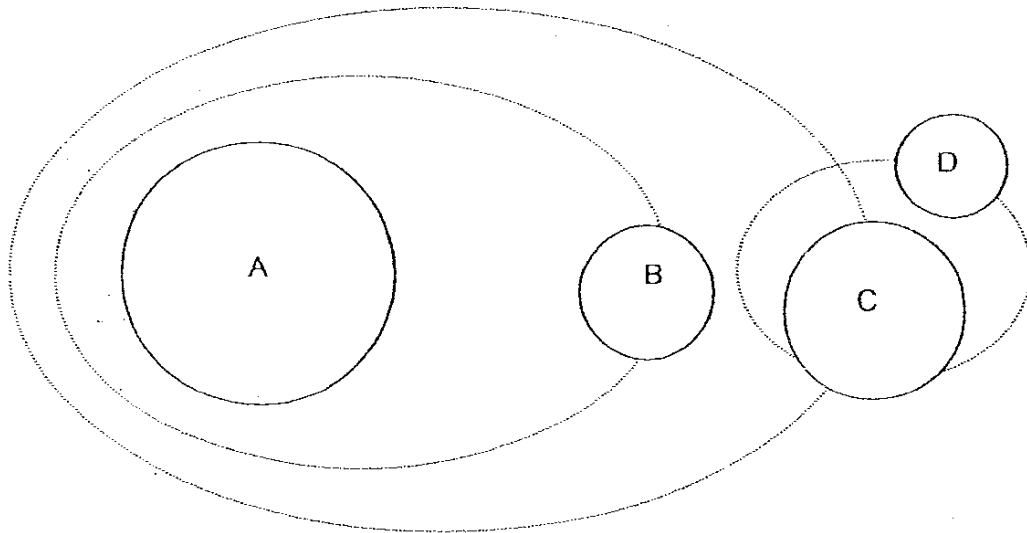

The descriptions about each object are given below.

- Object A gives out light and heat.
- Object B revolves round Object A.
- Object C revolves round Object A.
- Object D revolves round Object C.

(a) What could Object A and Object D be?

Object A : _____ [½]

Object D : _____ [½]

(b) What is the effect of Object D revolving round Object C? [1]

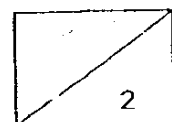

32.

(a) The moon can be seen from the Earth. Draw the correct positions of the Earth, Sun and Moon in the space below when a full moon can be seen. Label the Earth, Sun and Moon. Your drawing should show correctly :

- the relative sizes of the 3 objects
- the relative distances between the 3 objects

[2]

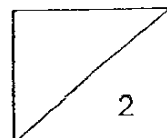
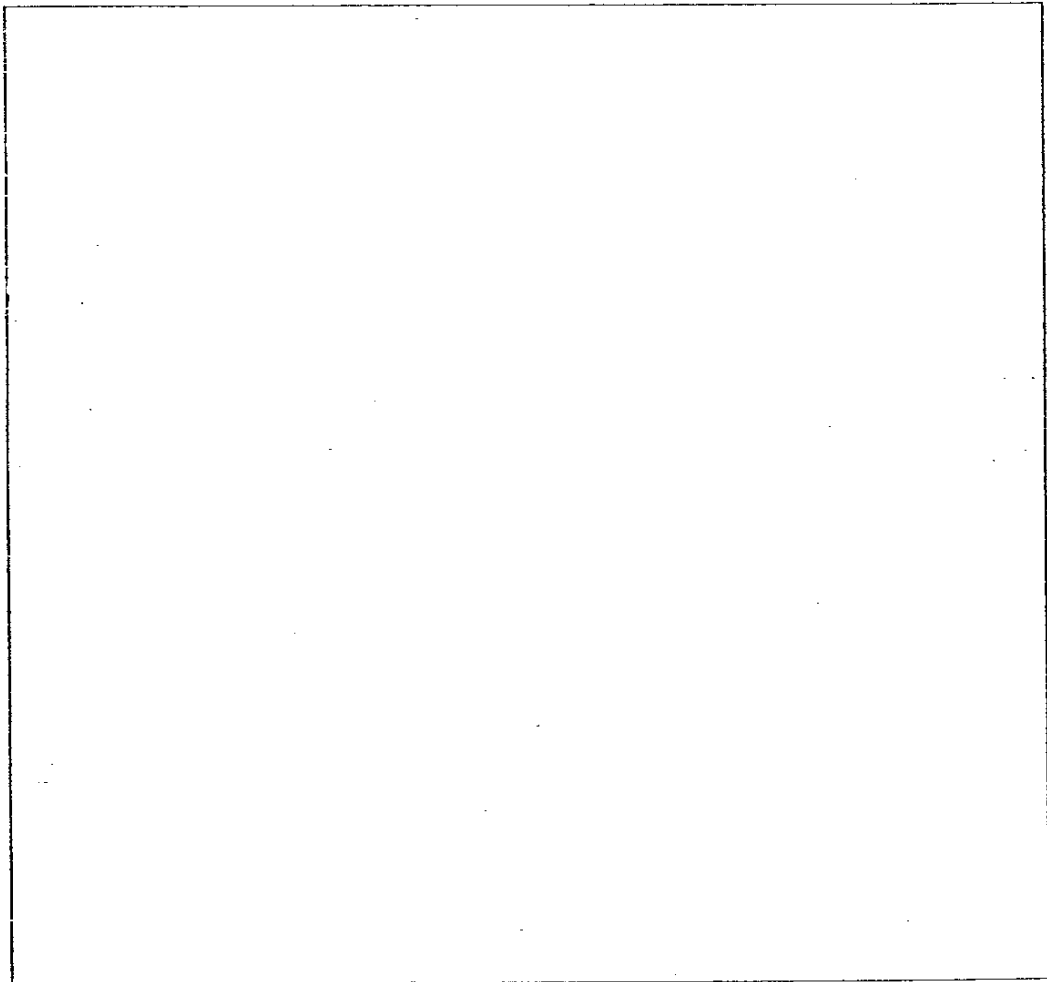

33. Susan was given 3 types of cells, Cell A, Cell B and Cell C, to observe under the microscope. She recorded her observation in the table below.

	Cell A	Cell B	Cell C
Nucleus	√	√	√
Cell Wall	x	x	√
Chloroplast	x	√	x
Cell Membrane	√	√	√

- (a) Susan made a mistake in her observation. Identify the mistake. [1]

- (b) State an example of an organism that has :

Cell A : _____ [½]

Cell C : _____ [½]

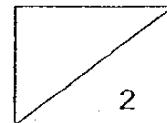

114

34. A classification chart of fruits is shown below.

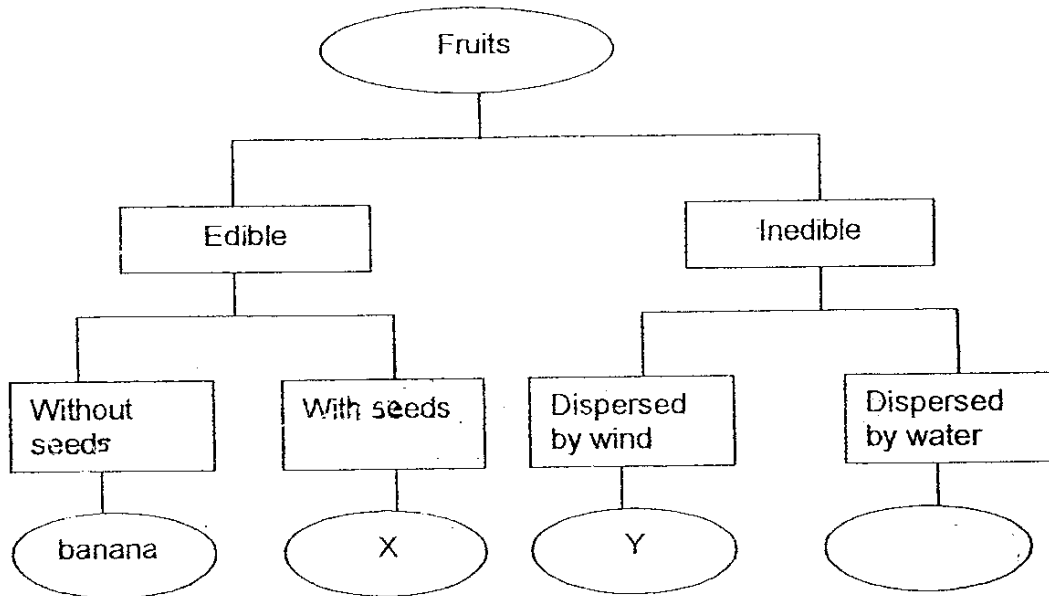

(a) Based on the chart, list two characteristics of a banana. [1]

(b) State one example of X and Y.

X : _____ [½]

Y : _____ [½]

(c) Write down one other characteristic of Fruit Y that is not shown in the chart above. [1]

145

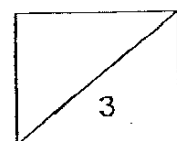

35. The diagram below shows Sue's family tree.

Sue's Family Tree

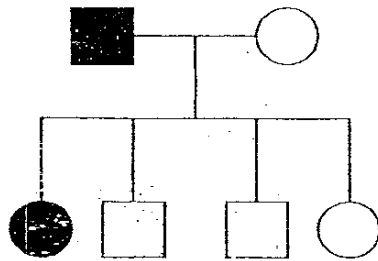

Sue

Key :



golden-haired female



black-haired female



golden-haired male



black-haired male

Write "T" for the statements that are true and "F" for the statements that are false. [2]

1	Sue has golden hair.	
2	Sue has 2 brothers and 2 sisters.	
3	Three people in the family have golden hair.	
4	Sue's sister inherited her hair colour from her father.	

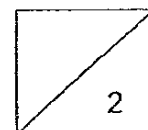

156

36. A classification table is shown below.

Group X	Group Y	Group Z
Potato	Banana	Begonia
African Violet	Pineapple	Sanseveria

(a) Which plant has been grouped wrongly? Which should be the correct grouping for the plant? [1]

(b) How are the plants grouped in this classification table? [1]

37. Jessie had a plant in her garden. After some time, she noticed some baby plants growing from a leaf as shown below.

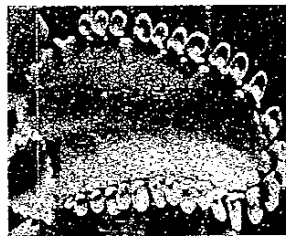

(a) Identify the plant that has the leaf shown above. [1]

(b) State one characteristic of the leaves from this plant. [1]

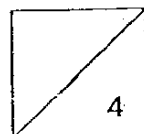

38. The diagrams below show the human reproductive systems.

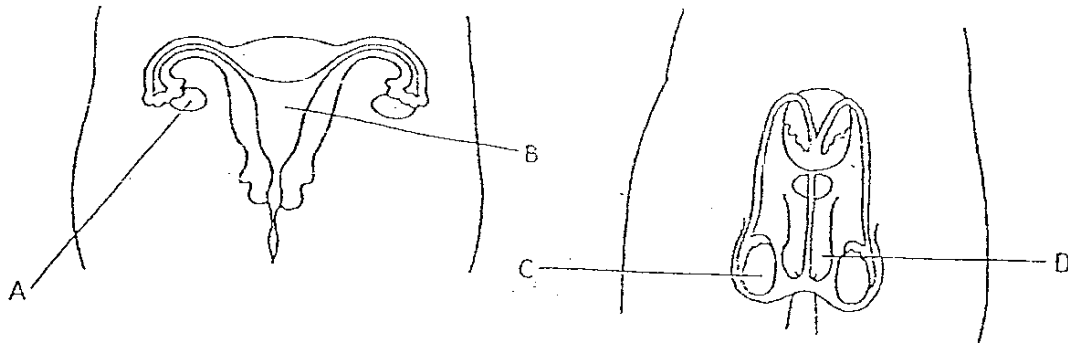

(a) Which parts, A, B, C or D produce cells that will join together to develop into a baby? [1]

(b) The developing baby in the womb is connected to the mother by an umbilical cord. State two functions of the umbilical cord. [2]

(i) _____

(ii) _____

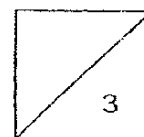

39. The picture shows a life process occurring in the body of a female.

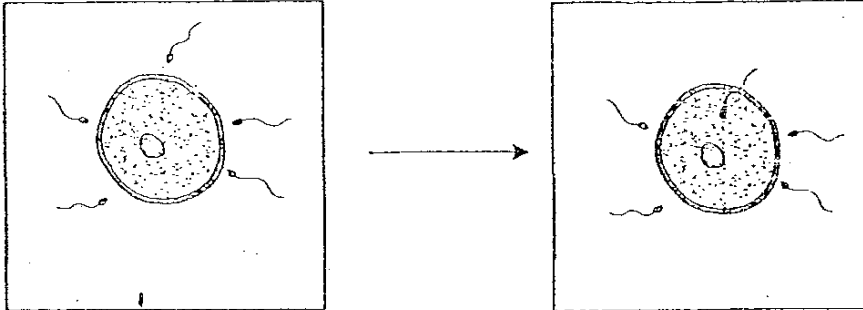

Stage 1

Stage 2

(a) What is the process that occurs in Stage 2?

[1]

(b) What will happen to the remaining sperms after Stage 2?

[1]

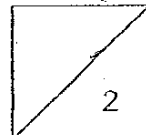

40. Complete the table below on two processes, photosynthesis and respiration. [2]

	Photosynthesis	Respiration
a) State the function of the process.	i)	i)
b) State one factor needed for the process to take place.	i)	ii)

41. The sentences below show how food is changed to energy in our body.

Sentence A : In the cells, glucose is broken down.

Sentence B : Food is eaten and digested in the digestive system.

Sentence C : The digested food enters the body cells.

Sentence D : The digested food is carried to all the cells in the body by the blood.

(a) Arrange the sentences above to show how food is changed to energy in our body. Write the letter representing the sentence in the boxes below. [1]

--	--	--	--

(b) State two end products of the process.

[2]

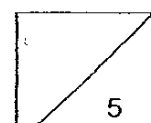

42. The food chain below shows how 3 organisms interact with one another.

Grass → Rabbit → Leopard

(a) Which organism is the food producer? [1]

(b) Where does the grass get its energy from? [1]

(c) How does a leopard depend on the grass in the food chain? [1]

07

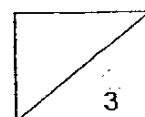

43. Mrs Tan showed Lenny the set-up of an experiment shown below. She wanted Lenny to conduct the experiment to produce a certain gas that will turn Liquid X chalky.

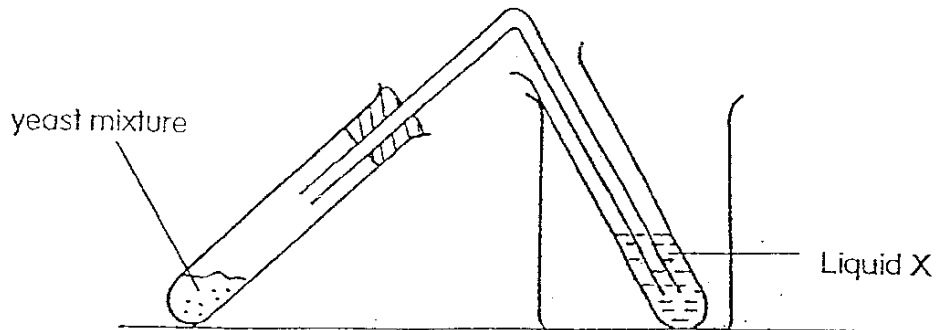

(a) Write down the steps to show how Lenny can conduct the experiment. [2]

(b) What was Liquid X?

(c) What gas was produced in this experiment?

[1]

44. Tom and Jerry carried out an experiment to find out which type of cup is better for keeping coffee hot. They poured an equal amount of hot coffee into a plastic cup and a porcelain cup of the same size. The temperature of the coffee in both cups was taken at 5 minute intervals. The results are shown in the graph below.

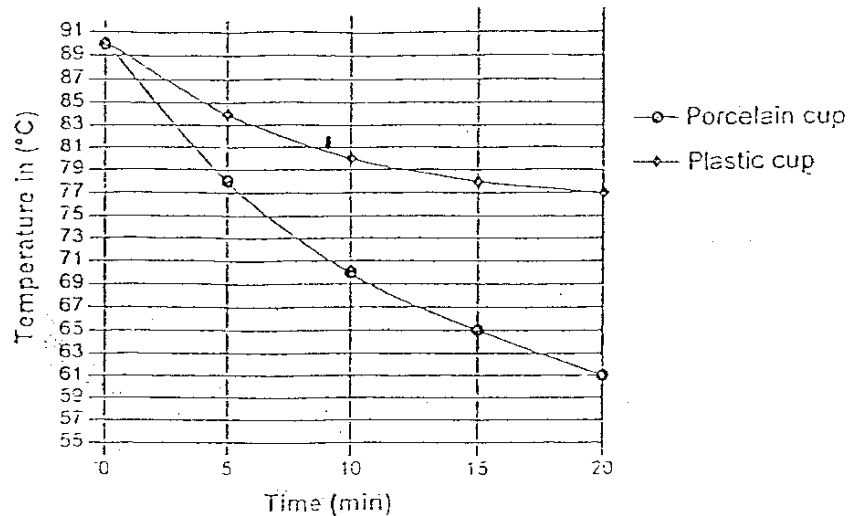

(a) What can be the boys' hypothesis for this experiment?

[1]

(b) Study the graph carefully and write down the temperature in the boxes provided.

[1]

Time (minutes)	Temperature (°C)	
	Plastic cup with coffee	Porcelain cup with coffee
0	90	<input type="text"/>
5	<input type="text"/>	78
10	80	70
15	78	65
20	77	61

(c) What can Tom and Jerry conclude about the experiment?

[1]

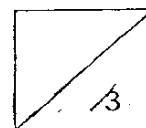

45. Jane and Roy wanted to conduct an investigation to see if the temperature of water affect how fast biscuits soften. They put a biscuit into a cup of water at 28°C as shown below.

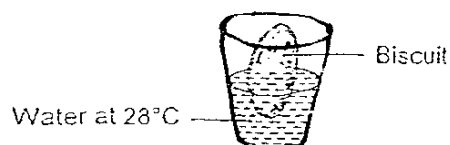

After 5 minutes, they removed the biscuit, observed it and recorded their observations. Then they repeated the experiment with water at 40°C, 60°C and 80°C. The table below shows how the variables in their experiment were controlled.

	Changed	Kept constant
Duration biscuit was placed in the cup of water	√	
Amount of water		√
Temperature of water	√	

(a) Is this a fair experiment? Explain your answer. [1]

(b) State one other variable not shown in the table that should be kept constant. [1]

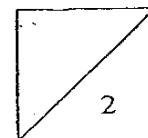

124

46. The diagram below shows a process that occurs in the nature.

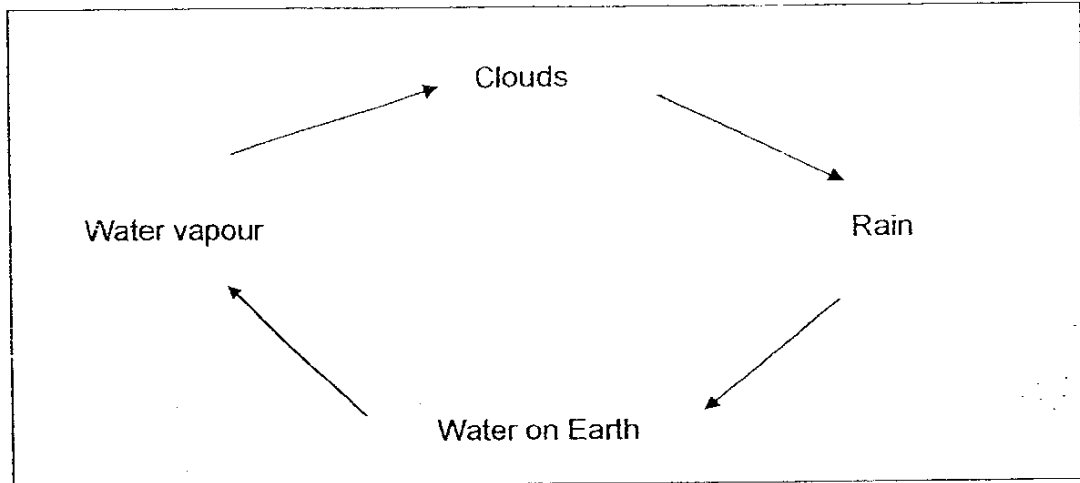

(a) Give the diagram a title.

[1]

(b) What energy enables this cycle to take place?

[1]

(c) What is the source of the energy in (b)?

[1]

125

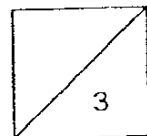

Ai Tong Primary School
Primary 5 Science SAI Exams (2007)

Answer Keys

SECTION A : (60 MARKS)

Qn no.	Ans
1	3
2	3
3	2
4	3
5	2
6	3
7	1
8	4
9	4
10	3

Qn no.	Ans
11	3
12	3
13	4
14	4
15	3
16	4
17	1
18	2
19	2
20	3

Qn no.	Ans
21	3
22	3
23	2
24	3
25	4
26	1
27	3
28	2
29	1
30	4

SECTION B (40 MARKS)

- 31a. **A: Sun D: Moon**
 31b. **It will cause high tide and low tide.**

32.

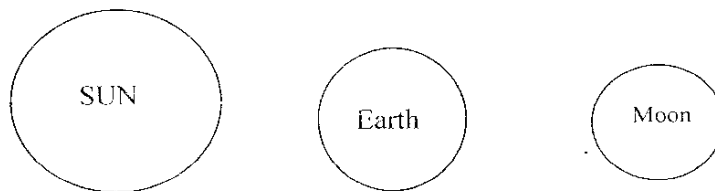

- 33a. **Cell B should have cell wall.**
 33b. **A: Cat C: Onion**
- 34a. **A banana has no seed and is edible.**
 34b. **X: Apple Y: Angsana**
 34c. **Fruit Y has wing-like structure.**

- 35 (1) **T**
 (2) **F**
 (3) **F**
 (4) **T**

- 36a. **African Violet has been grouped wrongly. The correct grouping for the plant is Group Z.**
 36b. **They are grouped according to how they reproduce.**

- 37a. The plant is bryophyllum.
 37b. The leaves from this plant are thick.
- 38a. A and C produce cells that will join together to develop into a baby.
 38b i) To carry out the waste produce by the developing baby
 38b ii) To give the developing baby nutrients those were eaten by the mother.
- 39a. The process is fertilization.
 39b. The remaining sperms will eventually die.
- 40a i) To convert light energy from the sun.
 40a ii) To make energy available for the organism.
 40b i) Sunlight
 40b ii) Oxygen
- 41a. B,D,C,A
 41b. The two end products of the process are sugar and starch.
- 42a. Grass
 42b. From the sun.
 42c. Leopards depend on grass, as the food source indirectly as when the rabbit eat the grass the energy is transferred to the rabbit and when the leopard eats the rabbit, the energy is transferred to the leopards.
- 43a. Step 1) Mix some yeast with some warm water and put the mixture in a test-tube.
 Step 2) Stopper it with a rubber bung attached to a delivery tube into test-tube containing Liquid X.
 Step 3) Bubbles was produced in the yeast mixture.
 43b. Limewater.
 43c. Carbon dioxide.
- 44a. The porcelain cup was able to keep the coffee hot.
 44b. 90, 84
 44c. The plastic cup was able to keep the coffee hot.
- 45a. No, this is not a fair experiment. Jane and Roy were only conducting an investigation to see if the temperature of water affect how fast biscuits is soften but no the time they should changed the time.
 45b. The type of biscuit.
- 46a. Water cycle.
 46b. Heat energy.
 46c. Sun.