

TAO NAN SCHOOL

PRIMARY 5 SCIENCE END-OF-YEAR EXAMINATION – 2010

Name: _____ () Date : 1 November 2010

Class: P5 _____

Time: 8.00a.m. to 9.45 a.m.

Booklet A

INSTRUCTIONS TO CANDIDATES

Do not open this booklet until you are told to do so.

Follow all instructions carefully.

Answer all questions.

	Score	Marks
Section A		60
Section B		40
Total		100

Parent's signature: _____

Section A (30 x 2 marks)

For each question from 1 to 30, four options are given. One of them is the correct answer. Make your choice (1, 2, 3 or 4). Shade the correct oval (1, 2, 3 or 4) on the Optical Answer Sheet.

1 Study the flow chart below.

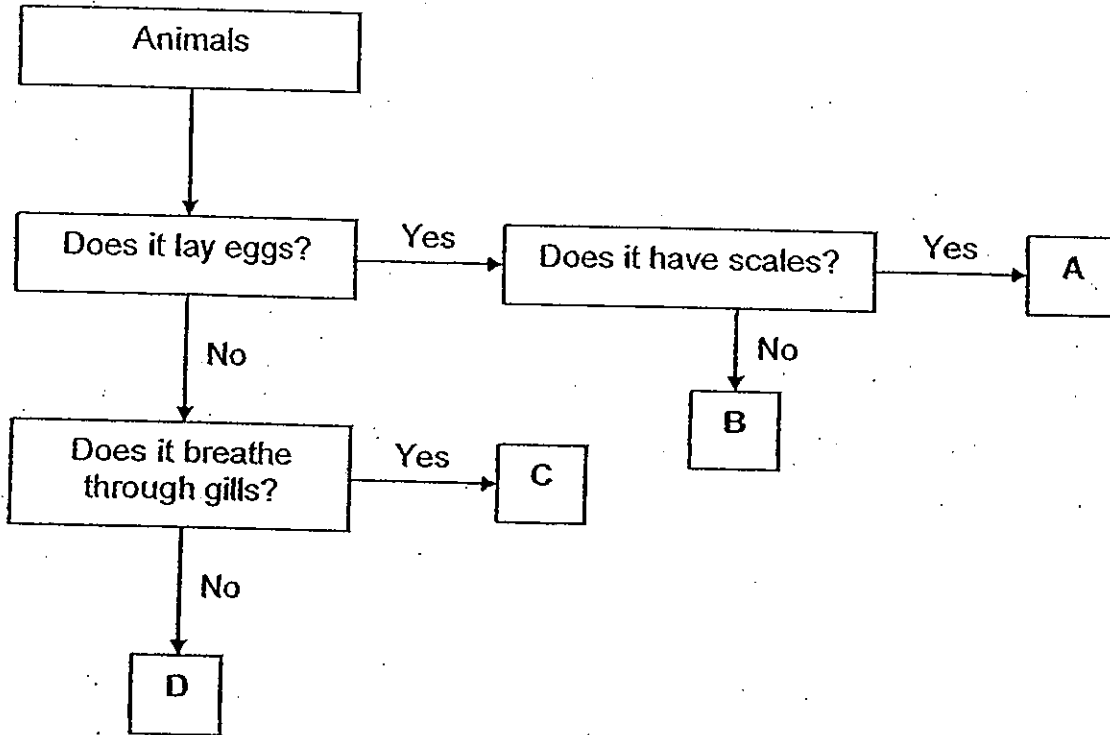

Which of the following are A, B, C and D?

	A	B	C	D
(1)	Snake	Penguin	Guppy	Monkey
(2)	Lizard	Platypus	Tortoise	Whale
(3)	Goldfish	Chicken	Whale	Tortoise
(4)	Crocodile	Pigeon	Camel	Polar bear

2 The life cycle of an animal is shown below.

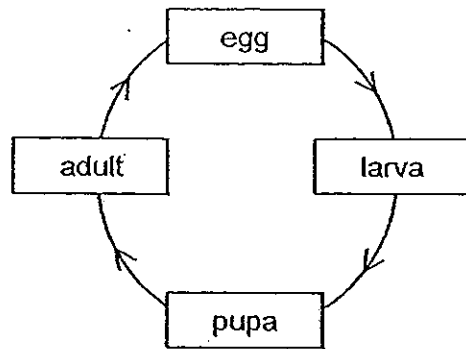

Which animals go through the life cycle above?

- (1) Butterfly and frog
- (2) Housefly and mosquito
- (3) Grasshopper and beetle
- (4) Cockroach and dragonfly

3 The classification chart of some objects is shown below.

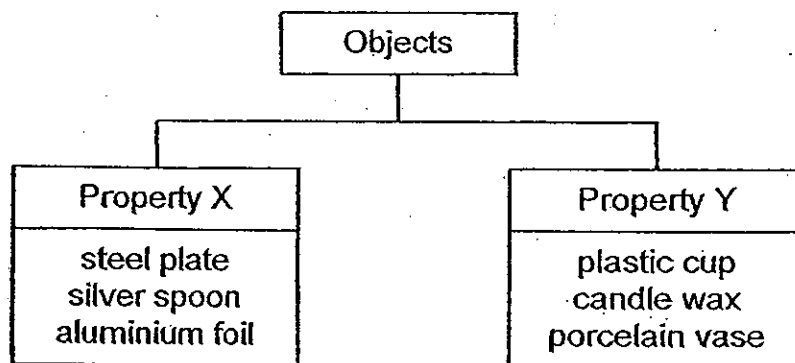

Which are Property X and Property Y?

	Property X	Property Y
(1)	flexible	non-flexible
(2)	non-magnetic	magnetic
(3)	electrical conductor	electrical insulator
(4)	allow light to pass through	do not allow light to pass through

4 Which of the following is correct?

- (1) The melting point of water is 100°C.
- (2) Steam condenses when it is heated.
- (3) Evaporation can take place in the dark.
- (4) Heat is not needed for evaporation to take place.

5 Joe observed the changes in temperature of a beaker of ice cubes and recorded his observations in a graph as shown below. The periods AB, BC, CD and DE show the heat changes that took place.

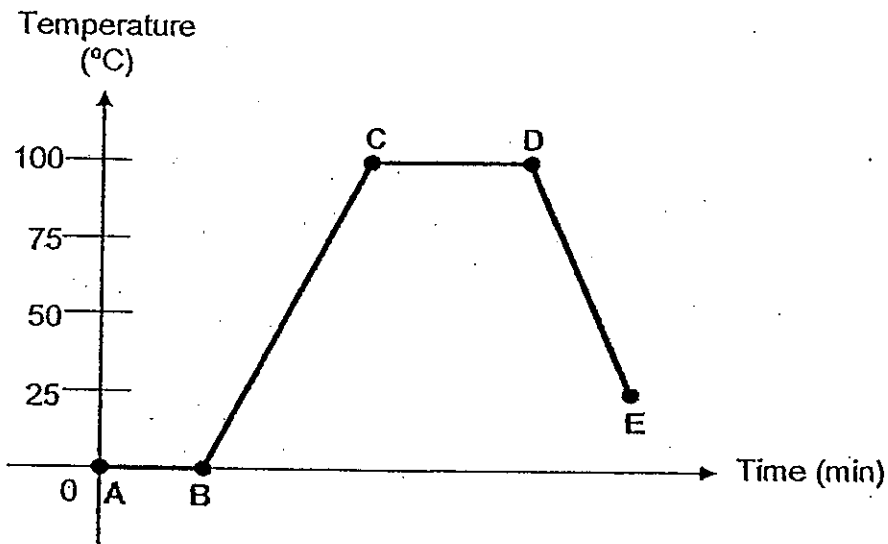

What are the heat changes that took place?

	AB	BC	CD	DE
(1)	heat gain	heat gain	heat gain	heat loss
(2)	heat loss	heat gain	heat gain	heat loss
(3)	heat gain	heat gain	heat loss	heat loss
(4)	heat loss	heat gain	heat loss	heat loss

- 6 Amy conducted an experiment as shown below. Each beaker contains the same amount of water at different temperatures. She then put five ice cubes in identical watch glasses over each beaker. She measured the time taken for the first water droplet to drip.

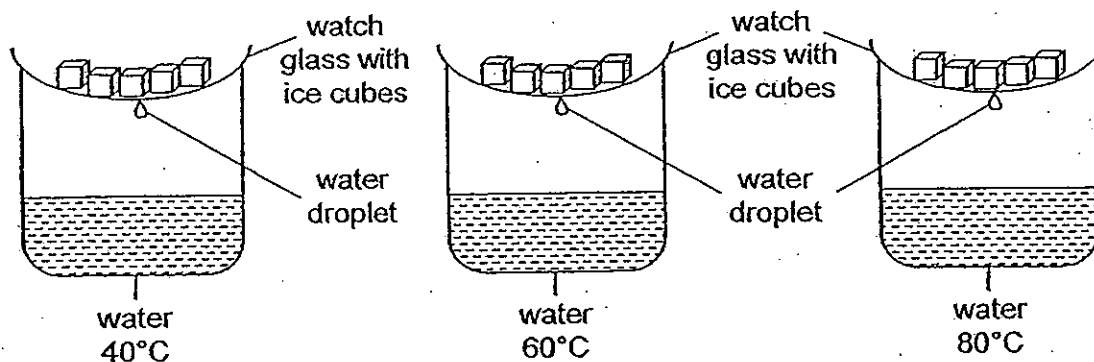

The table below shows the results of her experiment.

Temperature of water (°C)	Time taken for first water droplet to drip (s)
40	90
60	50
80	10

What is the aim of Amy's experiment?

- (1) To find out how the watch glass affects the number of water droplets formed.
- (2) To find out how the number of ice cubes affects the rate of condensation of water vapour.
- (3) To find out how the amount of water in the beaker affects the rate of evaporation of water.
- (4) To find out how the temperature of water in the beaker affects the time taken for first water droplet to drip.

7 A cup of hot water and a cup of cold water are covered and left on a table as shown in the diagram below.

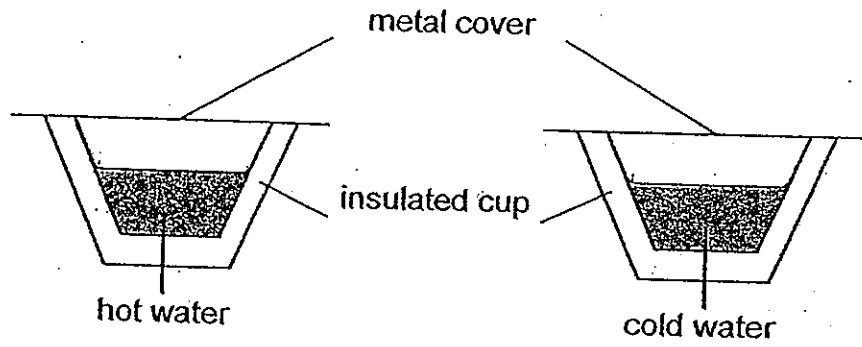

Which is the result after 5 minutes?

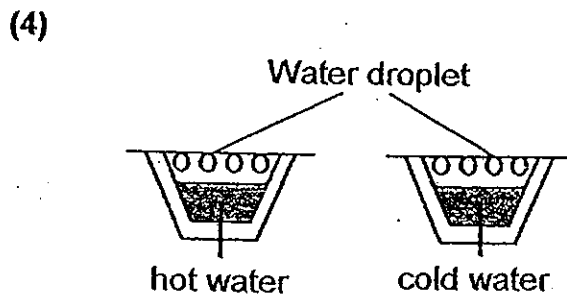
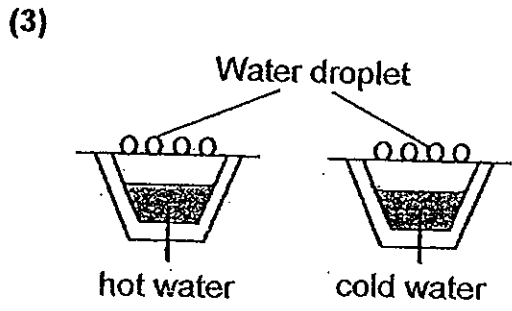
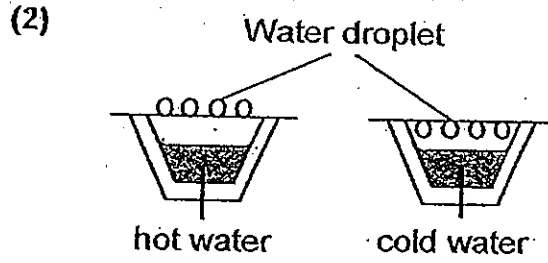
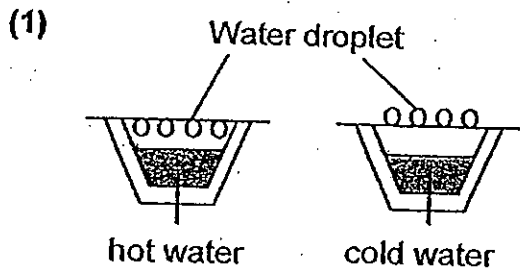

- 8 A and B represent the blood flowing in two different blood vessels of the human body. The arrows represent the direction of blood flow.

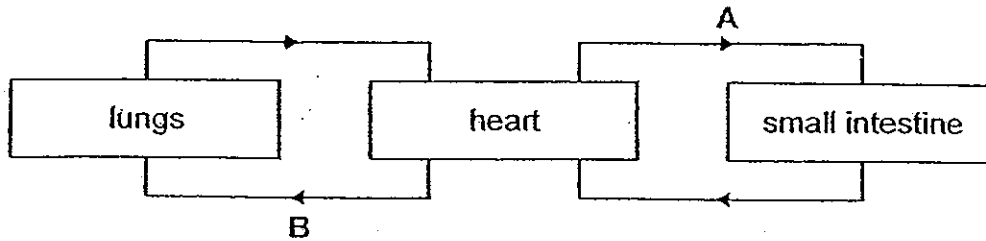

Which of the following is correct?

- (1) A is poorer in carbon dioxide and oxygen than B
 - (2) B is poorer in carbon dioxide and oxygen than A.
 - (3) A is richer in carbon dioxide but poorer in oxygen than B.
 - (4) B is richer in carbon dioxide but poorer in oxygen than A.
- 9 The classification chart below matches the parts of the human body to the body systems, A, B, C and D.

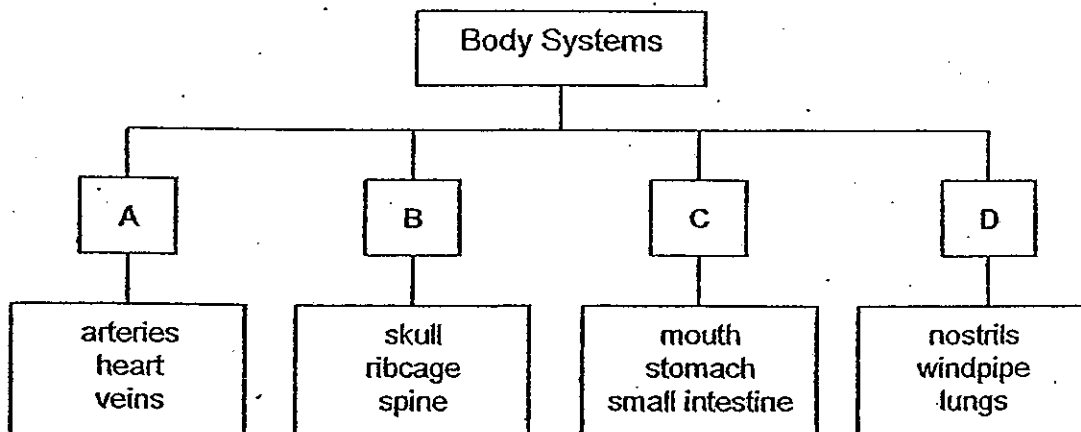

What are the body systems, A, B, C and D?

	A	B	C	D
(1)	Circulatory	Digestive	Skeletal	Respiratory
(2)	Respiratory	Skeletal	Digestive	Circulatory
(3)	Circulatory	Skeletal	Digestive	Respiratory
(4)	Respiratory	Digestive	Skeletal	Circulatory

- 10 Study the diagram of the digestive system below. In which part is digested food absorbed into the bloodstream?

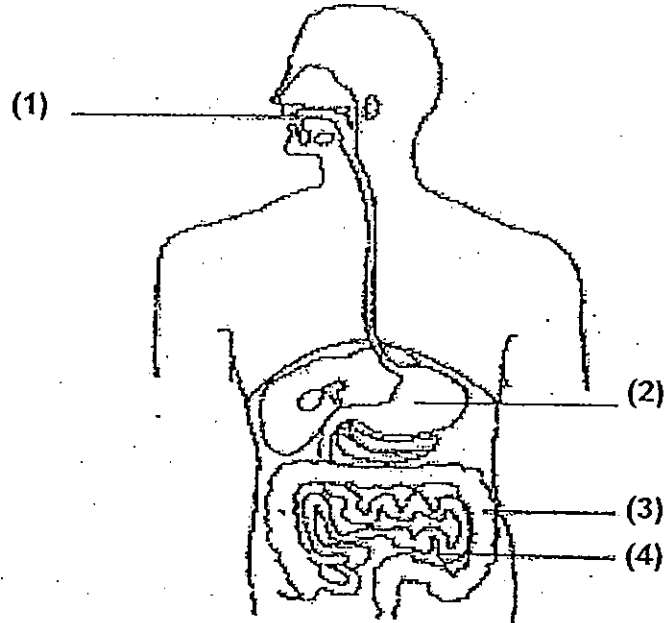

- 11 Which graph below represents the change in the rate of breathing of a healthy person before, during and after a morning jog of 20 minutes?

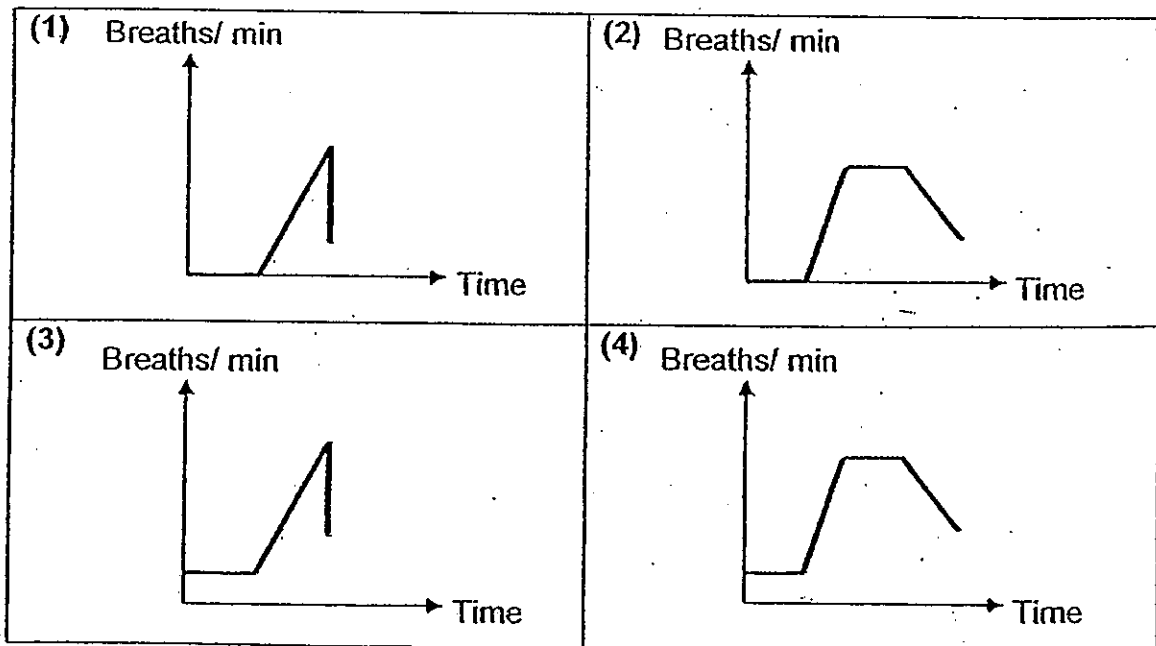

12 A substance has to pass through various parts of an onion skin cell before reaching the nucleus. Which of the following shows the correct order?

- (1) cell wall → cell membrane → cytoplasm
- (2) cell wall → cytoplasm → cell membrane
- (3) cytoplasm → cell membrane → cell wall
- (4) cell membrane → cytoplasm → cell wall

13 The table below provides some information on three cells, X, Y and Z. A tick (✓) indicates the presence of the part of a cell.

Cell structure	X	Y	Z
Nucleus	✓	✓	✓
Chloroplast		✓	
Cell wall	✓	✓	

What can you infer from the information provided in the table?

- (1) Cells, X, Y and Z, are unicellular organisms.
- (2) Cells, X and Z, are animal cells while Cell Y is a plant cell.
- (3) Cells, X and Z, can photosynthesize while Cell Y cannot photosynthesize.
- (4) Cells, X and Y, have a fixed shape while Cell Z does not have a fixed shape.

14 Mr. Ho conducted an experiment with identical flowers in his garden. He wanted to find out if a fruit can be formed when one part of each flower is removed before pollination.

- Flower A : The style is removed
- Flower B : The petals are removed
- Flower C : The anthers are removed

Then, he dusted pollen grains from the same type of flowers over the three flowers. Which flower(s) is/ are likely to produce fruits after a few weeks?

- (1) Flower B only
- (2) Flower A and Flower C only
- (3) Flower B and Flower C only
- (4) Flower A, Flower B and Flower C

- 15 Two types of plants, Plant A and Plant B, grew on an uninhabited island as shown below. The wind blew from the east for six months.

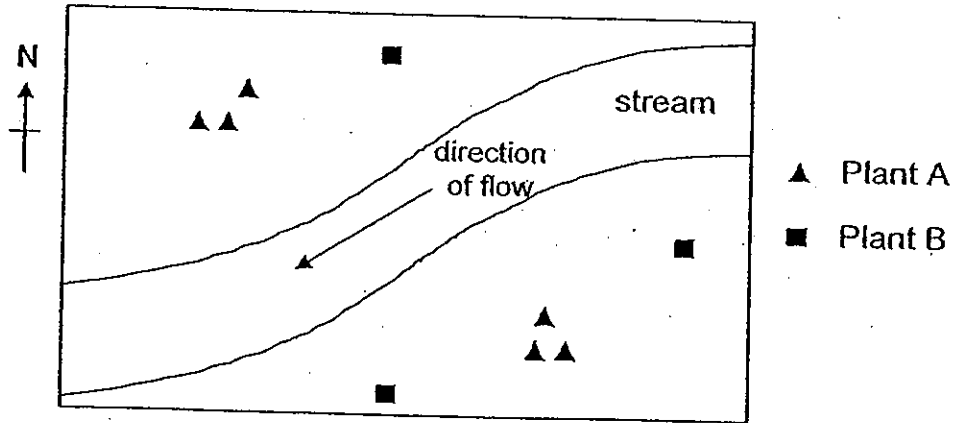

After six months, new plants started growing as shown below.

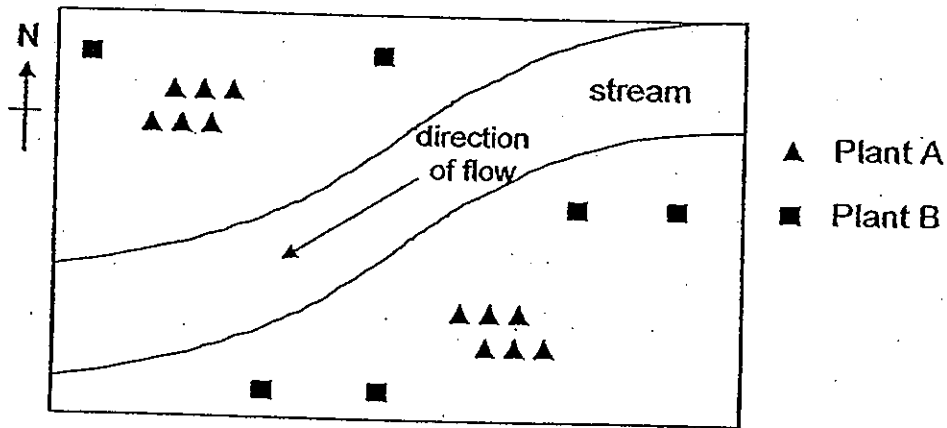

What are Plant A and Plant B?

	Plant A	Plant B
(1)	Papaya	Shorea
(2)	Rubber	Angsana
(3)	Love grass	African tulip
(4)	Flame of the Forest	Coconut

16 What are the characteristics of a wind-pollinated flower?

	Colour of petals	Scent of flower	Size and weight of pollen grains
(1)	Brightly coloured	Present	Small and light
(2)	Dull	Absent	Big and heavy
(3)	Brightly coloured	Present	Big and heavy
(4)	Dull	Absent	Small and light

17 The following set-ups were used by Gina to investigate the germination of beans.

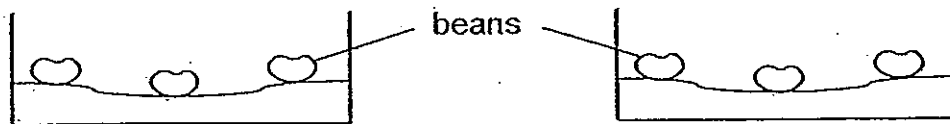

Set-up A
Temperature at 30°C
Moist Cotton Wool
Put in the dark

Set-up B
Temperature at 5°C
Dry Cotton Wool
Put in the light

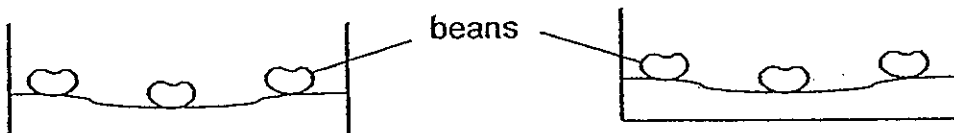

Set-up C
Temperature at 5°C
Moist Cotton Wool
Put in the dark

Set-up D
Temperature at 30°C
Dry Cotton Wool
Put in the light

Which two set-ups allow Gina to find out if warmth is needed for the beans to germinate?

- (1) Set-up A and Set-up B
- (2) Set-up A and Set-up C
- (3) Set-up B and Set-up D
- (4) Set-up C and Set-up D

- 18 Sharon set up an experiment as shown below and left it under the sun for a few hours.

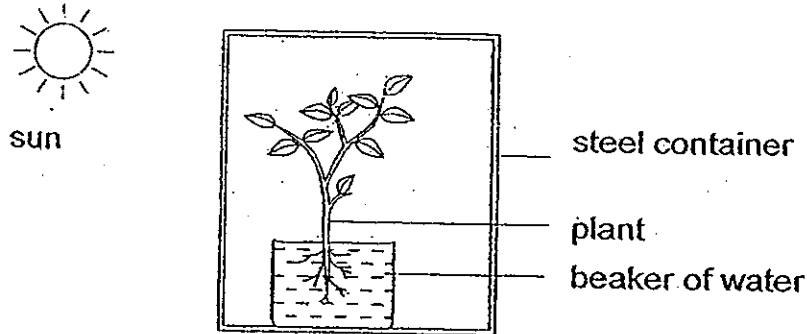

Which processes occurred inside the container?

- (1) Condensation and freezing
 - (2) Evaporation and respiration
 - (3) Photosynthesis and respiration
 - (4) Evaporation and photosynthesis
- 19 Peter set up an experiment as shown below.

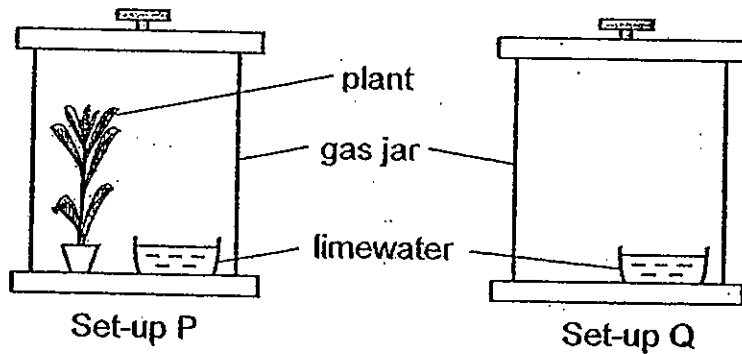

He then left the set-ups, P and Q, in a dark room for a day and recorded his observations in the table below.

Set-up	Limewater	
	At the beginning	After one day
P	clear	chalky
Q	clear	clear

What can Peter conclude from his experiment?

- (1) Plants need sunlight to photosynthesize.
- (2) Plants need limewater to photosynthesize.
- (3) Plants give out oxygen during photosynthesis.
- (4) Plants give out carbon dioxide during respiration.

- 20 The diagram below shows an electric circuit. If bulb A blows, how many bulbs will remain lit?

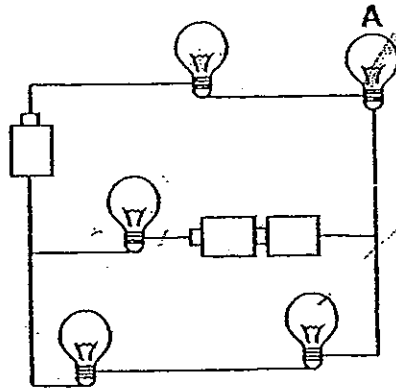

- (1) 1
- (2) 2
- (3) 3
- (4) 4

- 21 A circuit diagram is shown below.

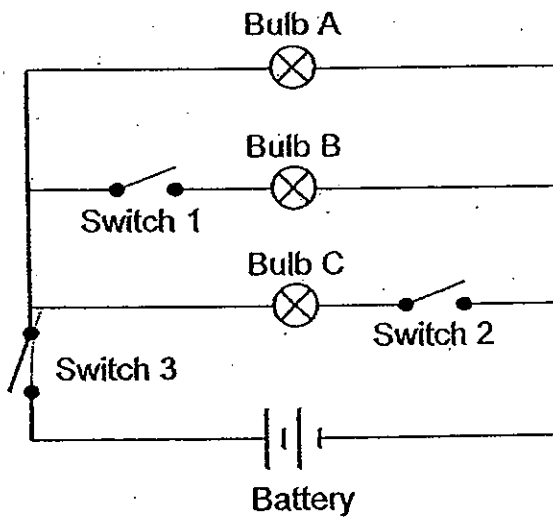

In which order must the switches be closed so that Bulb A lights up first, Bulb B lights up second and Bulb C lights up third?

	1 st switch to close	2 nd switch to close	3 rd switch to close
(1)	Switch 1	Switch 2	Switch 3
(2)	Switch 2	Switch 3	Switch 1
(3)	Switch 3	Switch 1	Switch 2
(4)	Switch 3	Switch 2	Switch 1

22 Study the electric circuit below. Which object(s) has/ have to be replaced with an iron rod to make only one of the bulbs light up?

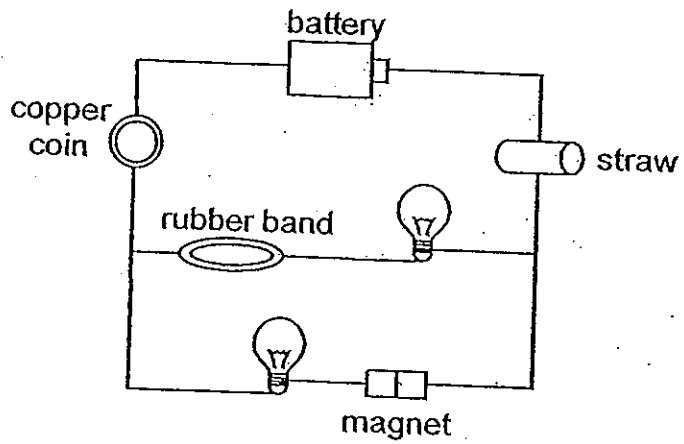

- (1) straw only
- (2) rubber band and straw only
- (3) magnet, straw and rubber band only
- (4) copper coin, rubber band and straw only

23 The iron rods and batteries used for each electro-magnet below are identical. Which electro-magnet will attract the most number of nails?

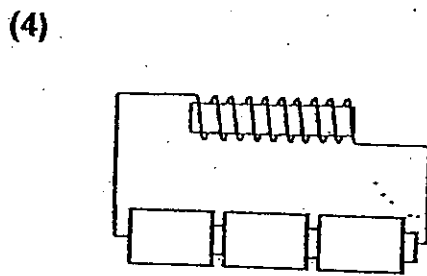
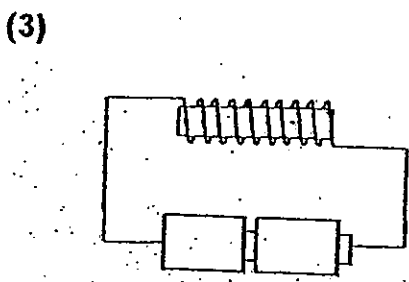
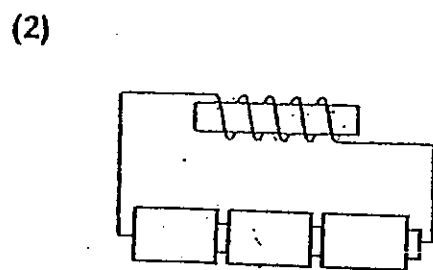
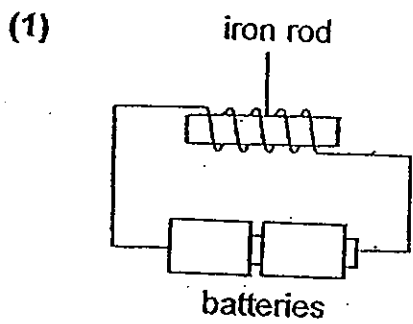

24 What is the process shown in the diagram below?

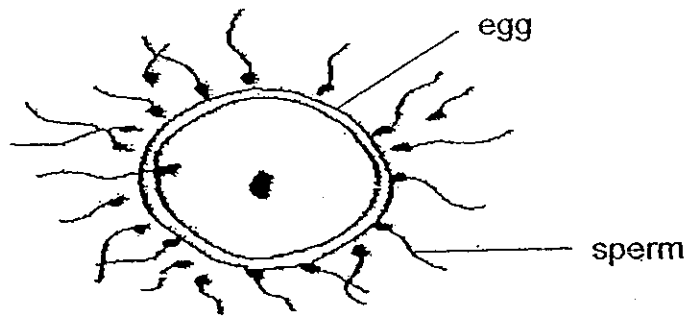

- (1) pollination
- (2) fertilisation
- (3) cell division
- (4) germination

25 Identify A, B and C of the female human reproductive system in the diagram below.

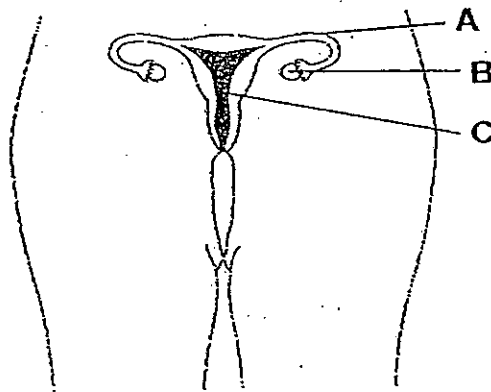

	A	B	C
(1)	oviduct	womb	ovary
(2)	womb	ovary	oviduct
(3)	oviduct	ovary	womb
(4)	ovary	womb	oviduct

26 Which of the following about sexual reproduction in humans is correct?

- (1) An ovum is smaller than a sperm.
- (2) An egg is produced by the uterus.
- (3) The fertilised egg develops in the stomach.
- (4) The egg will develop into a foetus after fertilisation.

27 A magnet is used in an experiment to test whether Metal X is a magnet.



The magnet was brought near Metal X. Which result shows that Metal X is definitely a magnet?

Key

→ Direction of movement
 ← movement

<p>(1)</p> <p>magnet Metal X</p>	<p>(2)</p> <p>magnet Metal X</p>
<p>(3)</p> <p>magnet Metal X</p>	<p>(4)</p> <p>magnet Metal X</p>

28 The table below shows the masses and volumes of solids A, B and C.

Solid	A	B	C
Mass (g)	100	50	50
Volume (cm ³)	10	20	20

Based on the table, which of the following is true?

- (1) 100 g of A has the same volume as 100 g of B.
- (2) 100 g of B has the same volume as 100 g of C.
- (3) 20cm³ of A has the same mass as 20cm³ of B.
- (4) 10cm³ of A has the same mass as 20cm³ of C.

29 The diagram shows the top view of a room. A, B, C, D, E, F, G, H, I and J are mirrors.

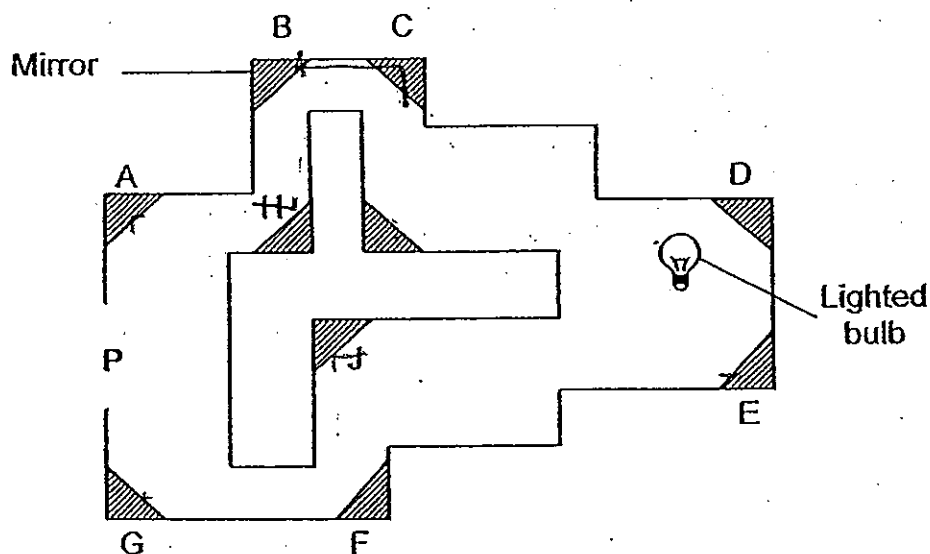

Pamela is standing at position P. What is the least number of mirrors she needs to see the lighted bulb?

- (1) 2
- (2) 4
- (3) 6
- (4) 8

30 Ali is standing in a room with a bright lamp. Which diagram shows the paths of light that enabled him to see the objects around him?

(1)

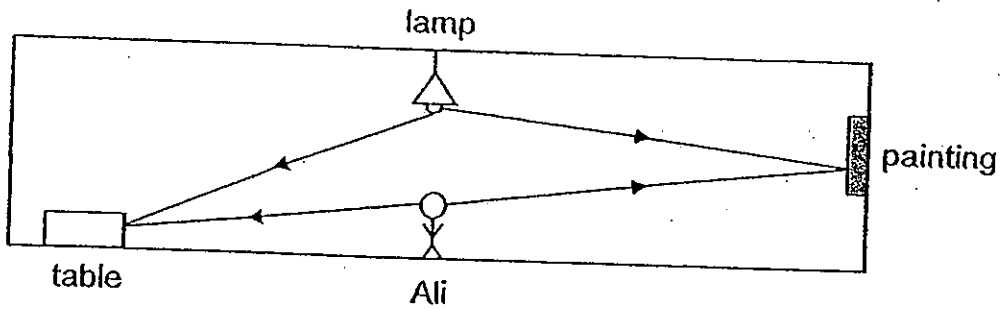

(2)

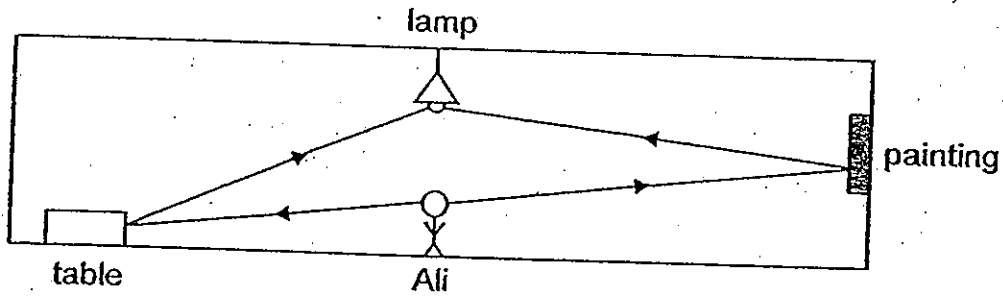

(3)

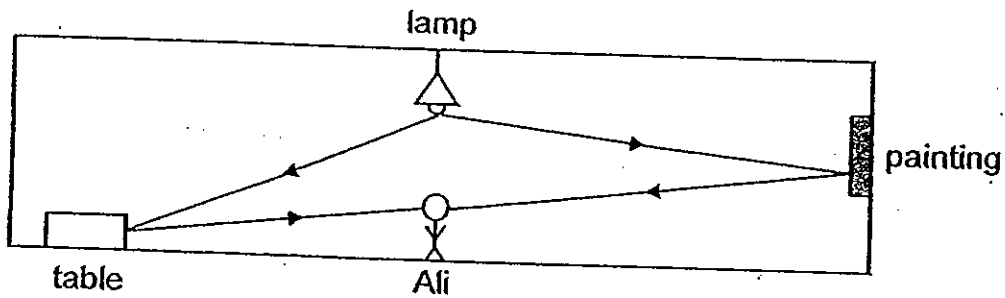

(4)

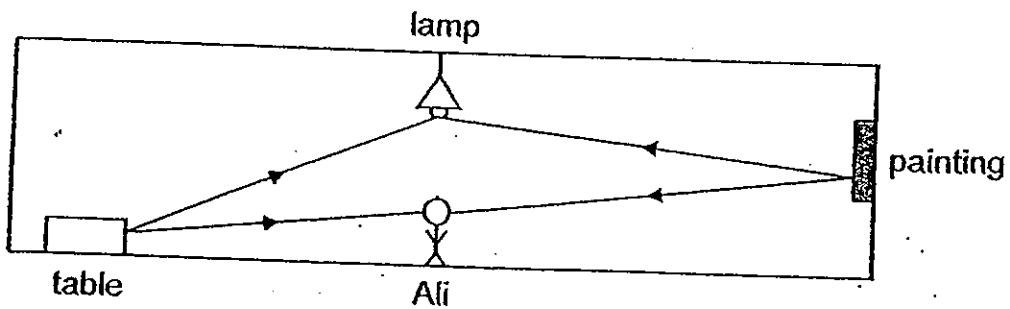

TAO NAN SCHOOL

PRIMARY 5 SCIENCE END-OF-YEAR EXAMINATION – 2010

Name: _____ ()

Date : 1 November 2010

Class: P5 _____

Time: 8.00a.m. to 9.45 a.m.

Booklet B

INSTRUCTIONS TO CANDIDATES

Do not open this booklet until you are told to do so.

Follow all instructions carefully.

Answer all questions.

	Score	Marks
Section B		40

Parent's signature: _____

Section B (40 marks)

For the questions, 31 to 44, write your answers in the spaces provided.

31 The classification chart below shows how water can be conserved.

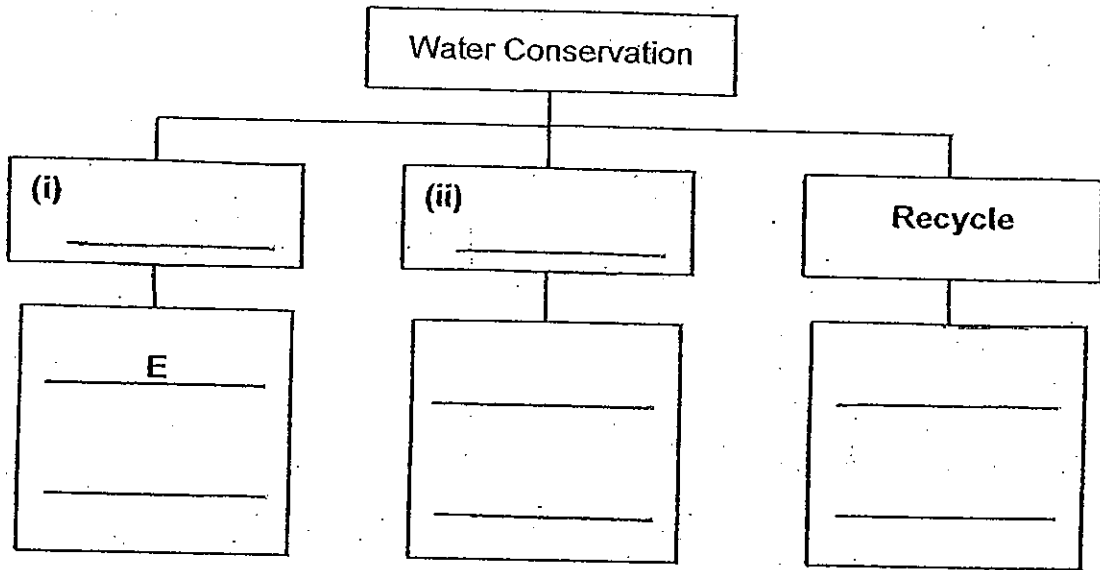

(a) Complete (i) and (ii) of the classification chart with suitable headings. [1]

(b) Classify the following actions represented by A, B, C, D and E in the classification chart to show how water is conserved. E has been done for you. [2]

	Action
A	Water the plants with water that had been used to wash the rice.
B	Treat waste water to make it suitable for human consumption.
C	Use water from washing clothes (last rinse) to wash the toilet.
D	Use a pail of water instead of a running hose to wash the car.
E	Take shorter showers.

- 32 Dan measured the rate of evaporation from three containers, A, B and C below. The amount of water in each container at the start of the experiment is the same.

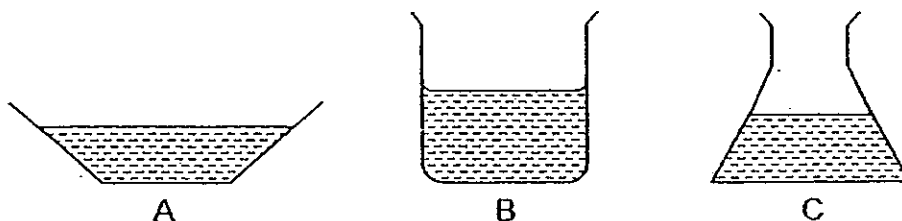

- (a) What is the aim of Dan's experiment? [1]

- (b) Name one **other** variable which he should keep constant in the experiment. [1]

33 The diagram below shows a system of the human body.

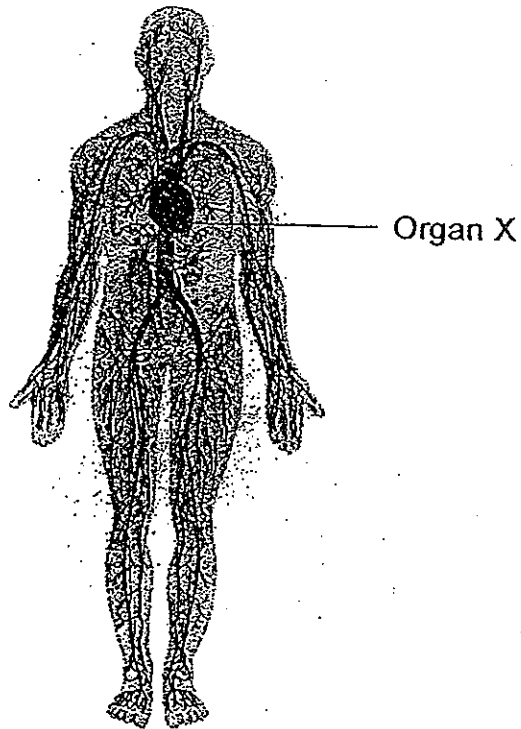

(a) What is Organ X? [1]

(b) What happens to Organ X when a person runs? [1]

(c) Which part of the skeletal system protects Organ X? [1]

34 Bala made a simplified model of the human respiratory system as shown below.

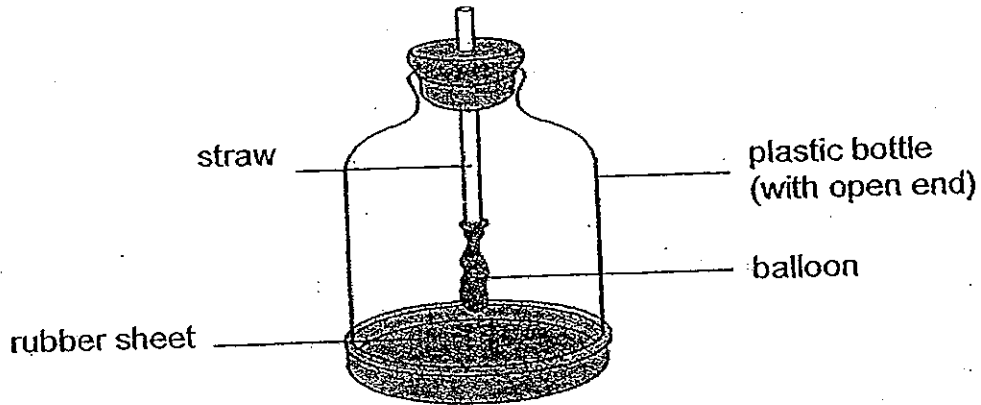

(a) Which parts of our respiratory system do the following parts of the model represent? [1]

Model	Respiratory System
balloon	
rubber sheet	

(b) What will you observe about the balloon when the rubber sheet is pulled downwards? [1]

(c) Bala's Science teacher said that his model could be improved. Suggest a way to improve Bala's model. [1]

35 The diagram below shows the cross-section of a flower.

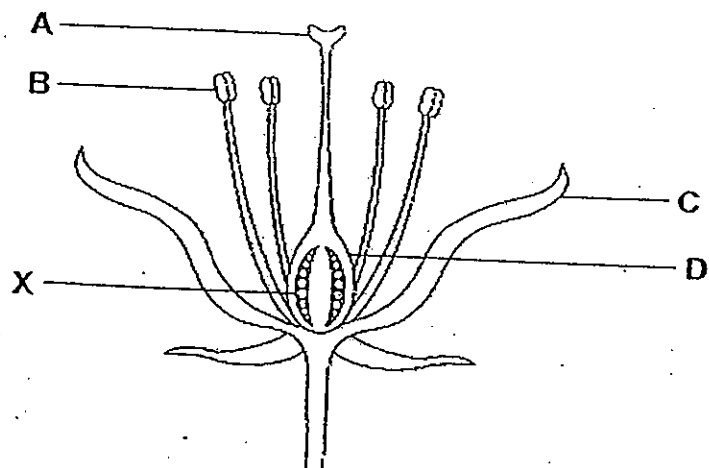

(a) The table below shows the functions of the different parts, A, B, C and D of the flower. Complete the table by matching the correct parts, A, B, C and D, next to each function. [2]

Function	Part of the flower
(i) Attracts insects	
(ii) Protects ovules	
(iii) Contains pollen grains	
(iv) Receives pollen grains	

(b) Which are the two processes that must take place for part "X" of the flower to develop into a seed? [1]

36

Jane wants to investigate if the growth of seedlings is affected by a certain condition. She placed two identical containers in a warm room and planted some seeds in them as shown in the diagram below.

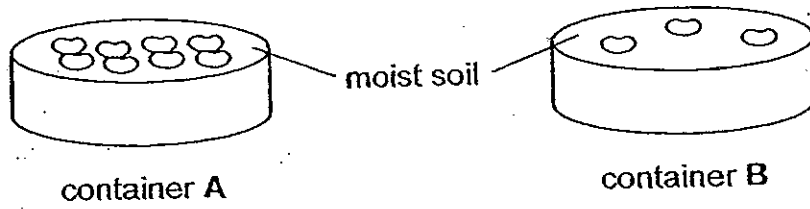

(a) What is the aim of Jane's experiment? [1]

(b) After several days, in which container will the seedlings grow healthier? [1]

(c) Explain your answer in (b). [1]

- 37 A plant reproductive system is similar to a human reproductive system. Complete the table below to show the parts that are similar in function. [2]

Plant Reproductive System	Human Reproductive System
Ovary	
Ovum	
Anther	
Pollen grain	

- 38 The Venn diagram below can be used to classify similarities and differences between animal cells and plant cells.

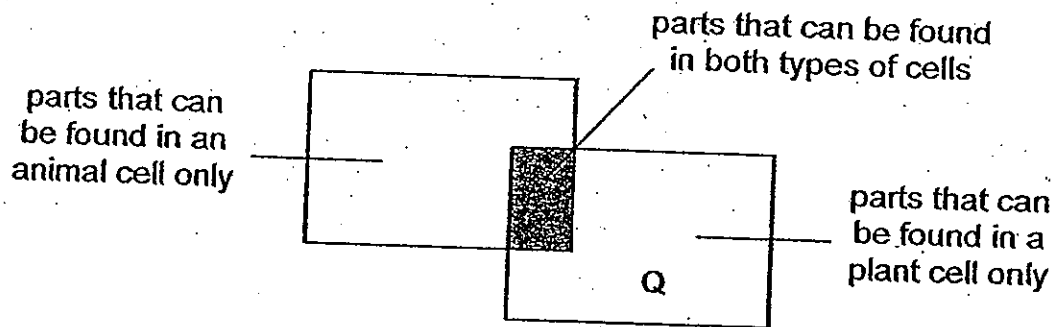

- (a) Name a part of a plant cell and an animal cell that can be found in the shaded area. [1]
-
- (b) Name one part of the plant cell that can be found at Q. [1]
-
- (c) State the function of the part of the plant cell in (b). [1]
-
-

39 Miss Tan gives two groups of pupils the following items.

Group A	Group B
<ul style="list-style-type: none">• 3 batteries• 2 bulbs• Some wires	<ul style="list-style-type: none">• 2 batteries• 2 bulbs• Some wires

She told each group to form a circuit using all of the given items. However, the bulbs in both groups must be equally bright. Draw two possible circuit diagrams formed by the two groups in the boxes below. [4]

Group	Circuit diagram
A	
B	

- 40 Tom used a circuit tester to test a circuit card as shown below.

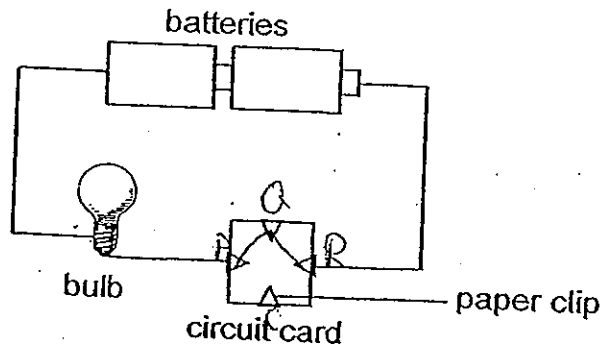

He connected different pairs of paper clips on the circuit card. The table below shows the results.

Paper clips connected to circuit tester	Does the bulb light up?
P and Q	Yes
Q and R	Yes
R and S	?
S and P	No
P and R	Yes
Q and S	No

- (a) Will the bulb light up when R and S are connected to the circuit tester? [1]

- (b) Based on the results given, draw lines on the circuit card below to show how the paper clips are connected. [2]

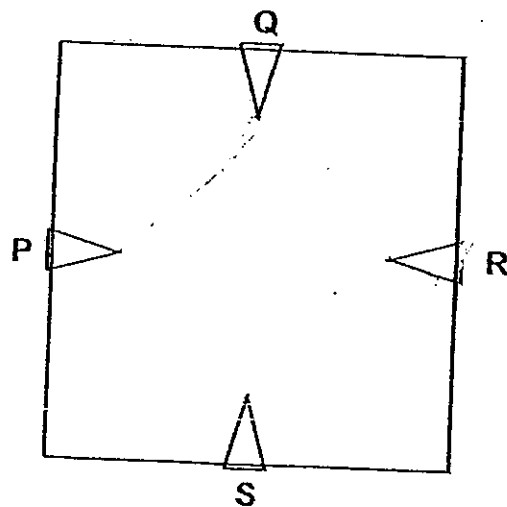

- 41 An experiment is set up as shown in the diagram below. The nichrome wire becomes hot and glows brightly when the switch is closed.

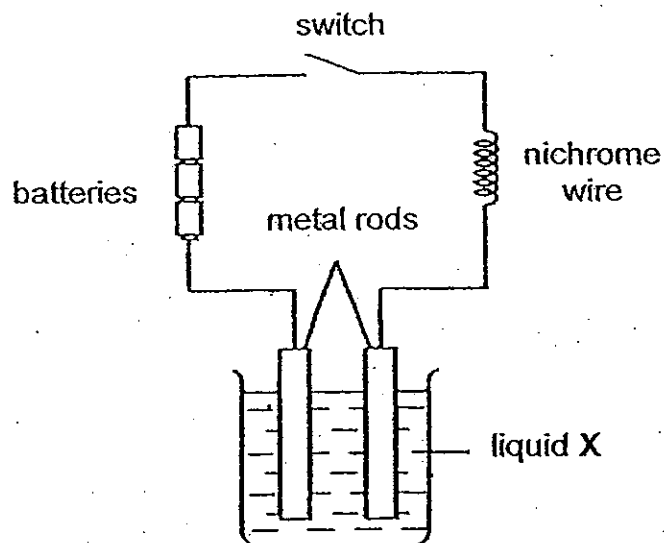

- (a) Based on the experiment, what can you conclude about liquid X? [1]

—
—

- (b) What would happen to the nichrome wire if the number of batteries is increased? [1]

—
—

- (c) Give a reason for your answer in (b). [1]

42 Write 'T' for True and 'F' for False for each of the following in the boxes provided. [2]

		T/F
(a)	Fertilisation can occur in the oviduct.	
(b)	A sperm can move by itself but an ovum cannot.	
(c)	Sexual reproduction only takes place in humans and flowering plants.	
(d)	The sperms that surround the egg but fail to fertilise it will eventually die.	

43 Study the diagram below. A, B, C and D are mirrors and X and Y are cars with drivers.

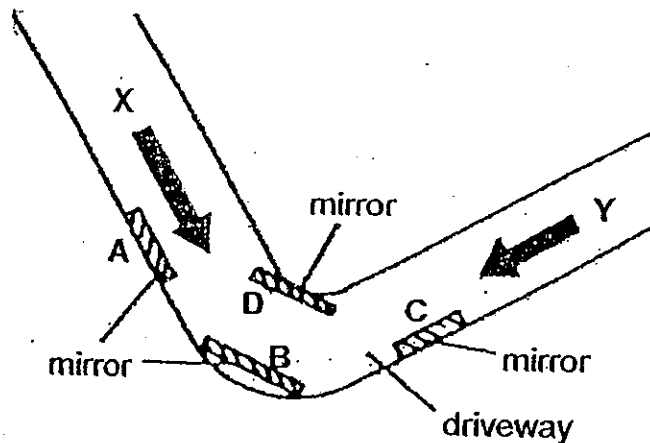

(a) Which mirror, A, B, C or D, enables the drivers at X and Y to see each other? [1]

(b) State two properties of light which enables the drivers at X and Y to see each other. [2]

44 Sam set up an experiment as shown below.

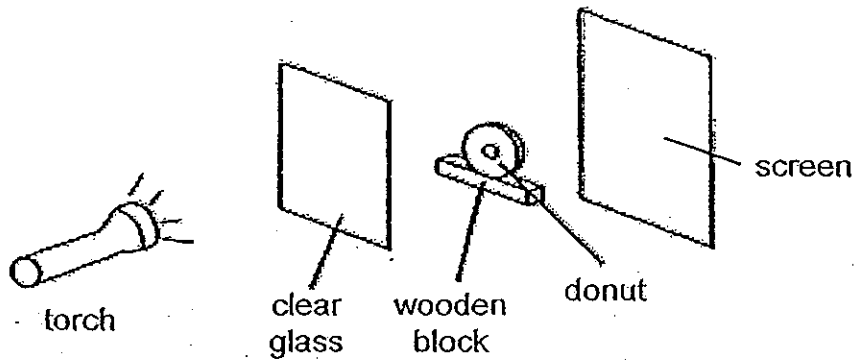

- (a) When the torch is switched on, a shadow is seen on the screen. Explain how the shadow is formed on the screen. [1]

- (b) In the box below, draw and shade the shadow formed on the screen. [1]

- (c) Without changing any of the items used, suggest how Sam can cast a larger shadow on the screen. [1]

THE END



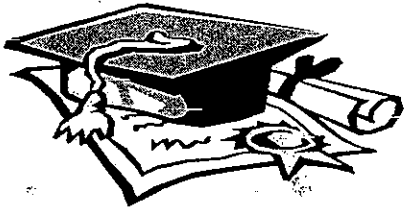

ANSWER SHEET

EXAM PAPER 2010

SCHOOL : TAO NAN PRIMARY
SUBJECT : PRIMARY 5 SCIENCE

TERM : SA2

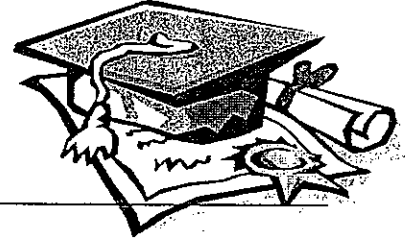

Q1	Q2	Q3	Q4	Q5	Q6	Q7	Q8	Q9	Q10	Q11	Q12	Q13	Q14	Q15	Q16	Q17
1	2	3	3	1	4	1	4	3	4	4	1	4	3	2	4	2

Q18	Q19	Q20	Q21	Q22	Q23	Q24	Q25	Q26	Q27	Q28	Q29	Q30
2	4	3	3	1	4	2	3	4	1	2	2	3

31ai) reduce

31aii) reuse

31bi) D

31bii) A , C

32a) It is to find out if the area of exposed surface affects the rate of evaporation.

32b) The temperature of the water.

33a) Organ X is the heart.

33b) Organ X beats faster

33c) The ribcage

34a) lung, diaphragm

34b) It inflates.

34c) He should use two balloons in the bottle and put in an inverted Y-shaped straw.

- 35ai) C
- 35aii) D
- 35aiii) B
- 35aiv) A

35b) The pollen grains must pollinate the stigma, go down the style and fertilize with part 'X'.

36a) It is to find out if the number of seeds affects the growth of the seedlings.

36b) Container B.

36c) There are less seedlings in Container B and it is not overcrowded unlike the seedlings in Container A which have to compete against each other for space, water, sunlight and nutrients.

- 37) Ovary – Ovary
- Ovum – Egg
- Anther – testes
- Pollen grain – sperm

38a) The nucleus

38b) The chloroplasts

38c) It contains chlorophyll that traps sunlight for photosynthesis.

39)

Group A

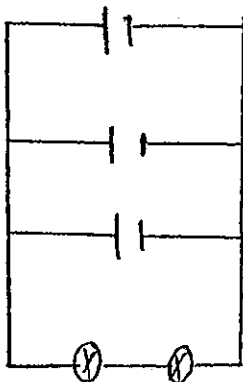

Group B

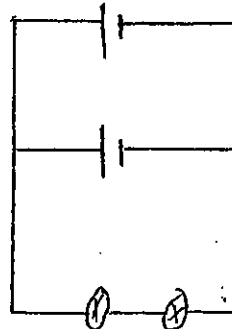

40a) No, it will not.

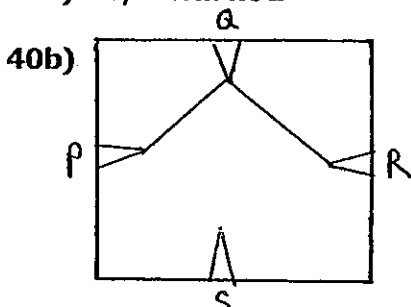

41a) Liquid X is a conductor of electricity.

41b) It would glow brightly and melt.

41c) The electrical current of the increased number of batteries will be too much for the nichrome wire and it will glow brightly before it melts.

42a) T

42b) T

42c) F

42d) T

43a) Mirror B

43b) Light travels in a straight line and it can be reflected.

44a) Clear glass is a transparent material and it allows all light to pass through but the wooden block and the doughnut are opaque materials and they cast a shadow on the screen.

44b)

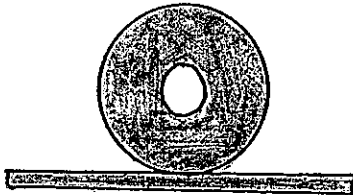

44c) He could move the wooden block and the doughnut closer to the torch.

