



RAFFLES GIRLS' PRIMARY SCHOOL

SEMESTRAL ASSESSMENT (2)
2017

Name : _____ Index No: _____ Class: P5 _____

Section A	50
Section B	40
Your score out of 90	90
Parent's signature	

30 Oct 2017

SCIENCE

Attn: 1 h 30 min

SECTION A (25 X 2 marks)

For each question from 1 to 25, four options are given. One of them is the correct answer. Make your choice (1, 2, 3 or 4). Shade the correct oval on the Optical Answer Sheet.

1. The diagram below shows the female reproductive system.

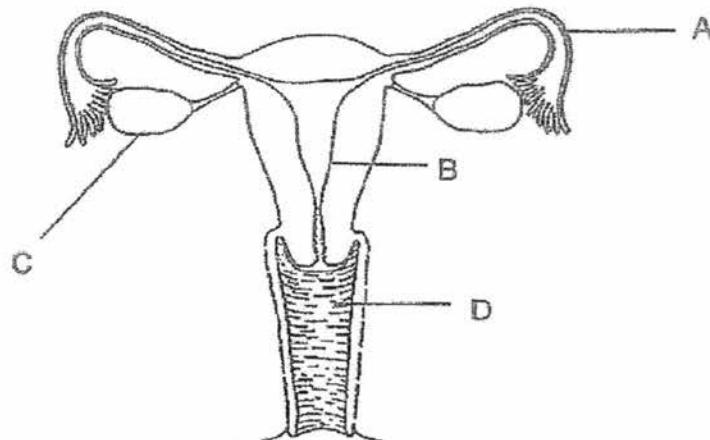

Which part of the female reproductive system does the development of the fertilised egg take place?

- (1) A
- (2) B
- (3) C
- (4) D

2. The chart below shows the process of fertilisation when A from Part X fuses with B from Part Y in human reproductive systems.

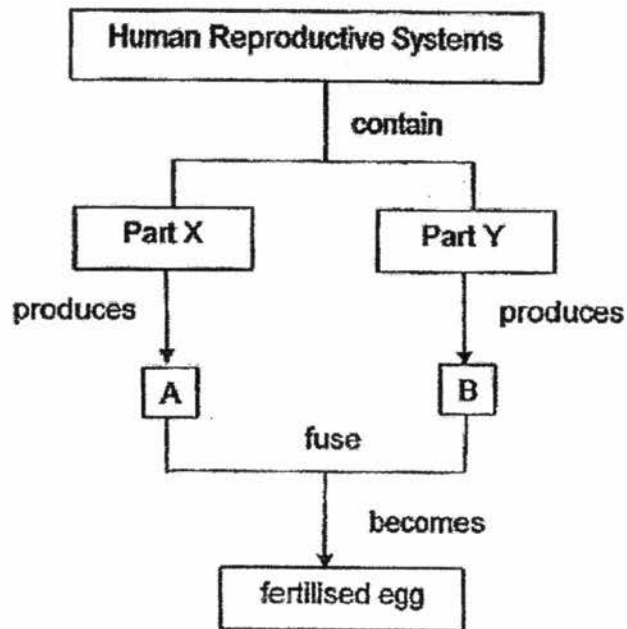

Which of the following shows correctly A, B, Parts X and Y?

	Part X	Part Y	A	B
(1)	womb	testis	egg	sperm
(2)	penis	womb	sperm	egg
(3)	ovary	testis	egg	sperm
(4)	testis	ovary	egg	sperm

3. Study the flow chart below.

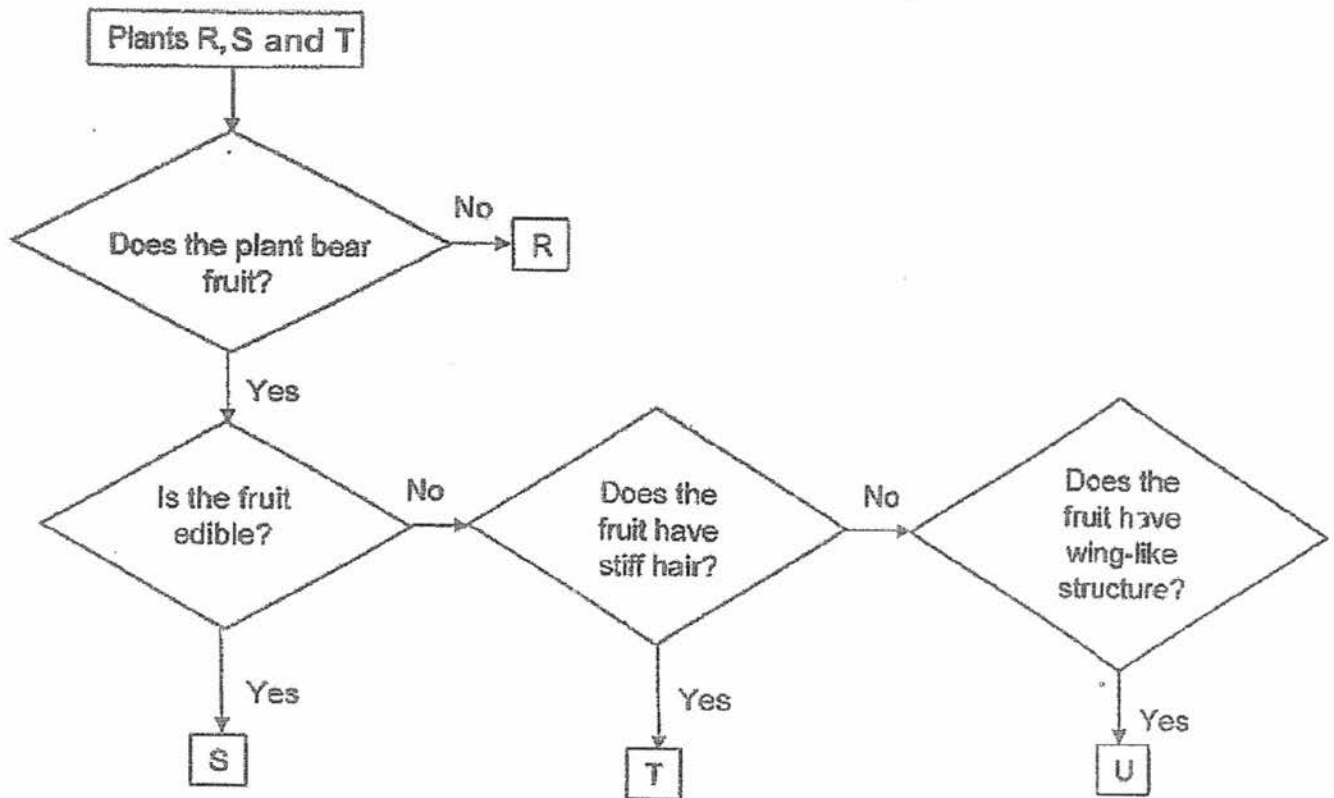

Based on the information above, which plant most likely disperses its fruit by animals?

- (1) R only
- (2) S only
- (3) S and T only
- (4) T and U only

4. Minah wanted to find out the effect of overcrowding on the growth of seeds. She used identical pots of size 30 cm^3 for her experiment.

Pot	Number of seeds	Type of seeds
A	12	X
B	8	Y
C	8	X
D	30	X
E	30	Y

Which of the following pots should Minah choose in order to ensure a fair test?

- (1) D and E only
- (2) A, B and D only
- (3) A, B and E only
- (4) A, C and D only

5. Theresa draw the diagram below to show how food and water are transported to and from different parts of the plant as represented by the letters P, Q and R.

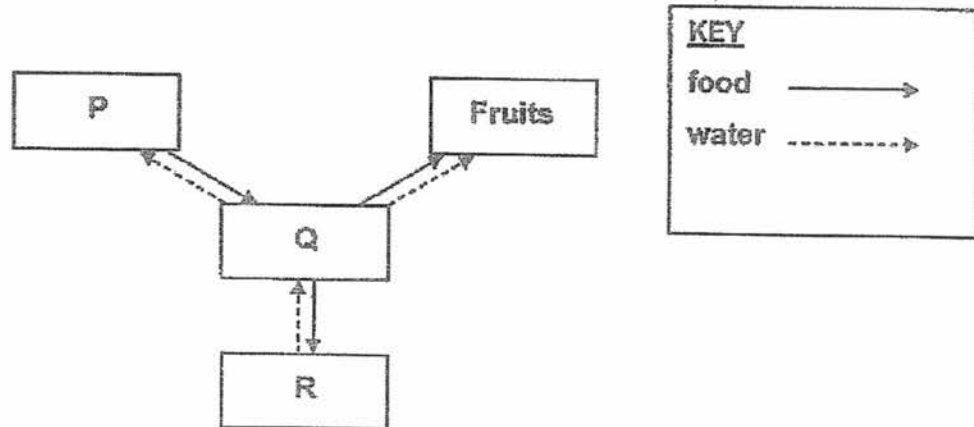

Based on the diagram, which of the following parts of the plant are represented by P, Q and R?

	P	Q	R
(1)	leaves	stem	roots
(2)	leaves	roots	stem
(3)	roots	leaves	stem
(4)	stem	roots	leaves

6. Study the diagrams below carefully.



System P



System Q

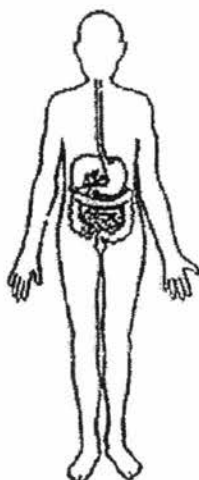

System R

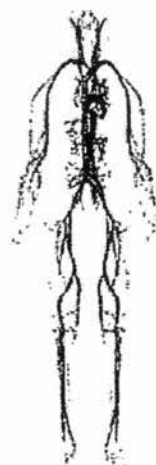

System S

Which of the following statements is/are correct?

- A Systems S and P protect our internal organs.
- B All systems need to work together in order for us to live.
- C Only System Q is required to allow movement to take place.
- D System S works with System R to transport digested food to all part of the body

- (1) A only
- (2) B and D only
- (3) A, B and C only
- (4) A, B, C and D

7. The diagram below shows the flow of blood in the human body.

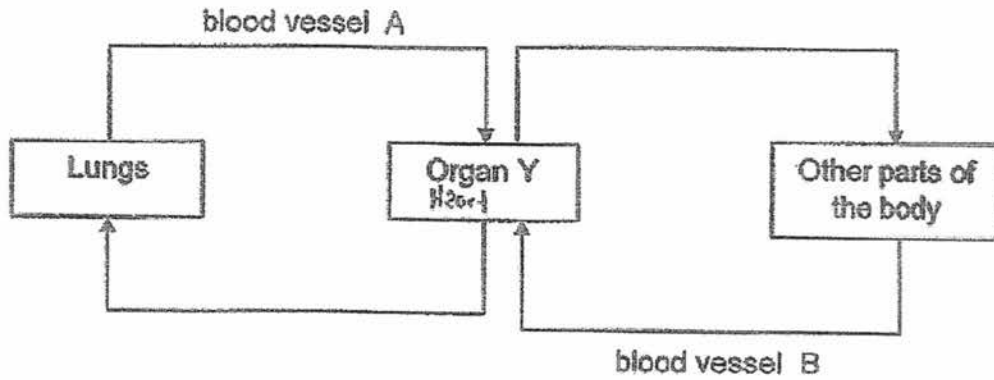

Which of the following is correct?

	Organ Y	Blood vessel A contains blood rich in	Blood vessel B contains blood rich in
(1)	heart	carbon dioxide	oxygen
(2)	heart	oxygen	carbon dioxide
(3)	brain	carbon dioxide	oxygen
(4)	brain	oxygen	carbon dioxide

8. The diagram below shows how sand is separated from water using a filter paper. The filter paper only allows some substances to pass through it.

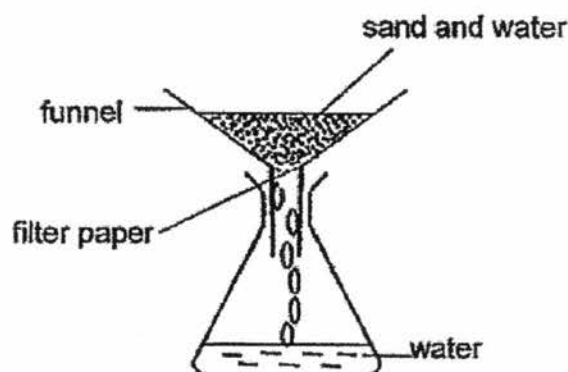

Which part of a cell has the same function as the filter paper?

- (1) nucleus
 - (2) cell wall
 - (3) cytoplasm
 - (4) cell membrane
9. The table below compares the plant transport system and human circulatory system. Identify the pair of information that is correct.

	Human Circulatory System	Plant Transport System
(1)	Transports blood rich in carbon dioxide to all parts of body.	Transports carbon dioxide to all parts of plant.
(2)	Transports blood containing digested food to all parts of body.	Transports food that is made by the leaves to all parts of plant.
(3)	Uses the heart to pump blood containing materials to all parts of body.	Uses the root and leaves to pump materials to all parts of the plant.
(4)	Has different tubes to transport blood containing digested food and water respectively to all parts of the body.	Has different tubes to transport food and water respectively to all parts of the plant.

10. The chart below shows how various gases and digested food are transported in the human body.

Key:
 —→ Path taken by digested food
 - - - -> Path taken by gases

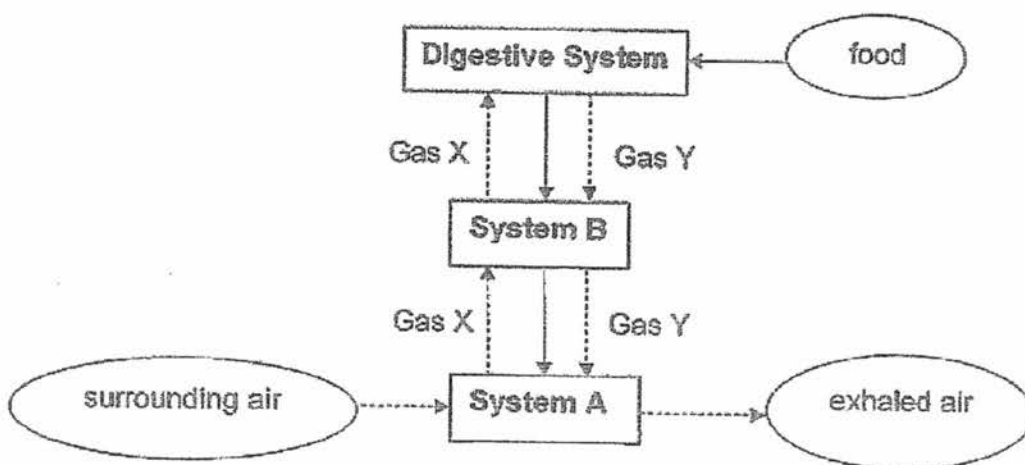

Which of the following correctly identify substances X and Y and systems A and B?

	Gas X	Gas Y	System A	System B
(1)	Oxygen	Carbon dioxide	Circulatory	Respiratory
(2)	Carbon dioxide	Oxygen	Circulatory	Respiratory
(3)	Carbon dioxide	Oxygen	Respiratory	Circulatory
(4)	Oxygen	Carbon dioxide	Respiratory	Circulatory

11. The flow chart below shows the function of each part of a plant.

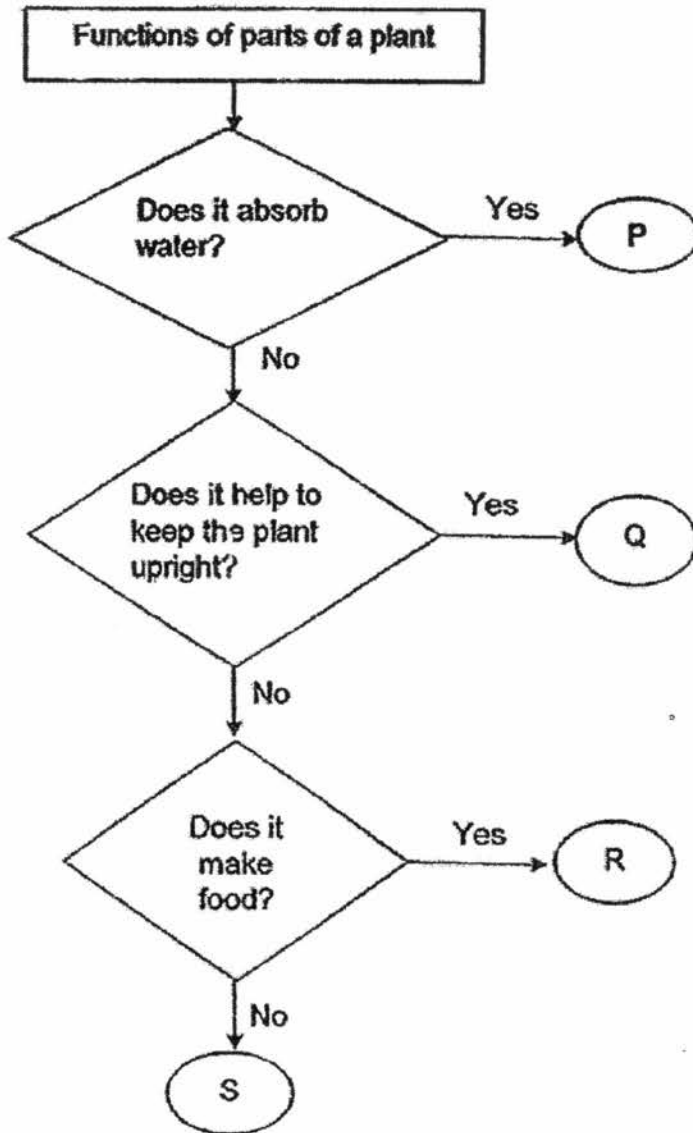

Based on the flowchart above, which of the following correctly identifies the different parts of the plant?

	P	Q	R	S
(1)	Flower	Leaf	Roots	Stem
(2)	Leaf	Flower	Stem	Roots
(3)	Roots	Stem	Leaf	Flower
(4)	Stem	Flower	Roots	Leaf

12. Anne placed an identical plant into each container of water as shown below.

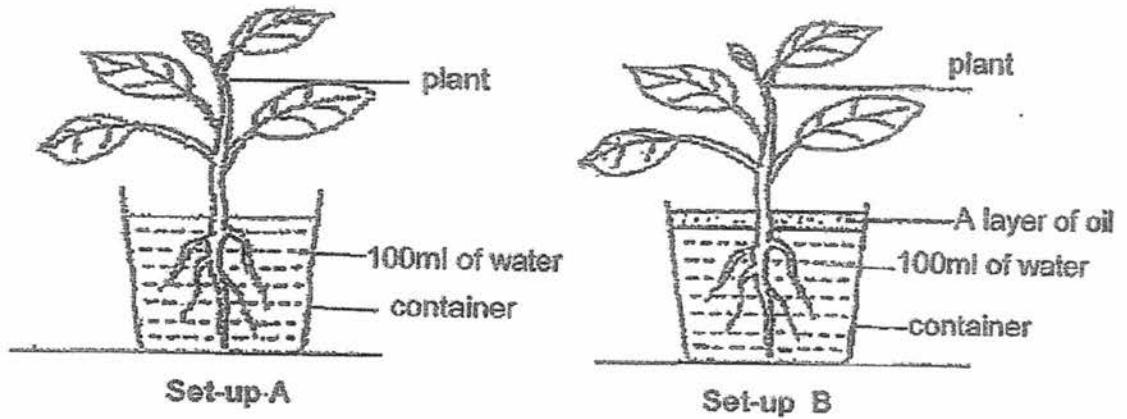

She recorded the volume of water in each container hourly for one week. The two set-ups were placed in the science lab. Which one of the following graphs shows the change of volume of water correctly?

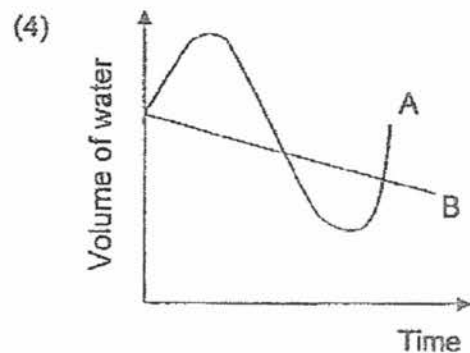
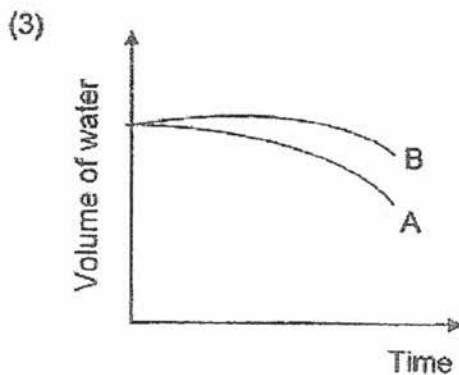
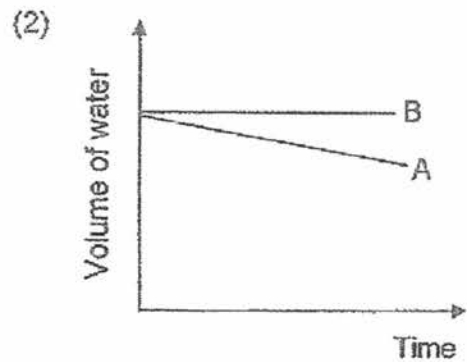
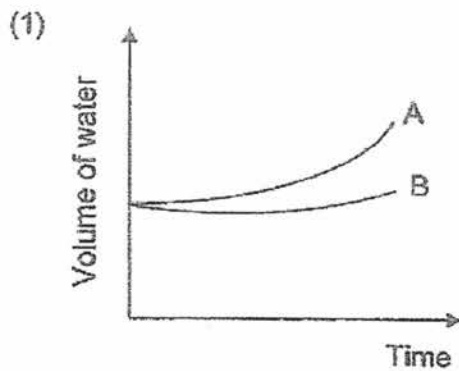

13. Sarah placed a cover over a container which contained some boiling water. The container was placed on the kitchen table.

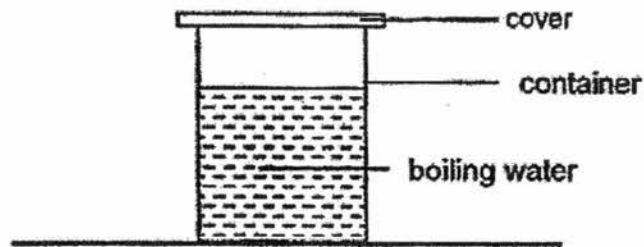

Beginning of experiment

After five minutes, Sarah observed formation of water droplets. Which of the following diagrams shows correctly where the water droplets would be observed?

- (1) (2) (3) (4)
- Diagram (1) shows a container with boiling water and a cover. Small circles representing water droplets are shown on the top surface of the cover. A label 'water droplets' points to these circles.
- Diagram (2) shows a container with boiling water and a cover. Small circles representing water droplets are shown on the inner surface of the cover and the inner surface of the container walls. A label 'water droplets' points to these circles.
- Diagram (3) shows a container with boiling water and a cover. Small circles representing water droplets are shown on the inner surface of the cover and the outer surface of the container walls. A label 'water droplets' points to these circles.
- Diagram (4) shows a container with boiling water and a cover. Small circles representing water droplets are shown on the outer surface of the cover and the outer surface of the container walls. A label 'water droplets' points to these circles.

14. The table below shows the melting points and boiling points of four different substances, P, Q, R and S.

Substance	Melting point (°C)	Boiling Point (°C)
P	80	220
Q	0	100
R	24	74
S	13	60

Which of these substances is/are gas(es) at 75 °C and liquid(s) at 50 °C?

- (1) P only
 - (2) S only
 - (3) P and R only
 - (4) R and S only
15. Kate set up the experiment below to investigate how the material of an object would affect the amount light passing through it.

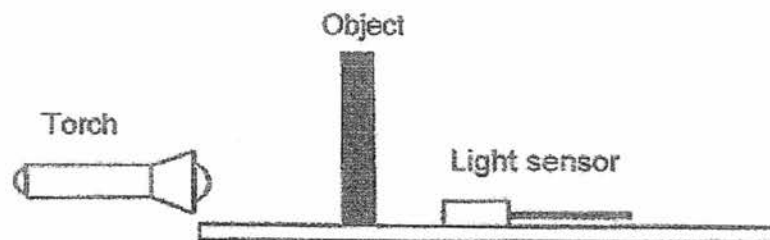

Which of the following variables should be kept constant to ensure a fair test?

- A The material of the objects.
 - B The thickness of the objects.
 - C The amount of light from the torch.
 - D The distance between the torch and the object.
- (1) A, B and C only
 - (2) A, B and D only
 - (3) B, C and D only
 - (4) A, B, C and D

16. Bob set up an experiment in a dark room using a torch and four sheets made of different materials, A, B, C and D. One of the sheet had a hole cut out from it.

The properties of the four materials are shown in the table below. A tick (✓) shows the presence of the property.

Materials	A	B	C	D
Allows most light to pass through			✓	✓
Does not allow light to pass through	✓	✓		

How should Bob arrange the sheets if he wanted a bright circular patch of light to appear on the sheet at Position 3 ?

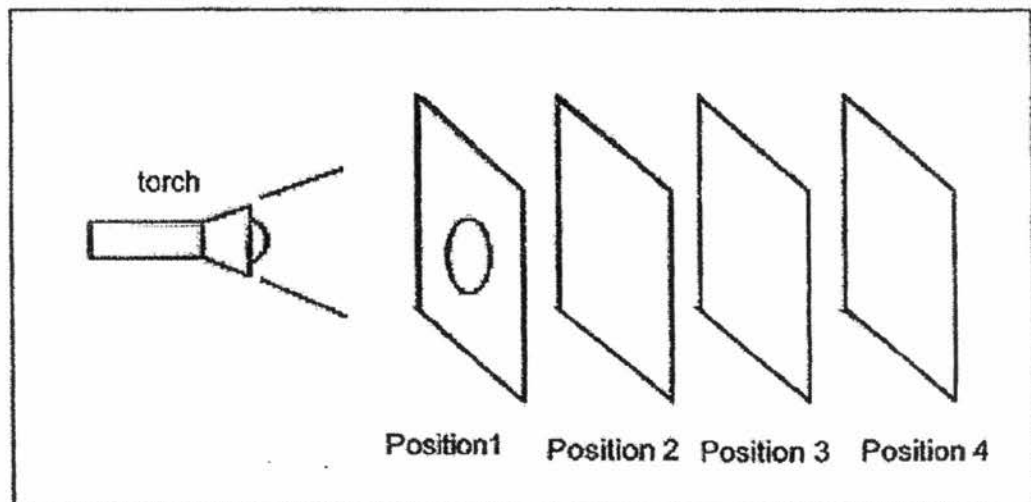

	Position 1	Position 2	Position 3	Position 4
(1)	A	B	D	C
(2)	A	C	D	B
(3)	B	D	C	A
(4)	B	C	A	D

17. Rina has three objects as shown below.

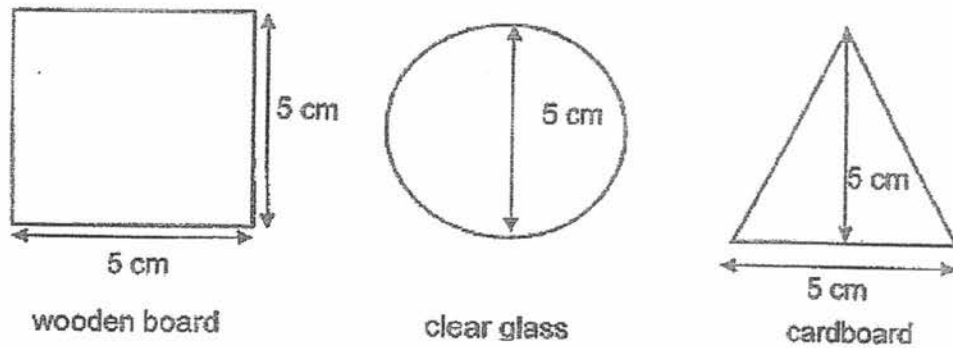

Then she glued the objects and prepared an experimental set-up as shown below.

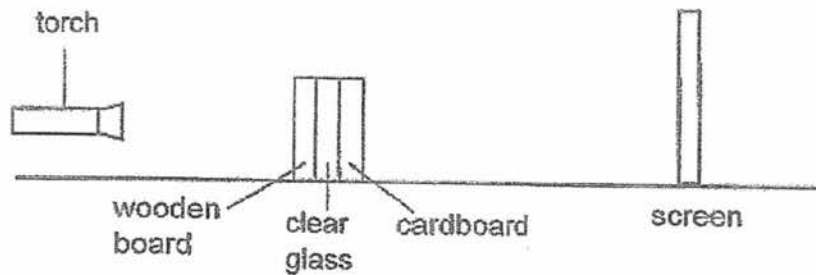

Which one of the following correctly shows the shadow formed on the screen?

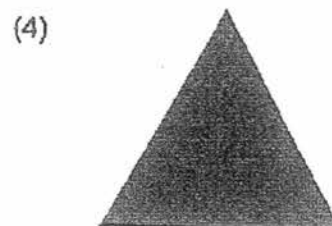
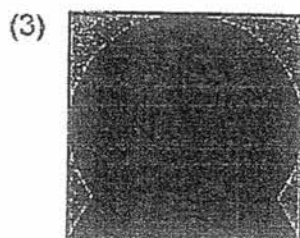
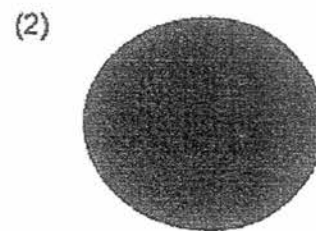
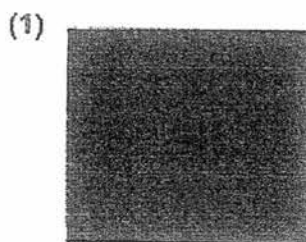

18. Justin placed a metal spoon in a cup of cold drink as shown in the diagram below.

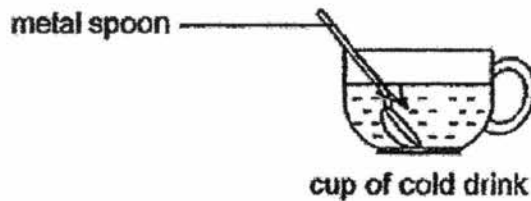

The spoon became colder after a while.

Which one of the following sentences correctly explains what happened?

- (1) The cup gains heat from the cold drink.
 - (2) The cold drink loses heat to the metal spoon.
 - (3) The metal spoon loses heat to the cold drink.
 - (4) The metal spoon gains heat from the cold drink.
19. Two beakers of water, A and B, were heated with the same amount of heat until the water boiled. The changes in the temperature of water for each beaker were recorded in the graph shown below.

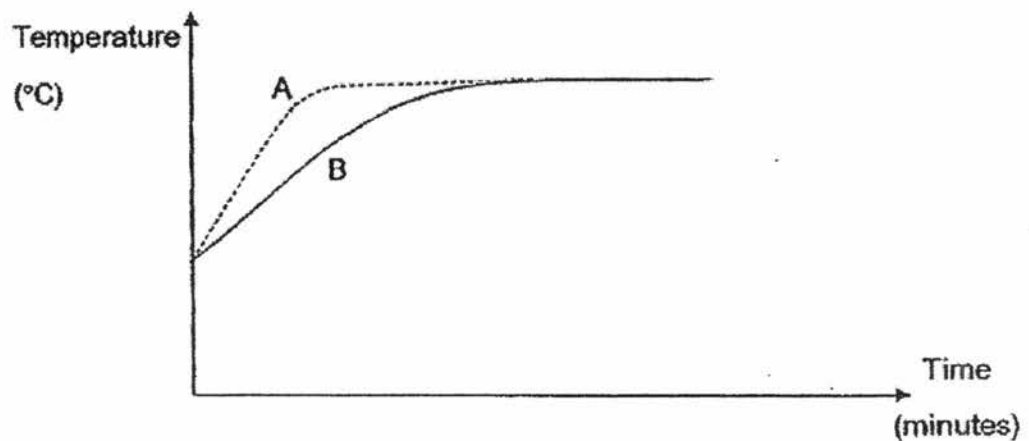

Which of the following best explains the graph above?

- (1) The water in beaker B was heated over a longer period.
- (2) The amount of water in beaker B was more than the amount in beaker A.
- (3) The water in beaker A had a higher boiling point than water in beaker B.
- (4) The water in beaker A was warmer than water in beaker B at the start of the experiment.

20. Ian wanted to find out if board A or B is a better conductor of heat. He placed a beaker of boiling water each on board A and B respectively.

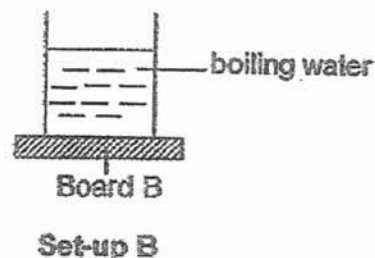
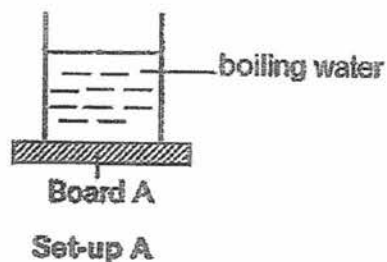

He recorded the change in temperature of water in each set-up and concluded that board A was the better heat conductor.

Which one of the following graphs best represents the result of Ian's experiment?

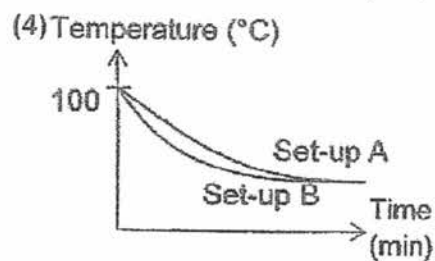
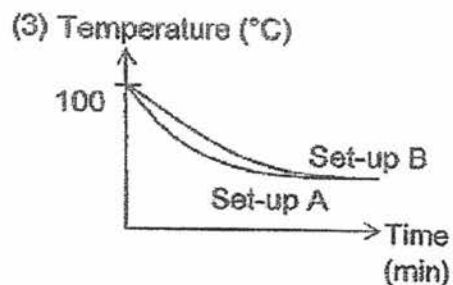
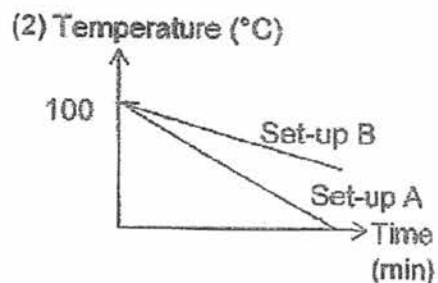
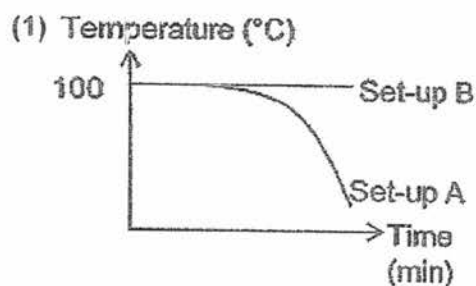

21. The diagrams below show four circuits.
In which one of the circuits will the bulb light up?

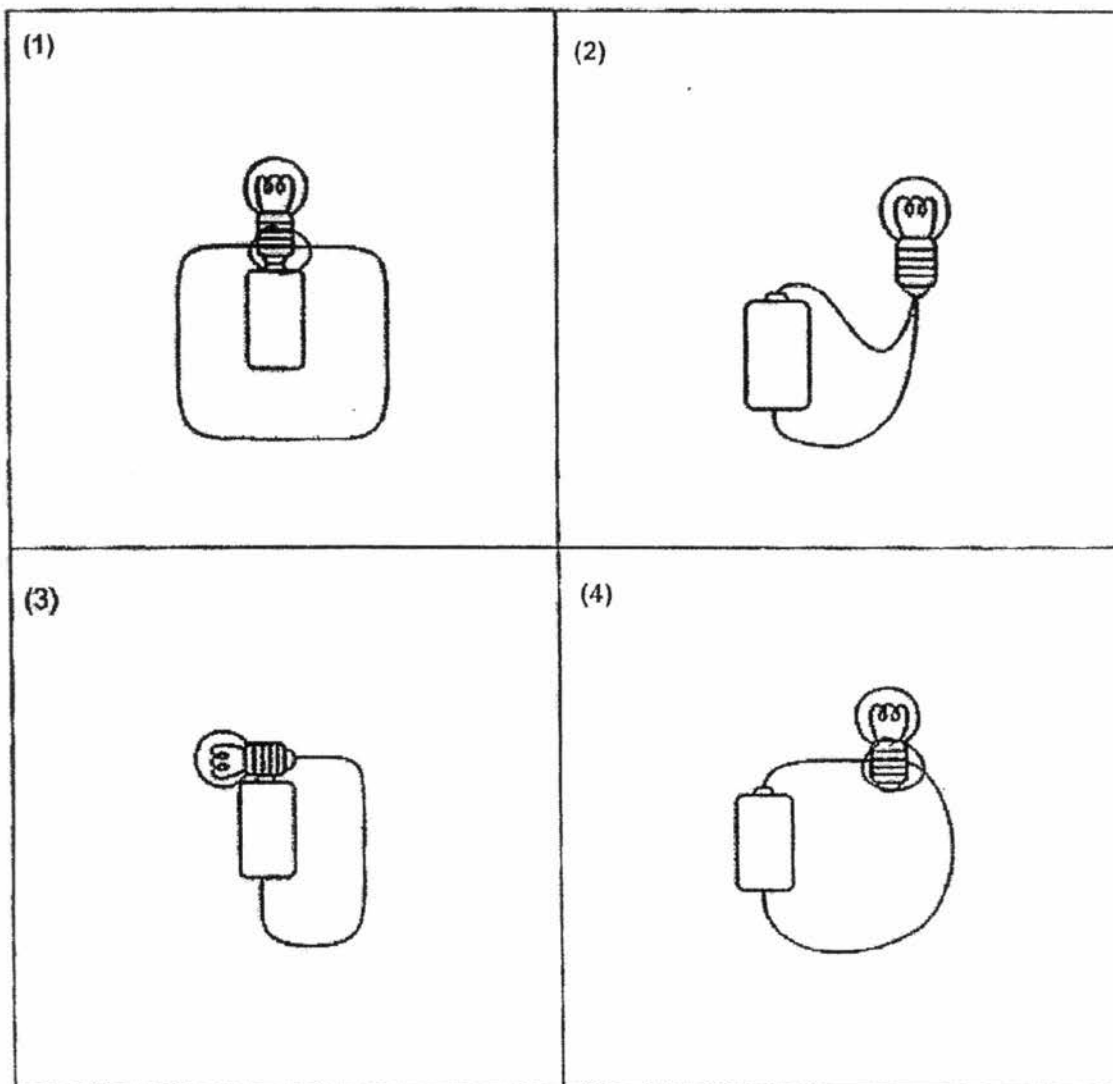

22. Marcus used a circuit tester to test a circuit card. He recorded the results in a table as shown below.

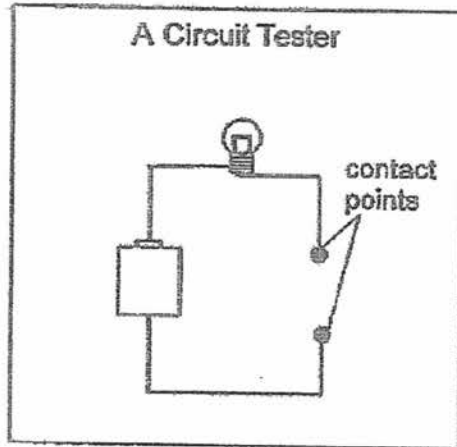

Clips tested	Does the bulb light up?
W and X	Yes
W and Y	Yes
W and Z	No
X and Y	Yes
X and Z	No
Y and Z	No

Which one of the following circuit cards shows correctly the way which the metal clips are connected by wires?

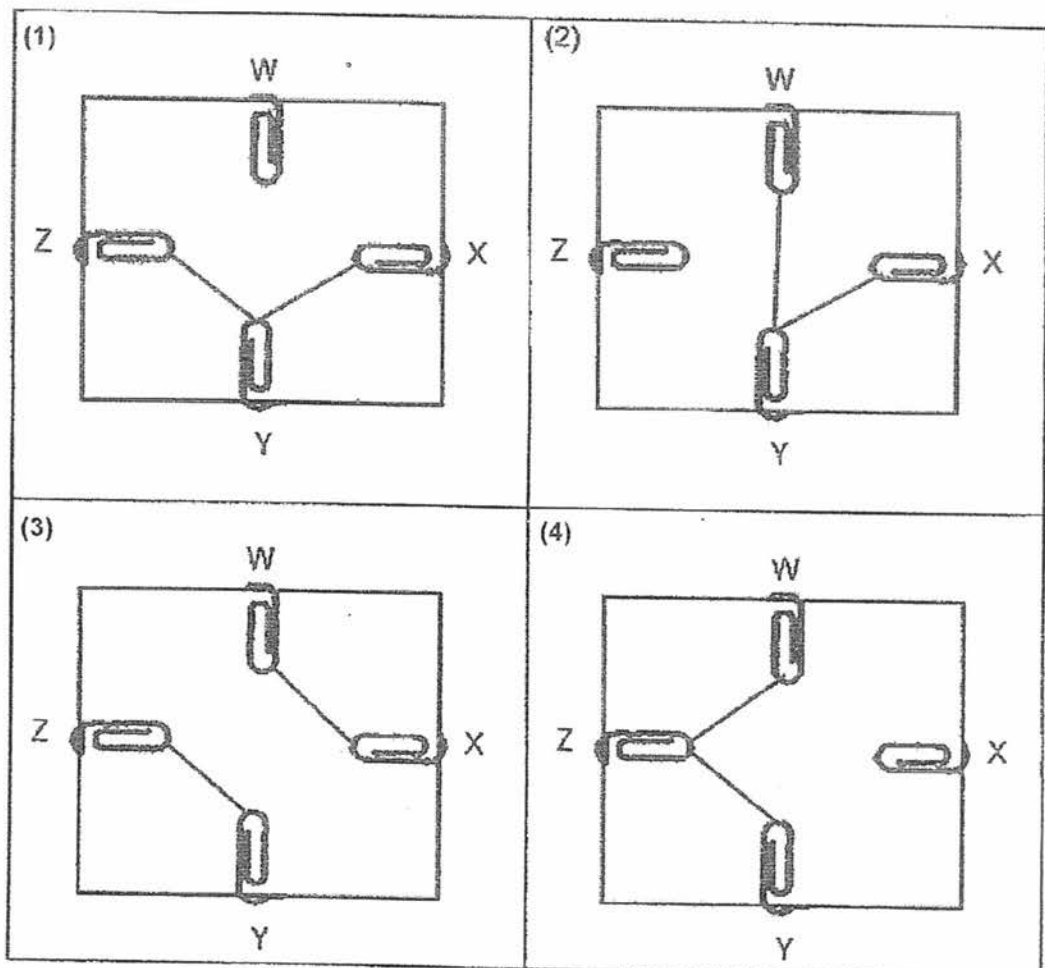

23. The diagrams below show four circuit diagrams, P, Q, R and S.

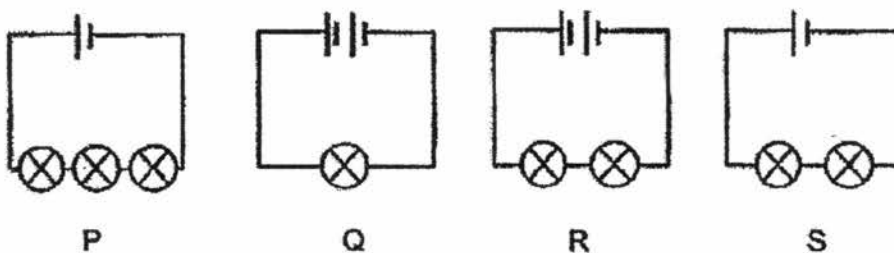

Which one of the following shows correctly the arrangement of the bulbs from the dimmest to the brightest?

- (1) P, S, R and Q
- (2) P, Q, R and S
- (3) Q, R, S and P
- (4) S, P, R and Q

24. Larry used three magnets, AB, CD, EF, and attached them to the ceiling at equal distance from one another as shown below.
The diagram below shows the interactions between the three magnets.

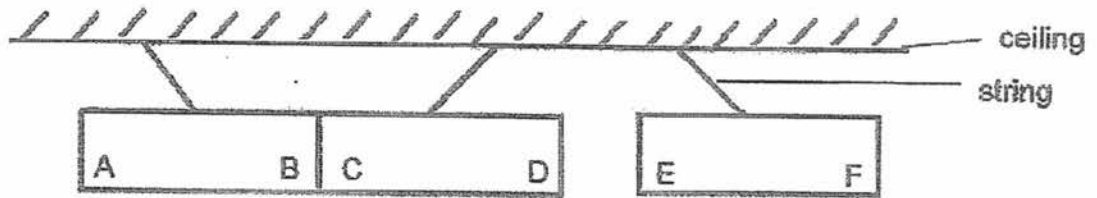

Which one of the following arrangements is possible?

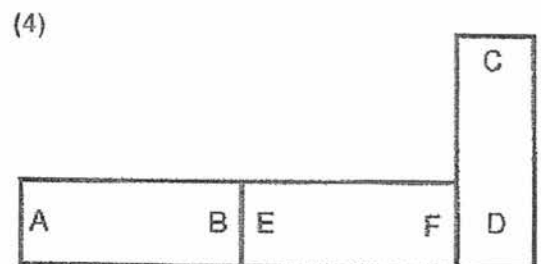
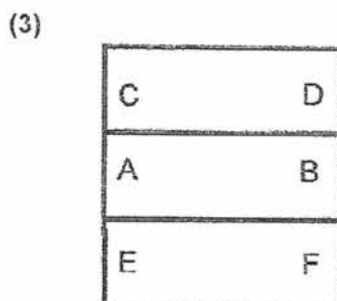
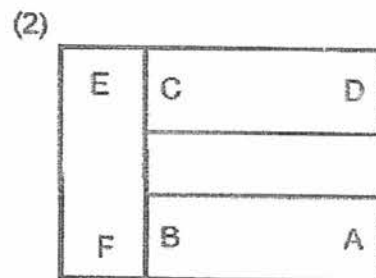
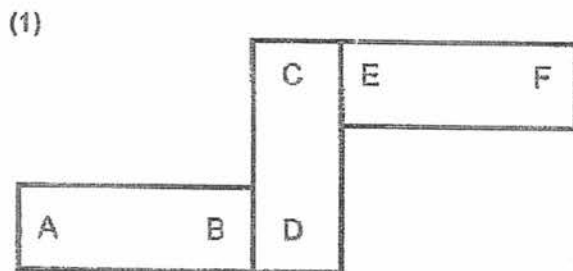

25. The diagram below shows a steel ball tied to the wooden block with a string. It suspended in mid-air with the help of a magnet. When sheet X was placed between the iron ball and the magnet, the iron ball dropped to the ground.

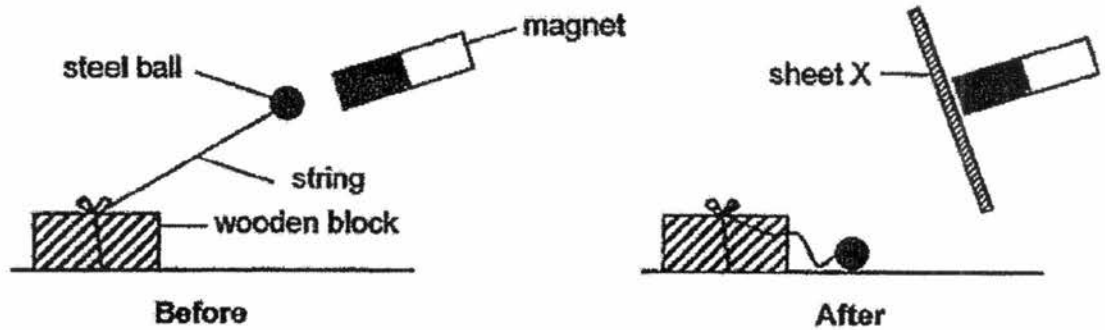

Which one of the following identifies sheet X and the conclusion drawn from the observation correctly?

	Sheet X	Conclusion
(1)	Nickel	Magnetism cannot pass through a magnetic object.
(2)	Copper	Magnetism cannot pass through a non-magnetic object.
(3)	Aluminium	Magnetism cannot pass through a magnetic object.
(4)	Iron	Magnetism cannot pass through a non-magnetic object.

Name: _____ Index No: _____ Class: P5 _____

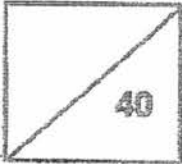

SECTION B (40 marks)

For questions 26 to 38, write your answers clearly in the spaces provided.
The number of marks is shown in brackets [] at the end of each question or part question.

26. The diagram below shows a family tree.

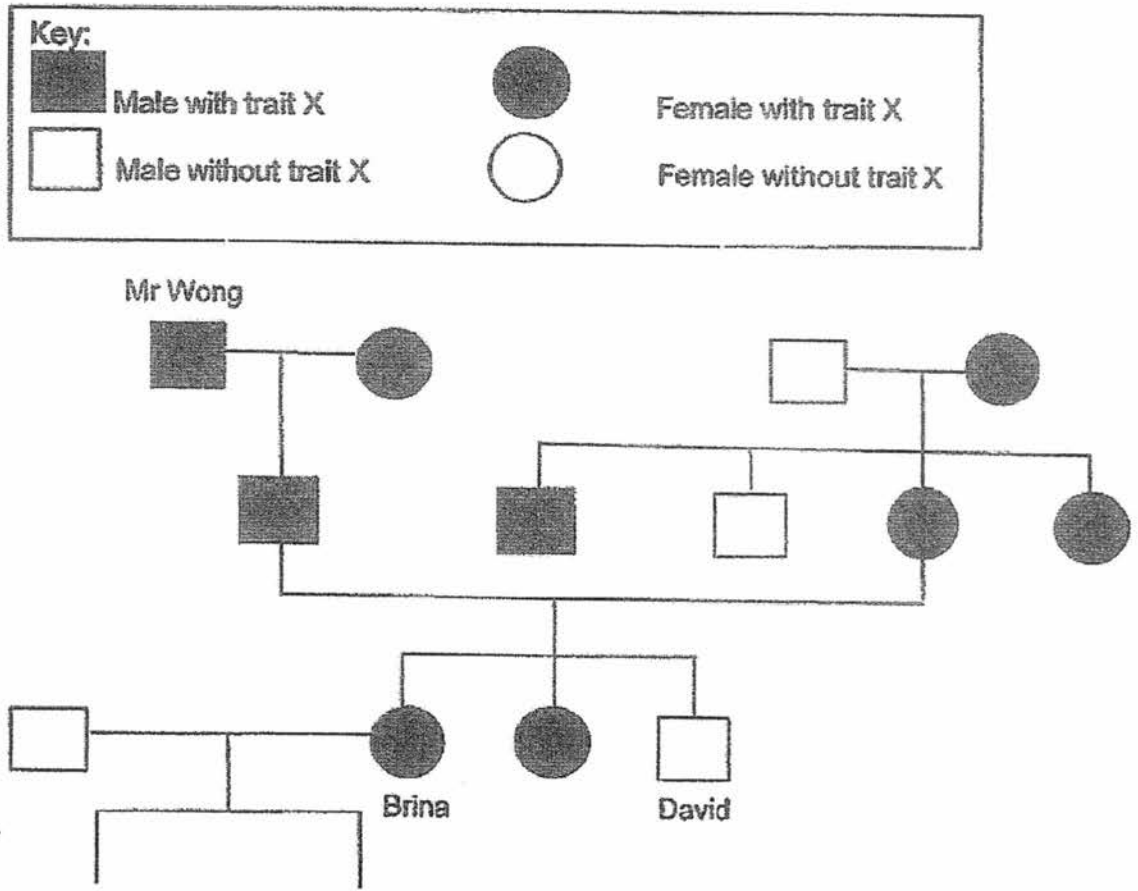

Based on the information above, answer the following questions.

- (a) Brina has two children, a boy and a girl, both with Trait X.
Complete this piece of information by drawing in the family tree above. [1]
- (b) How is Mr Wong related to David? [1]

SCORE	2
-------	---

P5-Science-SA2-2017

27. The diagrams below show two flowers, A and B.

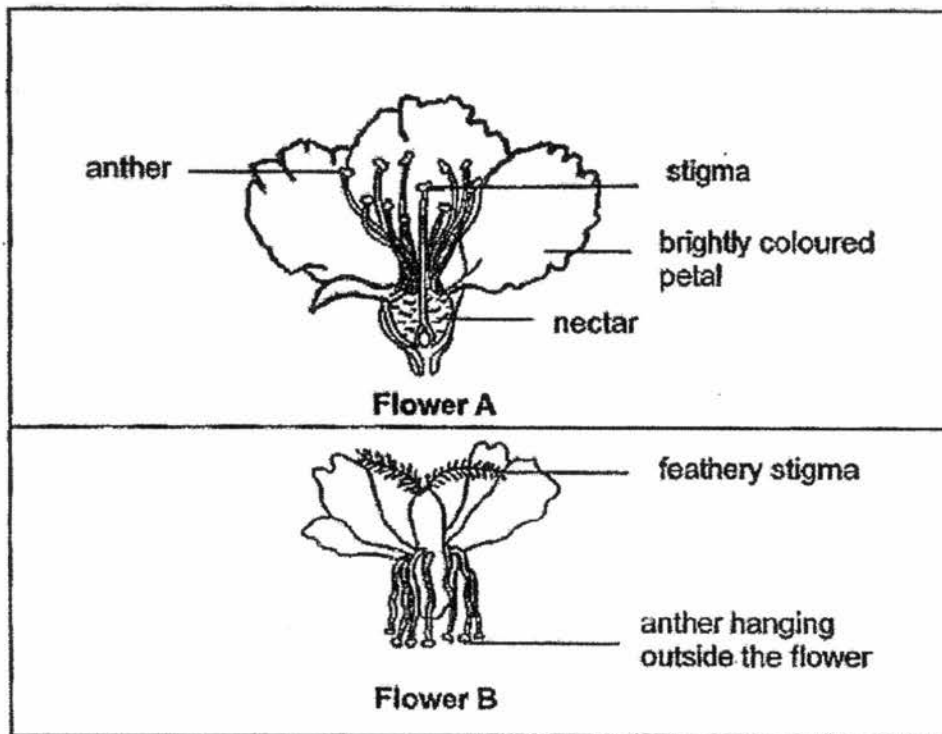

Based on the information above, answer the following questions. [4]

(a) Flower A

(i) Pollinated by: _____

(ii) Reason : _____

(b) Flower B

(i) Pollinated by: _____

(ii) Reason : _____

SCORE	4
-------	---

28. Yi Leng set up the following experiment to find out if plants take in water through their roots.

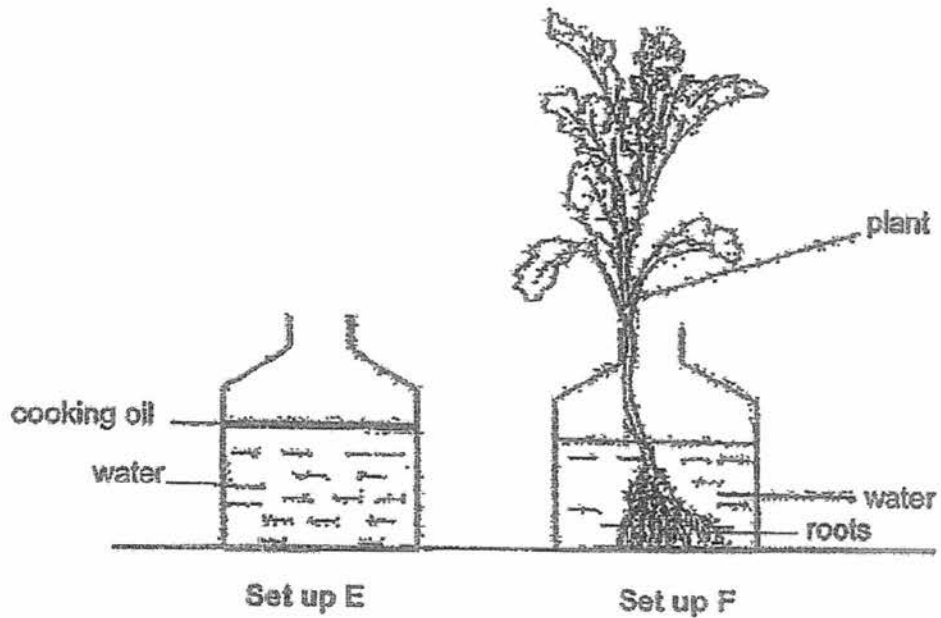

She used two identical containers and poured equal amount of water in each container. She recorded the water level into each container after one week. She found out that the water level decreased in Set-up F only.

(a) What was the purpose of set up E? [1]

(b) Her teacher commented that she did not carry out a fair test. Suggest what she should do to ensure a fair test. Give a reason for your answer. [2]

29. The diagram below shows the human digestive system.

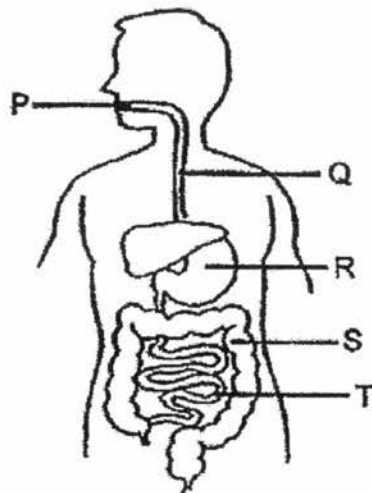

(a) At which part(s), P, Q, R, S or T, does digestion take place? [1]

(b) What happens at Part S during the digestion process? [1]

Organisms A are harmful organisms that live in the human small intestine due to poor personal hygiene. These harmful organisms get its food from the small intestine and damage the small intestinal wall.

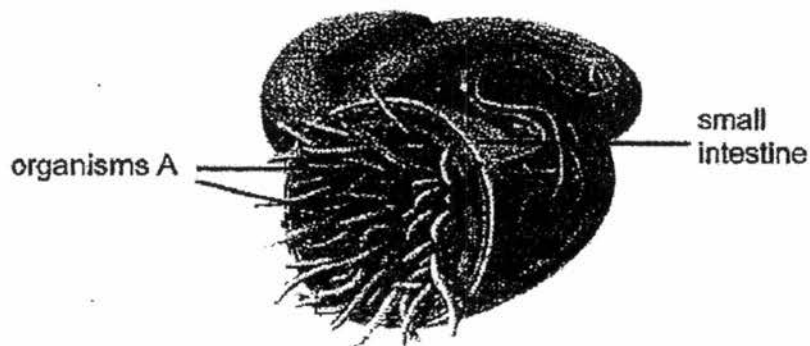

(c) Based on the information above, give a reason why a child infected with organisms A will not get enough nutrition. [1]

SCORE	3
-------	---

P5 Science SA2 2017

30. Faith examined three different cells under a microscope and recorded her observations in the table below. A tick (✓) indicates the presence of the part in the cell.

Cell Parts	Cell X	Cell Y	Cell Z
Cell Membrane	✓	✓	✓
Cytoplasm	✓	✓	✓
Nucleus	✓	✓	✓
Cell Wall		✓	✓
Chloroplast		✓	

Based on the information above, answer the following questions.

- (a) Faith identified Cell Z as a cheek cell. Do you agree with her?
Give a reason for your answer. [1]

- (b) Cell membrane is present in all three cells.
What is the function of the cell membrane? [1]

- (c) Which cell, X, Y or Z, most likely comes from the leaf of a plant?
Give a reason for your answer. [1]

31. The diagrams below show the circulatory system of a mammal and a fish. The arrows represent the blood vessels that carry blood from the lungs or gills to other parts of the body of a mammal and a fish respectively.

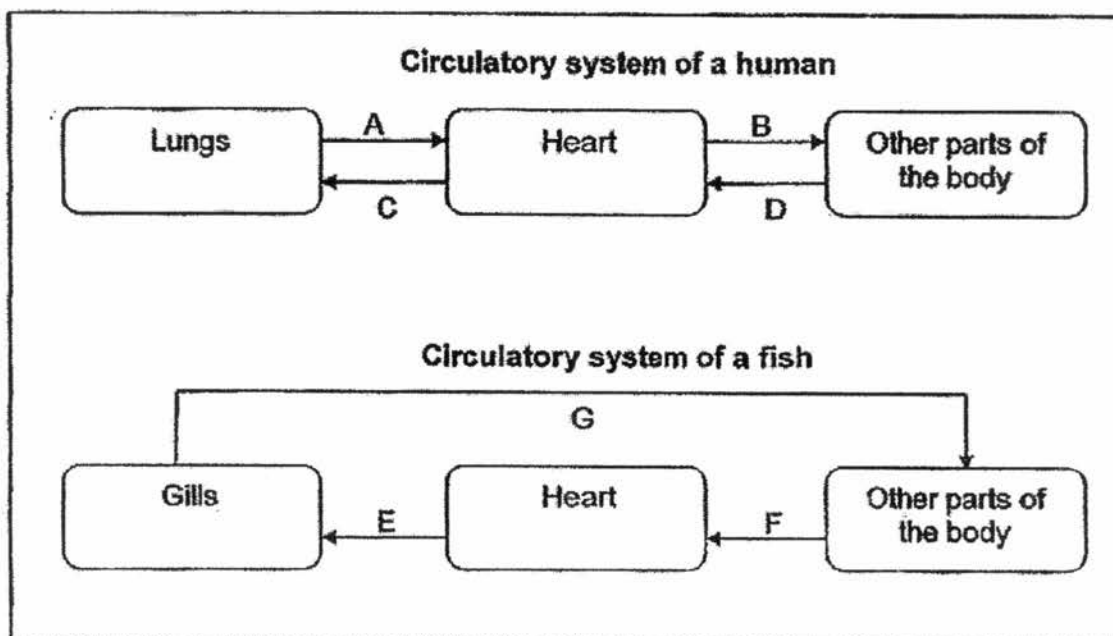

Compare the circulatory system between a human and a fish.

- (a) State a similarity.

[1]

- (b) State a difference.

[1]

SCORE	2
-------	---

32. Samantha removed part of the stem as shown in the diagram below and watered the plant with red-coloured water. At part B, the food-carrying tube has been removed. At part A, both the water and food-carrying tubes have been removed.

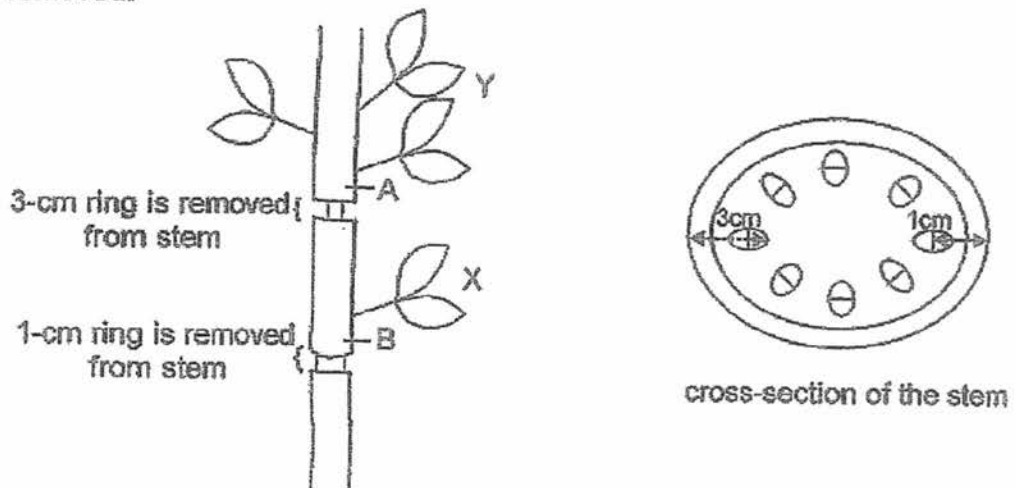

After one day, she observed that only the leaves between part A and B of the stem had turned red.

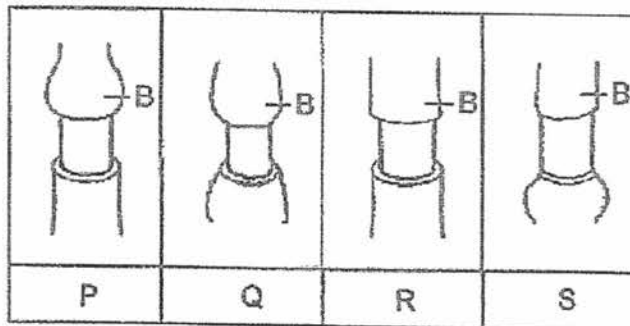

- (a) Which one of the above diagrams, P, Q, R or S, shows the observation made at part B of the stem after some time?
Explain your answer clearly. [2]

- (b) Samantha observed that the leaves above part A of the stem died after two days. Explain this observation clearly. [1]

SCORE	3
-------	---

33. Alison carried out an experiment with four pots of identical plants, W, X, Y and Z, using the same amount of identical type of soil. She removed different parts of the plants as shown below. She watered them daily with the same amount of water and observed them for a few days.

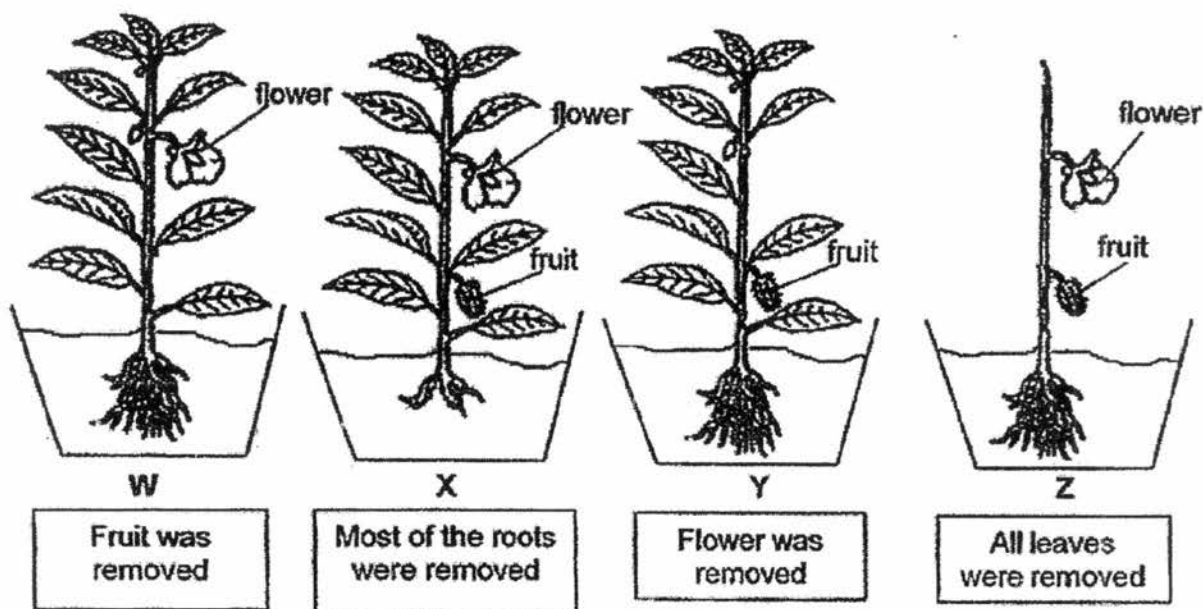

Alison recorded her observations and provided reason for her observations in the table below.

Fill in the box with either 'T' for True or 'F' for False.

[2]

Observation	Reason	True(T) / False(F)
Plant W dies	It does not have enough food as the fruit is removed.	
Plant X dies	It does not have enough water as most of the roots are removed.	
Plant Y dies	It does not have flowers to attract insects.	
Plant Z dies	It does not have leaves to make food for the plant.	

SCORE	2
-------	---

34. Sarah prepared a set-up using a sealed wooden box with a wooden plank glued on the side of the box as shown below. She cut an opening on the top of the box. She placed a healthy green plant under the wooden plank. She then covered the wooden box and placed it near a window. She watered the plant daily.

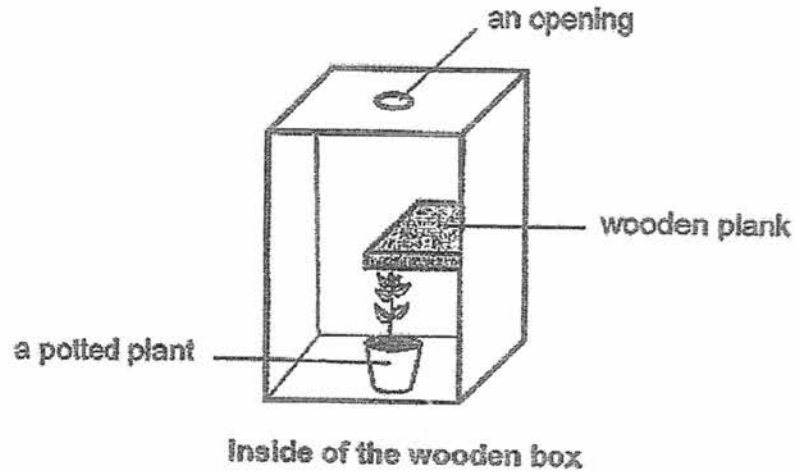

- (a) In the diagram below, draw what she would observe on the direction of the growth of the plant after two weeks. Use an arrow (\longrightarrow) to indicate the direction. [1]

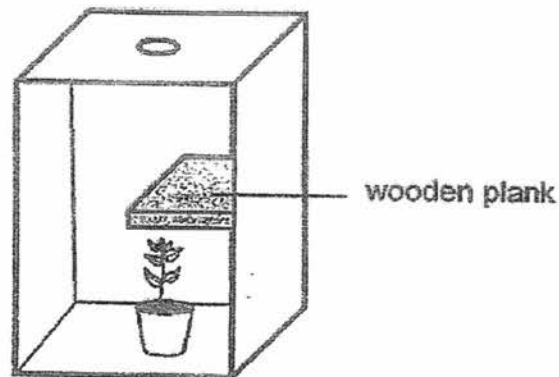

- (b) Explain your observation in (a). [2]

SCORE	3
-------	---

35. The diagram below shows a water cycle.

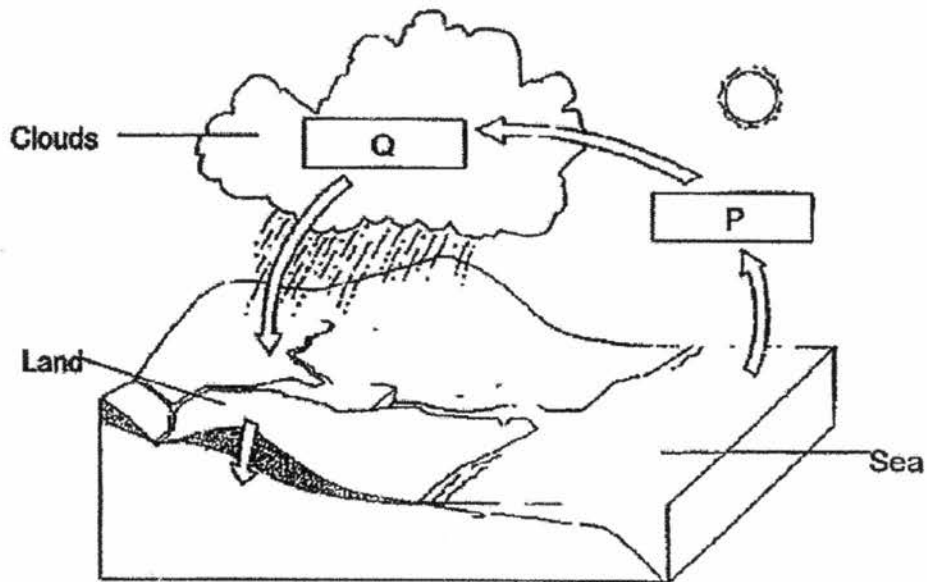

(a) Name the two processes, P and Q.

[2]

P: _____

Q: _____

The diagram below shows a set-up used to collect water from the environment.

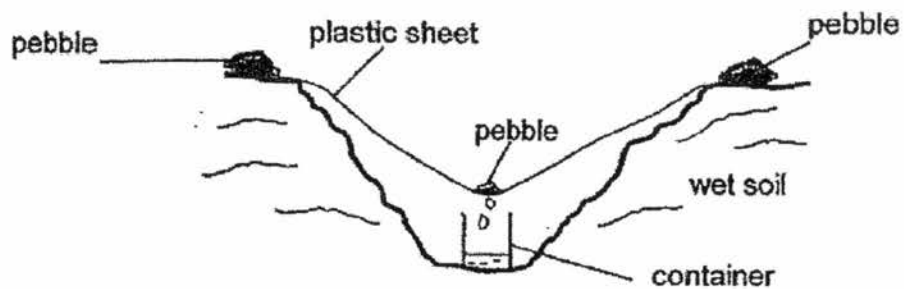

(b) Explain how water is collected in the container in the set-up above.

[2]

SCORE	4
-------	---

P5 Science SA2 2017

36. Joanne wanted to find out which cup is better to keep water hot for a longer period of time. She used the cups as shown below. Both cups are made of the same type of glass and can contain the same amount of water.

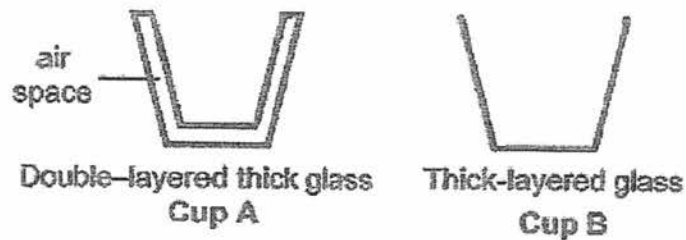

She poured 100ml of water into each glass and measured the temperature of water at the start of the experiment. After ten minutes, she measured the temperature of water in each cup and recorded the results as shown below.

- (a) Predict and write down the temperature of water in cup A after ten minutes in the table below. [1]

Cup	Temperature of water at the start of the experiment (°C)	Temperature of water after 10 minutes(°C)
A	70	
B	70	45

- (b) Explain your answer in part (a). [1]

Continue on next page

SCORE	2
-------	---

Continued from previous page

Joanne found out that holding a ripple-walled cup of coffee would be less hot compared to holding a smooth-walled cup of coffee. The two cups are shown below.

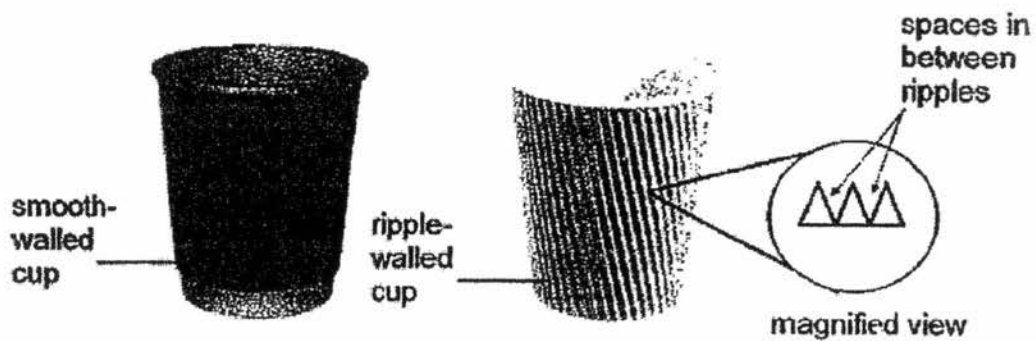

(c) Explain why it is less hot to hold a ripple-walled cup of hot coffee. [2]

SCORE	2
-------	---

37. Ahmad placed three rods, A, B and C, in the two circuits, X and Y, as shown below.

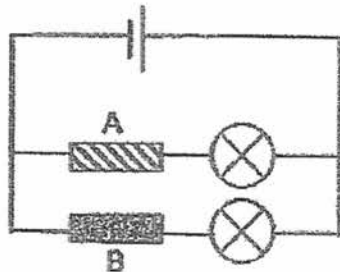

Circuit X

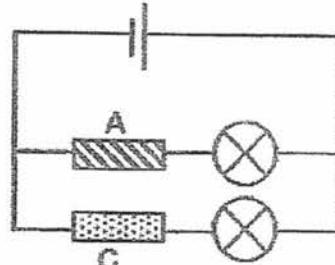

Circuit Y

He recorded his observations in the table below.

Circuit	Number of bulbs light up
X	1
Y	2

Ahmad set up another circuit using rods B and C as shown below. Three new identical bulbs, B1, B2 and B3, were connected in the circuit shown below.

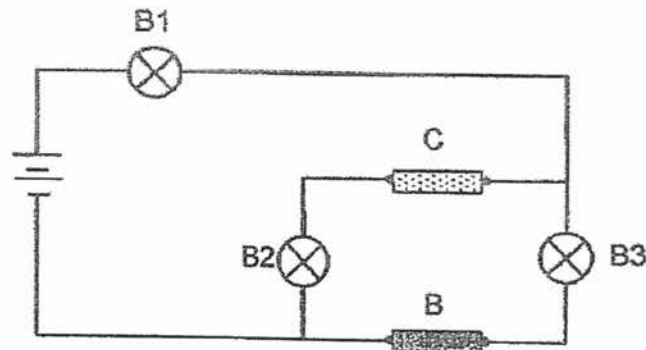

(a) Which bulb(s) will light up? Explain your answer.

[2]

Continue on next page

Continued from previous page

Ahmad set up another circuit as shown below using the metal clip.
The metal clip, when connected to positions 1, 2 or 3, will act like a switch.

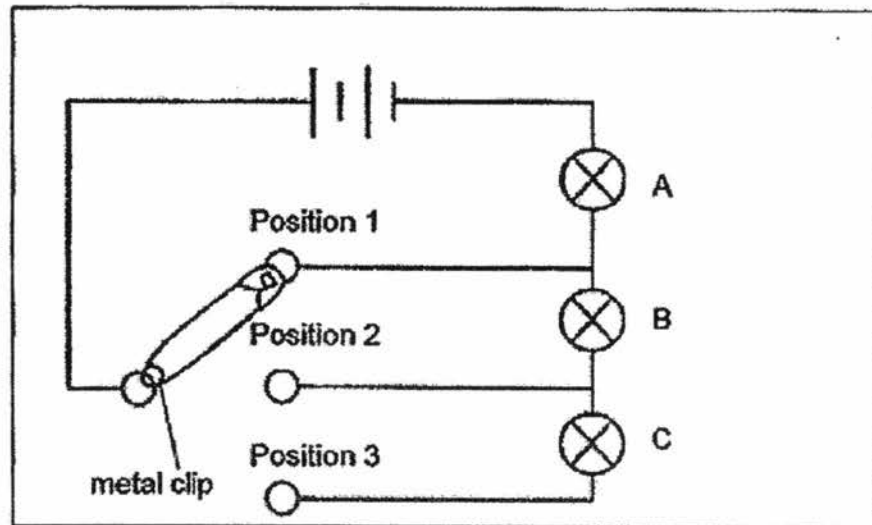

- (b) At which one of the positions, 1, 2 or 3, will the bulbs light up most dimly?
Explain your answer.

[2]

SCORE	2
-------	---

38. Kimberly observed that magnet X and object P were attracted as shown below.

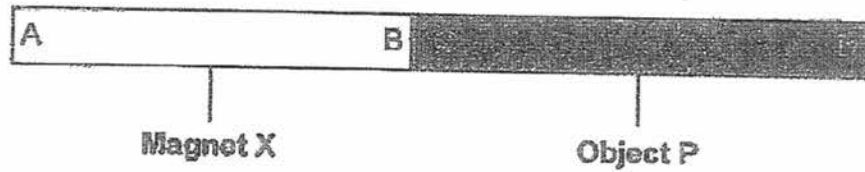

(a) Using only magnet X and object P, what should Kimberly do to find out if object P is a magnet? [2]

When Magnet X was placed over a tray of pins, it attracted fifteen pins. Kimberly dropped Magnet X several times and placed it over the same tray of pins.

(b) How many pins would be attracted to Magnet X? Give a reason for your answer. [1]

- End of Paper -

Settlers: Lim SH, Ng SP, Luo ZQ 37

SCORE	3
-------	---

P5 Science SA2 2017

EXAM PAPER 2017 (P5)

SCHOOL : RAFFLES GIRLS'

SUBJECT : SCIENCE

TERM : SA2

Q1	Q2	Q3	Q4	Q5	Q6	Q7	Q8	Q9	Q10
2	3	3	4	1	2	2	4	2	4
Q11	Q12	Q13	Q14	Q15	Q16	Q17	Q18	Q19	Q20
3	3	4	4	3	4	1	3	2	3
Q21	Q22	Q23	Q24	Q25					
3	2	1	2	1					

26)a)

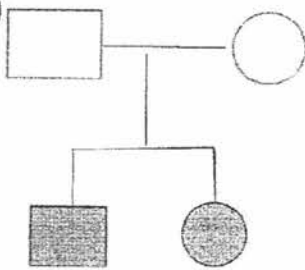

b) Mr Wong is David's grandfather.

27)a)i) Animals

ii) Flower A has brightly- coloured petals, has nectar and its anthers and stigma are within the flower.

27)a) b)i) Wind.

ii) Flower B has large, feathery stigma and its anthers are hanging outside the flower.

28)a) To act as a control set-up.

b) She should add cooking oil at the surface of the water for set-up F. The layer of cooking oil would prevent the water in the containers from evaporating and affecting the results of the experiment.

29)a) Parts P, R and T.

b) Water would be absorbed from the undigested food into the bloodstream at Part S.

c) Organism A will take the nutrients away from the human.

30)a) No. A cheek cell does not have a cell wall Cell Z has a cell wall.

b) The cell membrane controls the movement of substances into and out of the cell.

c) Cell Y. Cell Y has chloroplasts which contain chlorophyll to trap light and make food for the plant during photosynthesis.

31)a) Both the circulatory systems between a human and a fish have blood vessels to carry blood.

b) Blood passes through the heart twice in a complete circuit around the body in the circulatory of a human while blood passes through the heart once in a complete circuit around the body in the circulatory system of a fish.

32)a) Diagram P. Food made by Leaf X could not be transported down to the lower part of the plant below Part B as the food-carrying tubes were removed and will start to accumulate at Part B.

b) The water-carrying and food-carrying tubes were removed. Hence, the leaves above Part A could not receive any water. Without water, the leaves above Part A could not make food and will eventually die.

33) F, T, F, T

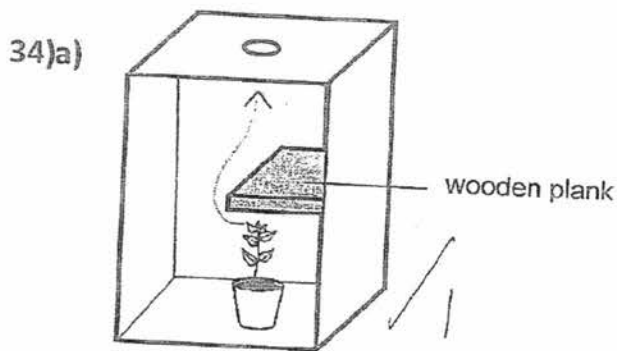

b) Light could enter the wooden box through the opening. The plant would grow towards the direction of the sunlight to trap light and make food for the plant during photosynthesis.

35)a) P : Evaporation.

Q : Condensation

b) Water from the wet soil gained heat and evaporated into water vapour. The warmer vapour came into contact with and lost heat to the cooler underside of the plastic sheet, condensing to form water droplets which dripped into the container.

36)a) 60

b) There are air spaces in between the glass for Cup A. As air is a poor conductor of heat, it would conduct heat away from the hot water to the surrounding more slowly than Cup B.

c) There are air spaces in between the ripples. As air is a poor conductor of heat, it would conduct heat away from the hot coffee to the hand slower than the smooth-walled up.

37)a) B1 and B2 will light up only rod C, which is an electrical conductor, so it forms a close circuit for electricity to flow through bulbs B1 and B2.

37)b) b)Position 3. At position 3, electric current could flow through Bulbs A, B and C, causing them to light up. There were more bulbs connected in series at position 3 than at position 1 and 2 . Hence, lesser electric current could flow through Bulbs 1,2,3, causing the bulbs to light up most dimly.

38)a)Placing ends B and D close together . If both ends repel each other, Object P is a magnet.

b)Magnet X would attract seven pins. When dropped several times, Magnet X lost some of its magnetic strength and hence, would attract fewer number of pins.