



**RAFFLES GIRLS' PRIMARY SCHOOL
END-OF-YEAR EXAMINATION
PRIMARY FIVE
2022**

**SCIENCE
(BOOKLET A)**

Name: _____ ()

Date : 27 October 2022

Class: P5 _____

Total Time : 1h 45min

INSTRUCTIONS TO CANDIDATES

1. Write your name, class and index number in the spaces provided above.
2. Do not turn over this page until you are told to do so.
3. Follow all instructions carefully.
4. Answer all questions.
5. For Question 1- 28, use 2B-pencil to shade your answers on the Optical Answer Sheet (OAS).

| | |
|-----------------------|----|
| Booklet A | 56 |
| Booklet B | 44 |
| Your score out of 100 | |
| Parent's signature | |

1. The diagram shows the female reproductive system of a human.

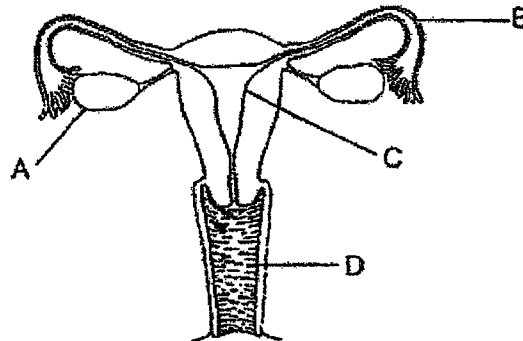

In which part of the female reproductive system will the fertilised egg develop into a baby?

- (1) A
 (2) B
 (3) C
 (4) D
2. The table shows the physical characteristics of four members in the Lim family.

| Family member | Eye colour | Hair colour | Hair type | Type of earlobe |
|-----------------|------------|-------------|-----------|-----------------|
| Mr Lim | Black | Black | Wavy | Attached |
| Mrs Lim | Brown | Brown | Straight | Attached |
| Issac (son) | Brown | Black | Straight | Detached |
| Inez (daughter) | Brown | Brown | Wavy | Detached |

Based on the information in the table, which of the following statement(s) is/are correct?

- A Inez inherited her wavy hair from her father.
 B Inez inherited more of her mother's traits than Issac.
 C Both Issac and Inez inherited detached earlobes from their parents.

- (1) A only
 (2) A and B only
 (3) B and C only
 (4) A, B and C

3. The diagrams show the conditions which the identical seeds in set-ups A, B, C and D were exposed to. Identical number of seeds were placed in each test tube.

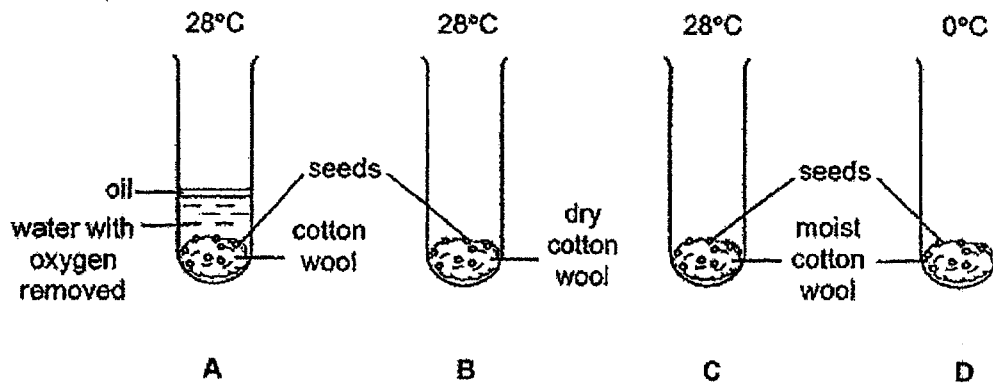

In which set-up(s) would the seeds germinate?

- (1) A only
- (2) C only
- (3) B and C
- (4) C and D

4. Study the distribution of seeds of plants R, S and T in the diagrams shown.

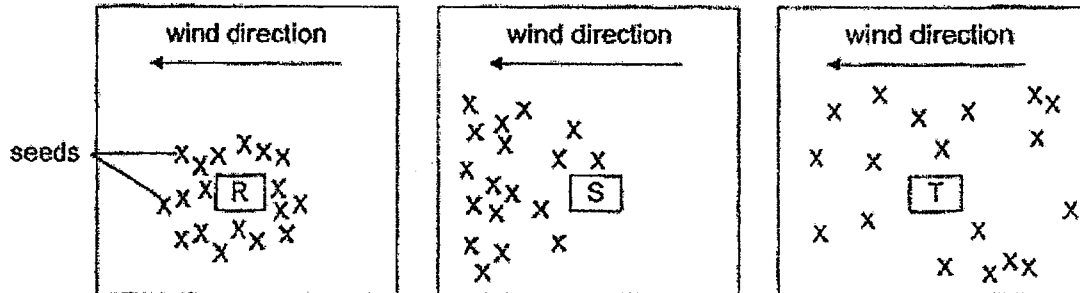

How were the seeds of plants R, S and T dispersed?

| | R | S | T |
|-----|------------------|------------------|------------------|
| (1) | Animal | Explosive action | Wind |
| (2) | Explosive action | Wind | Animal |
| (3) | Explosive action | Animal | Wind |
| (4) | Wind | Animal | Explosive action |

5. Which of the following is/are function(s) of leaves?

- A Make food
- B Take in water
- C Take in and give out gases

- (1) A only
- (2) A and B only
- (3) A and C only
- (4) B and C only

6. The diagrams show four plants.

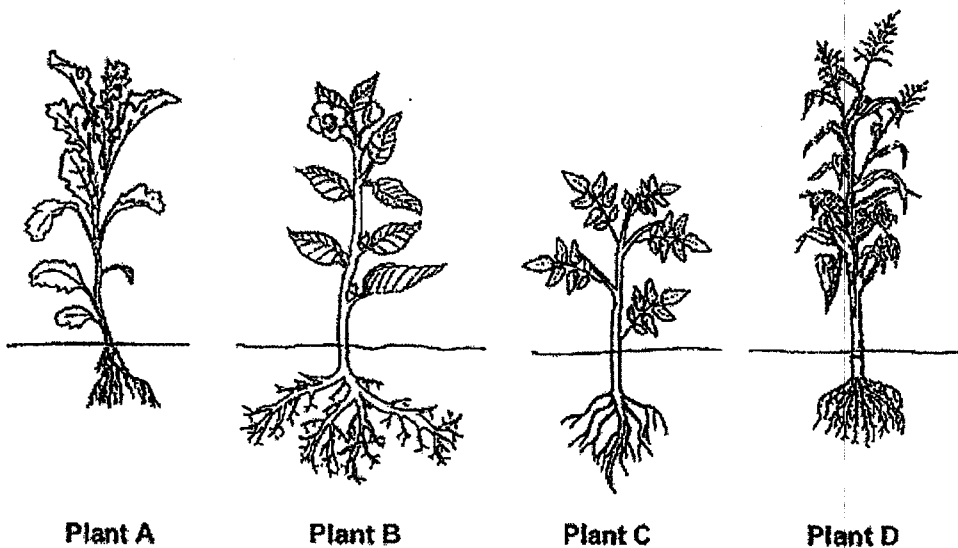

During a heavy rain, which of these plants is most likely to be uprooted first?

- (1) Plant A
- (2) Plant B
- (3) Plant C
- (4) Plant D

7. Which of the following function of the human body system is not correct?

| | Human body system | Function |
|-----|--------------------|--|
| (1) | Skeletal system | Gives the body its shape |
| (2) | Digestive system | Breaks down food into simpler substances |
| (3) | Muscular system | Enables the body to move |
| (4) | Circulatory system | Takes in oxygen and removes carbon dioxide from the body |

8. The diagram shows a human digestive system with some of its organs labelled A, B, C and D.

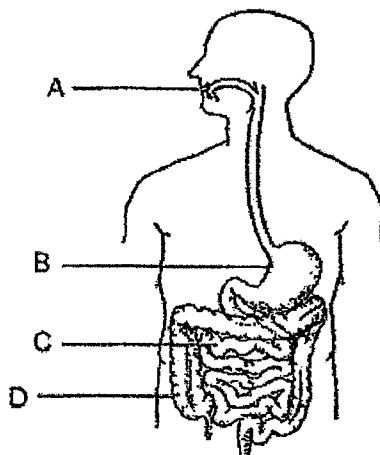

The graph shows the amount of undigested food at various parts of the digestive system.

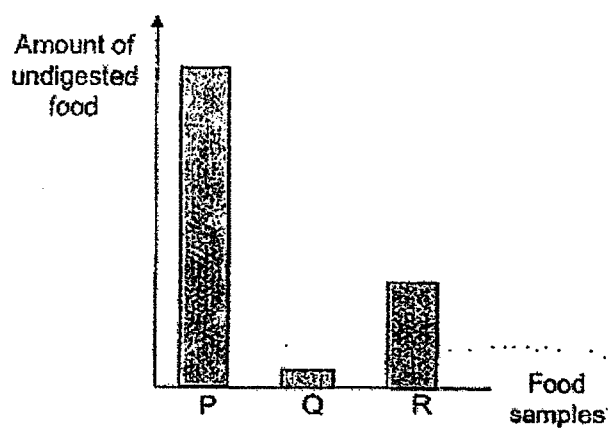

Which of the following correctly shows the organ where the food sample was obtained from?

| | Organ | Food sample |
|-----|-------|-------------|
| (1) | A | R |
| (2) | B | Q |
| (3) | C | Q |
| (4) | D | P |

9. The diagram shows cells M and N.

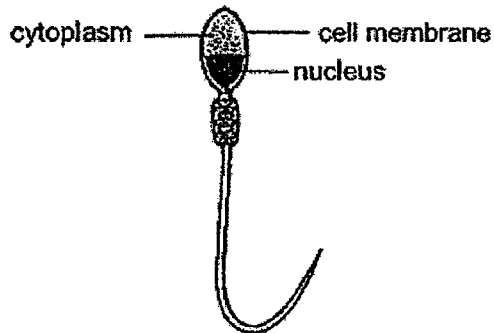

Cell M

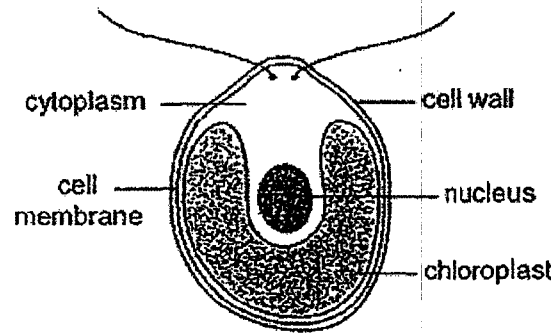

Cell N

Which one of the following correctly shows the difference between cells M and N?

- (1) Cell M will be able to reproduce but not cell N.
- (2) Cell M will not burst when placed in water but cell N will burst when placed in water.
- (3) Cell N will be able to trap sunlight to make food but not cell M.
- (4) Cell N will only allow some substances to enter the cell but cell M will allow all substances to enter.

10. Which of the following statement(s) is/are true?

- A Air is needed for living things to survive.
- B Less nitrogen is breathed out than breathed in.
- C A runner produces more carbon dioxide during a run than when he is at rest.
- D Oxygen, carbon dioxide, water vapour and nitrogen enter the respiratory system during breathing.

- (1) A only
- (2) B and C only
- (3) A and D only
- (4) A, C and D only

11. The diagram shows the flow of blood, represented by the arrows, in the human circulatory system.

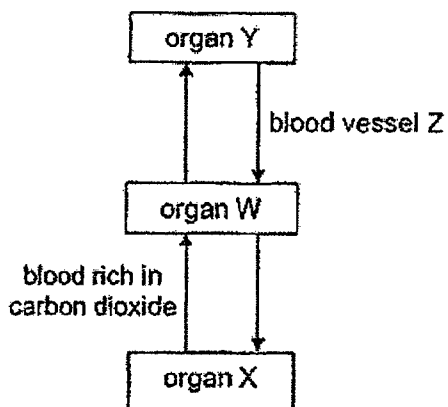

Which of the following best represents organs W, X and Y and the concentration of the gas in the blood in blood vessel Z?

| | Organ W | Organ X | Organ Y | Blood in blood vessel Z |
|-----|---------|-----------------|-----------------|-------------------------|
| (1) | Heart | Lungs | Small intestine | Rich in carbon dioxide |
| (2) | Heart | Small intestine | Lungs | Rich in oxygen |
| (3) | Lungs | Small intestine | Heart | Rich in carbon dioxide |
| (4) | Lungs | Small intestine | Heart | Rich in oxygen |

12. The diagram shows how water and substance E are transported to parts, A, B, C and D of a plant.

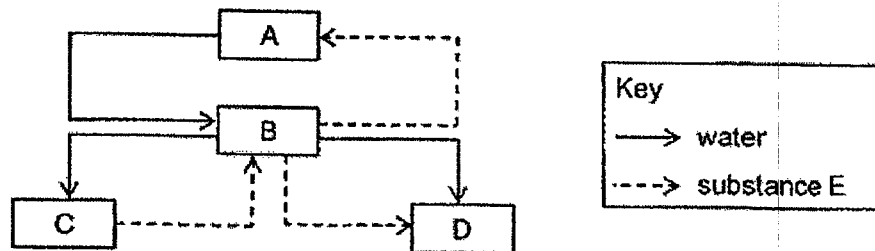

What do parts A, B and C represent?

| | A | B | C |
|-----|--------|--------|------|
| (1) | Flower | Root | Leaf |
| (2) | Leaf | Flower | Stem |
| (3) | Root | Leaf | Stem |
| (4) | Root | Stem | Leaf |

13. A stalk of plant C was split into two as shown in the diagram. Each section was placed into different coloured water.

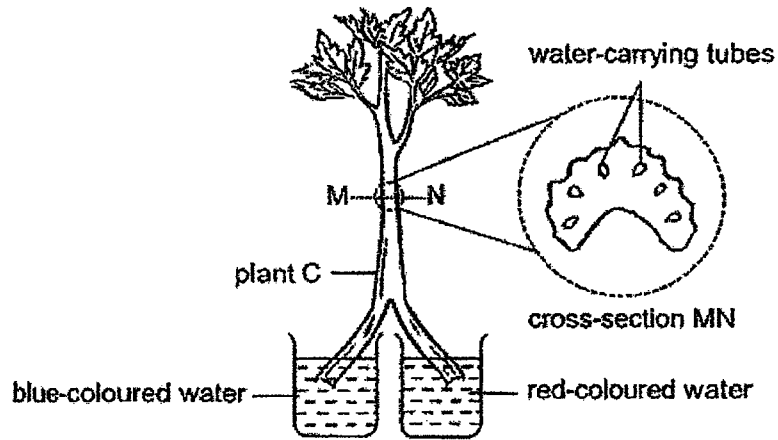

Which one of the following would be the observation made on the colour(s) of the water-carrying tube, if a cut was made at section MN?

(1)

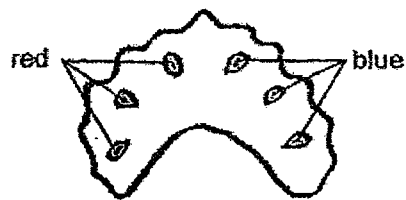

(3)

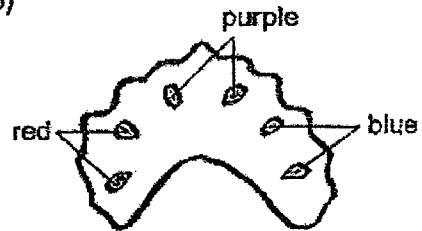

(2)



(4)

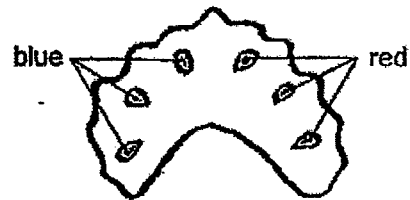

14. Four identical beakers, W, X, Y and Z, filled with the same amount of water were exposed to different conditions as shown in the table.

| Beakers | W | X | Y | Z |
|------------|---------------|-------------------|----------------|--------------------|
| Conditions | Cool Windy | Cool Not windy | Sunny Windy | Sunny Not windy |

Which of the following beakers will contain the least amount of water after one day?

- (1) Beaker W
 - (2) Beaker X
 - (3) Beaker Y
 - (4) Beaker Z
15. The diagram shows a cup of hot coffee placed on the table.

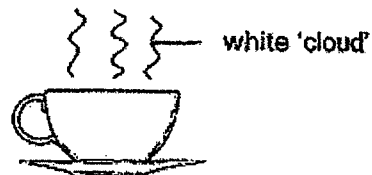

Which of the following processes resulted in the formation of the white 'cloud'?

- (1) Boiling
- (2) Freezing
- (3) Evaporation
- (4) Condensation

16. • Three identical beakers, A, B and C, were filled with equal volume of water of different temperatures. The beakers were covered with identical lids and placed on a table in a room with a temperature of 29°C . Water droplets were formed on cups B and C are shown in the diagram.

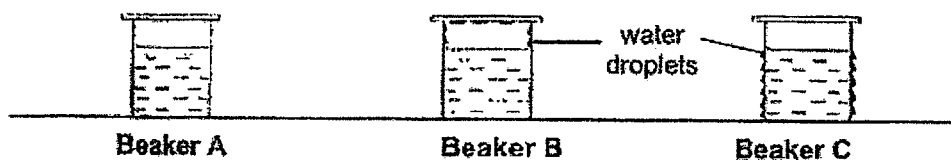

The graph shows the change in temperature in the water over a period of time.

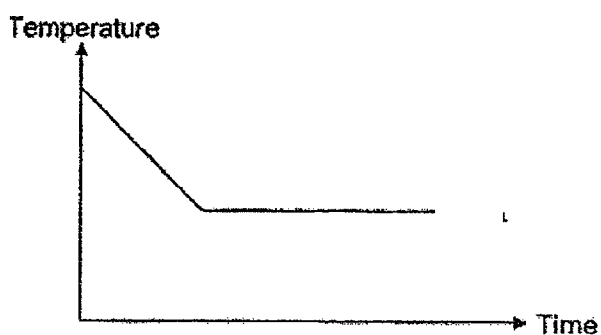

Which of the following beaker(s) contained water which had the temperature change as shown in the graph?

- (1) Beaker A only
- (2) Beaker B only
- (3) Beaker C only
- (4) Beakers B and C only

17. Tina bought a hot pizza and brought it home. When she opened the box at home, she observed that the underside of the pizza box cover was damp as shown in the diagram.

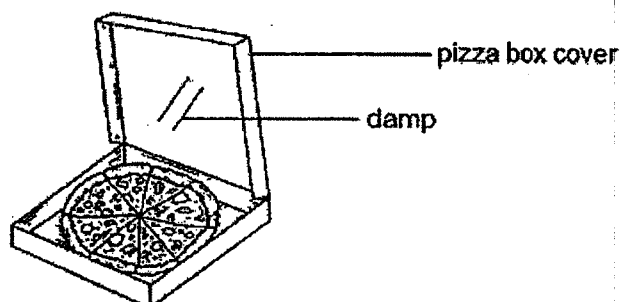

Which of the following would cause the underside of the pizza box cover to be less damp?

- A Use a metal pizza box.
- B Use a styrofoam pizza box.
- C Make holes on the pizza cover.
- D Leave the pizza box cover slightly open.

- (1) A and B only
- (2) C and D only
- (3) A, C and D only
- (4) A, B, C and D

18. Allison looks into a claw machine placed in a bright arcade room as shown in the diagram.

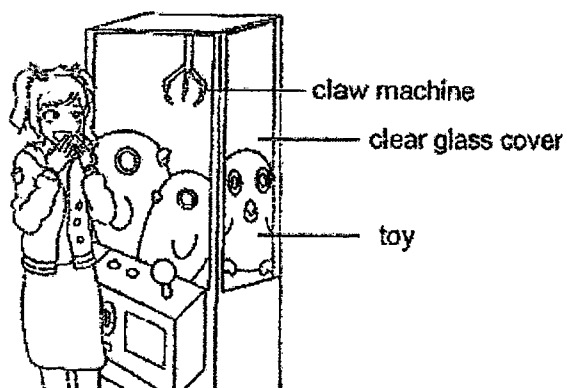

Which statement explains why she can see the toys in the machine?

- (1) The toy gave out light that entered her eyes.
- (2) Most light passed through the toys and entered her eyes.
- (3) Some light was reflected from the glass cover and entered her eyes.
- (4) Most light reflected by the toys passed through the glass cover and entered her eyes.

19. The diagram shows three objects with the following heights and widths.

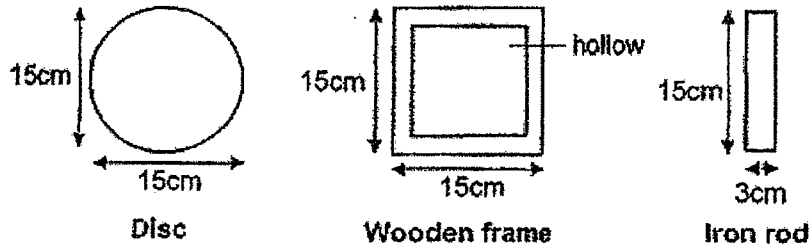

The objects were placed one at each position, X, Y and Z, from the torch as shown in the diagram. The shadows were cast on a screen.

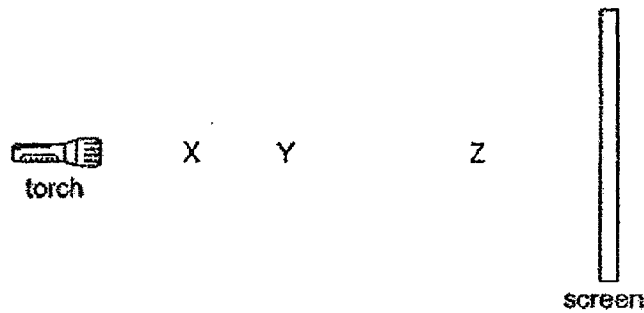

Which of the following are possible shadows that could be casted on the screen?

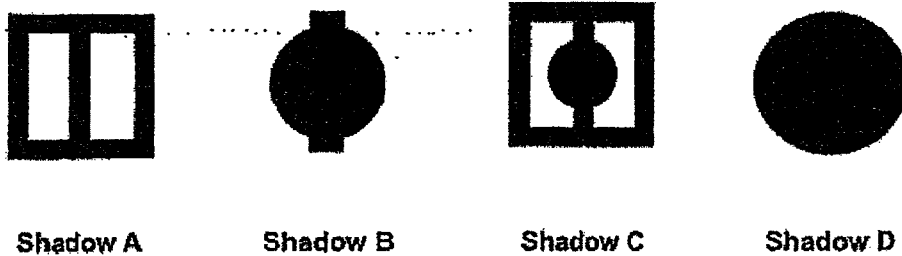

- (1) A and C only
- (2) B and D only
- (3) A, B and C only
- (4) B, C and D only

20. Ben prepared an experimental set-up to find out the degree of transparency of materials J, K and L as shown in the diagram.



He recorded the amount of light that passed through each material over a period of time in the table. He observed that the amount of light from the torch was 2000lux.

| Materials | Amount of light (lux) |
|-----------|-----------------------|
| J | 1000 |
| K | 20 |
| L | 400 |

Which graph shows his results correctly?

(1)

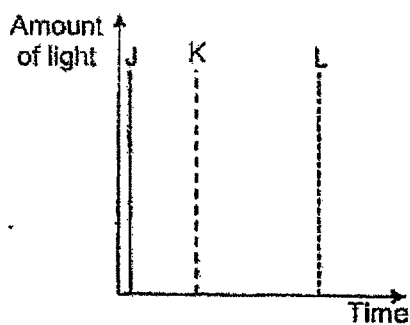

(2)

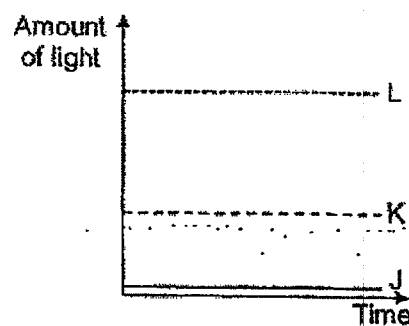

(3)

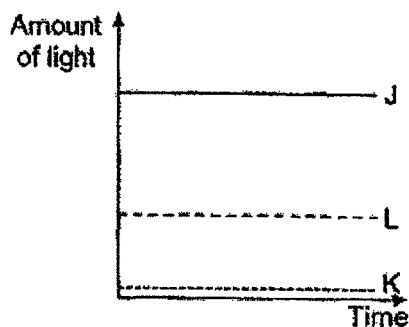

(4)

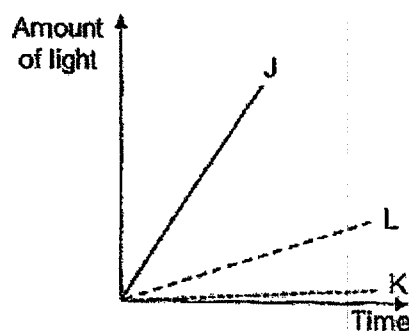

21. The diagram shows ice cubes in a cup of hot water.

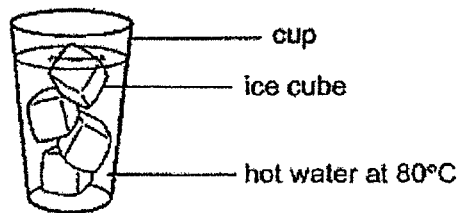

Which of the following observations about the ice cubes is possible after a few minutes?

| | Size of ice cubes | Direction of heat flow | |
|-----|-------------------|------------------------|-------|
| | | From | To |
| (1) | Became smaller | Ice | Water |
| (2) | Became smaller | Water | Ice |
| (3) | Remained the same | Ice | Water |
| (4) | Remained the same | Water | Ice |

22. Gordon has two bowls, A and B, made of the same material. He placed equal amount of hot rice into each bowl. He could hold bowl A without feeling much heat from the hot rice on his index finger but bowl B was too hot to hold.

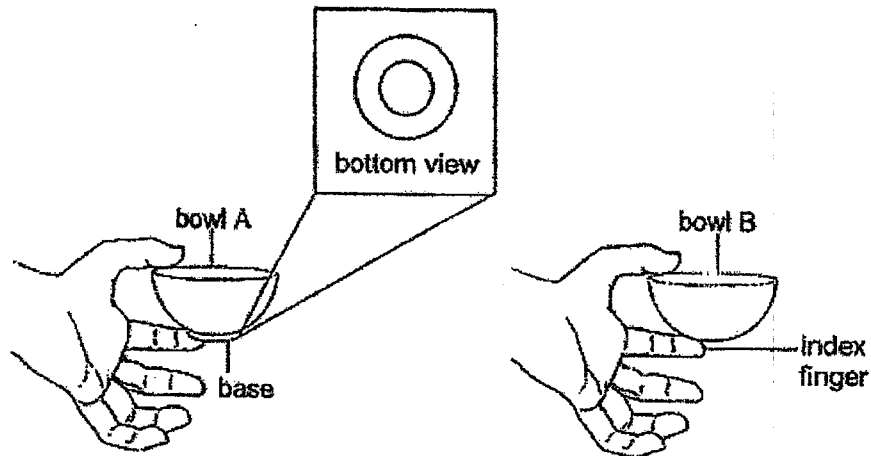

Which of the following best explains why Gordon could hold bowl A without feeling much heat from the hot rice on his index finger but bowl B was too hot to hold?

- (1) Bowl B is a poor conductor of heat.
- (2) Bowl A is a good conductor of heat.
- (3) Bowl B is a good conductor of heat but not the base of bowl A.
- (4) Distance from the heat source to the index finger is further in bowl A.

23. Hasan has two cooking pans stuck together as shown in the diagram.

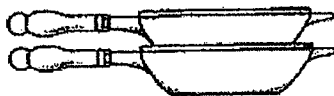

Which of the following method(s) could he use to separate the two cooking pans most easily?

A

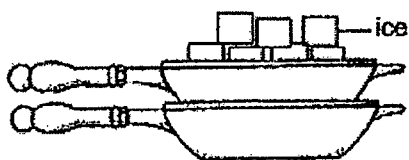

B

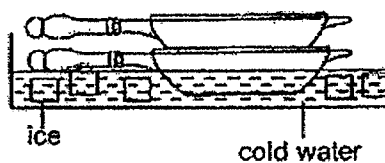

C

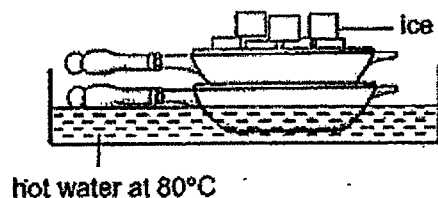

D

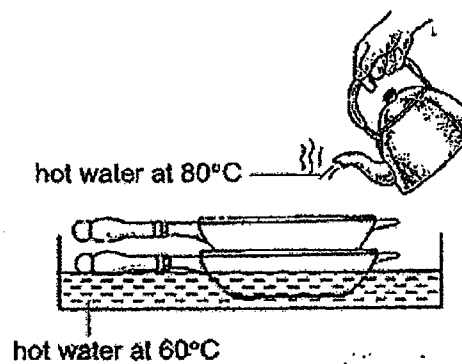

- (1) A only
 (2) A and C only
 (3) B and D only
 (4) C and D only

24. The diagram shows a closed circuit that consists of identical bulbs.

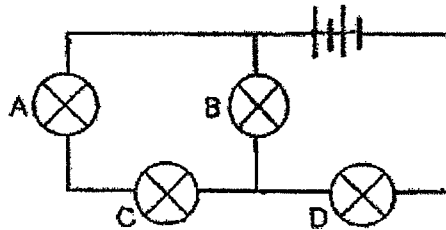

Which of the following bulbs, A, B, C or D, when removed, will cause none of the bulbs to light up?

- (1) A
 - (2) B
 - (3) C
 - (4) D
25. The diagram shows a closed circuit that consists of identical bulbs.

There was least number of bulbs that light up in the circuit when one of the switches was opened.

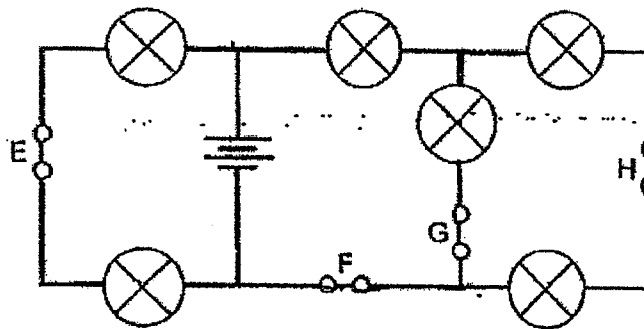

Which one of the following switches was most likely to be opened?

- (1) E
- (2) F
- (3) G
- (4) H

26. Caleb carried out an experiment to find out which materials, Q, R or S, can conduct electricity. He connected materials Q, R and S to the circuit at positions 1, 2 and 3 respectively as shown in the diagram.

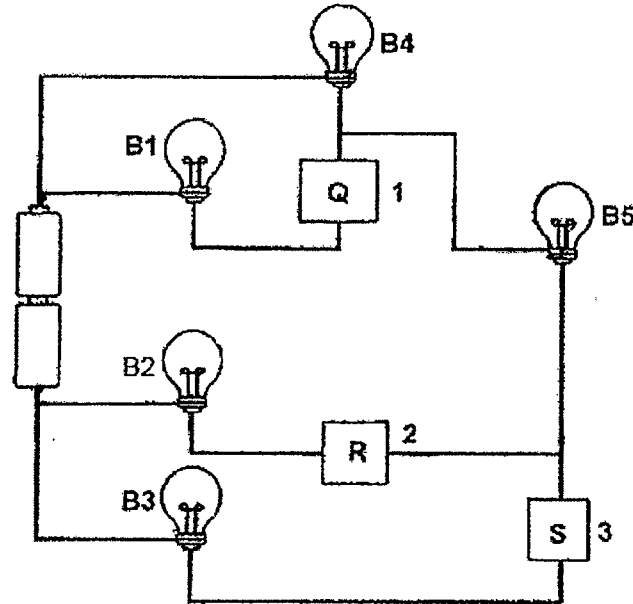

He observed that only bulbs B2, B4 and B5 lit up. He then rearranged the materials S, Q and R and connected to the circuit at positions 1, 2 and 3 respectively.

Which of the following bulbs would light up after the re-arrangement of the materials?

- (1) B1 and B4
- (2) B1, B2 and B5
- (3) B1, B4 and B5
- (4) B3, B4 and B5

27. The diagram shows how an iron nail was made into a temporary magnet using the stroke method. A bar magnet was used to stroke the iron nail repeatedly in the same direction thirty times as shown in the diagram.

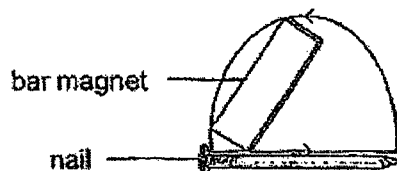

Which one of the following would increase the magnetic strength of the magnetised iron nail?

- (1) Drop the iron nail multiple times.
 - (2) Increase the size of the bar magnet.
 - (3) Stroke the iron nail in the opposite direction fifty times.
 - (4) Stroke the iron nail in the same direction another fifty times.
28. Thomas set up the following experiment to find out if strips P, Q and R were made of magnetic material. He placed the strips between two bar magnets. His observations are shown in the diagram.

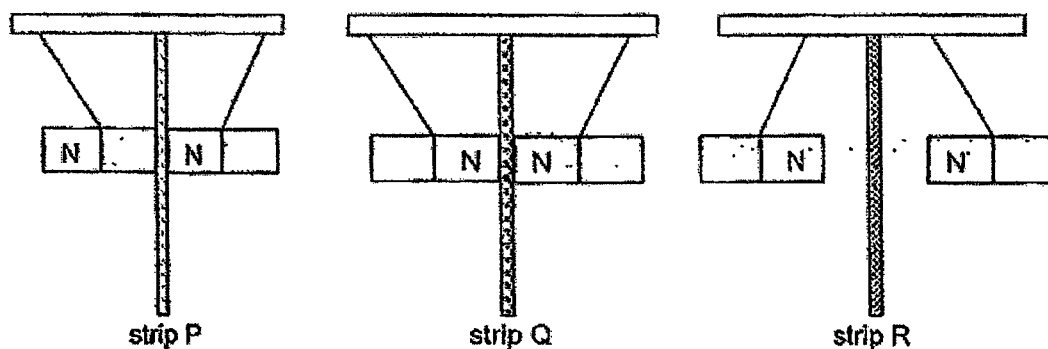

Which of the following strip(s) is/are definitely made of a magnetic material?

- (1) Strip P only
- (2) Strip Q only
- (3) Strip R only
- (4) Strips P and R only



**RAFFLES GIRLS' PRIMARY SCHOOL
END-OF-YEAR EXAMINATION
PRIMARY FIVE
2022**

**SCIENCE
(BOOKLET B)**

Name: _____ ()

Date : 27 October 2022

Class: P5 _____

Total Time : 1h 45min

INSTRUCTIONS TO CANDIDATES

1. Write your name, class and index number in the spaces provided above.
2. Do not turn over this page until you are told to do so.
3. Follow all instructions carefully.
4. Answer all questions.
5. For questions 29-41, write your answers clearly in the spaces provided.
6. The number of marks is shown in brackets [] at the end of each question or part question.

| | |
|------|----|
| Mark | 44 |
|------|----|

29. The diagrams show the process of the male sex cell fusing with the female sex cell in human and plant respectively.

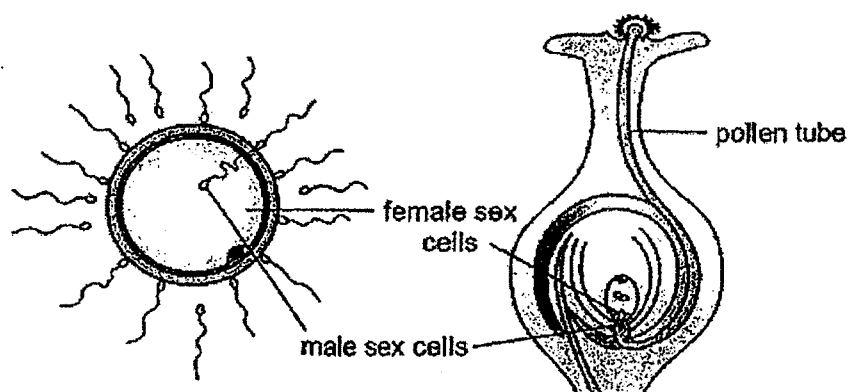

Human

Plant

- (a) State the process shown in the diagrams.

[1]

- (b) Explain why large numbers of male sex cells are introduced into the female reproductive system each time during the process of reproduction.

[1]

Continue on page 23

| | |
|-------|---|
| Score | 2 |
|-------|---|

Continued from page 22

- (c) Which of the following statement(s) describe(s) the similarity between pollen grains and sperms? Put a (✓) in the correct box(es). [1]

| Statement | Tick (✓) |
|---|--------------------------|
| Both the pollen grains and sperms are produced by the female parts. | <input type="checkbox"/> |
| Both the pollen grains and sperms can move from place to place on their own. | <input type="checkbox"/> |
| Both the pollen grains and sperms carry genetic information that can be passed down to their offspring. | <input type="checkbox"/> |

| | |
|-------|---|
| Score | 1 |
|-------|---|

30. Study the two flowers, X and Y, as shown in the diagram.

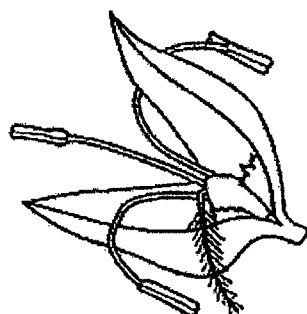

Flower X

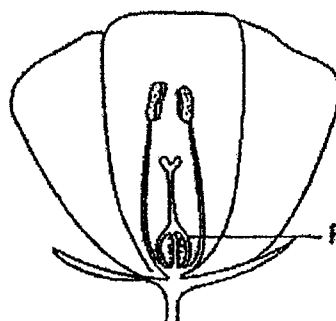

Flower Y

(a) Based on the diagram, identify the methods of pollination for flowers X and Y by putting a (✓) in the correct boxes. [1]

| Flower | X | Y |
|-------------------|---|---|
| Insect pollinated | | |
| Wind pollinated | | |

(b) State two characteristics of flower Y that enable the flower to be pollinated by the method identified in part (a). [2]

- (i) _____
- (ii) _____

(c) What does part P develop into after fertilisation? [1]

| | |
|-------|---|
| Score | 4 |
|-------|---|

31. Paula poured 20ml of water into each of the three test tubes X, Y and Z. Then she placed identical plants into each test tube as shown in the diagrams. The roots of the plant in test tube X were coated with wax.

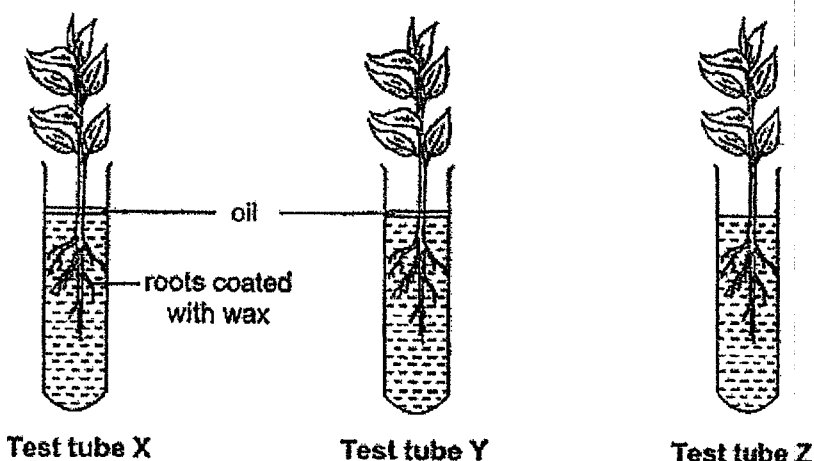

Three days later, Paula recorded the amount of water left in each test tube in the table shown.

| Test tube | Volume of water at the start (ml) | Volume of water at the end of three days (ml) |
|-----------|-----------------------------------|---|
| X | 20 | 20 |
| Y | 20 | (a) _____ |
| Z | 20 | 2 |

- (a) What is the possible volume of water left in test tube Y at the end of three days? Write your answer in the table above. [1]
- (b) Give your reason in your answer in (a).
-
-
- (c) Noah told Paula that she only needed to use two test tubes for her experiment. Which two test tubes should Paula use to ensure a fair test? [1]
-

| | |
|-------|---|
| Score | 3 |
|-------|---|

32. Jane would like to find out if the size of the food substance affects the time taken for it to be completely digested.

She set up three set-ups, P, Q and R, with the same amount of identical food substance and equal amount of digestive juice. Set-ups Q and R contained the food substance broken into smaller pieces as shown in the diagram.

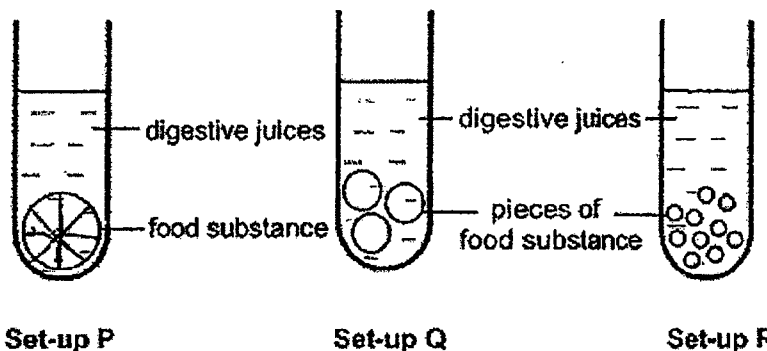

She recorded the results in the table.

| Set-up | P | Q | R |
|---|----|----|---|
| Time taken for the food substance to be completely digested (min) | 40 | 25 | 8 |

- (a) Based on the results, how does the size of the food substance affect the time taken for the food to be completely digested? [1]

- (b) Based on the experiment above, explain how chewing helps in the digestion process. [2]

| | |
|-------|---|
| Score | 3 |
|-------|---|

33. The diagram shows cell K.



Cell K

(a) In the diagram, name and label the part of cell K that controls the cell activities. [1]

The diagram shows cells L and M from a plant.

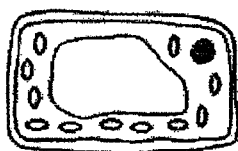

Cell L



Cell M

(b) Identify the part of the plant the cell came from and state a reason for your answer. [2]

| Cell | Part of plant the cell came from | Reason for your answer |
|------|----------------------------------|------------------------|
| L | | |
| M | | |

Cell L was put in a solution and left for five hours. After five hours, it was observed that the cell had shrunk as shown in the diagram.

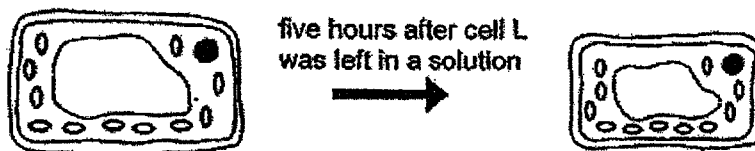

(c) Which part of the cell is responsible for the shrinking of the cell? [1]

| | |
|-------|---|
| Score | 4 |
|-------|---|

34. The diagrams show the different parts in the respiratory systems of a human and a fish.

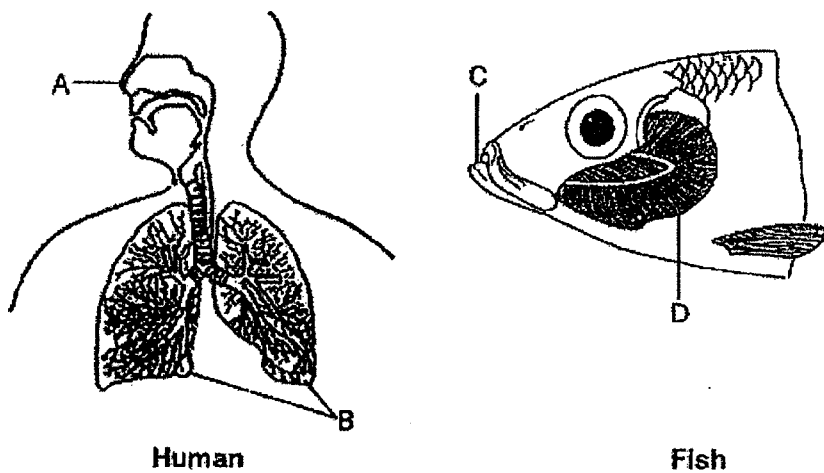

- (a) At which part, A, B, C or D, does gaseous exchange take place in a human and a fish respiratory systems? [1]

Human: _____

Fish: _____

- (b) Describe how the fish gets oxygen for its survival. [2]

| | |
|-------|---|
| Score | 3 |
|-------|---|

35. The diagram shows Carine's heart rate during her morning exercise.

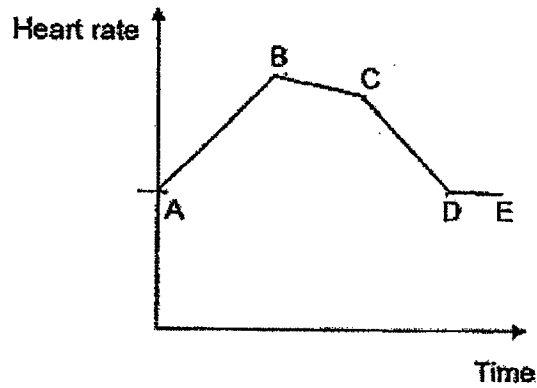

- (a) State the parts, AB, BC, CD or DE, of the graph that match the activities. [1]

| Activity | Part of the graph |
|---------------|-------------------|
| Running | |
| Brisk walking | |

- (b) Explain why the Carine's heart rate decreases from C to D during her morning exercise. [2]

| | |
|-------|---|
| Score | 3 |
|-------|---|

36. Omar observed the growth of four pots of identical plants, A, B, C and D, using the same amount of identical type of soil. Different parts of the plants were removed as shown in the diagrams.

The plants were placed in the garden and Omar watered the plants daily with the same amount of water. He observed the plants over a same period of time.

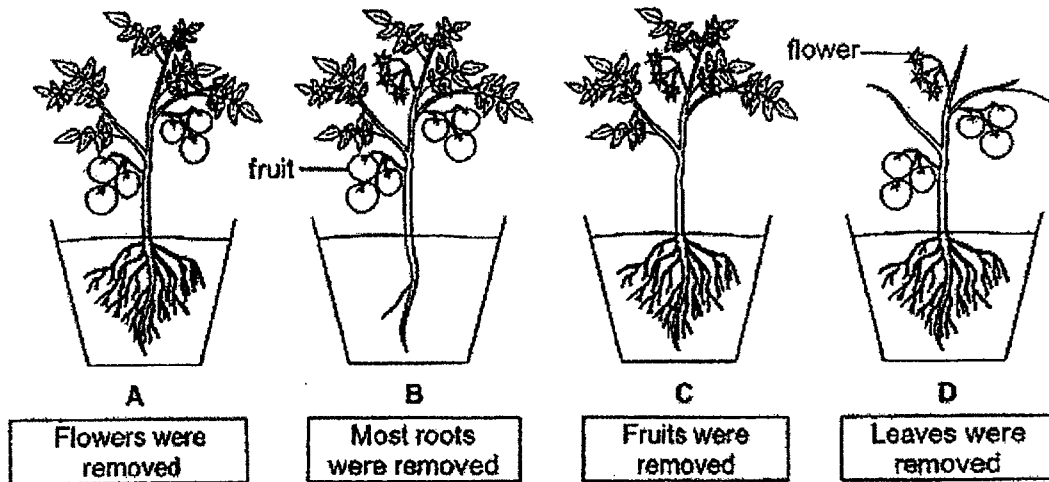

Omar recorded his observations and provided reasons for his observations in the table.

- (a) Put a tick (✓) in the box(es) that show(s) the correct observation and its corresponding reason. [2]

| Observation | Reason | Tick (✓) |
|--------------|--|----------|
| Plant A dies | It does not have flowers for the plant to obtain nectar for nutrients. | |
| Plant B dies | It does not have enough water as most of the roots have been removed. | |
| Plant C dies | It does not have enough food as the fruits have been removed. | |
| Plant D dies | It does not have leaves to make food for the plant. | |

| | |
|-------|---|
| Score | 2 |
|-------|---|

Continue on page 31

Continued from page 30

The diagram shows another plant found in Omar's garden.

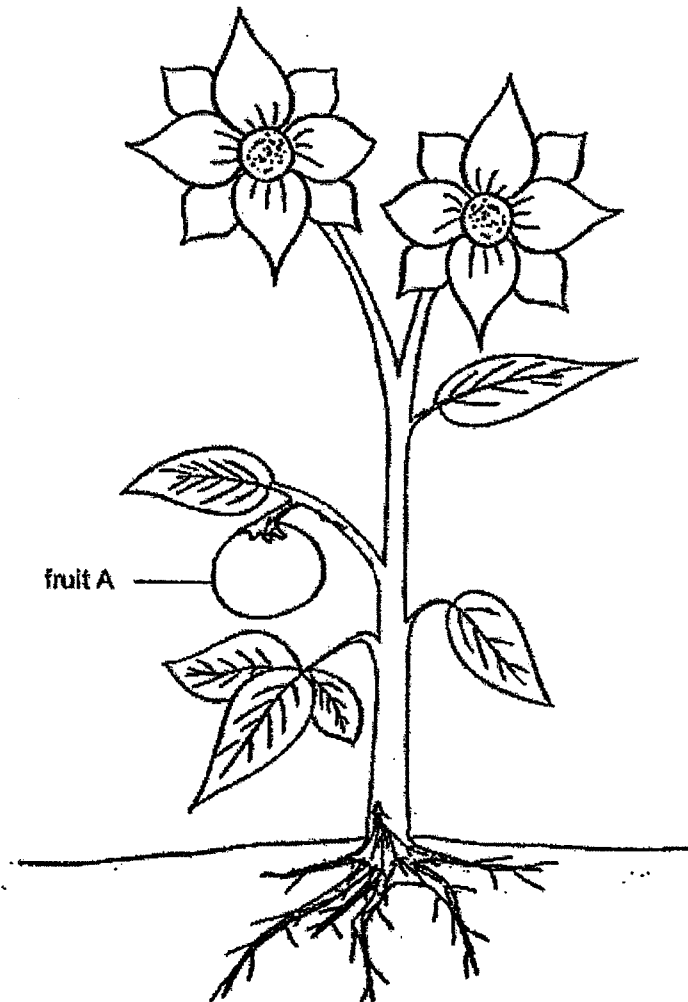

- (b) Draw arrows on the diagram above to show how water is transported to fruit A. [1]

| | |
|-------|---|
| Score | 1 |
|-------|---|

37. Munah conducted an experiment using two similar plants, P and Q, and marked out two similar parts on the stem of each plant as shown in the diagrams.

At the similar part of the stems of plants P and Q, Munah made a cut. The outer layer of the stem at part X of plant P were removed, while half of the stem at part Y of plant Q was removed.

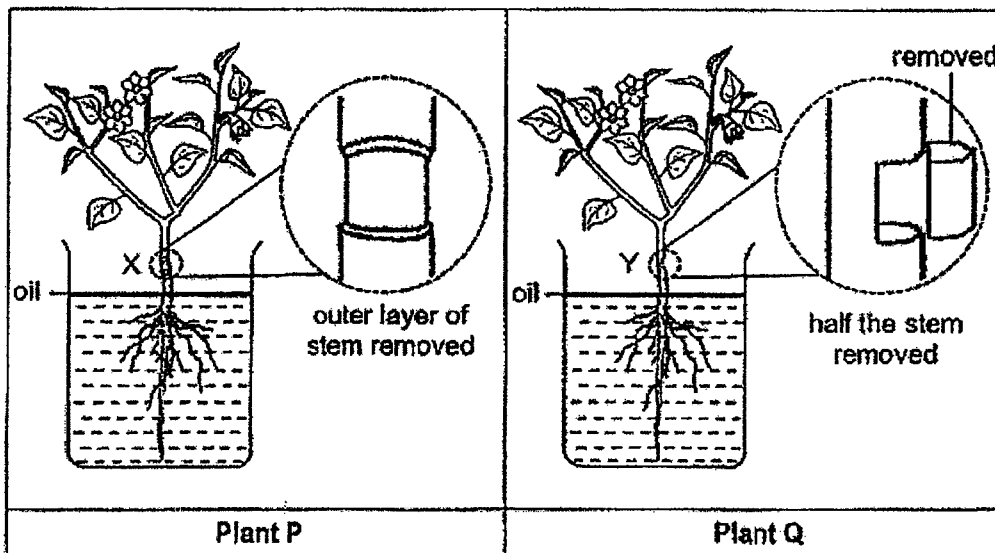

The cross-section of parts X and Y are as shown below.

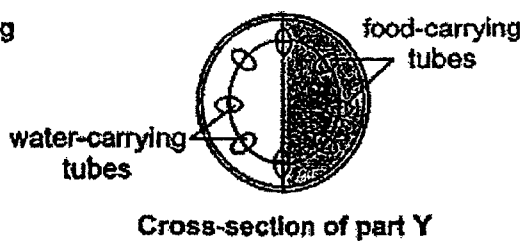
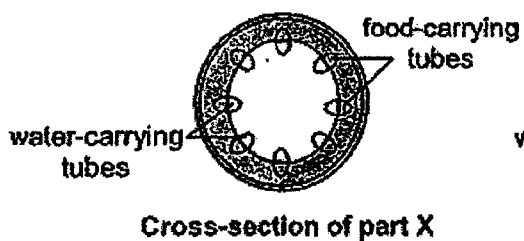
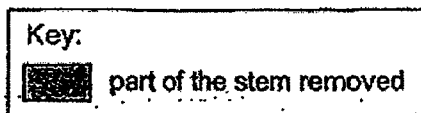

He then placed them each in a beaker filled with water. He measured the amount of water in the beakers for a few days.

Continue on page 33

Continued from page 32

The volume of water in the beakers were recorded over a few days as shown in the graph.

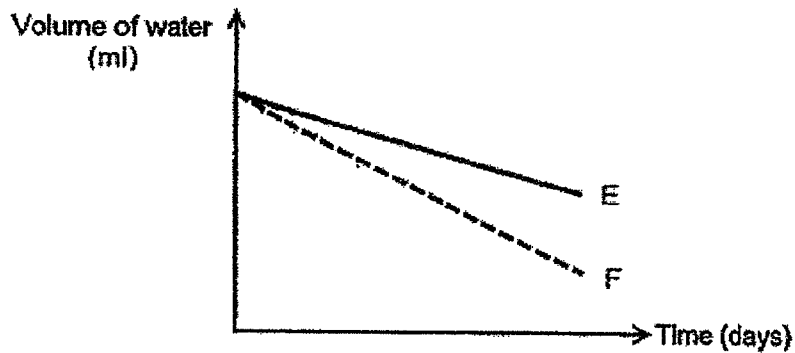

- (a) Which line, E or F, represents the change in volume of water in the beaker containing plant P? Explain your answer. [1]

After some time, one of the plants wilted and died.

- (b) Which plant, P or Q, wilted and died? Explain your answer. [2]

| | |
|-------|---|
| Score | 3 |
|-------|---|

38. The diagram shows a water cycle.

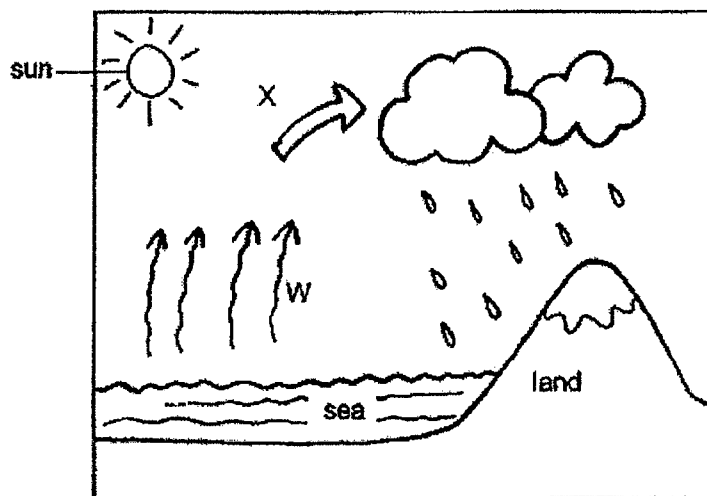

Water cycle

- (a) What processes do arrows W and X represent?

[1]

W: _____

X: _____

Continue on page 35

| | |
|-------|---|
| Score | 1 |
|-------|---|

Continued from page 34

The diagram show set-up R that can be used to obtain pure water from sea water.

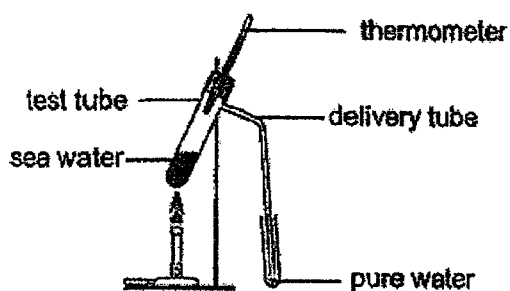

Set-up R

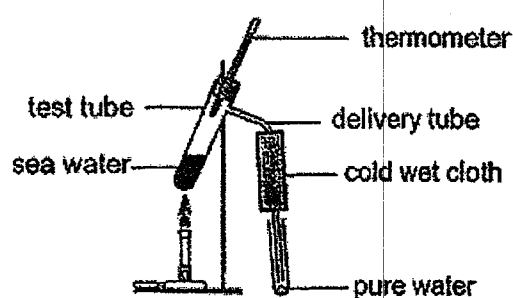

Set-up S

Rahman suggested wrapping the delivery tube with a cold wet cloth, as shown in set-up S, will increase the amount of pure water collected in the test tube over a period of two minutes.

(b) Do you agree with Rahman? Explain your answer.

[2]

The size of the cold wet cloth was changed as shown in set-up T. The temperature of the cold wet cloth remained the same.

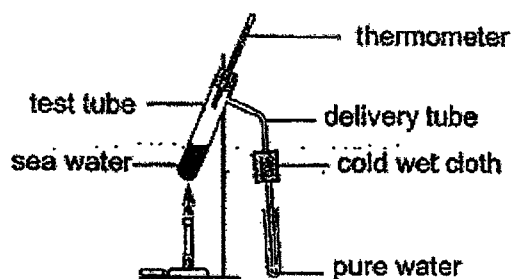

Set-up T

(c) Will the amount of pure water collected in the test tube over a period of two minutes increase, decrease or remain the same as compared to set-up S? Give a reason for your answer.

[2]

| | |
|-------|---|
| Score | 4 |
|-------|---|

- 39 The diagram shows a steel bridge. One end of the bridge was fixed to the structure while the other end was mounted on rollers. The bridge was built this way so that the bridge will not break during a hot day.

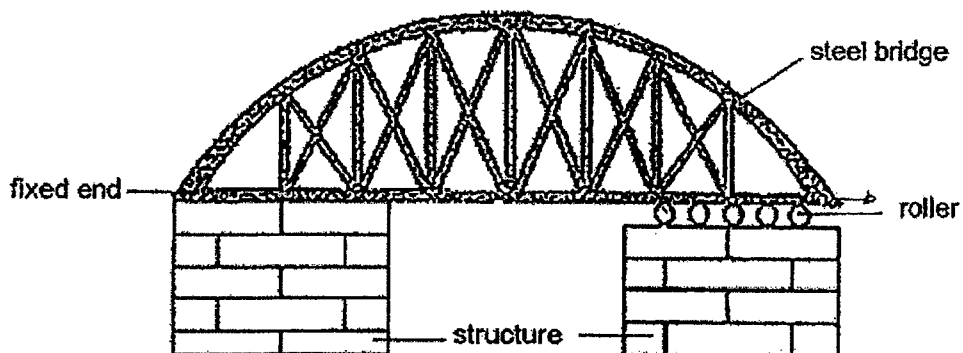

- (a) Explain why one end of the steel bridge was not fixed to the structure? [2]

Continue on page 37

| | |
|-------|---|
| Score | / |
| | 2 |

Continued from page 36

Bricks are used to build walls of houses. The diagram shows two different types of bricks of identical size and material.

hollow spaces filled with air

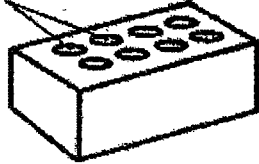

Hollow brick

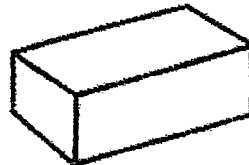

Solid brick

The table shows the temperature of the surrounding air outside the house on a particular day.

| | At 8am | At 12pm |
|---|--------|---------|
| Temperature of surrounding air outside the house ($^{\circ}\text{C}$) | 24 | 36 |

The walls of two identical houses were built using the different types of bricks.

The table records the temperature of air in the houses at 8am and 12pm respectively.

| Type of brick used to make the walls | Temperature of air in the house at 8am ($^{\circ}\text{C}$) | Temperature of air in the house at 12pm ($^{\circ}\text{C}$) |
|--------------------------------------|---|--|
| Hollow brick | 24 | 28 |
| Solid brick | 24 | 34 |

- (b) Using the data from the table, explain how using hollow bricks to build walls of houses helps to keep the house cooler on hot days. [2]

| | |
|-------|---|
| Score | 2 |
|-------|---|

40. The diagram shows a toy car and circuit A which is found in the toy car.

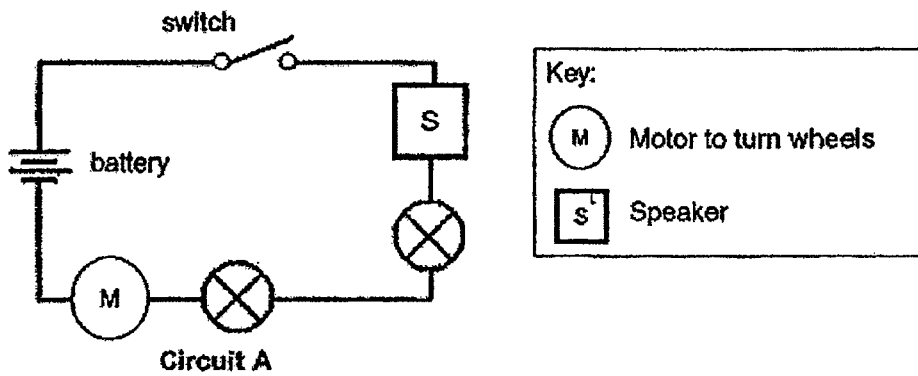
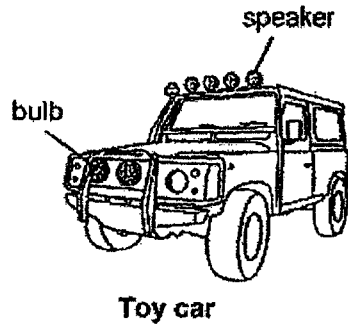

(a) In the box, using the same electrical components in circuit A, draw another circuit diagram that will increase the brightness of each of the bulbs. [2]

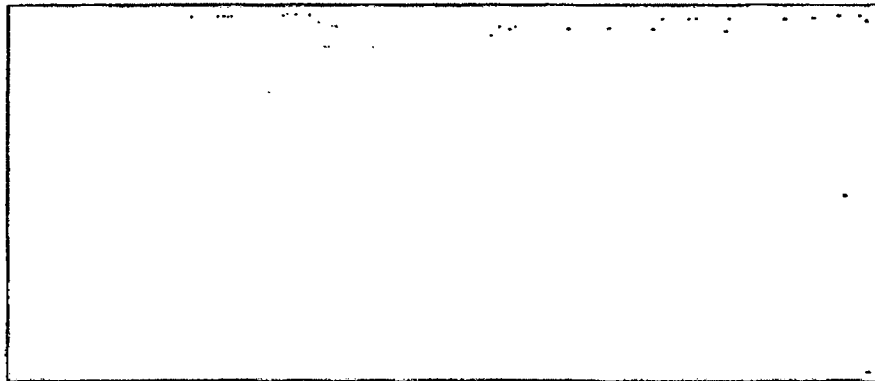

| | |
|-------|---|
| Score | 2 |
|-------|---|

Continue on page 39

Continued from page 38

The same electrical components in the toy car are connected to form circuit B as shown.

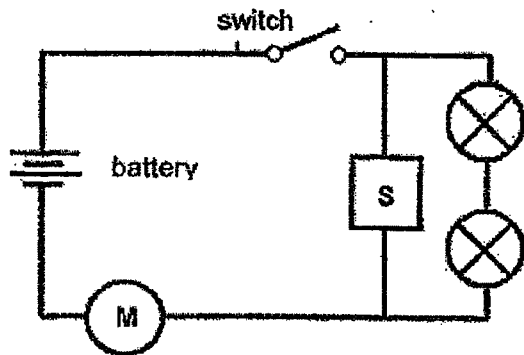

Circuit B

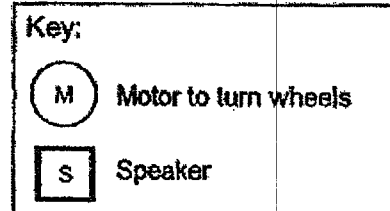

(b) State an advantage of using circuit B.

[1]

Using circuit B, Elijah decided to measure the brightness of the bulbs on the toy car with different number of batteries added to the circuit and record the result in the graph.

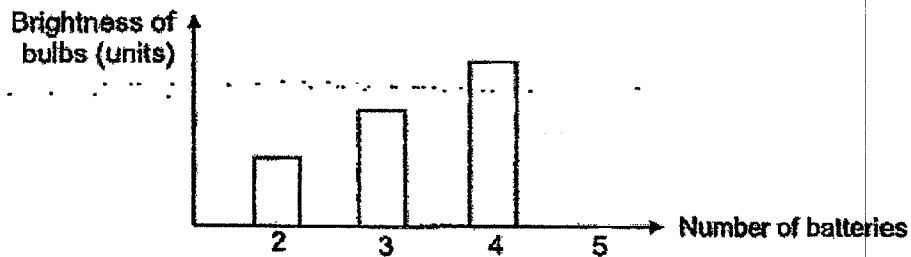

(c) Based on the information above, what happened to the bulb when the 5th battery was added to the circuit. Give a reason for your answer. [1]

| | |
|-------|---|
| Score | 2 |
|-------|---|

41. The diagram shows a teddy bear of mass 30g and a bar magnet of mass 90g on a balance. Object G was placed below the bar magnet. It was observed that the rod was balanced as shown in the diagram.

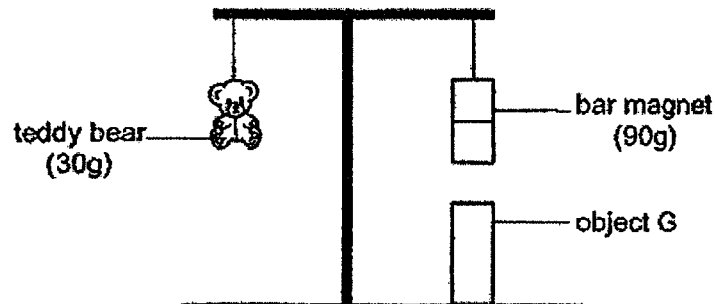

What could object G be? Explain your answer.

[2]

End of Paper

40

| | |
|-------|---|
| Score | 2 |
|-------|---|

P5 Science EYE 2022

SCHOOL : RAFFLES GIRLS' PRIMARY SCHOOL
 LEVEL : PRIMARY 5
 SUBJECT : SCIENCE
 TERM : 2022 END-OF-YEAR

SECTION A

| | | | | | | | | | |
|------|-----|-----|-----|-----|-----|-----|-----|-----|-----|
| Q 1 | Q2 | Q3 | Q4 | Q5 | Q6 | Q7 | Q8 | Q9 | Q10 |
| 3 | 1 | 2 | 2 | 3 | 1 | 4 | 3 | 3 | 4 |
| Q 11 | Q12 | Q13 | Q14 | Q15 | Q16 | Q17 | Q18 | Q19 | Q20 |
| 2 | 4 | 4 | 3 | 4 | 2 | 2 | 4 | 4 | 3 |
| Q 21 | Q22 | Q23 | Q24 | Q25 | Q26 | Q27 | Q28 | | |
| 2 | 4 | 2 | 4 | 2 | 4 | 4 | 2 | | |

SECTION B

| | | | |
|-------|---|-----------------|----------|
| Q29a) | The process shown in the diagrams are fertilisation. | | |
| Q29b) | To increase the chances of the nucleus of the male sex cell (sperm) fusing with the nucleus of the female sex cell (egg). | | |
| Q29c) | Statement | Tick (✓) | |
| | Both the pollen grains and sperms are produced by the females parts. | | |
| | Both the pollen grains and sperms can move from place to place on their own. | | |
| | Both the pollen grains and sperms carry genetic information that can be passed down to their offspring. | ✓ | |
| Q30a) | Method of pollination \ Flower | X | Y |
| | Insect pollinated | | ✓ |
| | Wind pollinated | ✓ | |

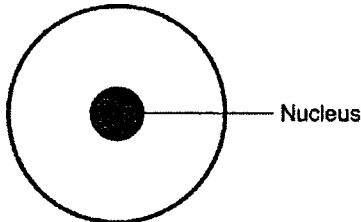
| | |
|-------|---|
| Q30b) | (i) Flower Y has sweet, scented nectar. (ii) Flower Y has bright and colourful petals. |
| Q30c) | Part P will develop into a fruit after fertilisation |
| Q31a) | 10 ml |
| Q31b) | The roots of the plant in Y was not coated with wax and there was a layer of oil on the water. Hence, roots of the plant in Y was able to absorb water, resulting in greater decrease in volume of water than X but less than Z, where there was a greater decrease in water due to evaporation and absorption of water by plant. |
| Q31c) | Test tubes X and Y. |
| Q32a) | As the size of the food increases, the time taken to completely digest the food substance increases. |
| Q32b) | Chewing breaks the food into smaller pieces, increasing the exposed surface area of the food to digestive juices. Hence, the digestive juices can break down the food into simpler substances faster. |
| Q33a) |  |
| Q33b) | Cell L: came from leaves of plant. Reason: has chloroplasts which contain chlorophyll that traps light to make food. Cell M: came from roots of plant. Reason: does not have chloroplasts but has a cell wall. |
| Q33c) | Cell membrane. |
| Q34a) | Human: B Fish: D |
| Q34b) | Water contains dissolved oxygen that enters the fish's mouth. Oxygen is absorbed into the blood as water passes through the gills. |
| Q35a) | Running: AB Brisk walking: BC |

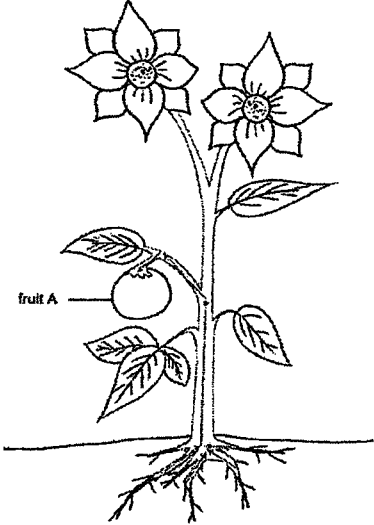
| Q35b) | From C to D, Carine is slowing down. Thus, her heart rate decreases as her heart is pumping oxygenated blood to various parts of the body more slowly to release less energy required by the less intense activity. | | | | | | | | | | |
|--------------|---|-------------|----------|--------------|--|--------------|---|--------------|--|--------------|---|
| Q36a) | <table border="1" data-bbox="392 443 735 712"> <thead> <tr> <th data-bbox="392 443 587 501">Observation</th> <th data-bbox="587 443 735 501">Tick (✓)</th> </tr> </thead> <tbody> <tr> <td data-bbox="392 501 587 548">Plant A dies</td> <td data-bbox="587 501 735 548"></td> </tr> <tr> <td data-bbox="392 548 587 602">Plant B dies</td> <td data-bbox="587 548 735 602">✓</td> </tr> <tr> <td data-bbox="392 602 587 656">Plant C dies</td> <td data-bbox="587 602 735 656"></td> </tr> <tr> <td data-bbox="392 656 587 712">Plant D dies</td> <td data-bbox="587 656 735 712">✓</td> </tr> </tbody> </table> | Observation | Tick (✓) | Plant A dies | | Plant B dies | ✓ | Plant C dies | | Plant D dies | ✓ |
| Observation | Tick (✓) | | | | | | | | | | |
| Plant A dies | | | | | | | | | | | |
| Plant B dies | ✓ | | | | | | | | | | |
| Plant C dies | | | | | | | | | | | |
| Plant D dies | ✓ | | | | | | | | | | |
| Q36b) |  | | | | | | | | | | |
| Q37a) | Line F. All the water carrying tubes in plant P are present. However, half of the water-carrying tubes were removed in B. Hence, P is able to transport more water. | | | | | | | | | | |
| Q37b) | Plant P. All of plant P's for carrying tubes were removed. Food made by the leaves could not be transported to all parts of the plant. The roots will die, thus there will be no roots to take in water and plant cannot make food without water. | | | | | | | | | | |
| Q38a) | W: evaporation X: condensation | | | | | | | | | | |
| Q38b) | Yes, I agree with Rahman. The seawater gains heat and evaporates into water vapour. The warmer water vapour will lose more heat to the cooler part of the delivery tube covered with the cold wet cloth and condense faster. | | | | | | | | | | |

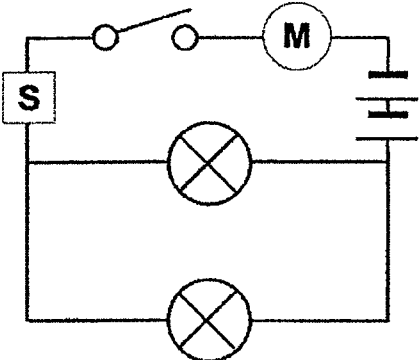
| | |
|-------|---|
| Q38c) | It will decrease. The warmer water vapour is losing less heat to the smaller, cooler surface of the delivery tube covered with the smaller piece of cold, wet cloth. Hence, resulting in a slower rate of condensation. |
| Q39a) | The bridge gains heat and expands on hot days. When bridge expands, the roller allows the bridge to slide and move. This, bridge will not break or collapse. |
| Q39b) | The air in the hollow spaces of the hollow brick is a poor heat conductor. Hence, it conducts heat from the surrounding air outside to the house at a slower rate. |
| Q40a) |  |
| Q40b) | The speaker will be louder in Circuit B than in A. |
| Q40c) | As the electrical current flows through the circuit, the filament of the bulb melted and the bulb fused. This forms an open circuit, preventing current from flowing. |
| Q41) | Object G could be a magnet. The like poles of the bar magnet and object G were facing each other, causing them to repel as like poles of magnets repel each other. |