



MARIS STELLA HIGH SCHOOL (PRIMARY)

End-of-Year Examination

23 October 2023

**SCIENCE
(BOOKLET A)**

Total Time for Booklets A and B: 1 hour 45 min

INSTRUCTIONS TO CANDIDATES

1. Do not turn over this page until you are told to do so.
2. Follow all instructions carefully.
3. Answer all questions.
4. Shade your answers on the Optical Answer Sheet (OAS) provided.

Name: _____ ()

Class: 5 _____

For each question from 1 to 28; four options are given. One of them is the correct answer. Make your choice (1, 2, 3 or 4). Shade the correct oval (1, 2, 3 or 4) on the Optical Answer Sheet (OAS).
 (28 x 2 marks)

1 Study the chart below.

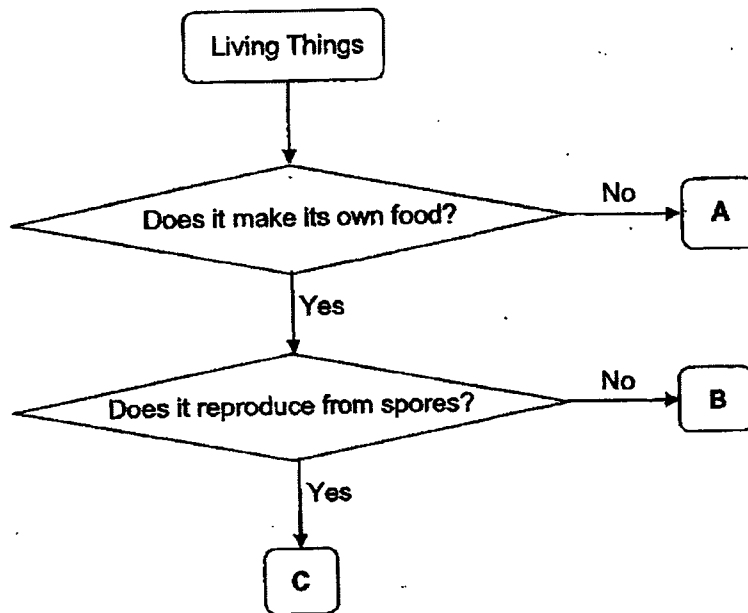

What could A, B and C be?

	A	B	C
(1)	non-flowering plant	flowering plant	fungi
(2)	fungi	flowering plant	non-flowering plant
(3)	flowering plant	non-flowering plant	fungi
(4)	fungi	non-flowering plant	flowering plant

2 Muthu saw an animal in his school garden.
Which of the following questions will help Muthu determine if the animal is an insect?

- (1) Does the animal lay eggs?
- (2) Does the animal have wings?
- (3) Does the animal have three body parts?
- (4) Does the animal have scales as outer covering?

3 Jia Min placed some bacteria in dish X.

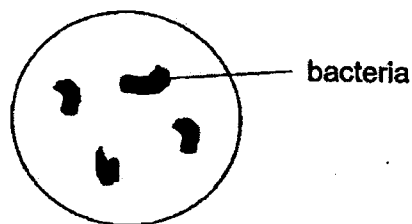

Dish X

She counted the amount of bacteria in the dish at the start and 6 hours after the experiment. The table below shows her results.

Amount of bacteria at the start	Amount of bacteria after 6 hours
100	250

Which of the following can Jia Min conclude from her experiment?

- (1) Living things grow.
- (2) Living things reproduce.
- (3) Living things respond to changes.
- (4) Living things need air, food and water to survive.

- 4 The diagram below shows the life cycle of animal P.

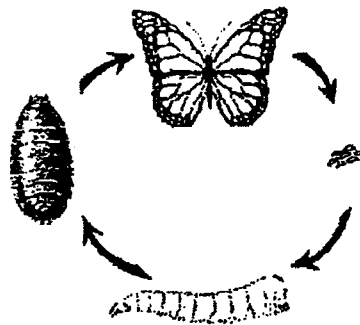

In a farm growing fruit tree X, the farmer discovered that the leaves of fruit tree X were being eaten by the young of P. He then sprayed insecticide on the leaves of fruit tree X to get rid of the young of P.

Which of the following is a likely result of spraying?

- (1) More fruits formed.
 - (2) Fewer fruits were formed.
 - (3) Fewer flowers were formed.
 - (4) Fewer leaves were on the trees.
- 5 Cells A, B and C are taken from different plants and animals. The table shows some of the cell parts of the three cells.

cell part	A	B	C
cell wall	✓	✓	
nucleus	✓	✓	✓
chloroplasts	✓		

Which statement is correct?

- (1) Cells A and B are taken from plants.
- (2) Cells B and C are taken from animals.
- (3) The organism cell C is taken from does not need food.
- (4) The organism cell B is taken from cannot make its own food.

6 Which of the following are the basic unit of life for a plant and human?

	plant	human
(1)	pollen grain	cell
(2)	cell	cell
(3)	ovule	egg
(4)	cell	sperm

7 Which of the following shows the correct order of the four processes in the reproductive cycle of flowering plants?

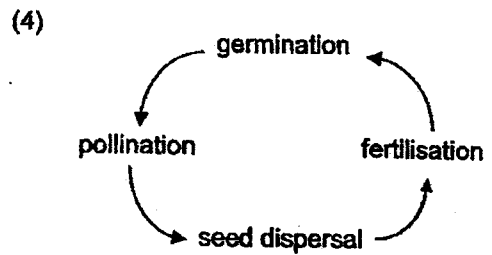
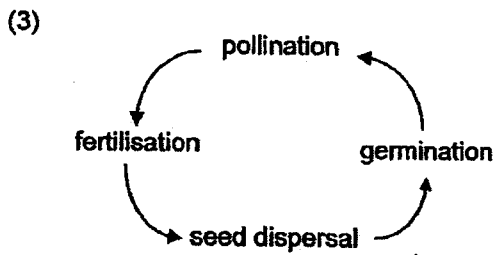
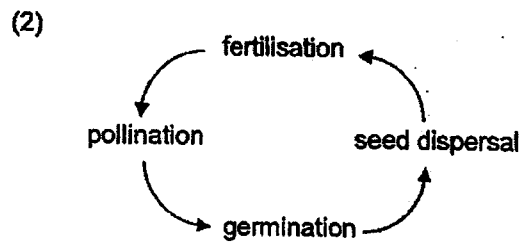
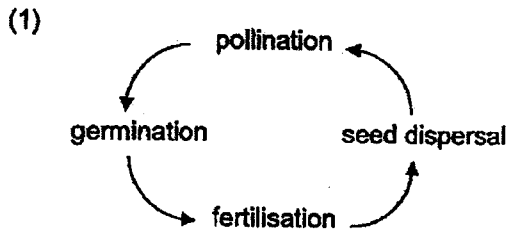

8 Food made in the leaves is stored as starch in the leaves.

Raj placed a pot of plant P in a dark cupboard for 48 hours to remove all the starch in the leaves. After 48 hours, he clipped two pieces of black paper to a leaf on Plant P as shown.

The pot of plant was then left in the sun for 12 hours.

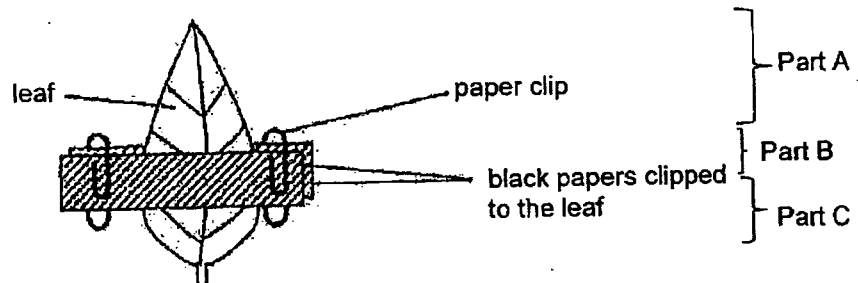

Raj tested the leaf for the presence of starch after leaving the pot of plant in the sun for 12 hours.

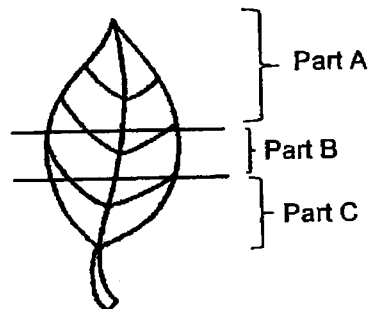

Which part(s) of the leaf contained starch?

- (1) Part B only
- (2) Part C only
- (3) Parts A and C only
- (4) Parts A, B and C

- 9 The graph below shows the amount of digested food in some organs of Ken's digestive system before the digested food was absorbed into the blood.

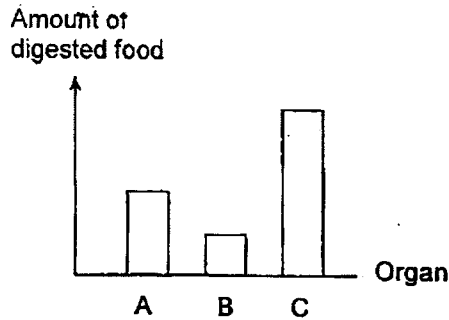

Which of the following correctly identifies organs A, B and C?

	A	B	C
(1)	stomach	large intestine	small intestine
(2)	stomach	mouth	small intestine
(3)	large intestine	gullet	mouth
(4)	small intestine	mouth	stomach

- 10 Study the diagram below.

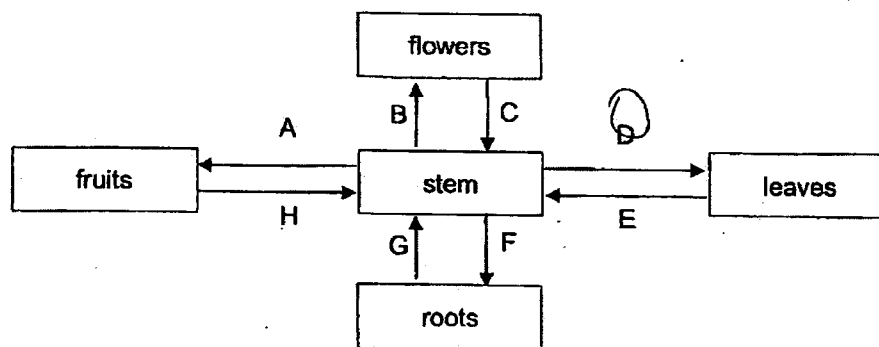

Which arrows show the correct direction in which water moves in a plant?

- (1) A, B, D and G
- (2) A, B, E, and F
- (3) A, C, D and G
- (4) C, E, F and H

11 Jason wrote some statements about humans, fish and plants.

Which statement is correct?

- (1) Humans, fish and plants only take in oxygen.
- (2) Plants transport food and water in the same tube.
- (3) Gaseous exchange takes place at the gills and nose.
- (4) Oxygen and carbon dioxide are transported by the blood in humans and fish.

12 Which of the following correctly shows the pathway of carbon dioxide from the leg to out of the human body?

- (1) leg → heart → windpipe → lungs → nose
- (2) leg → heart → lungs → windpipe → nose
- (3) leg → lungs → heart → windpipe → nose
- (4) leg → windpipe → lungs → heart → nose

13 Which of the line graph below is likely to represent a fruit that is sweet and fleshy?

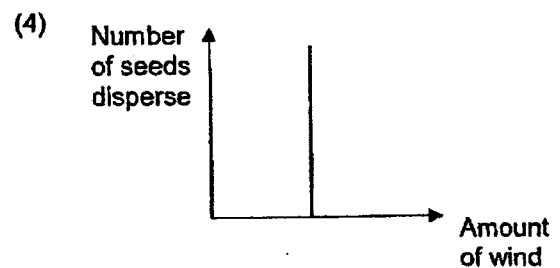
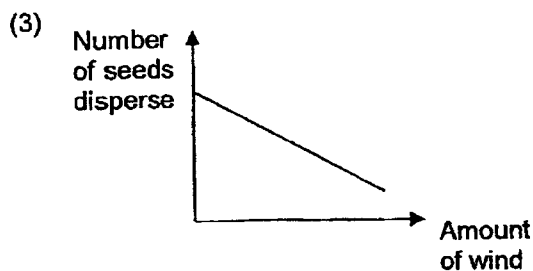
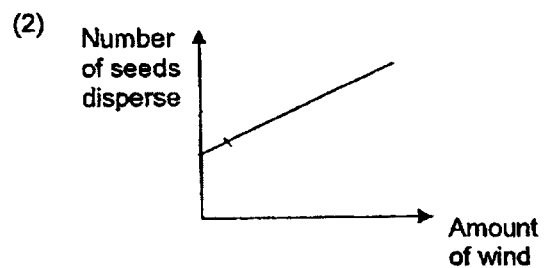
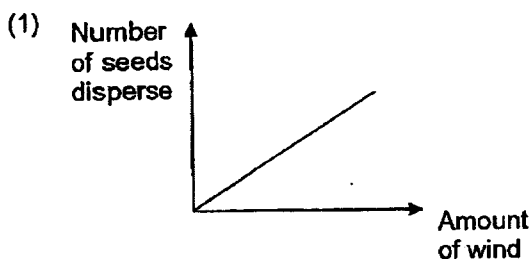

- 14 Diagram A shows the distribution pattern of plants X, Y and Z on an island.
Diagram B shows the distribution pattern 5 years later.

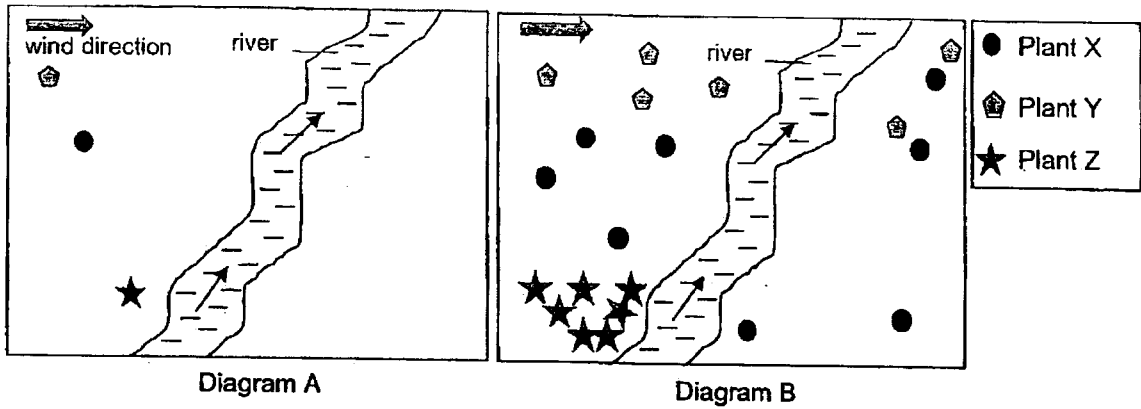

Based on observations, which of the following statement(s) about the fruits of plants X, Y and Z is/are possibly correct?

- P The fruit of plant X has small stiff hooks.
 - Q The fruit of plant Y has a waterproof outer covering.
 - R The fruit of plant Z splits open when it is dry and ripe.
- (1) R only
 - (2) P and Q only
 - (3) P and R only
 - (4) P, Q and R

- 15 The diagram below shows a frog that feeds on the nectar of the flower of Tree A. Their long and thin bodies allow them to squeeze into the flowers to get the nectar for food.

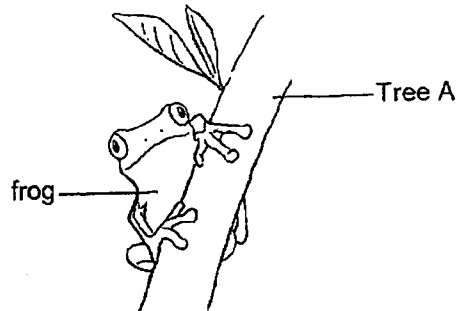

Based on the information above, how does the frog help Tree A?

- (1) The frog helps to disperse Tree A's seeds.
 - (2) The frog helps to pollinate Tree A's flowers.
 - (3) The frog helps in transfer nectar to another plant.
 - (4) The frog's droppings provide nutrients for Tree A's flowers.
- 16 The diagram below shows the female reproductive system in humans.

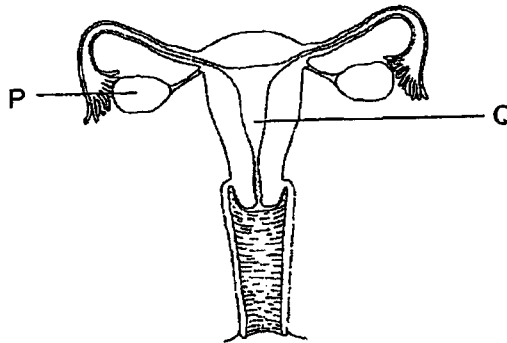

Which of the following statements is true?

- (1) Q produces sperms.
- (2) P stores fertilised eggs.
- (3) Q is where the fertilised egg develops.
- (4) P is where the fertilised eggs are produced.

- 17 Patrick inflated an inflatable pool, filled it with water and placed in his garden for his child to play.



The material used to make the inflatable pool must be _____.

- (1) waterproof and strong
- (2) transparent and strong
- (3) flexible and can float on water
- (4) waterproof and can float on water

- 18 Janet is in a mirror maze.

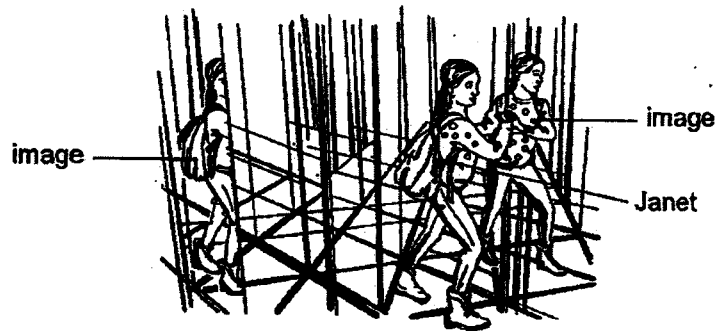

Which statement explains why Janet sees more than one image of herself?

- (1) The mirrors allow light to pass through.
- (2) The mirrors do not allow light to pass through.
- (3) The mirrors reflected light from Janet into her eyes.
- (4) The mirrors gave off light which travelled into Janet's eyes.

- 19 Isaac walked barefooted on some ceramic tiles and then on the wood flooring in a room. The room temperature is 28 °C.

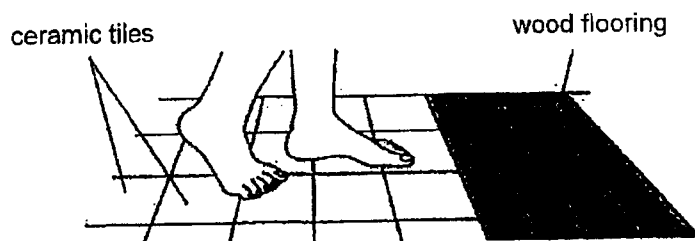

His feet felt cold on the ceramic tiles but not on the wood flooring.

Which of the following statements most likely explains why?

- (1) The wood flooring transferred more heat to his feet.
- (2) The temperature of the ceramic tiles is less than 28°C.
- (3) The temperature of the wooden flooring is higher than his feet.
- (4) The ceramic tile is a better conductor of heat than the wood flooring.

- 20 The diagram below shows two ring magnets when left untouched.

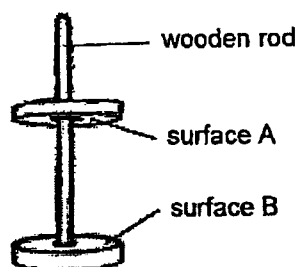

Which of the following states the poles at surfaces A and B with the correct explanation?

	Surface A	Surface B	Explanation
(1)	north	south	Unlike poles of the magnets face each other and attract.
(2)	south	north	A freely suspended magnet rest in the north-south direction.
(3)	north	north	Like poles of the magnets face each other and repel.
(4)	south	south	Surface A is made of a magnetic material.

- 21 Vijay rolled an iron ball from Point A at a low speed past a strong magnet placed on a horizontal flat table top as shown.

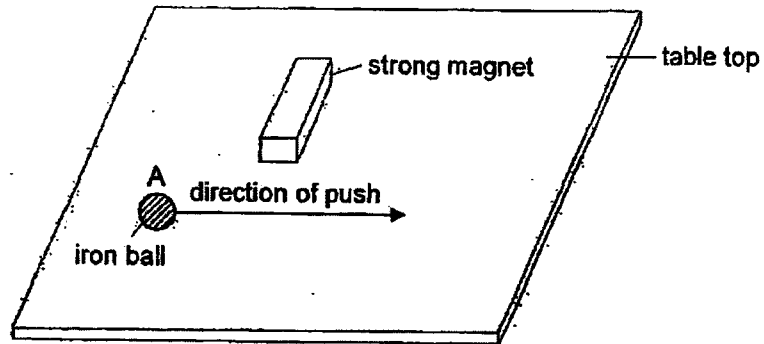

Which of the following correctly shows the path taken by the iron ball?

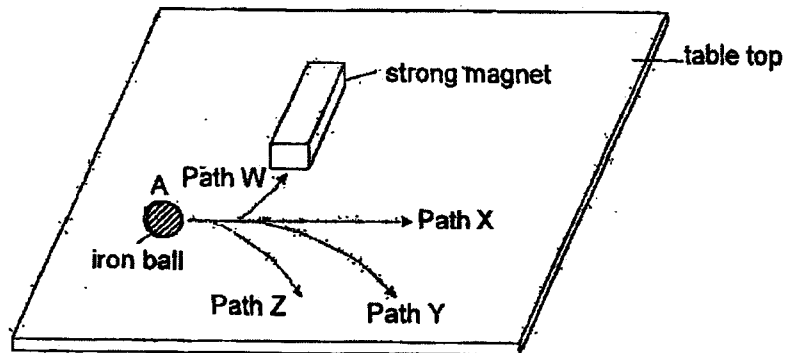

- (1) Path W
- (2) Path X
- (3) Path Y
- (4) Path Z

- 22 X and Y are similar beakers that contain the same amount of hot water at the same temperature. Equal amounts of ice are placed in the beakers.

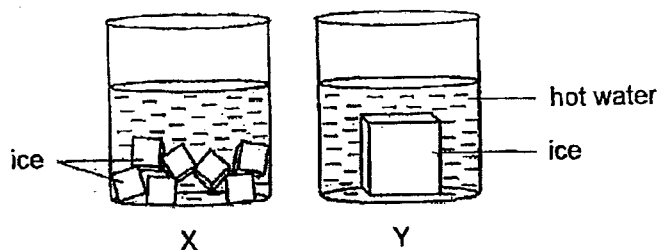

Which of the following statements is correct?

- (1) The ice in X takes a shorter time to melt because it has a smaller volume.
 - (2) The ice in Y takes a shorter time to melt because it has a smaller volume.
 - (3) The ice in Y takes a longer time to melt because it has a larger exposed surface area.
 - (4) The ice in Y takes a longer time to melt because it has a smaller exposed surface area.
- 23 Limin placed a beaker of cold water at 5 °C on an electronic balance. The reading on the electronic balance at the start of the experiment is as shown.

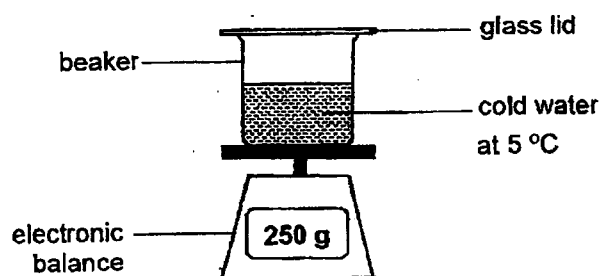

After 10 minutes, which of the following is correct?

	Reading on electronic balance	Explanation
(1)	249 g	The water in the beaker evaporated.
(2)	250 g	The water in the beaker cannot evaporate.
(3)	251 g	Condensation occurred on the under surface of the glass lid.
(4)	251 g	Condensation occurred on the outer surface of the beaker.

- 24 The table below shows the freezing and boiling point of three substances, P, Q and R.

substance	freezing point (°C)	boiling point (°C)
P	4	99
Q	28	66
R	59	210

At which temperature are all three substances in the liquid state?

- (1) 0 °C
- (2) 36 °C
- (3) 60 °C
- (4) 200 °C

- 25 Travis placed some ice cubes in a glass and left the glass on the kitchen table.

Which of the following graphs shows the changes in the temperature of the ice cubes over 1 hour?

(1)

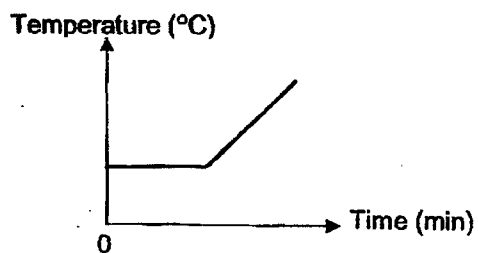

(2)

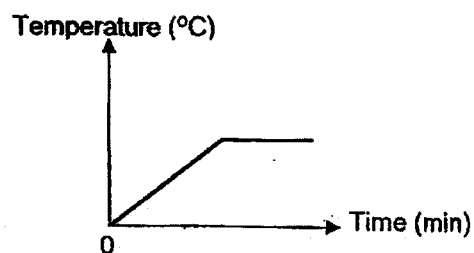

(3)

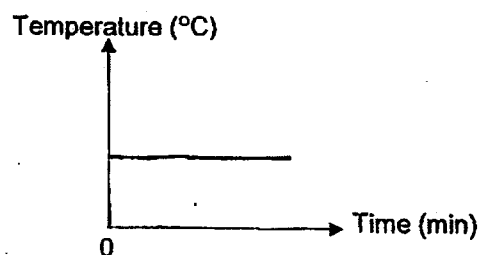

(4)

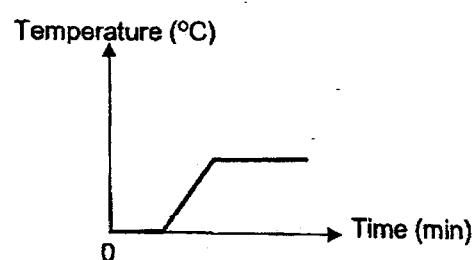

26 Greg heated three identical beakers of water, X, Y and Z, over a flame until they boiled.

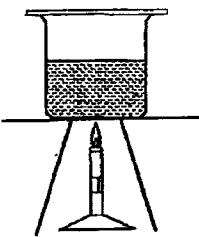
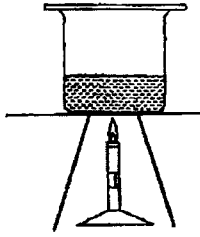
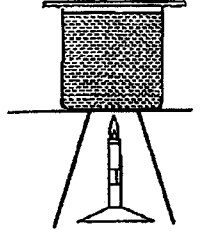
	Beaker X	Beaker Y	Beaker Z
			
Amount of water in beaker (ml)	500	250	900
Starting temperature of water in beaker (°C)	90	90	60

Which of the following statements are true?

- A The water in X boiled first.
- B The water in Z had to gain the most heat to boil.
- C During boiling, the water in all three set-ups have a temperature of 100 °C.
- D The water in Y had more heat than the water in Z when the water boiled.

- (1) A and B only
- (2) A and C only
- (3) B and C only
- (4) C and D only

27 Peter set up the following circuit.

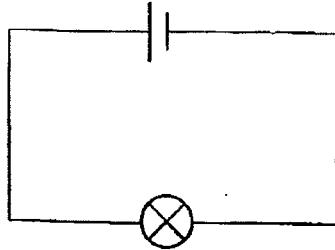

He increased the number of batteries connected in series in the circuit one at a time and measured the brightness of the bulb using a data logger. The graph below shows his results.

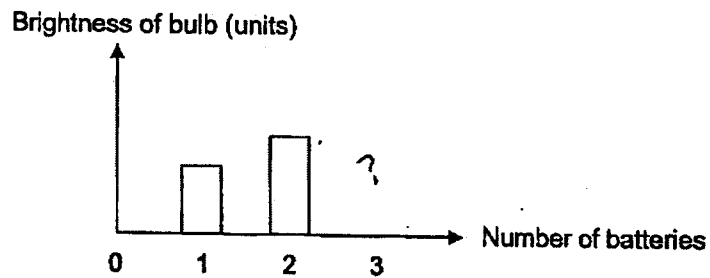

Which of the following explains Peter's results when 3 batteries were used?

- (1) The bulb has fused.
- (2) The wires were faulty.
- (3) The batteries were out of energy.
- (4) There was too little electric current flowing through the circuit.

28 Study the diagram below.

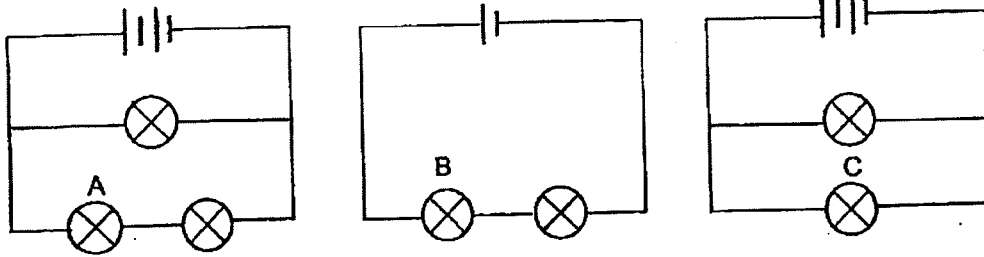

Which of the following correctly shows the brightness of the bulbs?

Brightness of bulb			
	high	medium	low
(1)	A	C	B
(2)	B	A	C
(3)	C	A	B
(4)	B	C	A



MARIS STELLA HIGH SCHOOL (PRIMARY)

End-of-Year Examination

23 Oct 2023

**SCIENCE
(BOOKLET B)**

Total Time for Booklets A and B: 1 hour 45 minutes

INSTRUCTIONS TO CANDIDATES

1. Do not turn over this page until you are told to do so.
2. Follow all instructions carefully.
3. Answer all questions.
4. Use a dark blue or black ballpoint pen to write your answers in the space provided for each question.
5. Do not use correction fluid/tape or highlighters.

Booklet A: _____ / 56
Booklet B: _____ / 44
Grand Total: _____ / 100

Name: _____ ()
Class: 5 _____

Parent's signature: _____

For questions 29 to 41, write your answers in this booklet. The number of marks available is shown in brackets [] at the end of each question or part question. (44 marks)

29 The diagram below shows part of rose plant A.

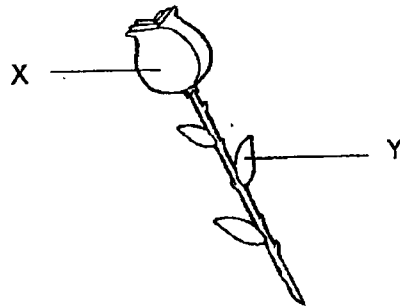

(a) Name a cell part that is present in Y but not in X. [1]

(b) Rose plant A produces bright-coloured flowers but the plant is not resistant to pests. Another type of rose plant, rose plant B, produces dull-coloured roses but the plant is resistant to pests.

Pollinating rose plant A with rose plant B can possibly produce rose plants that produce bright coloured flowers that are resistant to pests. Explain why. [1]

(c) Name the cell part that is responsible for the pest resistant characteristic. [1]

	3
--	---

30 Ahmad placed two white flowers in a beaker of red-coloured water.

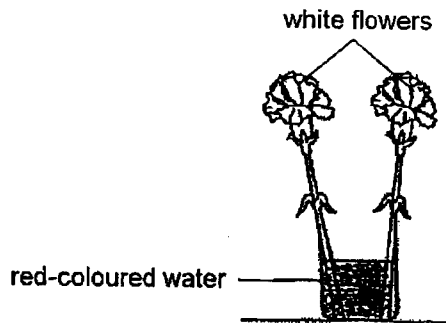

(a) After a day, the flowers turned red. Explain why. [1]

(b) State how flowers are beneficial to plants. [1]

- 31 Many tiny openings are found on the underside of the leaves of plant P. The diagram below shows a leaf of plant P.

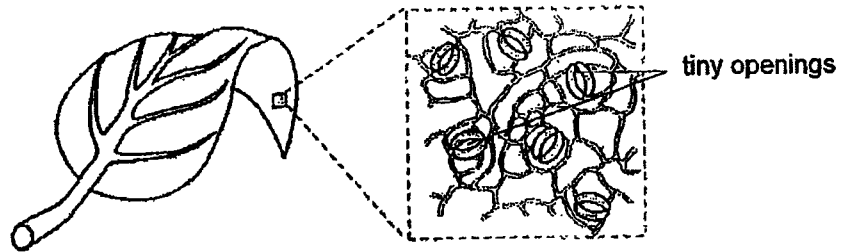

- (a) Why is it important to the plant for the tiny openings to be open during the day? [1]

- (b) Two substances are made in the leaves during the day.
Besides food, identify the other substance made and describe what happens to it. [2]

- (c) Dominic wants to find out if temperature affects the number of tiny openings on leaves of plant P. He placed three identical pots of plant P in three locations of different temperatures. After a few days, he recorded his results.

State what Dominic should measure from the three pots of plant to obtain his result. [1]



- 32 (a) State three conditions which are necessary for seeds to become seedlings. [1]
-

- (b) Xinyi wants to investigate if placing eggshells in the soil speeds up the growth of plant X. She only has the items listed below. She may use some or all of them.

Item	Quantity
moist soil	800 g
crushed eggshells	30 g
seeds of plant X	12 pieces

Xinyi used two identical clear containers for her investigation.

What item(s) and quantity should she put inside the container for each set-up? [2]

Experimental set-up:

Control set-up:



- 33 The leaf shown below is green and white in colour. Fabian cut out circular discs of equal size from different parts of the leaf. The leaf discs can still carry out their functions as a leaf for some time.

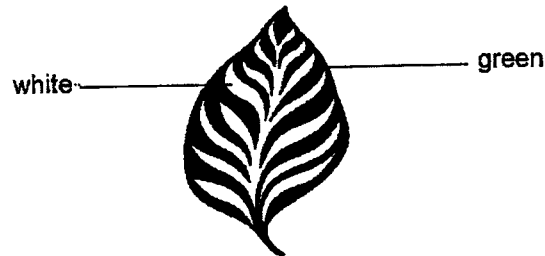

Fabian placed five green and five white leaf discs into a clear container with water.

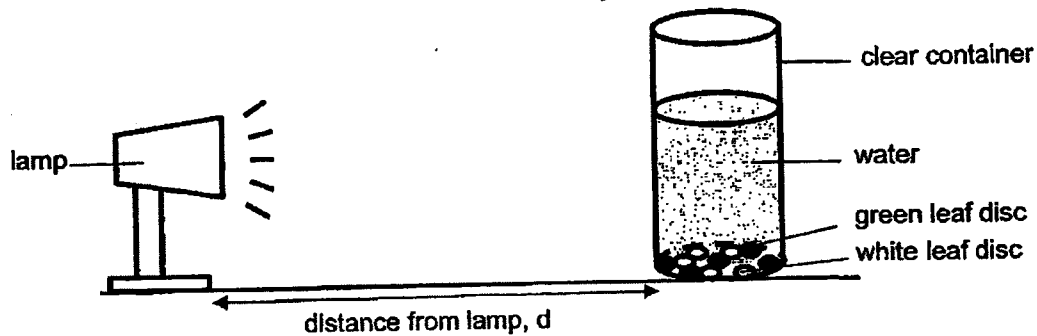

After some time, bubbles were observed under the green leaf discs and the green leaf discs floated up to the surface of the water. The white leaf discs remained at the bottom of the glass container.

- (a) Name the process that occurred in the green leaf discs to cause them to float up to the surface of the water. [1]

- (b) Explain why the white leaf discs did not float up to the surface of the water. [1]

- (c) Suggest why Fabian used five of each of the coloured leaf discs instead of one each. [1]

	3
--	---

- (d) Fabian changed the distance of the clear container from the lamp and repeated the experiment. He recorded the time taken for the first leaf disc to float to the surface of the water. His results are shown in the table below.

Distance of container from lamp (cm)	Time taken for first leaf disc to float (s)
5	9
10	9
15	19
20	27
25	40

State the relationship between the amount of light the leaf discs received and the time taken for the first leaf disc to float to the surface of the water. [2]

	2
--	---

34 The chart below shows how substances P and Q are transported in the human body.

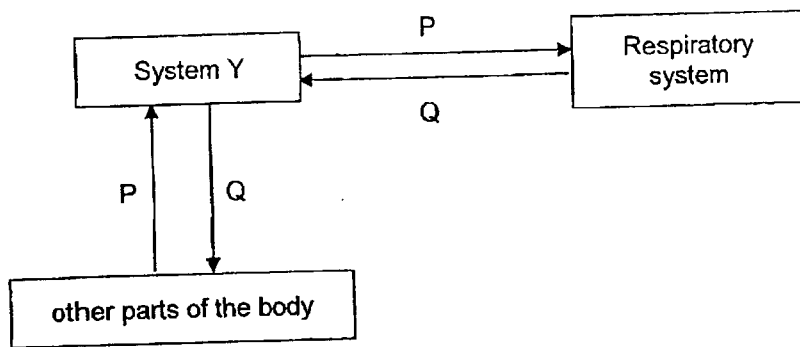

(a) Identify system Y in the chart and state its function [2]

(b) Identify substances P and Q. [1]

P: _____

Q: _____

(c) Describe how substance Q moves from the respiratory system to other parts of the body. [1]

	4
--	---

35 (a) State one difference between inhaled and exhaled air.

[1]

(b) Charlie conducted an experiment to find out how his heart rate is affected during exercise.

(i) State a possible hypothesis on how exercising affects Charlie's heart rate.

[1]

(ii) Charlie's heart rate decreased when he stopped exercising. Explain why.

[2]

	4
--	---

36

Devi used two different types of cups, A and B, for cup stacking. Both types of cups are identical except that cup A has a hole at the bottom but cup B does not.

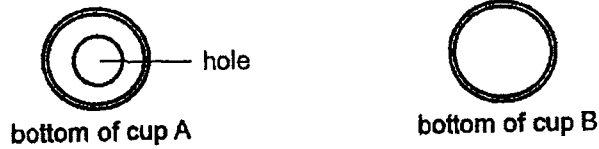

In the game of cup stacking, cups stacked in a pyramid shape, arrangement 1, is rearranged to a tower shape, arrangement 2. Devi used cups A and B separately for stacking. The diagram below shows the height of the cups after stacking.

Cups stacked using cup A

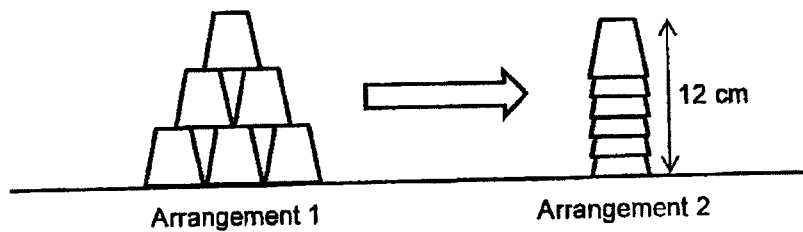

Cups stacked using cup B

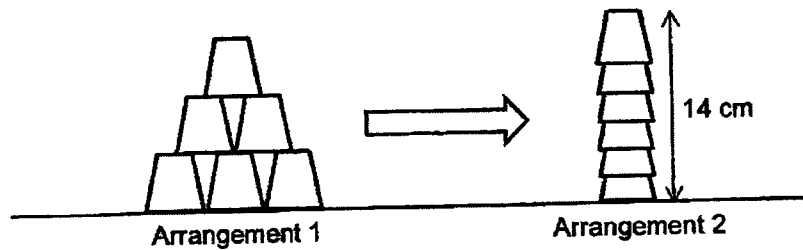

Explain why the cups stacked higher in arrangement 2 when cup B was used. [2]

	2
--	---

37 A container is made of material M.

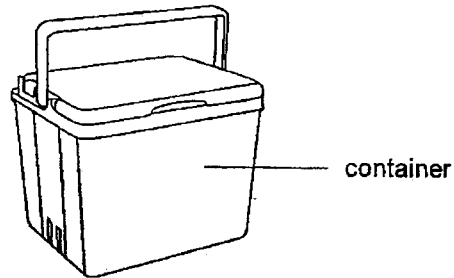

Mrs Chen used the container to bring ice cubes for a picnic.

(a) Explain how material M helped keep the ice from melting.

[2]

(b) When Mrs Chen opened the container, some ice had turned into water.
What was the temperature of the ice-water mixture?

- 38 Xiao Ming filled two identical basins with water and placed them in a windy area in the garden. He covered one of the basins with a plastic container as shown.

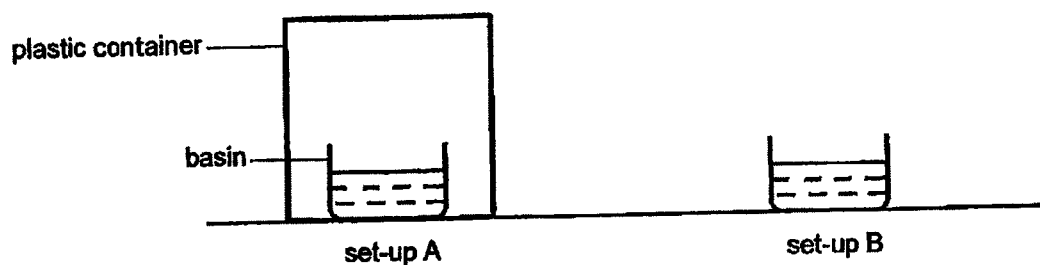

Xiao Ming measured the volume of water in each set-up after a day.

- (a) State the aim of Xiao Ming's experiment.

[1]

- (b) Xiao Ming conducted a fair test. The table below shows an incomplete table of his results. Fill in the missing value in the table.

[1]

Set-up	Volume of water (ml)	
	At the start	After 1 day
A	(b)	498
B	500	480



Xiao Ming noticed that the inner surface of the plastic container was wet after a day.

(c) Explain how the plastic container became wet. [2]

(d) Why must both set-ups be placed in the same location? [1]

	3
--	---

- 39 Jane placed a balloon over the opening of a glass bottle and pushed the balloon into the bottle. The glass bottle was then placed into a basin of cold water. After 5 minutes, Jane observed that the balloon in the bottle became bigger.

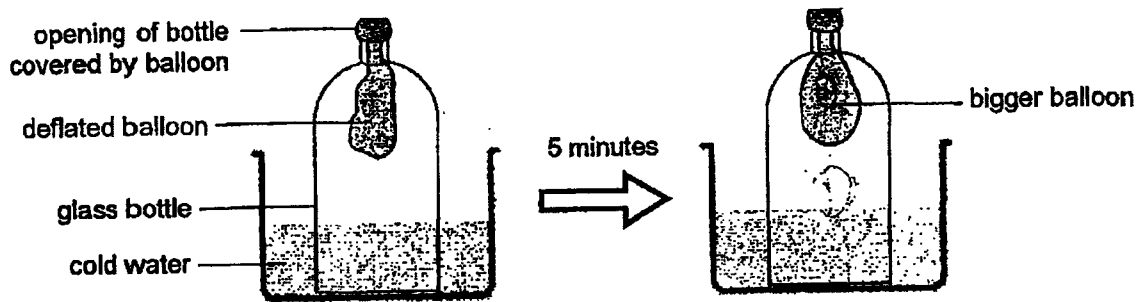

- (a) Explain why the balloon became bigger. [2]

- (b) Jane replaced the glass bottle with a similar-sized metal bottle. She observed that the balloon became bigger faster. Explain why. [2]

- 40 Edith has a toy train operated by batteries. Switches X and Y control the movement, lights and sound of the toy train.

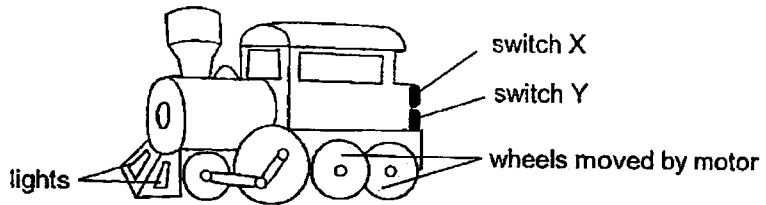

The table below shows the observations made when switches X and Y are closed.

Switch closed	Observations
X only	<ul style="list-style-type: none"> • train moves • lights turned on • speaker plays music
Y only	<ul style="list-style-type: none"> • train moves • lights turned on • speaker does not play music
X and Y	<ul style="list-style-type: none"> • train moves • lights turned on • speaker plays music

The diagram below shows part of the electrical circuit in the toy train. Complete the circuit so that it works as described. The circuit must include switches X and Y. Label switches X and Y. [3]

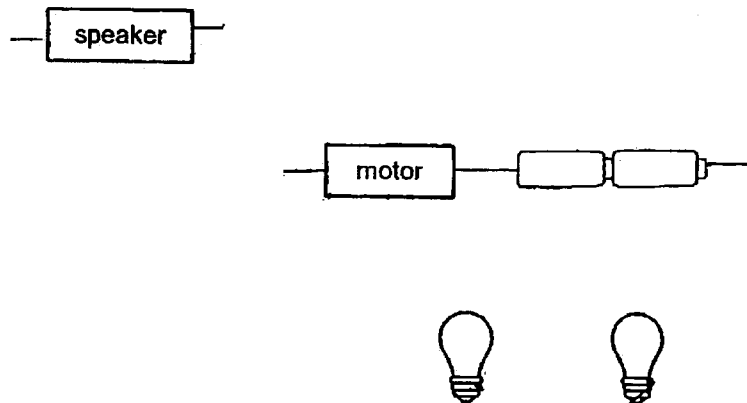

	3
--	---

- 41 The diagram below shows a fish feeder used in a fish farm. When switch S is closed, the cover for the food container slides open to release the fish food into the pond.

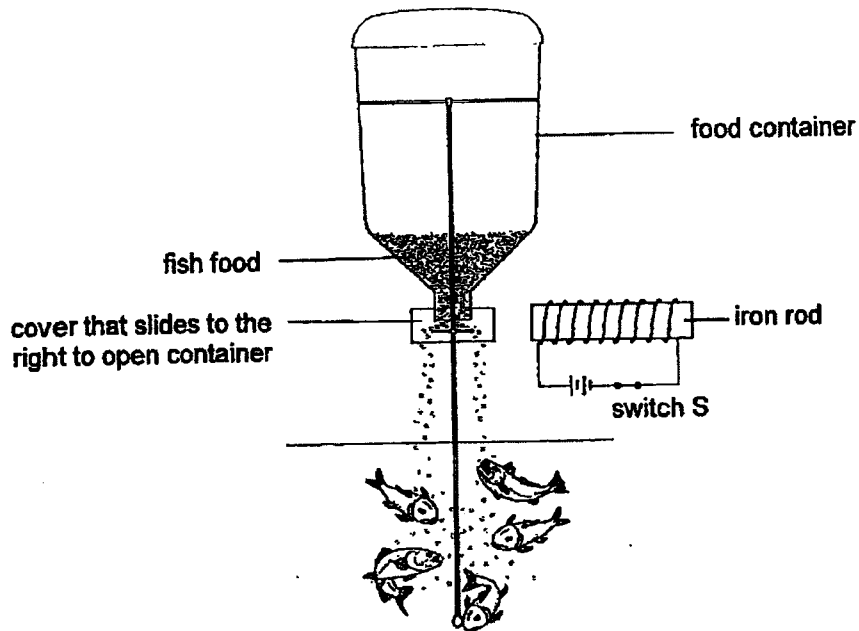

- (a) State a property of the cover of the food container that allows the fish feeder to work. [1]

- (b) Explain how the cover slides open when switch S is closed. [1]

End of Paper

	2
--	---

SCHOOL : MARIS STELLA HIGH SCHOOL
LEVEL : PRIMARY 5
SUBJECT : SCIENCE
TERM : 2023 SA2

CONTACT :

SECTION A

Q1	Q2	Q3	Q4	Q5	Q6	Q7	Q8	Q9	Q10
2	3	2	2	4	2	3	3	2	1
Q11	Q12	Q13	Q14	Q15	Q16	Q17	Q18	Q19	Q20
4	2	4	3	2	3	1	3	4	3
Q21	Q22	Q23	Q24	Q25	Q26	Q27	Q28		
1	4	4	3	4	3	1	3		

SECTION B

Q29a	Chloroplast
Q29b	The rose plants could inherit both of its parents' genetic information.
Q29c	Nucleus
Q30a	The roots of the plant took in the red-coloured water and transported it via the xylem to all parts of the plant including the flower.
Q30b	After fertilisation and pollination, the flower develops into a fruit to help the plant reproduce.
Q31a	The tiny openings take in carbon dioxide to allow the plant to carry out photosynthesis.
Q31b	Oxygen is made. After oxygen is made, it is released by the leaves into surrounding air.
Q31c	He should measure the change in oxygen levels at the three locations.
Q32a	Warmth, oxygen, water
Q32b	Experimental set-up: 400g moist soil, 6 seeds of plant X, 30g crushed eggshells Control set-up: 400g moist soil, 6 seeds of plant X
Q33a	Photosynthesis
Q33b	The white leaf discs did not have chloroplasts and could not carry out photosynthesis to produce oxygen bubbles which would allow the leaf disc to float to the surface.

Q33c	To ensure reliable results.
Q33d	The more the amount of light received by the leaf discs, the faster the time taken for the first leaf disc to float to the surface of the water. For distance of container lower than 10cm, the time taken remains constant even though amount of light received increases.
Q34a	Circulatory system. It transports digested food, oxygen, water and mineral salts to all parts of the body and transports carbon dioxide and other waste materials from all parts of the body to the organs that remove these substances.
Q34b	P: carbon dioxide Q: oxygen
Q34c	From the air sacs in the lungs, the oxygen get absorbed into the bloodstream. Blood in the circulatory system carries the oxygen-rich blood to all parts of the body.
Q35a	There is more oxygen in inhaled air than exhaled air.
Q35bi	When exercising, Charlie's heart rate increases.
Q35bii	When Charlie stopped exercising, his body needs less energy than before. Hence, his heart rate decreases to transport less digested food and oxygen to his body and transports less carbon dioxide produced, for removal.
Q36	As there was no hole in the bottom of cup B, air occupied space and was unable to escape, so the cups were stacked higher.
Q37a	Material M is a poor conductor of heat and heat will take longer to enter the container, thus keeping the temperature low and slowing the melting of the ice.
Q37b	0°C
Q38a	To find out if the presence of wind affects the rate of evaporation.
Q38b	500 ml
Q38c	The water in A gained heat and evaporated into water vapour. The warmer water vapour came into contact with the cooler inner surface of the plastic container and condensed, forming water droplets. Hence, the plastic container became wet.
Q38d	It is to keep all other variables constant and ensure that any difference in results of the experiment is only due to the presence of wind.
Q39a	As the glass bottle loses heat to the cold water, the air in the glass bottle will lose heat to the glass bottle. This causes air in the bottle to contract, decreasing its volume thus there is more space for the balloon to inflate.
Q39b	As metal is a better conductor of heat, heat travels through faster, causing the air in the bottle to lose heat faster, contracting faster to create the space for the balloon to inflate faster.

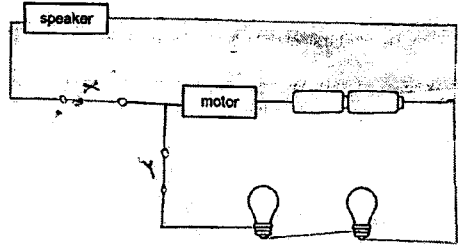
<p>Q40</p>	
<p>Q41a</p>	<p>It is a magnetic material.</p>
<p>Q41b</p>	<p>When the circuit is closed, electricity flows through and makes the iron rod a temporary magnet. Then the iron rod attracts the cover and pulls it to the right, allowing the fish food to drop.</p>

