

SA1

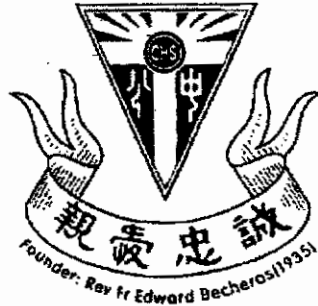

CATHOLIC HIGH SCHOOL
MID-YEAR EXAMINATION (2021)
PRIMARY SIX
MATHEMATICS
PAPER 1
(BOOKLET A)

Name : _____ ()

Class : Primary 6 _____

Date : 10 May 2021

Total time for Booklet A and B : 1 hour

15 questions

20 marks

Parent's signature : _____

INSTRUCTIONS TO CANDIDATES

Do not turn over this page until you are told to do so.

Follow all instructions carefully.

Answer all questions.

Shade your answers in the Optical Answer Sheet (OAS) provided.

The use of calculators is **NOT** allowed.

Booklet A and B consist of 15 printed pages excluding the cover pages.

Questions 1 to 10 carry 1 mark each. Questions 11 to 15 carry 2 marks each. For each question, four options are given. One of them is the correct answer. Make your choice (1, 2, 3 or 4). Shade the oval (1, 2, 3 or 4) on the Optical Answer Sheet. All diagrams are not drawn to scale. (20 marks)

1. Which of the following is the same as 3070 m?

- (1) 3 km 7 m
- (2) 3 km 70 m
- (3) 30 km 7 m
- (4) 30 km 70 m

2. Round 21 905 to the nearest thousand.

- (1) 20 000
- (2) 21 000
- (3) 21 900
- (4) 22 000

3. Which line in the square grid is perpendicular to AD?

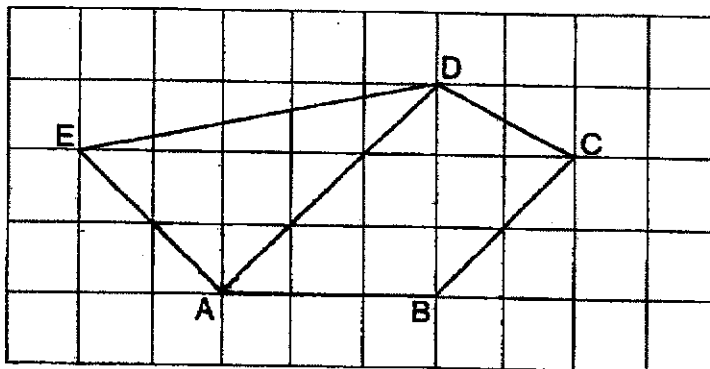

- (1) AE
- (2) BC
- (3) CD
- (4) DE

4. In the figure, AOB is a straight line. $\angle COD = 175^\circ$ and $\angle BOD = 33^\circ$. Find $\angle AOC$.

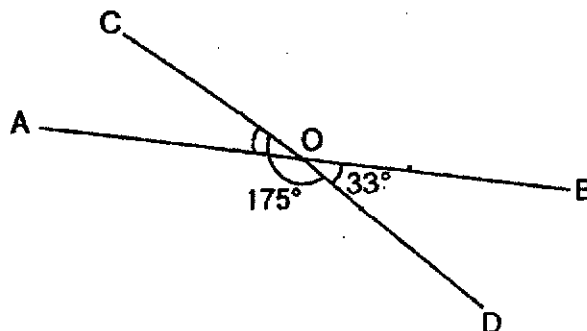

- (1) 28°
(2) 33°
(3) 142°
(4) 147°
-
5. Which one of the following is the same as $3 + \frac{2}{5}$?

- (1) $\frac{1}{3} \times \frac{2}{5}$
(2) $\frac{1}{3} \times \frac{5}{2}$
(3) $\frac{3}{1} \times \frac{2}{5}$
(4) $\frac{3}{1} \times \frac{5}{2}$
-

6. The graph shows the height of a plant measured at the end of each week over a period of 5 weeks.

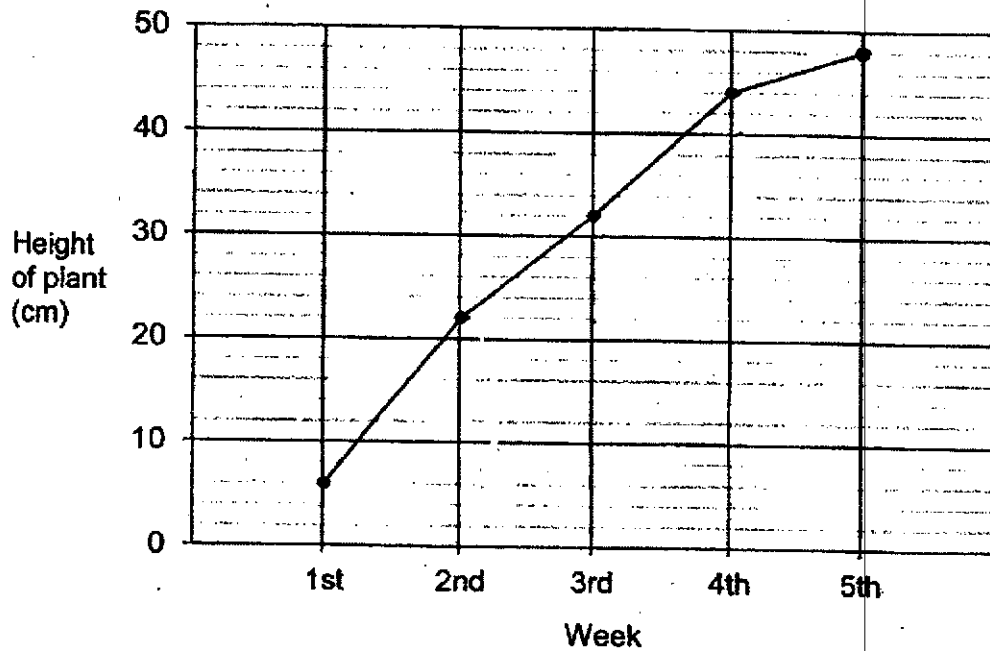

During which one-week period did the plant grow the most?

- (1) Between 1st and 2nd week
 - (2) Between 2nd and 3rd week
 - (3) Between 3rd and 4th week
 - (4) Between 4th and 5th week
-
7. The solid shown is formed using some unit cubes. How many unit cubes are used to form the solid?

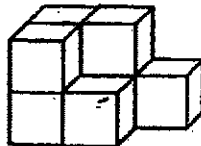

- (1) 6
- (2) 7
- (3) 8
- (4) 9

8. Bing Xuan cycled around a park for 140 minutes. He finished cycling at 1.30 p.m. At what time did he start cycling?
- (1) 3.10 p.m.
 - (2) 3.50 p.m.
 - (3) 11.10 a.m.
 - (4) 11.50 a.m.
-

9. The figure below is made up of 6 identical rectangles. Each rectangle measures 8 cm by 3 cm each. What is the perimeter of the figure?

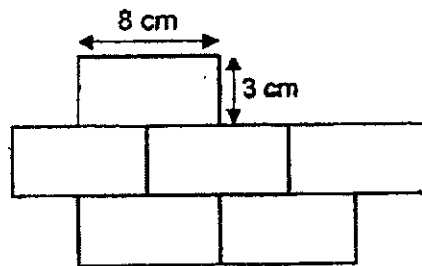

- (1) 22 cm
 - (2) 66 cm
 - (3) 132 cm
 - (4) 144 cm
-

10. In the figure below, ABC is a triangle.
Given that AC is the base of triangle ABC, which is the height of triangle ABC?

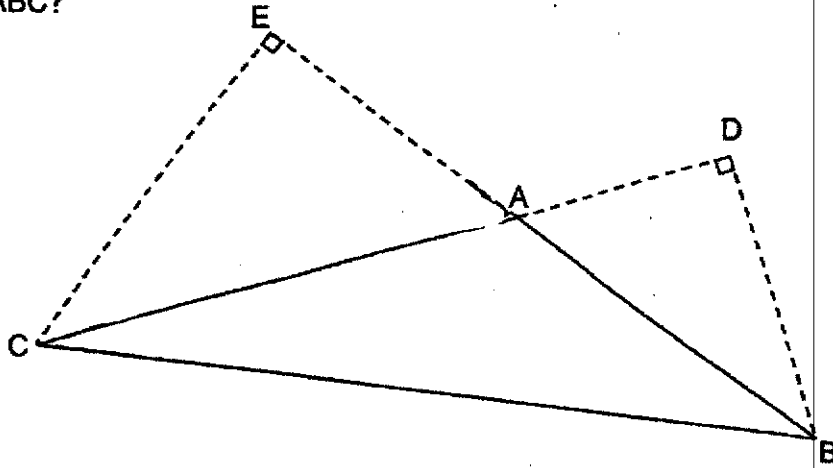

- (1) AB
(2) BC
(3) CE
(4) DB
-
11. Arrange these masses from the lightest to the heaviest.

1.45 kg	$1\frac{4}{5}$ kg	1 kg 405 g
---------	-------------------	------------

- | | <u>Lightest</u> | , | <u>Heaviest</u> |
|-----|-------------------|---|-------------------|
| (1) | 1 kg 405 g | , | 1.45 kg |
| (2) | 1 kg 405 g | , | $1\frac{4}{5}$ kg |
| (3) | $1\frac{4}{5}$ kg | , | 1 kg 405 g |
| (4) | 1.45 kg | , | $1\frac{4}{5}$ kg |

12. The price of a teddy bear was \$30. Joey bought one such teddy bear and had to pay 7% GST on the price. How much did she pay for the teddy bear?
- (1) \$2.10
 - (2) \$27.90
 - (3) \$32.10
 - (4) \$37
-

13. Tara had $\frac{5}{6}$ m of string. She cut the greatest number of pieces of $\frac{1}{8}$ m each from the string. What was the length of the string left over?
- (1) $\frac{1}{12}$ m
 - (2) $\frac{2}{3}$ m
 - (3) $\frac{1}{6}$ m
 - (4) $\frac{17}{24}$ m
-

14. The figure is formed using a semicircle and a quarter circle of radius 8 cm. Find the perimeter of the figure. Leave your answer in terms of π .

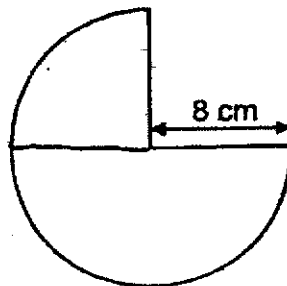

- (1) $(6\pi + 16)$ cm
 - (2) $(12\pi + 16)$ cm
 - (3) $(16\pi + 16)$ cm
 - (4) $(48\pi + 16)$ cm
-

15. Rhombus WXYZ and Trapezium EFGH are shown in the square grid below.

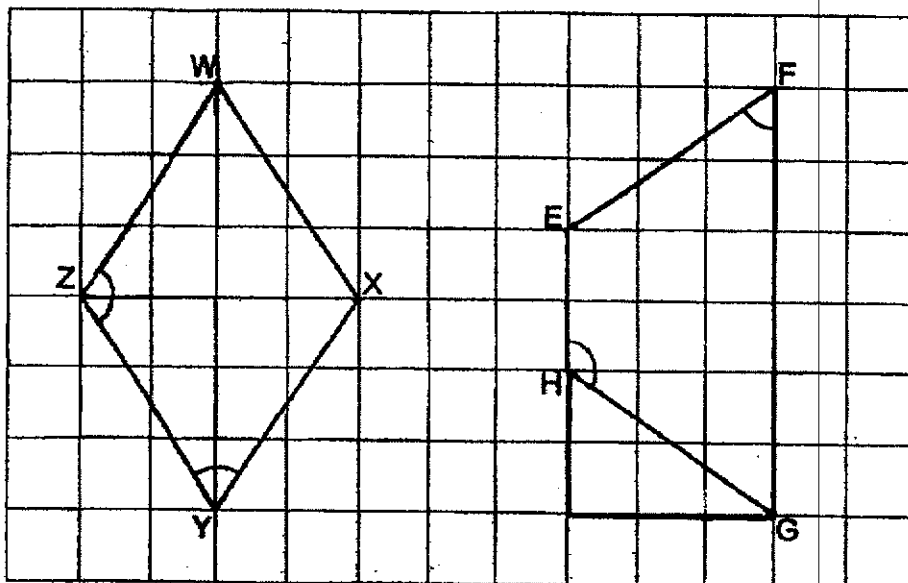

Based on what is shown in the square grid, which of the following statement(s) is/are true?

Statement A: ZY is parallel to HG.

Statement B: $\angle WZY$ is twice of $\angle EFG$.

Statement C: Area of rhombus WXYZ is equal to area of trapezium EFGH.

- (1) A only
 (2) C only
 (3) A and B only
 (4) B and C only

END OF BOOKLET A

Questions 16 to 20 carry 1 mark each. Write your answers in the spaces provided. For questions which require units, give your answers in the units stated. All diagrams are not drawn to scale. (5 marks)

Do not write
in this space

16. Write one million and twelve in numerals.

Ans: _____

17. List all the common factors of 27 and 45.

Ans: _____

18. What is the value of $39 - 36 + (5 + 4) + 3$?

Ans: _____

19. Find the value of $\frac{8n}{3} - n$ when $n = 6$.

Do not write
in this space

Ans: _____

20. Express 0.9% as a fraction.

Ans: _____

Total marks for questions 16 to 20

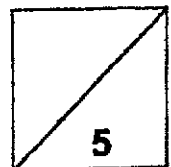

9

(Go on to the next page)

Questions 21 to 30 carry 2 marks each. Show your working clearly and write your answers in the spaces provided. For questions which require units, give your answers in the units stated. All diagrams are not drawn to scale.

Do not write
in this space

(20 marks)

21. The number of visitors to an amusement park was 4200 in June. This was a 20% increase from the number of visitors in May. How many visitors were there in May?

Ans: _____

22. A bag contains balls of three different colours. $\frac{1}{3}$ of the balls are green. The ratio of the number of blue balls to that of the red balls is 4 : 5. What is the ratio of the number of green balls to that of the blue balls?

Ans: _____

23. The solid shown below is made up of 6 unit cubes.

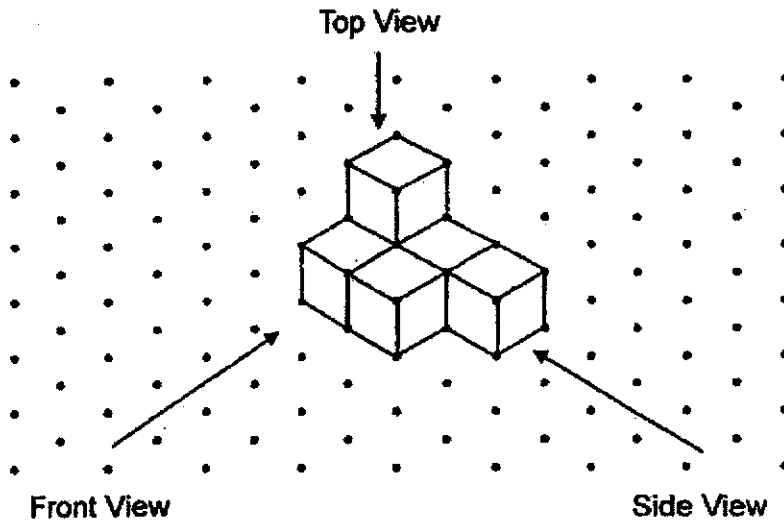

Do not write
in this space

Draw the front view and top view of the solid on the grid below.

<p>Front View</p>	<p>Top View</p>
-------------------	-----------------

24. A machine prints 350 pieces of paper in 21 minutes. At this rate, how long does the machine take to print 150 pieces of paper?

Ans: _____ min

25. In the figure, JKLM is a rectangle and MNPQ is a square. $\angle JKM = 26^\circ$, $\angle PMJ = 18^\circ$. Find $\angle QMK$.

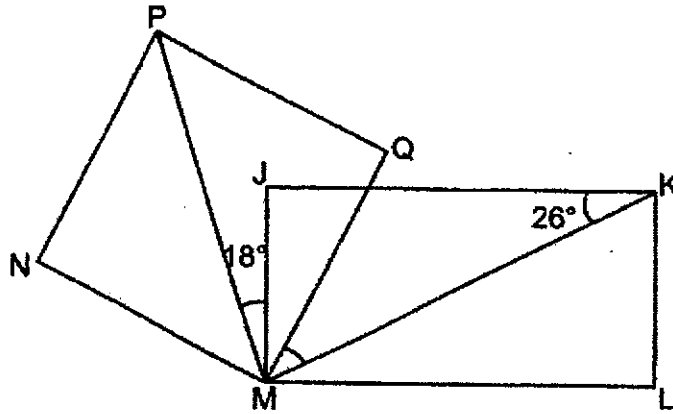

Do not write in this space

Ans: _____

26. The table shows the rental charges for a car.

First 3 hours	\$90
Every additional hour	\$40

Mrs Chua paid \$290 for renting a car. How many hours did she rent the car for?

Ans: _____ h

27. Francis baked thrice as many muffins as tarts. After giving away 67 muffins and 13 tarts, Francis had equal number of muffins and tarts. How many tarts did Francis bake?

Do not write
in this space

Ans: _____

28. Eric started cycling at 25-km/h from his house to the swimming complex. The swimming complex is 10 km away from his house. How long did he take to reach the swimming complex?

Ans: _____ min

29. In the square grid below, Figure STU is a triangle.

- (a) Measure and write down the value of $\angle SUT$.
- (b) Draw a parallelogram SWXT such that it is twice the area of triangle STU. Parallelogram SWXT must not overlap triangle STU.

Do not write in this space

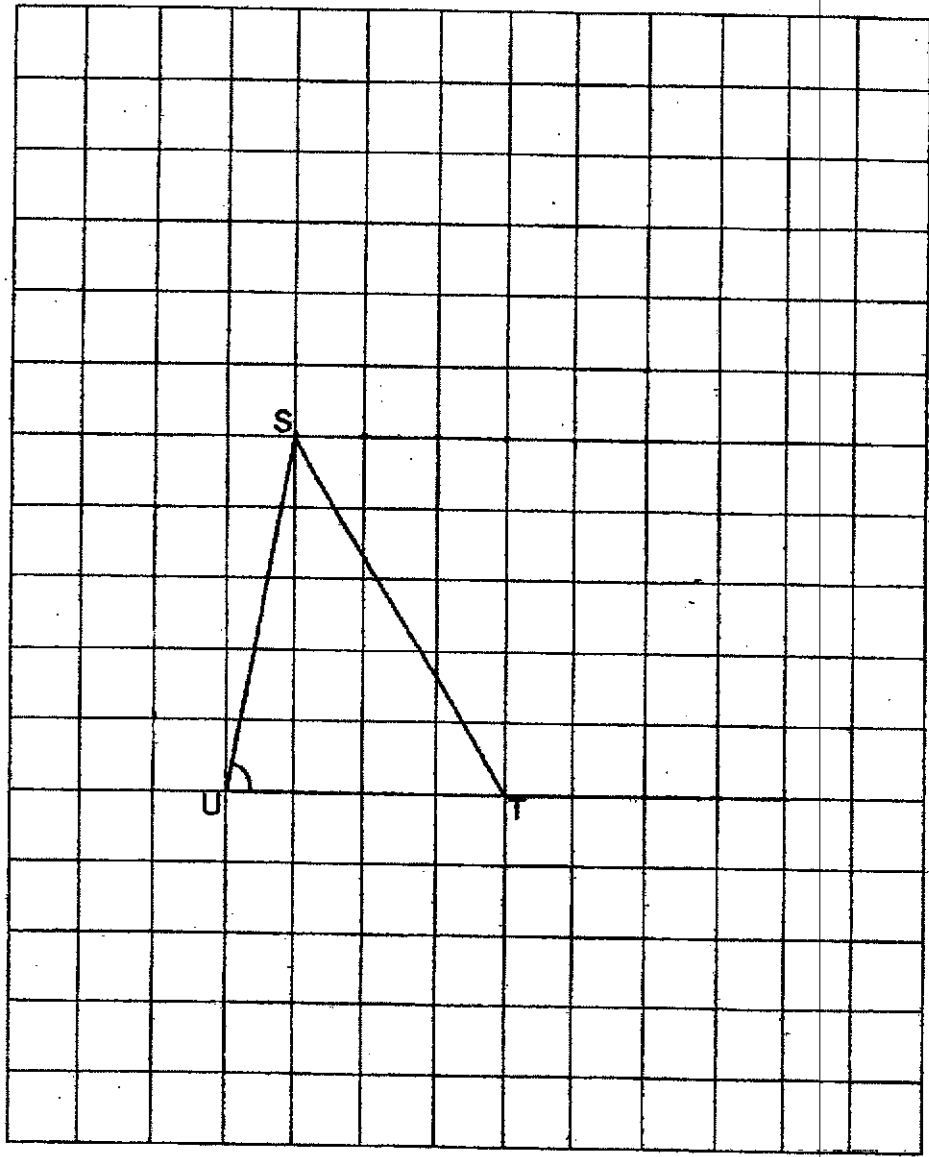

Ans: (a) _____ °



30. Linda's home, her school and the market are located as shown in the square grid below.

Do not write in this space

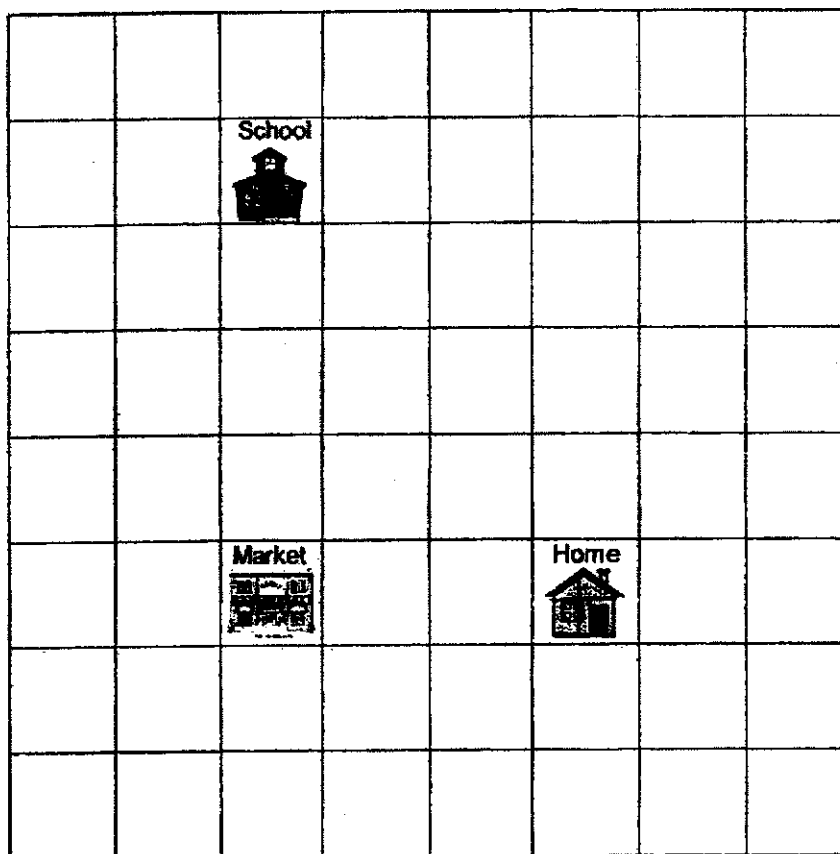

- (a) In what direction is the market from Linda's home?
- (b) A new shopping centre will be built at a location south-east of the school and north-east of the market. Put a tick (✓) in the square where the new shopping centre will be built.

Ans: (a) _____



Total marks for questions 21 to 30

END OF BOOKLET B
END OF PAPER 1

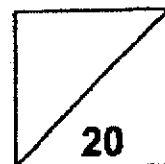

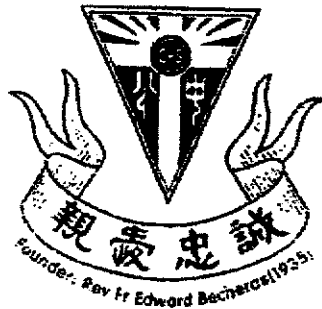

CATHOLIC HIGH SCHOOL
MID-YEAR EXAMINATION (2021)
PRIMARY SIX
MATHEMATICS
PAPER 2

Name : _____ ()

Class : Primary 6 _____

Date : 10 May 2021

Total time : 1 h 30 min

17 questions

55 marks

Parent's signature : _____

PAPER 1 BOOKLET A	20
PAPER 1 BOOKLET B	25
PAPER 2	55
Total Marks	100

INSTRUCTIONS TO CANDIDATES

Do not turn over this page until you are told to do so.

Follow all instructions carefully.

Answer all questions.

Write your answers in this booklet.

The use of an approved calculator is expected, where appropriate.

This booklet consists of 15 printed pages excluding the cover pages.

Questions 1 to 5 carry 2 marks each. Show your working clearly in the space below each question and write your answers in the spaces provided. For questions which require units, give your answers in the units stated. All diagrams are not drawn to scale. (10 marks)

Do not write
in this space

1. Michelle spent \$6 more than Nicole. They spent \$ m in total. How much did Michelle spend? Give your answer in terms of m .

Ans: \$ _____

2. The average of three different numbers is 210. All the numbers are 3-digit whole numbers. One of the numbers is 180. What is the largest possible difference between the other two numbers?

Ans: _____

3. Wayne drove a car for one hour for the first 75 km of a journey. He completed the remaining 45 km of the journey in half an hour. What was Wayne's average speed for the whole journey?

Do not write in this space

Ans: _____ km/h

4. In the figure below, PQR and TUS are identical right-angled triangles. The total area of the unshaded parts is 292 cm^2 . Find the area of the shaded part.

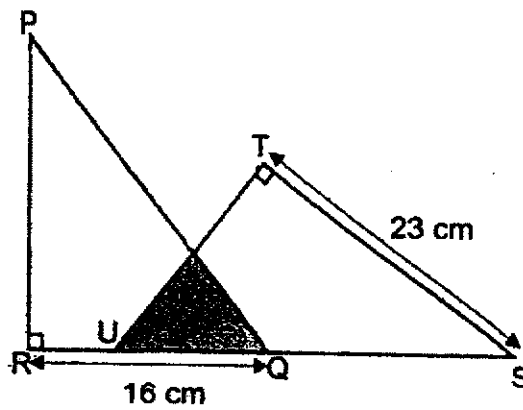

Ans: _____ cm^2

5. Aaron and Brenda had the same number of coins at first. Each child had a mix of twenty-cent and fifty-cent coins. Aaron had 7 more twenty-cent coins than Brenda. Both children spent money at a shop and Aaron spent more money than Brenda.

Do not write
in this space

Statement (a) and (b) are either true, false or not possible to tell from the information given above. For statement (a) and (b), put a tick (✓) in the correct column.

Statement	True	False	Not possible to tell
(a) Aaron had more money than Brenda at first.			
(b) Brenda had more coins than Aaron at the end.			

For questions 6 to 17, show your working clearly in the space provided for each question and write your answers in the spaces provided. The number of marks available is shown in brackets [] at the end of each question or part-question. (45 marks)

Do not write in this space

6. A group of children was asked to choose one ice-cream flavour from Chocolate, Vanilla, Strawberry and Mango. The bar graph below represents the children's choices of ice-cream flavour. The bar that shows the number of children who chose mango ice-cream has not been drawn.

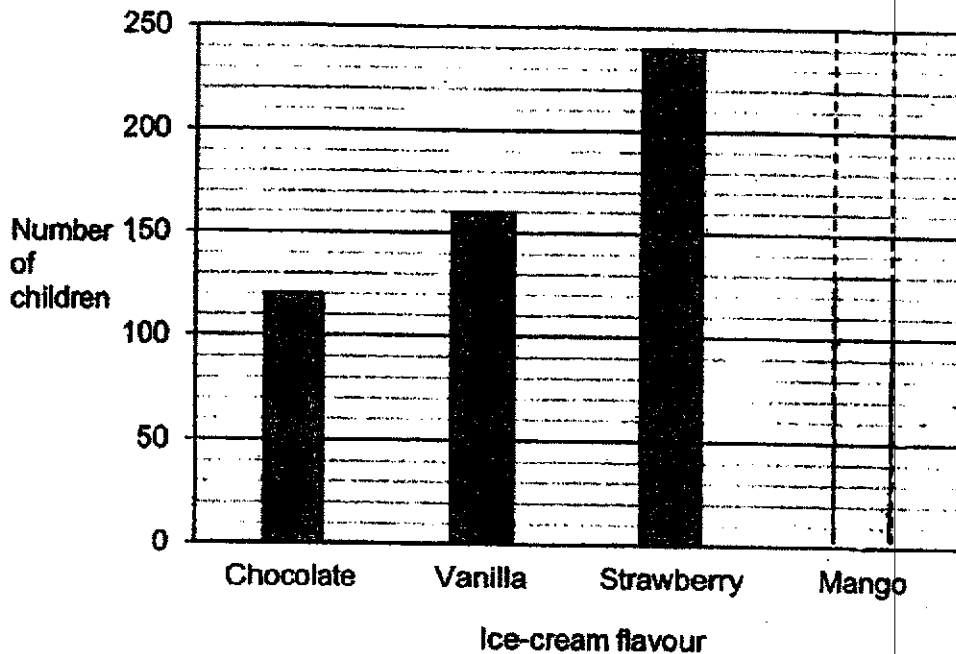

[2]

- (a) What was the ratio of the number of children who chose chocolate ice-cream to the total number of children who chose vanilla and strawberry ice-cream? Give your answer in the simplest form.
- (b) $\frac{1}{5}$ of the children chose mango ice-cream. Draw the bar that shows the number of children who chose mango ice-cream in the graph above.

Ans:(a) _____ [1]



7. Richard needed to fold 356 paper cranes for a charity event. He folded 9 paper cranes each day from Monday to Friday and 17 paper cranes each day on Saturday and Sunday. Starting on a Saturday, on which day of the week did Richard finish folding 356 paper cranes?

Do not write
in this space

Ans: _____ [3]

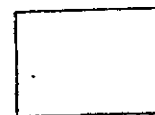

8. Figure 1 is made up of 4 identical rectangles. The area of Figure 1 is 192 cm^2 . The rectangles are rearranged in Figure 2. Find the height of Figure 2.

Do not write in this space

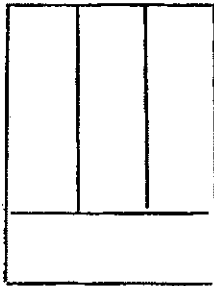

Figure 1

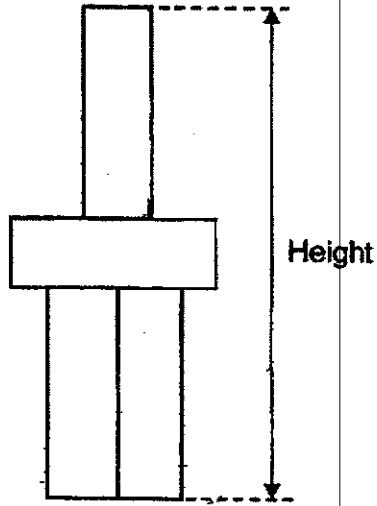

Figure 2

Ans: _____ [3]



9. There were some black beads and white beads in a box. The number of black beads was $\frac{2}{5}$ of the number of white beads. After 12 black beads and 44 white beads were taken out of the box, the number of black beads left in the box was $\frac{2}{3}$ of the number of white beads left in the box. How many beads were left in the box?

Do not write
in this space

Ans: _____ [3]



10. Eugene and Frank had a total of 272 stamps. Eugene gave $\frac{1}{3}$ of his stamps to Frank. Frank then gave $\frac{1}{5}$ of his stamps to Eugene. In the end, each of them had the same number of stamps. How many stamps did Eugene have at first?

Do not write
in this space

Ans: _____ [3]

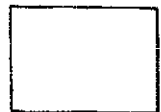

11. Four teams of pupils sold bottles of sweets at a carnival. They sold a big bottle of sweets for \$7 and a small bottle of sweets for \$4. The table shows the number of bottles of sweets sold by three of the teams.

Do not write
in this space

Team	Number of bottles of sweets sold	
	Small	Big
A	3	12
B	13	6
C	8	9

- (a) Which of the three teams collected the least amount of money?
What was the amount of money collected?
- (b) Team D sold 3 times as many big bottles of sweets as small bottles of sweets. The team collected \$225. How many small bottles of sweets did Team D sell?

Ans: (a) Team: _____

Amount: _____ [2]

(b) _____ [2]



12. In the figure, FAB and BEF are triangles. FCDE is a trapezium. $\angle FAB = 15^\circ$ and $\angle CDE = 116^\circ$. $FA = FB = FE$. Find $\angle CED$.

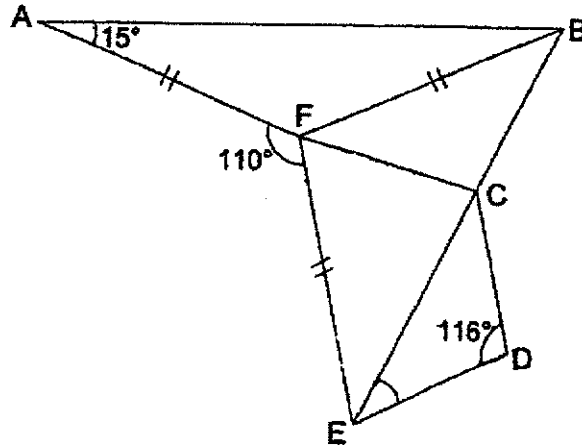

Do not write
in this space

Ans: _____ [4]



13. Tank A has a rectangular base measuring 55 cm by 60 cm. It is filled with water to a height of 45 cm. 82.5 l of water is then poured into the tank to fill it to the brim.

Do not write in this space

- (a) What is the capacity of tank A in litres?
- (b) All the water in the tank is then poured into some containers to the brim without spilling. Each container measures 12 cm by 8 cm by 10 cm. What is the greatest number of such containers that can be filled completely with water?

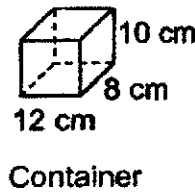
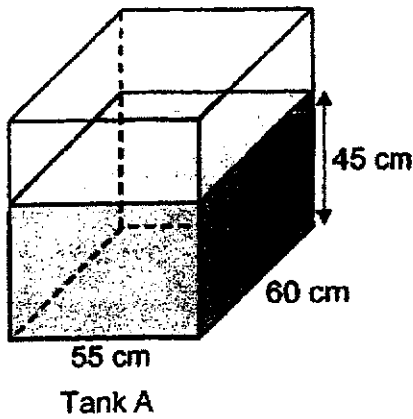

Ans: (a) _____ [2]
(b) _____ [2]



14. Jenny bought a coffee maker for \$190.50 after a 25% discount.
- (a) What was the price of the coffee maker before the discount?
- (b) She paid \$193.80 for an oven. The total discount for the coffee maker and the oven was \$97.70. What was the percentage discount given for the oven?

Do not write
in this space

Ans: (a) _____ [2]

(b) _____ [2]



15. The figure shows a path of width 3 m in a rectangular garden of length 34 m. The outline of the path is made up of quarter circles with centre S and centre X, semicircles with centre V and straight lines. $ST = UV = WX$.

Do not write
in this space

- (a) Find the breadth of the rectangular garden.
(b) Find the area of the path. Take $\pi = 3.14$

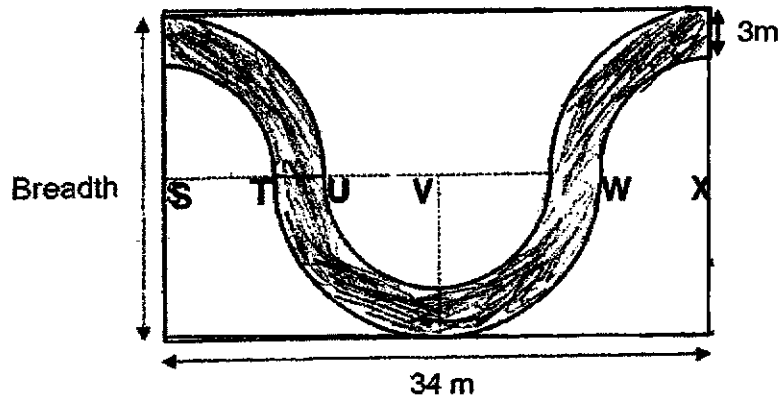

Ans: (a) _____ [2]

(b) _____ [2]



16. Chloe baked 1023 chocolate and vanilla buns. After selling an equal number of chocolate and vanilla buns, she had $\frac{1}{4}$ of the chocolate buns and $\frac{1}{5}$ of the vanilla buns left. She packed the remaining chocolate buns into 27 boxes. Some boxes contained 4 chocolate buns while some contained 7 chocolate buns.
- (a) How many chocolate buns were packed into boxes?
- (b) How many boxes contained 7 chocolate buns?

Do not write
in this space.

Ans: (a) _____ [3]

(b) _____ [2]

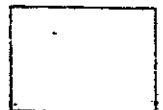

17. Shaded and unshaded squares are used to form the figures that follow a pattern. The first four figures are shown below.

Do not write
in this space



Figure 1



Figure 2

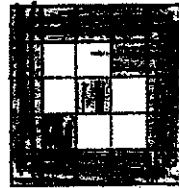

Figure 3

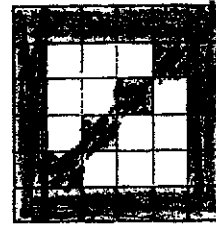

Figure 4

The table below shows the number of shaded and unshaded squares used for each figure.

Figure Number	Number of shaded squares	Number of unshaded squares	Total number of squares
1	9	0	9
2	14	2	16
3	19	6	25
4	24	12	36
5			49

- (a) Complete the table for Figure 5.
 (b) Find the total number of squares in Figure 10.
 (c) Which figure number has 119 shaded squares?

Ans: (b) _____ [2]

(c) _____ [2]



END OF PAPER 2

ANSWER KEY

YEAR : 2021
LEVEL : PRIMARY 6
SCHOOL : CATHOLIC HIGH
SUBJECT : MATHEMATICS
TERM : MID-YEAR EXAM

BOOKLET A (PAPER 1)

Q1	2	Q2	4	Q3	1	Q4	1	Q5	4
Q6	1	Q7	3	Q8	3	Q9	2	Q10	4
Q11	1	Q12	3	Q13	1	Q14	2	Q15	4

BOOKLET B (PAPER 1)

Q16	1000012	Q17	1, 3, 9
Q18	$39 - 36 \div 9 + 3$ $= 39 - 4 + 3$ $= 35 + 3 = 38$	Q19	$\frac{2 \times 6}{3} - 6 = \frac{48}{3} - 6$ $= 16 - 6 = 10$
Q20	$0.9 \div 100 = \frac{0.9}{100} = \frac{9}{1000}$	Q21	$120\% = 4200$ $1\% = 4200 \div 120 = 35$ $100\% = 35 \times 100 = 3500$
Q22	g : b 9 : 8	Q23	<div style="display: flex; justify-content: space-around;"> <div style="text-align: center;"> <p>Front View</p> </div> <div style="text-align: center;"> <p>Top View</p> </div> </div>
Q24	350 pic \rightarrow 21min 50 pic \rightarrow 3min 150 pic \rightarrow 9min	Q25	$\angle JMQ = 45^\circ - 18^\circ = 27^\circ$ $\angle QMK = 90^\circ - 27^\circ - 26^\circ = 37^\circ$
Q26	$\$290 - \$90 = \$200$ $5h + 3h = 8h$	Q27	$2u = 67 - 13 = 54$ $1u = 54 \div 2 = 27$
Q28	$\text{Time} = \frac{D}{S} = \frac{10}{25}$ $= \frac{2}{5}h$ $\frac{2}{5} \times \frac{60}{1} \text{min} = 24 \text{min}$	Q29	a) 79° b)
Q30	a) West b)		

PAPER 2

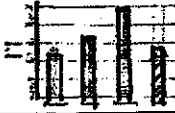
Q1	$N = (m-6) \div 2 = \frac{m-6}{2}$ $M = \frac{m-6}{2} + 6$ $= \$\left(\frac{m-6}{2} + 6\right)$	Q2	Total = $210 \times 3 = 630$ $630 - 180 = 450$ Diff = $350 - 100 = 250$
Q3	TD = 120km AS = $120\text{km} \div 1.5\text{h} = 80\text{km/h}$ TT = 1.5h ANS : 20km/h	Q4	$\frac{1}{2} \times 16 \times 23 = 184$ $292 \div 2 = 146$ $184 - 146 = 38\text{cm}^2$
Q5	a) False b) Not possible to tell	Q6	a) C : V+S $120 : 400$ $12 : 40$ $3 : 10$ b) 
Q7	Sat to Sun $356 - 34 = 322$ 1 week = $34 + 45 = 79$ No. of weeks = $322 \div 79$ OR $9 \times 5 + 17 \times 2 = 79$ $356 \div 79 = 4\text{R}40$ Richard finished on Monday ANS : Monday	Q8	Area of 1 small rect $= 192\text{cm}^2 \div 4 = 48\text{cm}^2$ Area of 3 small rect $= 48\text{cm}^2 \times 3 = 144\text{cm}^2$ $\sqrt{144} = 12$ $1b = 12\text{cm} \div 3 = 4\text{cm}$ $1c = 12\text{cm}$ $H = 2L + 1b$ $= (12\text{cm} \times 2) + 4\text{cm} = 28\text{cm}$
Q9	$2u = 44 - (6 \times 5) = 14$ $1u = 74 \div 2 = 7$ $5u = 7 \times 5 = 35$	Q10	$E \frac{1}{5} = 136 \div 4 = 34$ $E \frac{1}{3} = 102 \div 2 = 51$ ANS : 153
Q11	a) Team : B Amount : \$94 $13s = \$4 \times 13 = \52 $6b = \$7 \times 6 = \42 Total = $\$52 + \$42 = \$94$ b) 1gp cost = \$25 No. of gps = $225 \div 25 = 9$ Small = $9 \times 1 = 9$	Q12	$\angle AFB = 180^\circ - 15^\circ - 15^\circ = 150^\circ$ $\angle BFE = 360^\circ - 150^\circ - 110^\circ = 100^\circ$ $\angle CEF = (180^\circ - 100^\circ) \div 2 = 40^\circ$ $\angle CED = 180^\circ - 116^\circ - 40^\circ = 24^\circ$ $\angle CED$ is 24°
Q13	a) Vol of water in A $= 55\text{cm} \times 45\text{cm} \times 60\text{cm} = 148500\text{cm}^3$ $148500\text{cm}^3 = 148500\text{ml}$	Q14	a) $75\% = \$19050$ $1\% = \$190.50 \div 75$ $= \$2.54$

	<p>$148500\text{ml} = 148.5\text{L}$ $\text{Cap of A} = 148.5\text{L} + 82.5\text{L} = 231\text{L}$ b) $12 \times 8 \times 10 = 960$ $231000 \div 960 = 240.625 \approx 240$</p>		<p>$100\% = \\$2.54 \times 100$ $= \\$254$ b) Discount of coffee marker $= 25\%$ $= \\$2.54 \times 25 = \\63.50 Discount for oven $= \\$97.70 - \\$63.50 = \\$34.20$ 100% oven $= \\$34.20 + \\$193.80 = \\$228$ % Discount $= \frac{34.20}{228} \times 100\% = 15\%$ The percentage discount is 15%</p>																														
Q15	<p>a) $(34 - 3 - 3) \div 4 = 7$ $(3 + 7) \times 2 = 20\text{m}$ b) Area = Big Circle - small circle $= 3.14 \times 10\text{m} \times 10\text{m} - 3.14 \times 7\text{m} \times 7\text{m}$ $= 160.14\text{m}^2$ Area of the path is 160.14m²</p>	Q16	<p>a) $31u = 1023$ $1u = 1023 \div 31 = 33$ $4u = 33 \times 4 = 132$ b) $27 \times 4 = 108$ $132 - 108 = 24$ $24 \div 3 = 8$</p>																														
Q17	<table border="1"> <tr> <td>a)</td> <td>Figure</td> <td>Number of shaded squares</td> <td>Number of unshaded squares</td> <td>Total number of squares</td> </tr> <tr> <td></td> <td>1</td> <td>9</td> <td>0</td> <td>9</td> </tr> <tr> <td></td> <td>2</td> <td>14</td> <td>2</td> <td>16</td> </tr> <tr> <td></td> <td>3</td> <td>19</td> <td>6</td> <td>25</td> </tr> <tr> <td></td> <td>4</td> <td>24</td> <td>12</td> <td>36</td> </tr> <tr> <td></td> <td>5</td> <td>29</td> <td>20</td> <td>49</td> </tr> </table> <p>b) Fig 10 = $(10+2) \times (10+2)$ $= 12 \times 12 = 144$ c) $119 - 9 = 110$ $110 \div 5 = 22$ $22 + 1 = 23$</p>	a)	Figure	Number of shaded squares	Number of unshaded squares	Total number of squares		1	9	0	9		2	14	2	16		3	19	6	25		4	24	12	36		5	29	20	49		
a)	Figure	Number of shaded squares	Number of unshaded squares	Total number of squares																													
	1	9	0	9																													
	2	14	2	16																													
	3	19	6	25																													
	4	24	12	36																													
	5	29	20	49																													

3
END

