

CA1



Henry Park Primary School  
Primary Six Science  
Term Review 2021

Name: \_\_\_\_\_ ( ) Class: 6 \_\_\_\_\_ Parent's Signature: \_\_\_\_\_

Booklet A (56 marks)

For each question from 1 to 28, four options are given. One of them is the correct answer.

Make your choice (1, 2, 3 or 4). Shade the correct oval (1, 2, 3 or 4) on the **Optical Answer Sheet**.

1. The diagram shows organism M growing on a slice of bread. It breaks down the bread and absorbs nutrients from it.

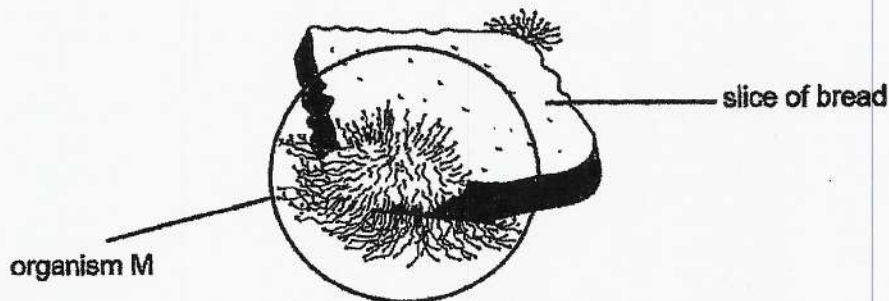

Which of the following belong to the same group of living things as organism M?

- |            |            |
|------------|------------|
| A fern     | B yeast    |
| C bacteria | D mushroom |

- (1) A and D only  
(2) B and D only  
(3) B and C only  
(4) A, C and D only



2. The pictures show 6 animals.

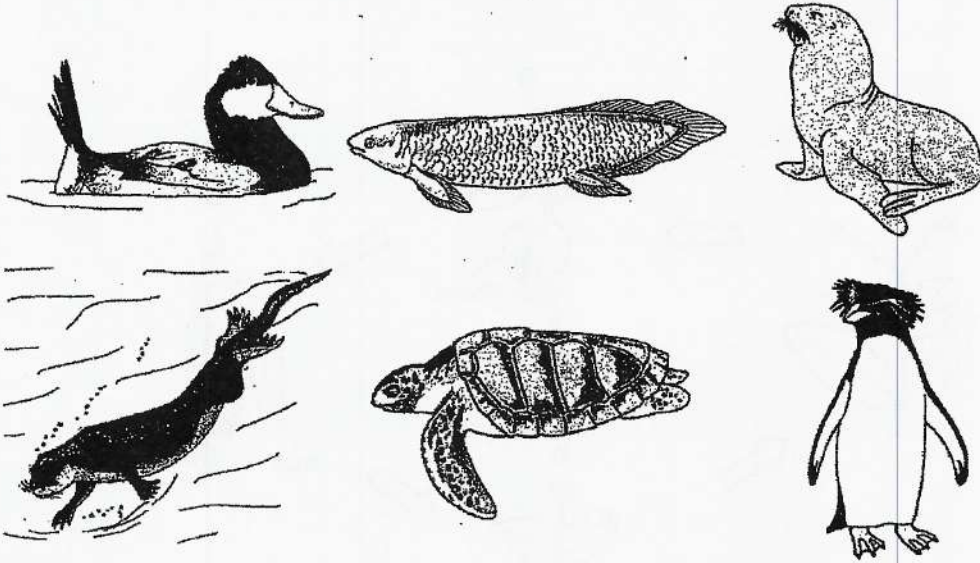

Based on the information given, which of the following shows the correct number of animals in each animal group?

- (1)
 

Mammal	Fish	Bird	Amphibian
2	1	2	1
  
- (2)
 

Mammal	Fish	Bird	Reptile
2	1	2	1
  
- (3)
 

Mammal	Fish	Bird	Reptile
1	1	2	2
  
- (4)
 

Mammal	Amphibian	Bird	Reptile
2	1	1	2

3. The diagram shows the different stages in the life cycle of a flowering plant.

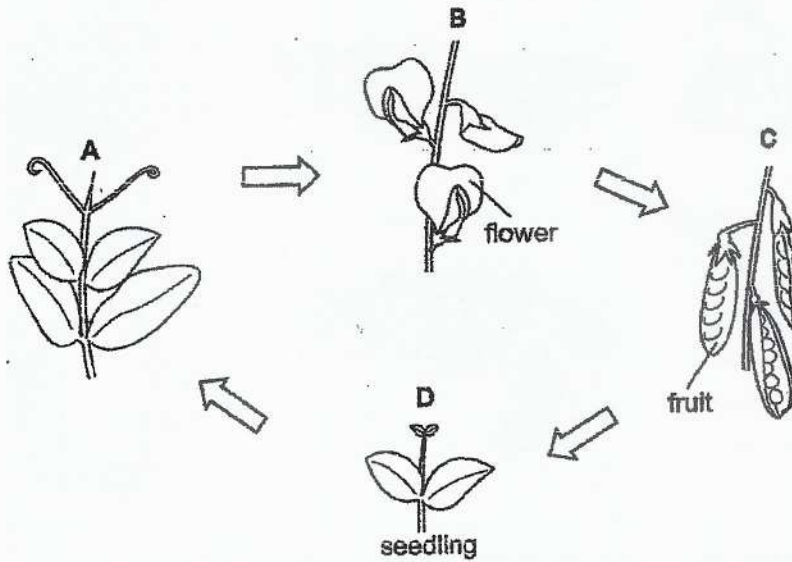

Based on the information given, which of the following statements are correct?

- A Pollination and fertilisation occur between stages B and C.
- B The stages show the growth and reproduction of a living thing.
- C Dispersal and germination of seeds occur between stages C and D.

- (1) A and C only
- (2) A and B only
- (3) B and C only
- (4) A, B and C

4. The diagram shows Jeffrey blowing up a balloon.



How does the percentage of gases in the air inside the balloon compare with those in the surrounding air?

Percentage of gases in the air inside the balloon			
	oxygen	carbon dioxide	water vapour
(1)	more	less	more
(2)	more	less	less
(3)	less	more	more
(4)	less	more	less

5. May Lin observed some living things in her garden and recorded her observations in the table shown below.

Which living thing, E, F, G or H, is likely to be a fern?

	living thing	Is the part present?			
		stem	spores	flowers	leaves
(1)	E	✓			✓
(2)	F		✓		
(3)	G	✓	✓		✓
(4)	H	✓		✓	✓

**Key**

✓ part is present



6. The diagram shows an experiment set up by Mani.

The amount of carbon dioxide in the water in each test-tube was measured at the start of the experiment and again three hours later.

In which test-tube, 1, 2, 3 or 4, will the amount of carbon dioxide decrease?

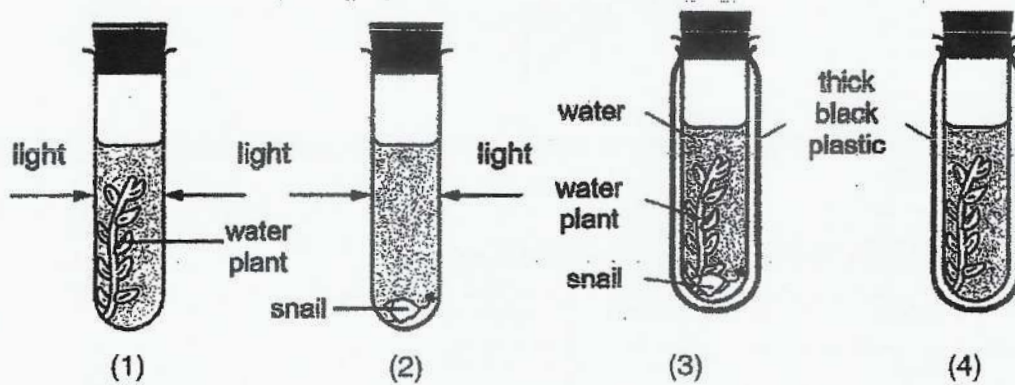

7. The diagrams show drawings of a leaf cell done by four students.

Which of the following diagrams of a leaf cell is the most accurate?

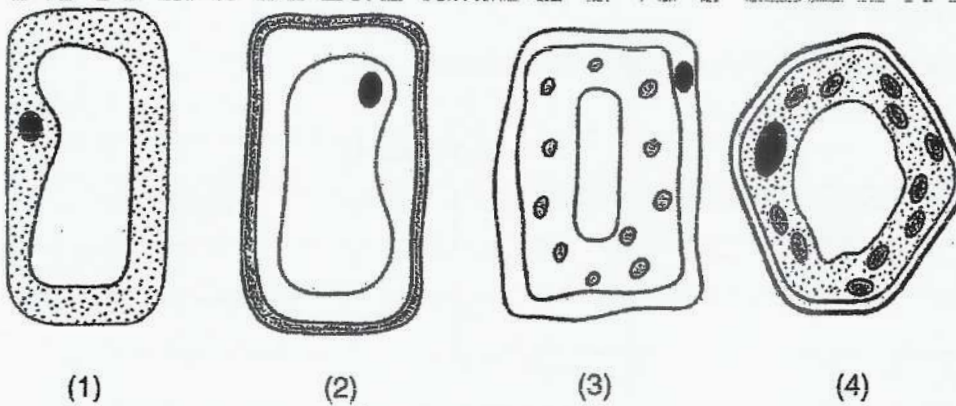

8. The diagram shows the early stages of the growth of a flowering plant.

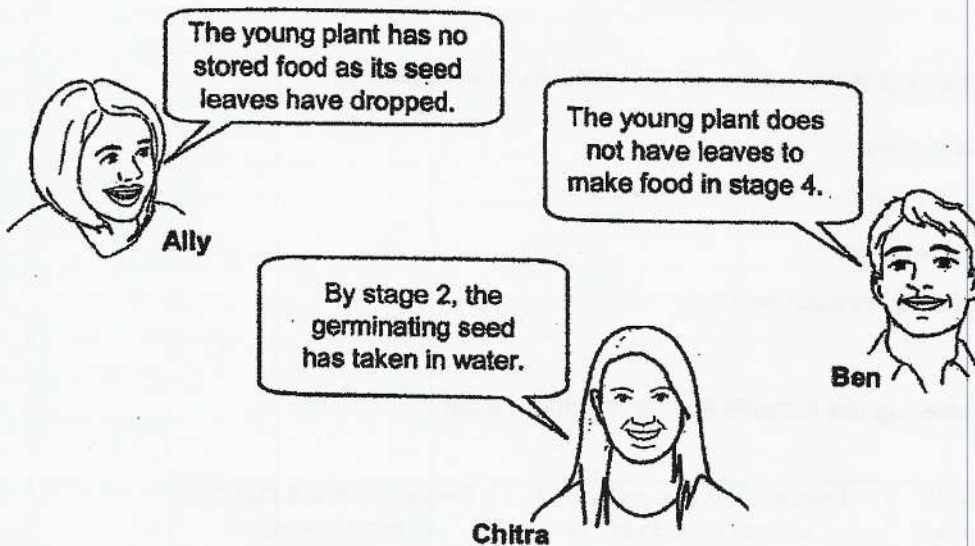
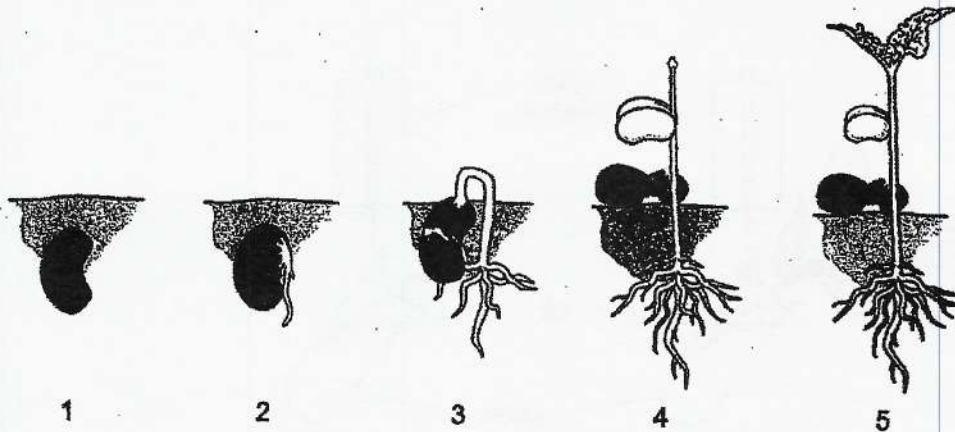

Based on the information given, whose statements are correct?

- (1) Ally and Ben only
- (2) Ben and Chitra only
- (3) Ally and Chitra only
- (4) Ally, Ben and Chitra

9. Molly wants to investigate how water is lost through the leaves. The diagram shows two shoots, taken from the same plant, at the start of an experiment.

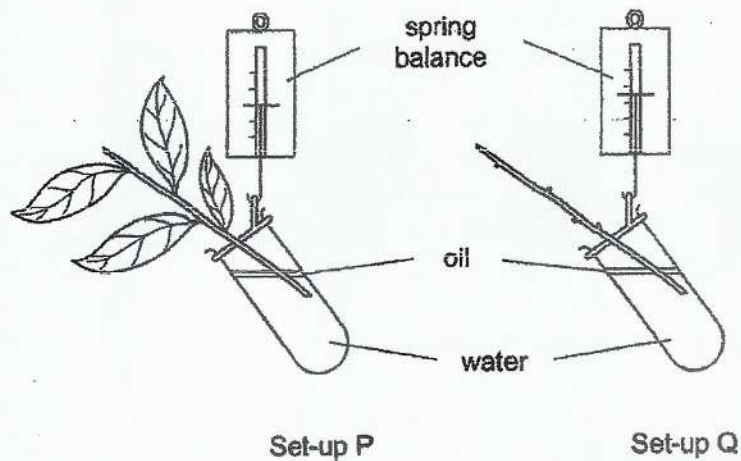

Which of the following is the independent variable in this experiment?

- (1) number of leaves
  - (2) thickness of stem
  - (3) amount of water lost
  - (4) amount of water in each set-up
10. Which of the following are possible effects of deforestation?

	Increase in soil erosion?	Decrease in the amount of carbon dioxide in the atmosphere?	Decrease in the number of plant species?
(1)	yes	no	yes
(2)	yes	yes	yes
(3)	no	yes	no
(4)	no	no	no



11. The diagrams show where some parent plants and their seedlings are growing.

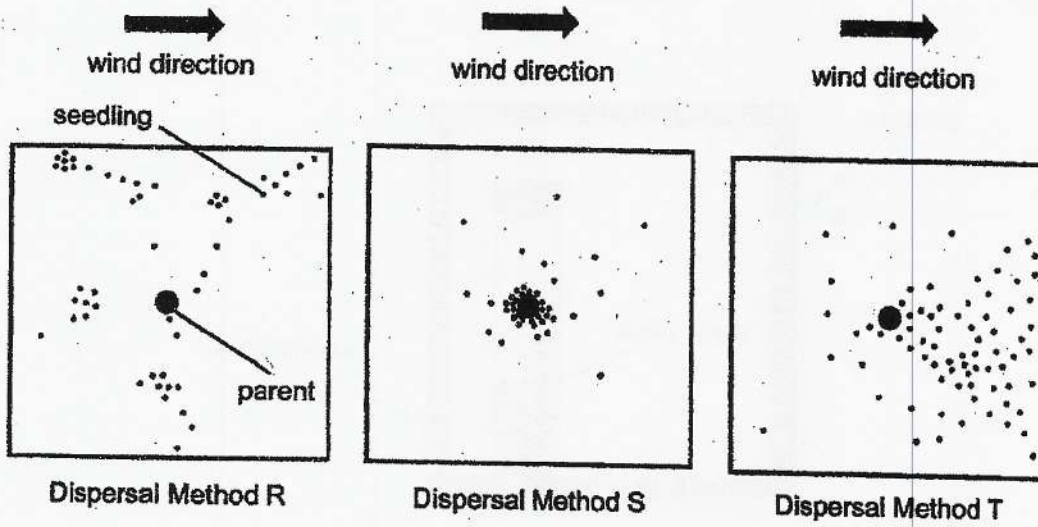

Based on the information given, how are the seeds shown below dispersed?

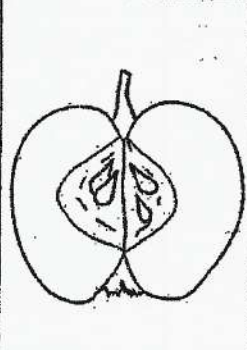
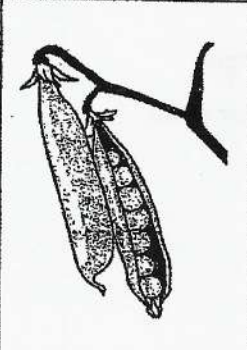
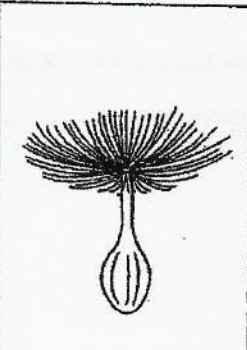
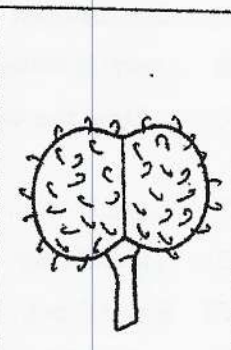
			
(1) Method S	Method R	Method T	Method S
(2) Method T	Method S	Method S	Method R
(3) Method R	Method S	Method T	Method R
(4) Method R	Method R	Method R	Method T

12. The diagram shows an experimental set-up with a water plant inside a wooden box.

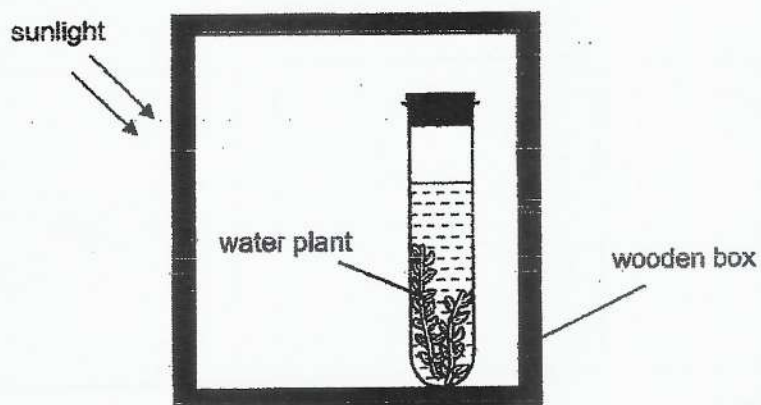

Which changes are likely to take place in the set-up after the wooden box is removed?

- A stomata open
  - B starch is made as the plant receives light
  - C bubbles are observed around the water plant
- (1) A and B only  
(2) A and C only  
(3) B and C only  
(4) A, B and C

13. Mr Lee tested four antibiotics, A, B, C and D, against bacteria M that causes throat infection. Antibiotics are medications that kill bacteria or slow down bacterial growth.

4 set-ups of bacteria M were prepared. Each antibiotic was added to the bacteria at a different time. Mr Lee observed and recorded the effect each antibiotic has on bacteria M as shown in the graphs below.

Based on the results given, which antibiotic is most effective in killing bacteria M?

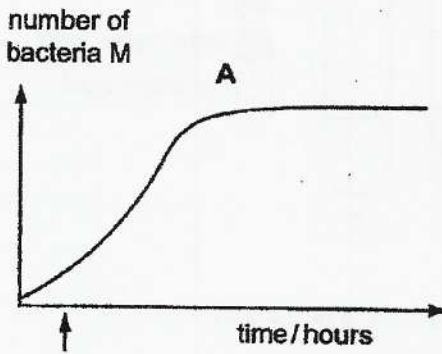

(1)

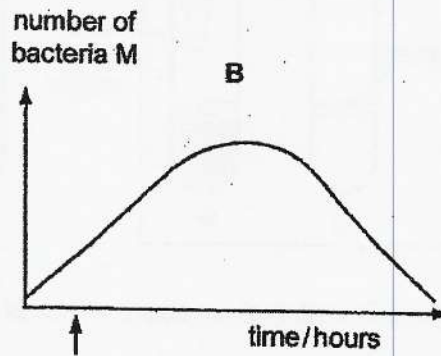

(2)

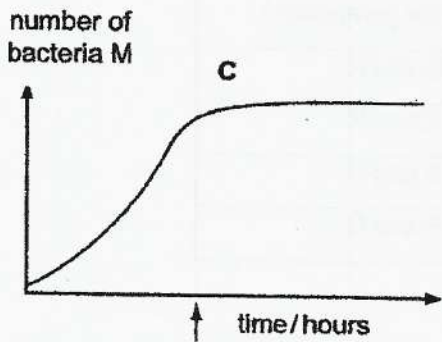

(3)

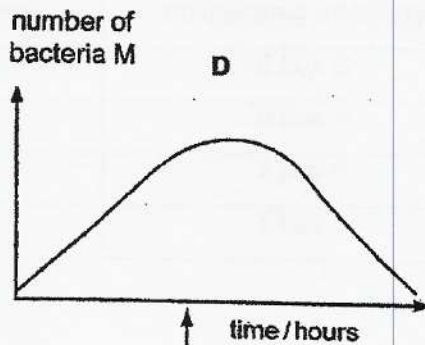

(4)

Key

↑ time at which antibiotic was added

14. Mina set up an experiment as shown below. Each glass tube contains identical seeds placed on cotton wool.

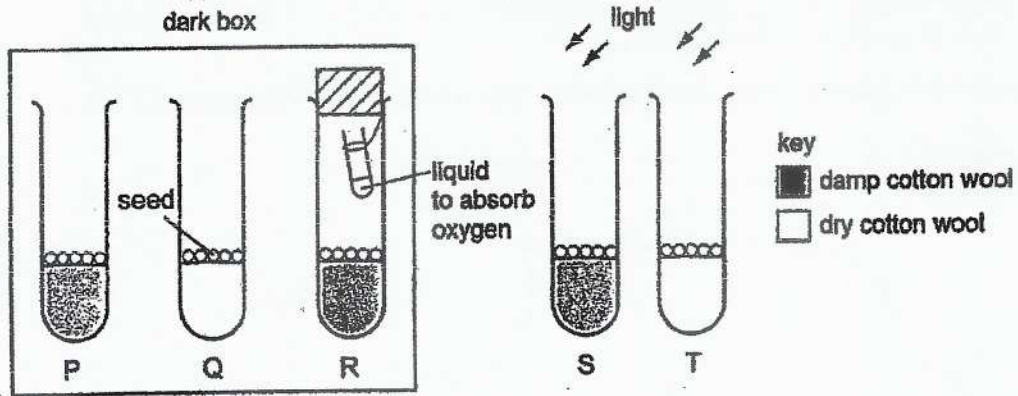

Based on the information given above, which of the following is correct?

Glass tubes to be compared		
	to find out whether light is needed for germination	to find out whether oxygen is needed for germination
(1)	Q and S	Q and R
(2)	P and S	P and R
(3)	R and T	S and R
(4)	S and T	P and Q



15. The diagram shows some stages in the human reproduction process.

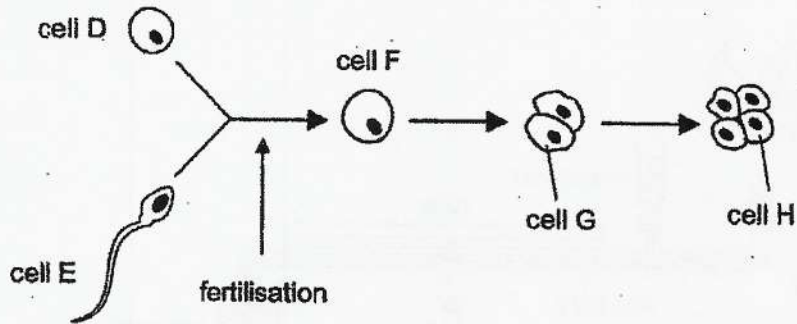

Based on the information given above, which of the following is correct?

Where cells are produced		Cells that are likely to have the same genetic information
Cell D	Cell E	
(1) ovule	ovary	D and E
(2) ovary	penis	F and G
(3) ovule	testis	D and F
(4) ovary	testis	G and H

16. The diagram shows an experimental set-up that is used to measure how quickly water is taken in by a leafy shoot.

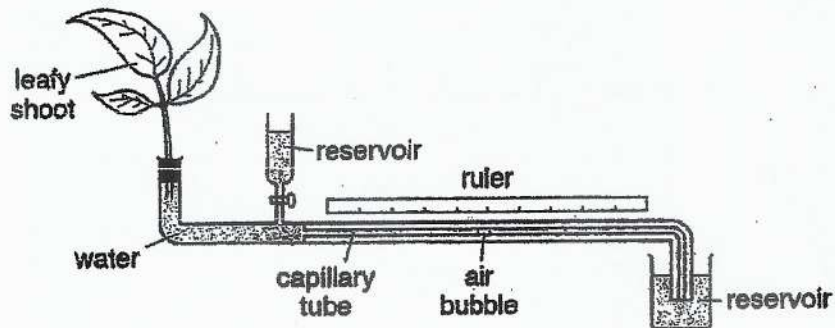

The distance moved by the air bubble to the left (←) in 10 minutes was recorded. The table below shows the results.

conditions	distance moved in 10 minutes (mm)
cool, dry air	7
cool, damp air	5
warm, dry air	45
warm, damp air	12

Which of the following conditions cause the fastest intake of water by the shoot?

- (1) cool, dry air
- (2) cool, damp air
- (3) warm, dry air
- (4) warm, damp air

17. The diagram shows an experiment set up by Melvyn to investigate photosynthesis. The plant has leaves that are green in the middle and white round the edges.

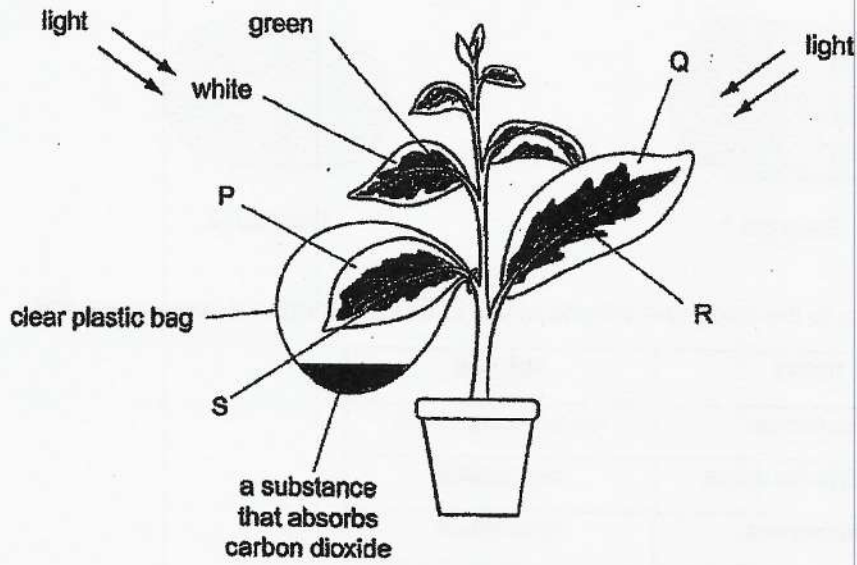

Based on the information given above, which of the following about leaf areas P, Q, R and S is correct?

leaf areas that did not absorb		
light only	carbon dioxide only	both light and carbon dioxide
(1) R	P	S
(2) Q	R	P
(3) P	S	R
(4) Q	S	P

18. Diagram 1 shows a piece of foam rubber that contains many tiny holes.  
Diagram 2 shows the same piece of foam rubber after it has been compressed.

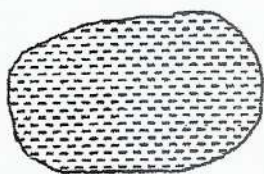

Diagram 1

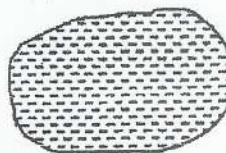

Diagram 2

What happens to the mass and volume of the foam rubber when it is compressed?

	mass	volume
(1)	decreases	remains the same
(2)	remains the same	decreases
(3)	decreases	decreases
(4)	remains the same	remains the same

19. Water exists in three states.

Which of the following changes of state can occur when water gains heat?

- A It changes from gas to solid.
- B It changes from liquid to gas.
- C It changes from gas to liquid.
- D It changes from solid to liquid.

- (1) A and C only
- (2) A and D only
- (3) B and D only
- (4) A, B and C only



20. Diagram A shows a measuring cylinder, containing some water, on an electronic balance.

Diagram B shows the same set-up with a stone added to the water.

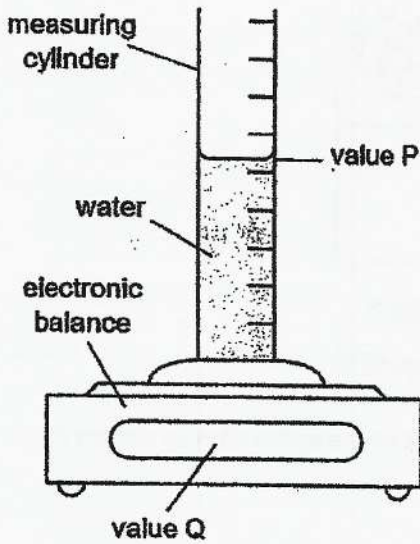

Diagram A

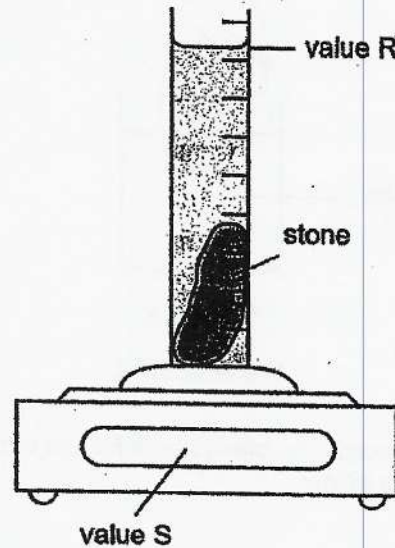
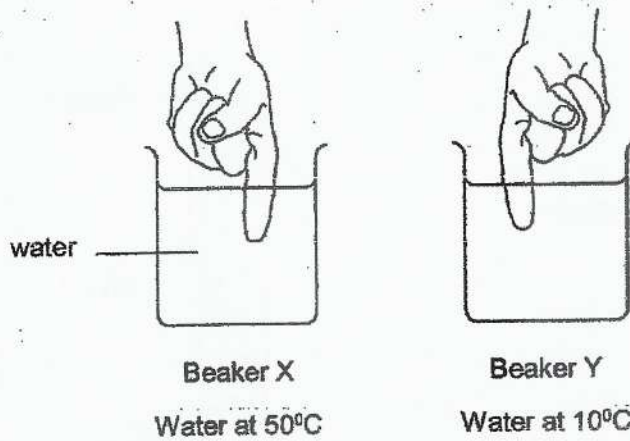

Diagram B

Which of the following is correct?

	To find the volume of the stone, we find the difference between the values of	To find the mass of the stone, we find the difference between the values of
(1)	Q and S	P and R
(2)	P and Q	Q and R
(3)	P and R	Q and S
(4)	Q and R	P and Q

21. Chen Ping placed one left finger into beaker X and one right finger into beaker Y as shown in the diagrams below.



After 30 seconds, he placed both fingers into beaker Z at the same time as shown in the diagram below.

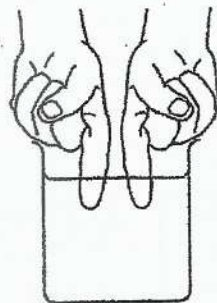

Beaker Z with water at 30°C

What would Chen Ping feel in each of his fingers?

	finger from beaker X dipped into beaker Z	finger from beaker Y dipped into beaker Z
(1)	warm	cold
(2)	cold	cold
(3)	cold	warm
(4)	warm	warm

22. Susie cooked sausages on a barbecue grill. She uses charcoal as the fuel for the barbecue.

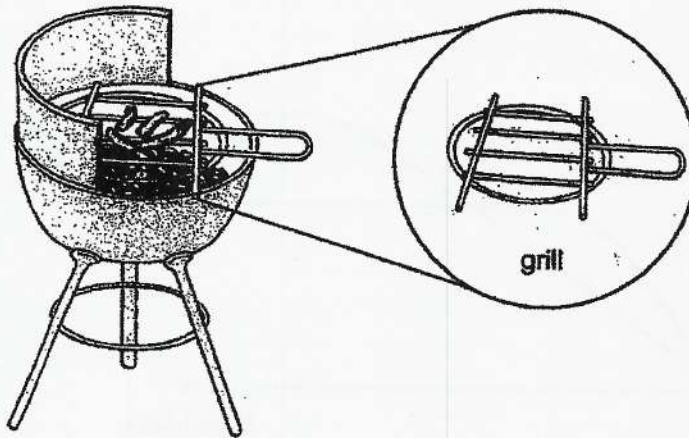

The grill of the barbecue is made of steel as shown in the diagram above.

Based only on the information given, which of the following properties make steel a suitable material for the grill?

- A It conducts heat well.
  - B It conducts electricity well.
  - C It has a high melting point.
- (1) A and B only  
(2) B and C only  
(3) A and C only  
(4) A, B and C

23. Equal masses of two different liquids, J and K, are heated using the same heater.

The graph shows how the temperature of each liquid changes with time.

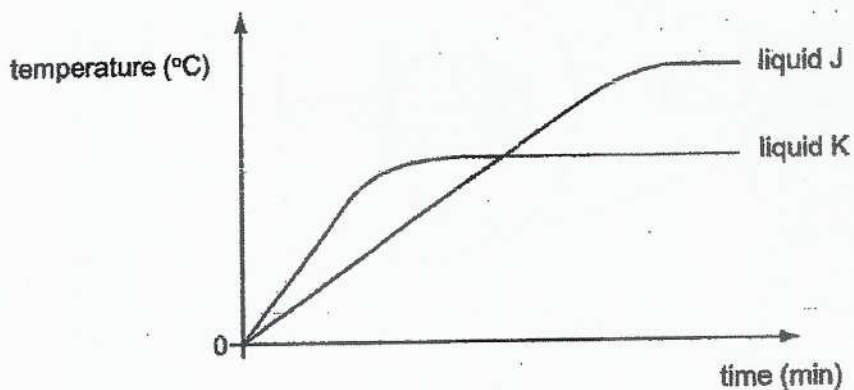

Based on the graph shown above, what can be concluded about liquids J and K?

- (1) Liquid J starts to boil sooner than liquid K.
- (2) Liquids J and K have the same boiling point.
- (3) Liquid J has a higher boiling point than liquid K.
- (4) Liquid K has a higher freezing point than liquid J.



24. A rod is made up of metal and wood joined together as shown below.

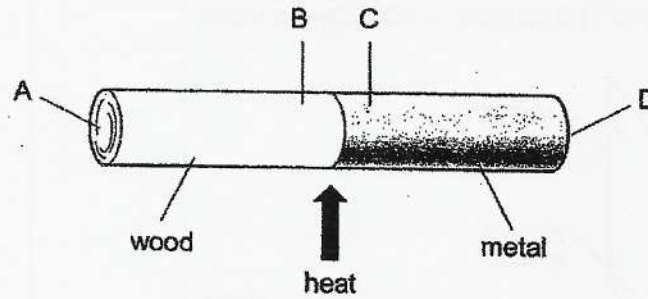

After the rod is heated at the centre for one minute, where would the highest and lowest temperature be?

	Highest temperature	Lowest temperature
(1)	B	A
(2)	B	D
(3)	C	D
(4)	C	A

25. Rahim wanted to find out how the distance,  $d$ , of an object from the light source affects the height of its shadow casted on the screen. He uses the experimental set-up shown below. The diagram is not drawn to scale.

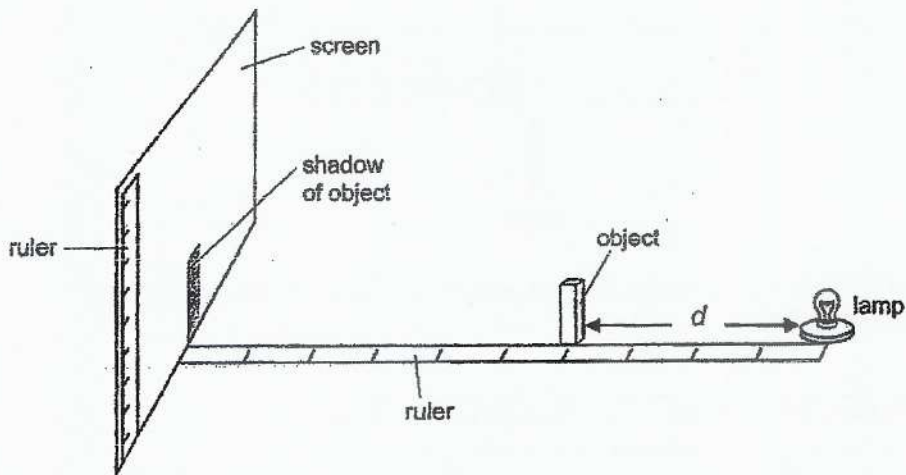

The diagram below shows the shadow formed when  $d$  is 15 cm.



Based on the information given, which of the following is not possible?

Size of shadow

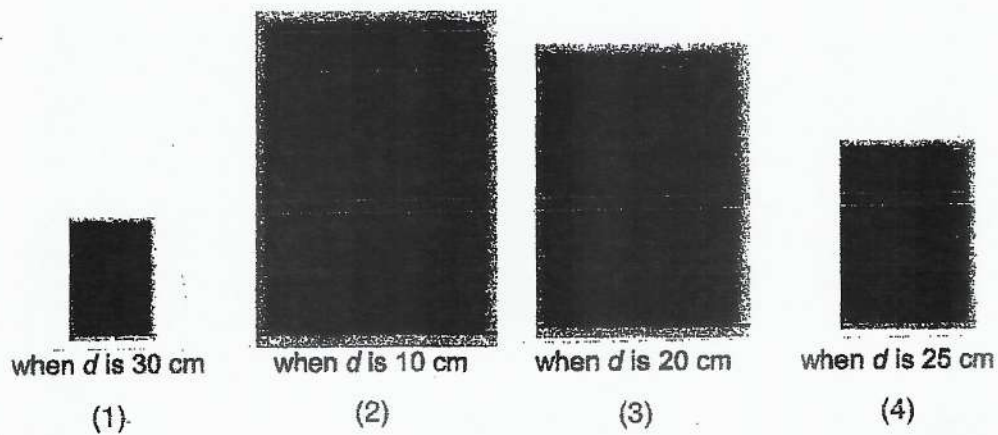

26. Four students were asked to draw a circuit showing three bulbs in parallel, a battery, and a switch that controls all three bulbs.

Which student has drawn the circuit correctly?

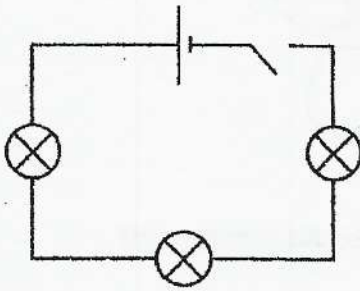

(1)

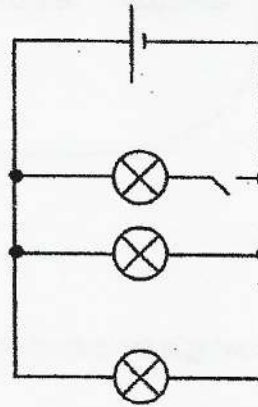

(2)

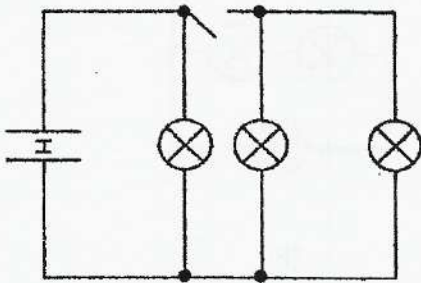

(3)

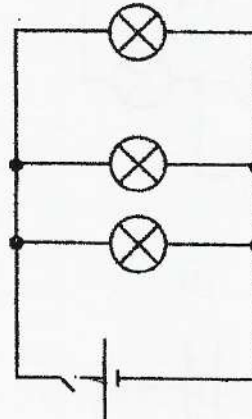

(4)

27. Ram sets up a circuit using two batteries and three bulbs as shown.

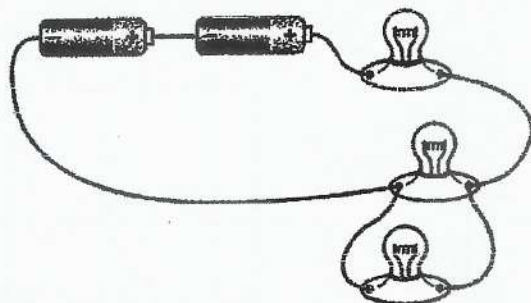

Which of the following is the correct circuit diagram for this arrangement?

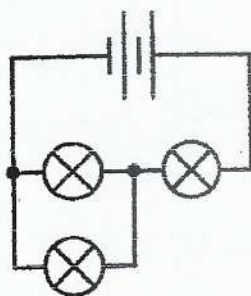

(1)

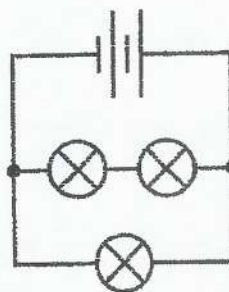

(2)

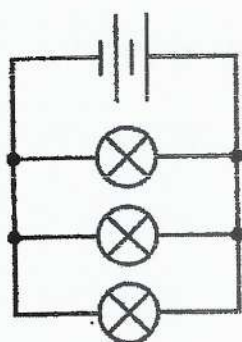

(3)

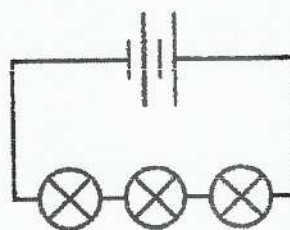

(4)



28. Jenny arranged three similar iron bars on a wooden table as shown below.

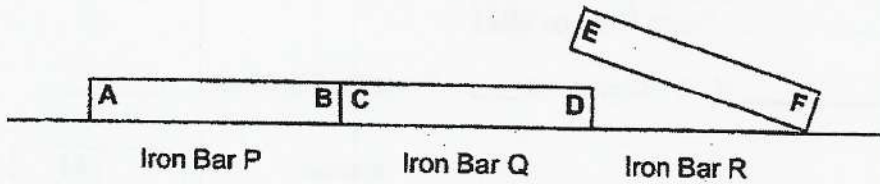

End F of iron bar R was brought close to each end of the other two iron bars. Based on the information given, which of the following results is possible?

Result when end F was brought near				
	End A	End B	End C	End D
(1)	attract	repel	attract	repel
(2)	attract	attract	repel	attract
(3)	repel	repel	repel	attract
(4)	repel	attract	attract	repel

End of Booklet A

Henry Park Primary School  
Primary Six Science  
Term Review 2021

Name: \_\_\_\_\_ ( ) Class: 6 \_\_\_ Parent's Signature: \_\_\_\_\_

Booklet B (44 marks)

Marks:

	44
--	----

For questions 29 to 40, write your answers in the space provided.

The number of marks available is shown in brackets [ ] at the end of each question or part question.

29. Sam and Melanie were standing outdoors on either side of a wall during the day as shown in the diagram below.

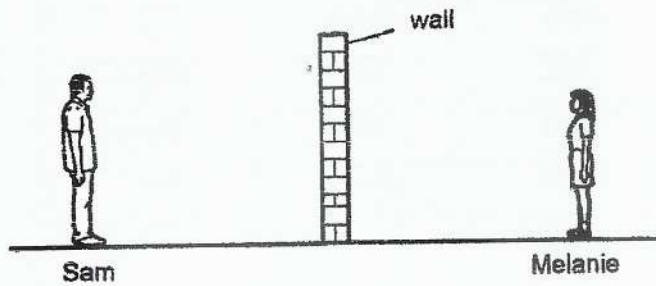

Sam was not able to see Melanie from where he was standing.

[2]

Explain why.

---

---

---

30. Ben investigated a toy shown in the diagram below.

He noticed the following about the toy.

- the toy has two similar woodpeckers, P and Q
- each woodpecker is attached to a wooden ring by a spring
- a metal rod passes through the wooden rings
- the woodpeckers have different masses
- the springs are identical

When a woodpecker is pulled back and released, it vibrates and moves down the metal rod.

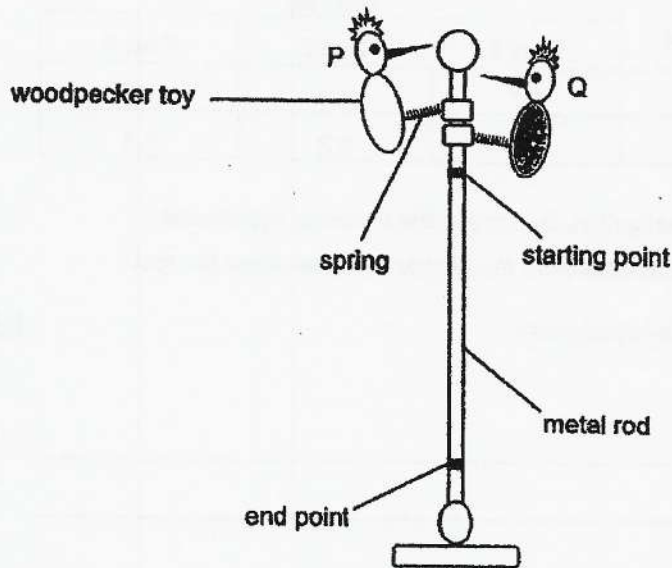

Ben carried out the following steps to investigate the toy.

- i. measure the mass of woodpecker P
- ii. move woodpecker P to the starting point and release it
- iii. record the time it takes for woodpecker P to reach the end point
- iv. repeat the test twice

He used the same method to test woodpecker Q.

(a) Based on the information given, state the aim of Ben's investigation.

[1]

Question 30 continued

- (b) Explain why it is important to mark out the starting and end points on the rod. [1]

---



---

The table shows Ben's results.

Woodpecker	Mass (g)	Time (s)		
		Test 1	Test 2	Test 3
P	9	4.7	4.3	4.5
Q	5	8.3	8.3	8.1

Before carrying out his investigation, Ben made the following hypothesis.  
*'The larger the mass of the woodpecker, the slower it moves down the rod.'*

- (c) Do Ben's results support his hypothesis? [1]

Explain your answer.

---



---



---

- (d) Besides repeating the experiment a number of times, what can Ben do to get more reliable results? [1]

---



---



31. Mini was boiling some tap water in a kettle as shown below.  
 The kettle is on top of an electronic balance which measures the mass of the boiling water.

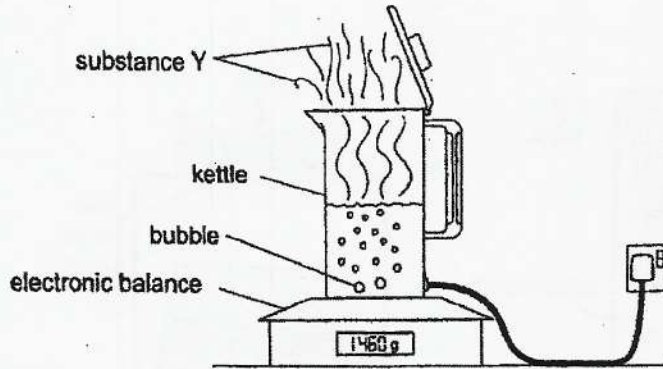

The mass of the tap water is measured at the start and 15 minutes later, while the water is boiling steadily.

- (a) The mass of water decreased by 25g over the 15 minutes. Explain why. [1]

---



---

- (b) The water boils for a long time. There are bubbles within the boiling water. Substance Y is observed just above the surface of the boiling water. [1]

- (i) State what substance Y is. \_\_\_\_\_  
 (ii) State what is inside each bubble. \_\_\_\_\_

- (c) On the diagram below, draw a line graph to show what happens to the temperature of the tap water as it was heated. [1]

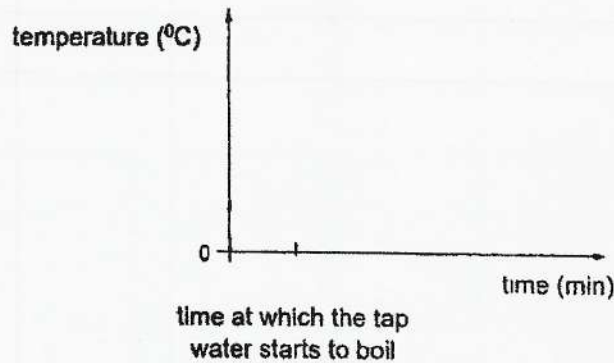

Question 31 continued

Mini bought a coffee drink sold in a self-heating can. Diagram 1 shows parts of the self-heating can.

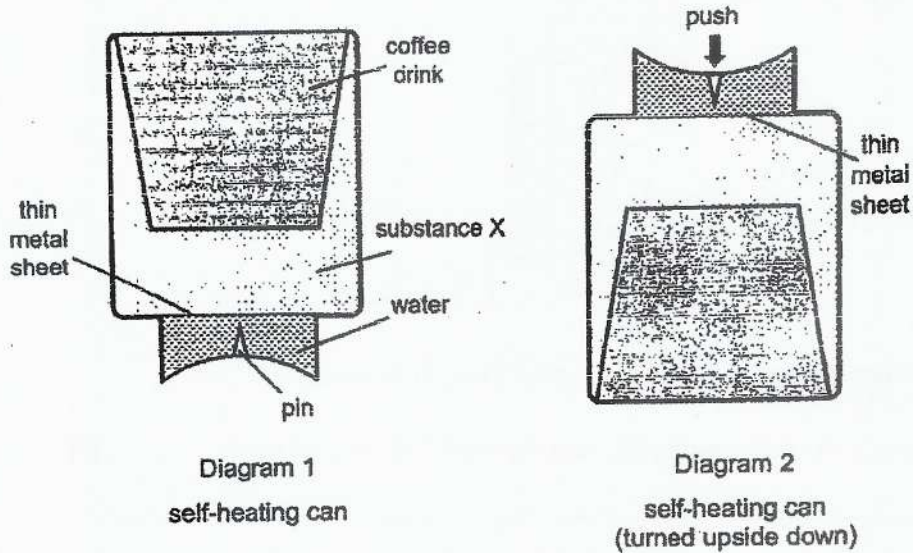

Diagram 2 shows the can after Mini has turned it upside down to push the pin through the thin metal sheet.

When substance X mixes with water, heat is produced.

- (d) Based on the information given, explain how pushing the pin down enables the coffee drink to become hot before Mini could consume it. [2]

---



---



---

32. Victoria installs an electrical circuit in her toy house so that a lamp can be switched on using either switch 1 at the bottom of the stairs or switch 2 at the top of the stairs as shown in the diagram below. The lamp is not lit.

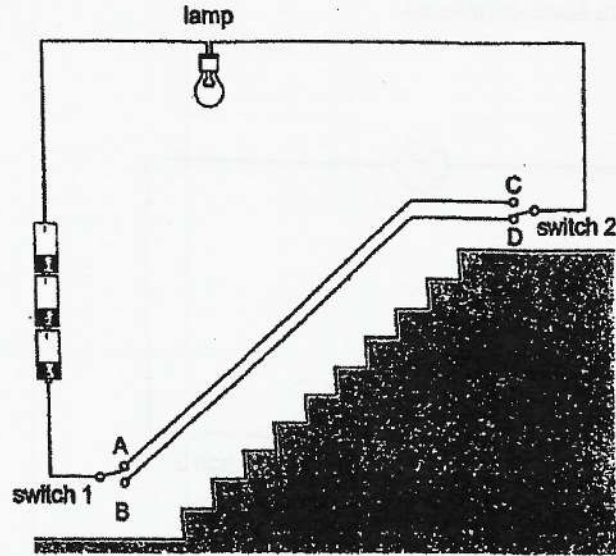

The diagram below shows the electrical circuit in Victoria's toy house.

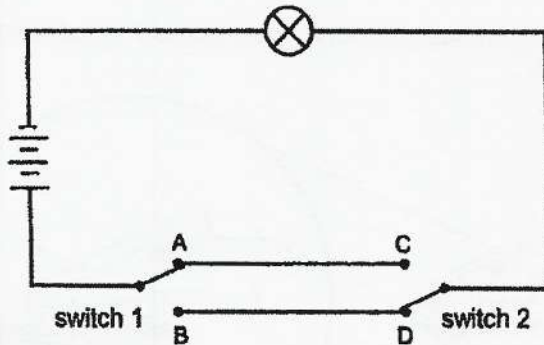

- (a) (i) When switch 1 is in position A, at which position (C or D) should switch 2 be in so that the lamp is lit? [1]

\_\_\_\_\_

- (ii) When switch 2 is in position D, at which position (A or B) should switch 1 be in so that the lamp is lit?

\_\_\_\_\_

Question 32 continued

Victoria wants to connect another similar lamp with the first lamp. She wants both lamps to have the same brightness.

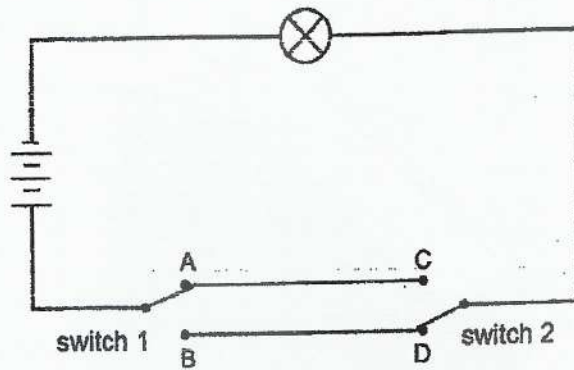

- (b) On the circuit diagram shown above, draw the second lamp so that both lamps have the same brightness when they are lit. [1]

The diagram below shows an electric circuit with two identical batteries and bulbs. The switch is open.

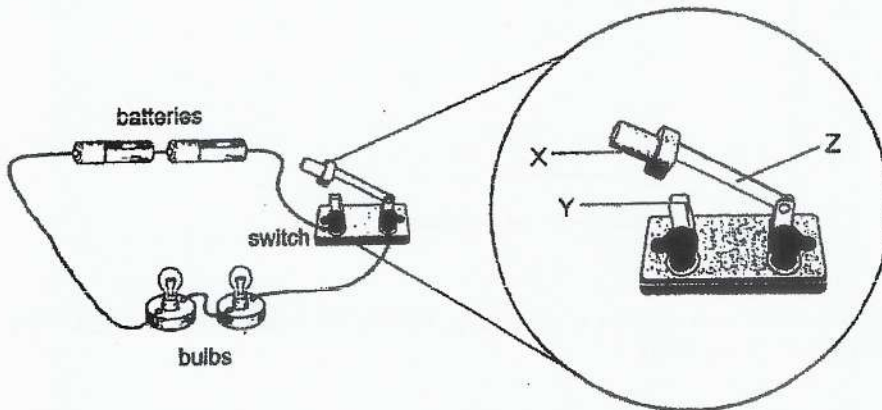

- Study the parts, X, Y and Z, of the switch shown above.
- (c) Which parts of the switch are made of a material that conducts electricity? [1]



33. Mr Lee uses a cold drink chiller to cool a bottle of warm soft drink. The metal chiller is inserted into the bottle as shown in the diagram.

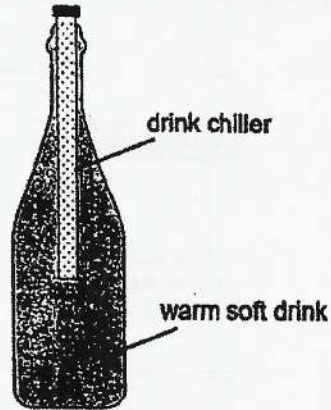

- (a) Mr Lee had to keep the metal chiller in the freezer for at least 2 hours before using it. [1]

Explain why.

---

---

- (b) As the metal chiller became warmer, Mr Lee observed an increase in the number of water droplets forming on the outside of the soft drink bottle. [2]

Explain why.

---

---

---

34. Wahid made two similar electromagnets. He changed the material of the rod he used in each set-up as shown below. He used paper clips to test the strength of each electromagnet. He switched on the power supply in both circuits.

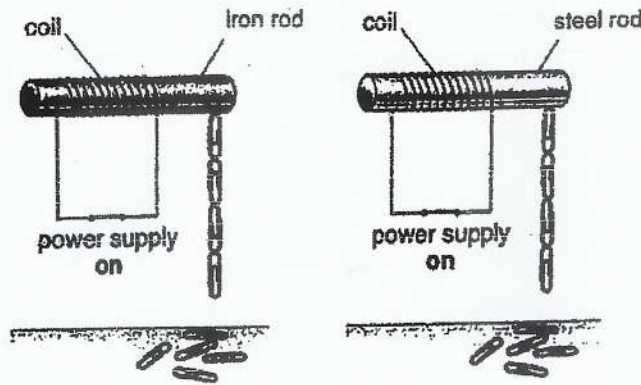

(a) What conclusion can be made about the strength of both electromagnets? [1]  
How did you arrive at your conclusion?

---



---

Wahid switched off the power supply in both circuits. What he observed is shown in the diagrams below.

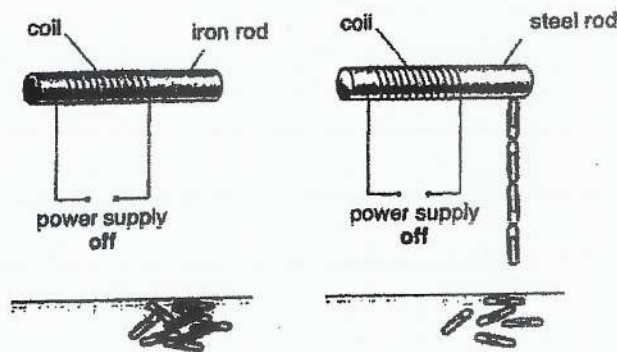

(b) Based on the information given, explain why iron rods are used, rather than steel, for electromagnets. [1]

---

## Question 34 continued

Wahid used an electromagnet to build a simple lock as shown below.

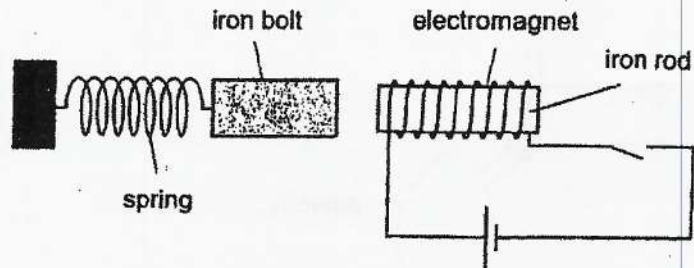

When the switch is closed, the iron bolt is pulled towards the electromagnet to lock the door. When the switch is open, the spring pulls the iron bolt away from the electromagnet, unlocking the door.

- (c) Based on the results of Wahid's experiment, explain why he did not use a steel rod to make the electromagnet for the lock. [1]

In a scrapyards, old machines such as motor vehicles are destroyed but some of their useful parts are saved for recycling. Wahid observed that an electromagnet was used to lift a car in a scrapyards as shown.

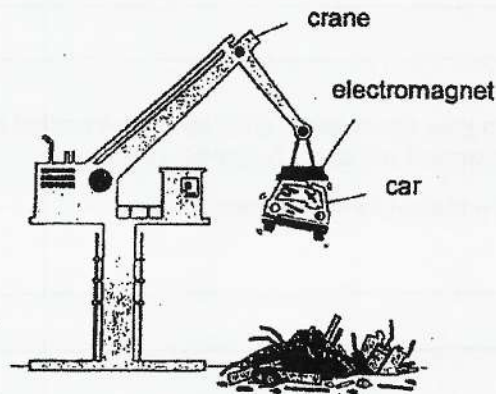

- (d) Explain why it is better to use an electromagnet rather than a permanent magnet in the scrapyards. [1]

35. The diagrams show part of the human digestive system.

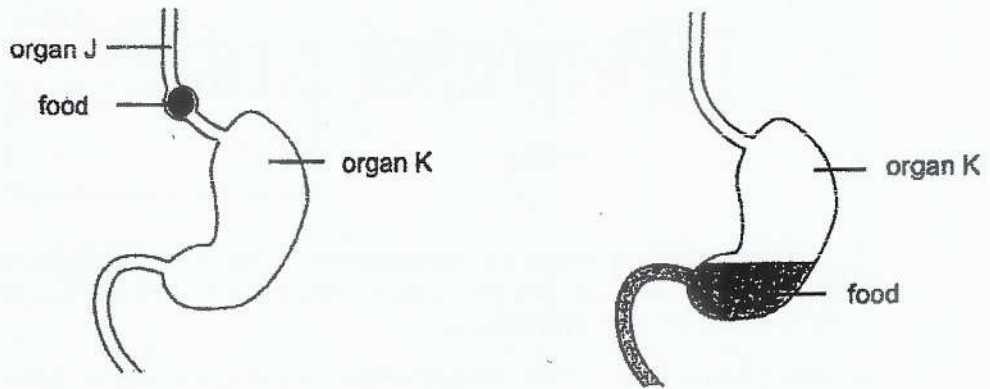

The diagrams show some food before it enters organ K and the same food leaving organ K four hours later.

(a) State the function of organ J. [1]

---

---

(b) Based on your observation, state how the food that entered organ K has changed when it left organ K four hours later. [2]

Suggest a reason for this change.

---

---

---



36. Gillian investigates the effect of light intensity on the rate of photosynthesis.

The test-tube is full of water at the start. The apparatus is placed on a table in a room for a few hours. Diagram A shows what has happened after a few hours.

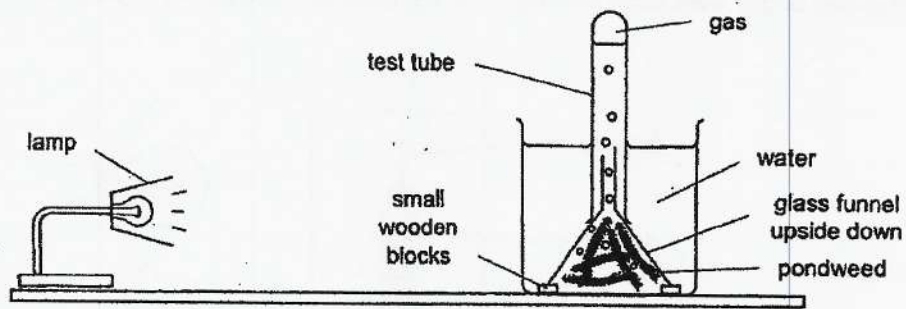

Diagram A

Gillian repeated the experiment by moving the lamp closer to the pondweed as shown in diagram B. The apparatus is left for the same length of time as the previous experiment.

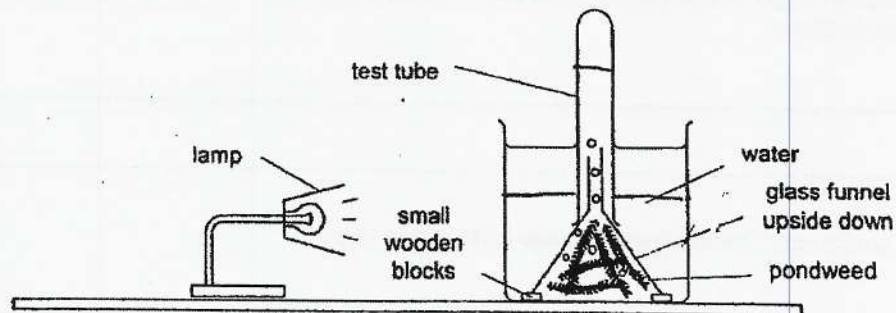

Diagram B

(a) In diagram B, draw a line to suggest the new water level in the test-tube. Explain your answer.

[1]

---



---



---

Question 36 continued

Gillian investigated the effect of light intensity on the rate of photosynthesis using another water plant. She set up the experiment shown below in a dark room and used a bright lamp.

Bubbles of gas were seen coming out of the plant as it carried out photosynthesis.

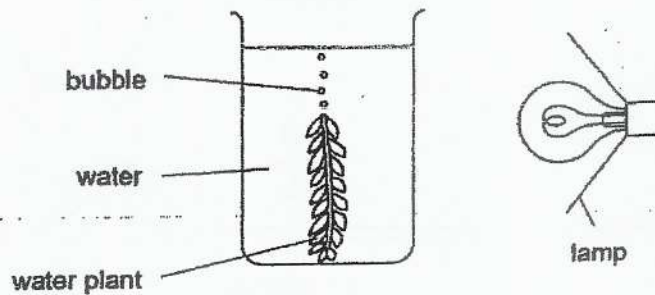

Five minutes after setting up the experiment, she counted the number of bubbles given off in one minute. She repeated the experiment by moving the lamp to different distances from the plant.

- (b) Explain why the plant was left for five minutes at each light intensity before counting the bubbles. [1]

---

---

- (c) Explain why Gillian placed the set-up in a dark room. [1]

---

---

- (d) Gillian has to keep the surrounding temperature of the water plant the same throughout the experiment. [1]

Suggest one way she could do this.

---

---

Question 36 continued

- (e) Gillian decided to change her experiment by adding water snails to the set-up as shown below.

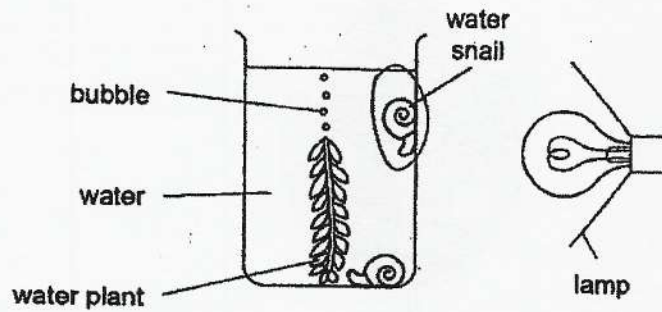

She observed that the number of bubbles given off by the water plant in one minute increased. [1]

Explain why.

---

---

37. Study the diagram of the leaf shown below.

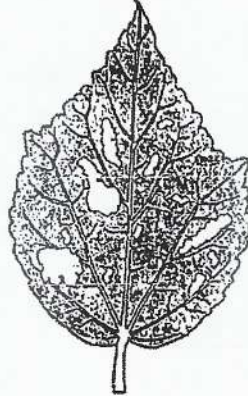

- (a) State the main function of a leaf. [1]

---

The leaf is damaged by the larva of an insect that feeds on it.

- (b) Explain how the growth of the plant may be affected if most of its leaves were damaged in this way. [1]

---



---

The diagram shows one of the ways in which plant B reproduces. It grows young plants from its leaves.

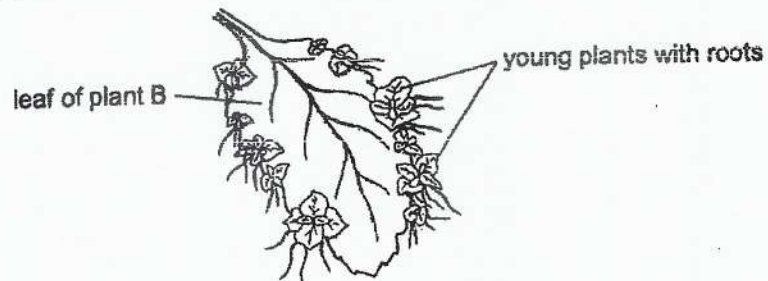

- (c) Explain why reproducing in this way, rather than by seeds, can be an advantage to plant B. [1]

---



---



38. The diagram shows two flowers found on the same type of plants.

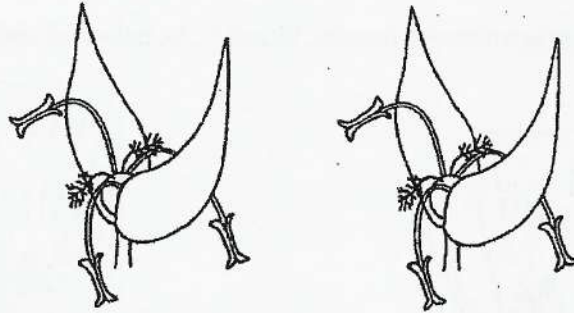

Flower C

Flower D

(a) On the diagram, draw an arrow to show how pollination occurs from flower C to flower D. [1]

The diagrams below show flowers B and C from two different types of plants.

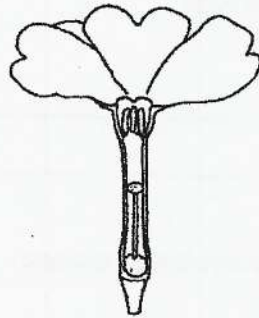

Flower B

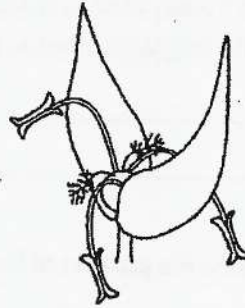

Flower C

(b) Which flower is more likely to be pollinated by insects? [1]  
Use the diagrams given to explain your answer.

---

---

Question 38 continued

The diagram shows two different flowers, W and X, found on the same plant.

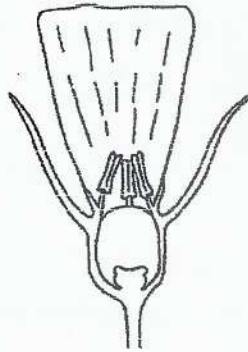

Flower W

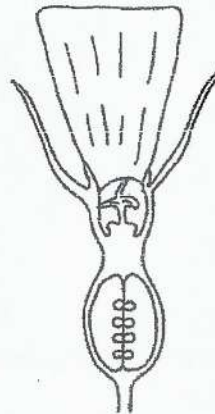

Flower X

- (c) Which flower, W or X, is likely to develop into a fruit? [1]  
Use the diagrams given to explain your answer.

---

---

- (d) Describe the process of fertilisation taking place in flowering plants. [1]

---

---

39. Pamela wanted to find out how much oxygen different types of animals take during a fixed time. She used small animals, P and Q, for her experiment. She used the experimental set-up shown below for her experiment.

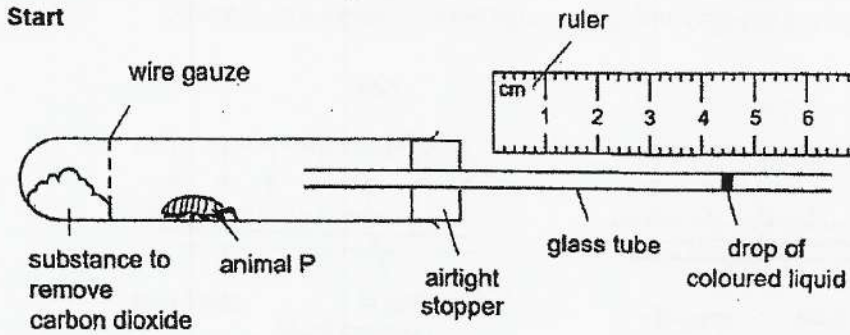

The diagram below shows the result for animal P after 30 minutes.

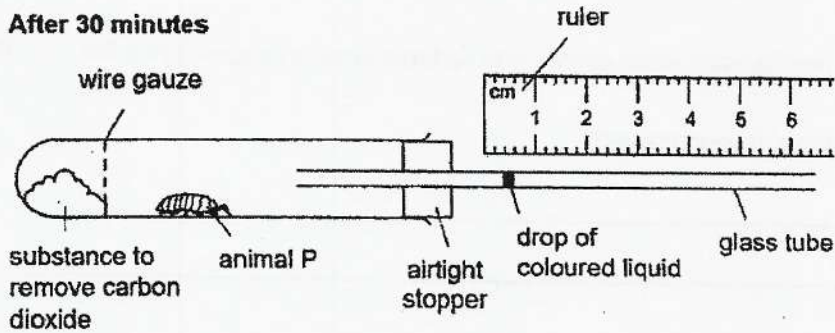

- (a) Explain why the coloured liquid moves towards the animal P during the experiment. [2]

---



---



---

- (b) Suggest what would happen to the drop of coloured liquid if the stopper is not airtight. [1]

---



---

Question 39 continued

Pamela repeated the experiment with animal Q. The diagrams show the positions of the coloured liquid at the start and at the end of the experiment with animal Q.

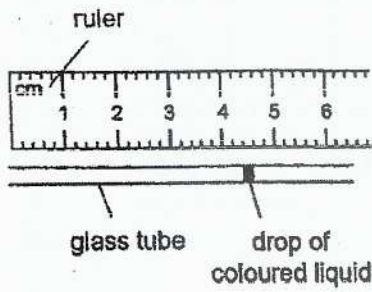

At the start

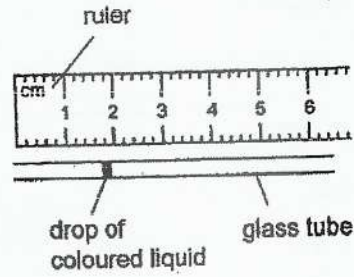

After 30 minutes

- (c) Based on the results, state which animal, P or Q, takes in more oxygen during the experiment. [1]

How did you arrive at your answer?

---

---

- (d) Suggest a suitable control set-up for this experiment. [1]

---

---



40. The diagram shows the human circulatory system. The arrows show the direction of blood flow.

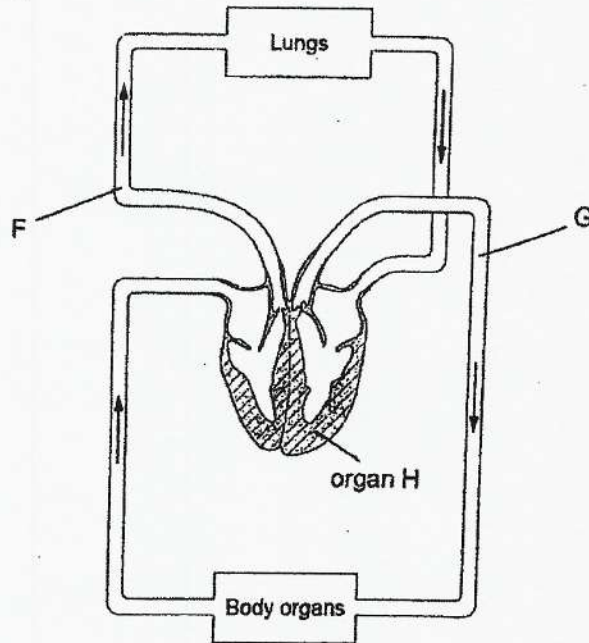

- (a) Name organ H.

[1]

---

- (b) Which blood vessel, F or G, carries blood containing a smaller amount of oxygen?

[1]

Explain your answer.

---



---



---



**SCHOOL: HENRY PARK PRIMARY SCHOOL**

**SUBJECT: SCIENCE**

**LEVEL: PRIMARY 6**

**PAPER: TERM REVISION (2021)**

**BOOKLET A**

Q1	Q2	Q3	Q4	Q5	Q6	Q7	Q8	Q9	Q10
2	2	4	3	3	1	4	2	1	1
Q11	Q12	Q13	Q14	Q15	Q16	Q17	Q18	Q19	Q20
3	2	4	2	4	3	4	4	3	3
Q21	Q22	Q23	Q24	Q25	Q26	Q27	Q28		
3	3	3	1	3	4	1	2		

**BOOKLET B**

- Q29.** The wall is opaque and higher than Sam. Light only travels in a straight line, so Sam cannot see Melanie from where he was standing.
- Q30.** a) To find out if the mass of the woodpecker would affect how fast it takes for it to reach the end point.
- b) Mark will be able to know where to start the woodpecker and when to let it stop.
- c) No. Even though P is heavier than Q, P took a shorter time to move down the rod while Q took a longer time to do so.
- d) Add another woodpecker that is of a lighter mass than Q.
- Q31.** a) The water will be converted into substance Y and some of it will evaporate. The mass of the water will decrease by 25g as there is lesser water in the kettle.
- b) (i) Liquid
- (ii) Air

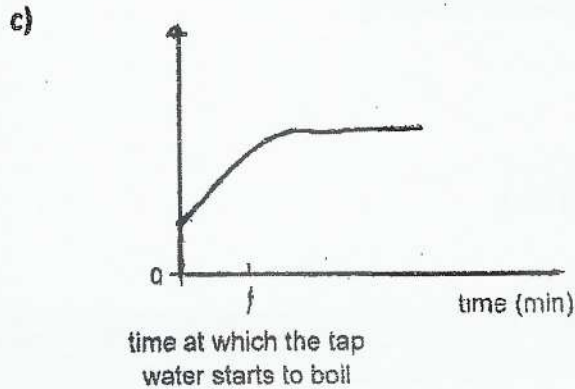

d) The pin would poke a hole in the thin metal sheet and the water will mix with substance X and heat is produced. The coffee drink gains heat from the mixture and it becomes hot.

Q32. a) (i) C

(ii) B

b)

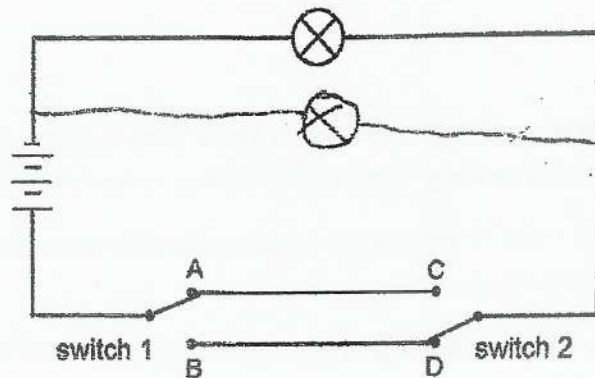

c) Y, Z

Q33. a) The metal chiller will lose heat to the colder air in the freezer, and it becomes cold.

b) The drink chiller will gain heat from the warm soft drink and it will gradually get warmer. The drink gets colder, causing the bottle to lose more heat to the cold drink and makes it colder. More hot water vapour surrounding the bottle then loses heat and condenses on the cooler surface of the bottle to form more water droplets.



- Q34. a) The strength of both rods are the same. When the power supply was turned on, both electromagnets had attracted the same number of paper clips.
- b) The iron rod did not attract any paper clips when the power supply was off. But the steel rod still attracted the paper clips even though the power supply was off.
- c) The steel rod did not lose its magnetism when the circuit was open. So the electromagnet would still attract the iron bolt when the circuit was open, allowing the door to remain locked.
- d) An electromagnet can lose its magnetism easily, allowing the crane to release the car easily.
- Q35. a) J allows food to pass through it and transports the food into organ K.
- b) The digested food leaving organ K is in liquid state, because the digestive juices in organ K broke down the solid food into simpler substances before it is transported into the next organ.

Q36. a)

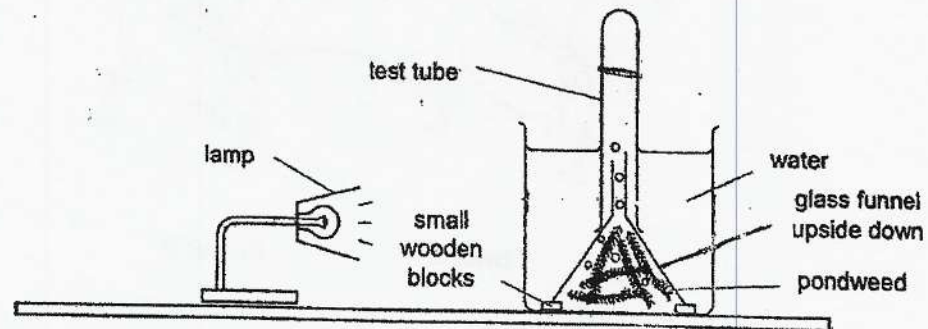

Diagram B

Light intensity increases as the lamp is brought closer to the pondweed. This increases the rate of photosynthesis of the pondweed, allowing more oxygen to be produced. The oxygen produced takes up space in the test tube, therefore increasing the water level.

b) The plant will be able to photosynthesise before it releases the bubbles.

- c) There will be no other light sources affecting the results of the experiment.
- d) Maintain the temperature of the water by adding cold water when the water gains heat from the lamp.
- e) The water snail produces carbon dioxide as it respire. The increased amount of carbon dioxide increases the rate of photosynthesis of the water plant, causing more bubbles to be produced.

Q37. a) it makes food for the plant.

b) There will be lesser chlorophyll for the plant to make food.

c) It can reproduce faster as it no longer needs to go through pollination.

Q38. a)

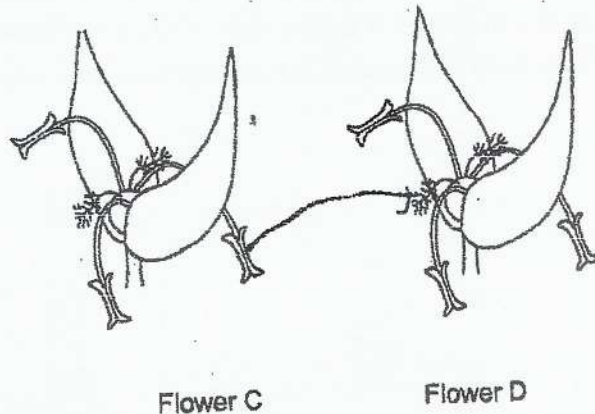

b) Flower B. The insects must go close to flower B to find food. By doing so, they carry the pollen grains from the anther to the stigma which is found inside the flower.

c) Flower X. It has a stigma where pollination takes place, and an ovary where fertilisation takes place.

d) The pollen grain that lands on the stigma enters the ovary through the pollen tube. The pollen grain then fuses with the egg that is found in the ovary and fertilisation occurs.

- Q39. a) Animal P takes in the oxygen present in the test tube. The air in the glass tube enters the test tube and takes up the empty space. This causes the coloured liquid to move towards animal P.
- b) It would remain at the same position.
- c) Animal P. The coloured liquid was closer towards the end of the tube as compared to the test tube for animal Q.
- d) The control set-up should not have any animal in the test tube.
- Q40. a) Heart
- b) F. The blood in F has passed through the body organs which take in oxygen carried by the blood.

