

SA2

--	--	--	--	--	--	--	--

SINGAPORE CHINESE GIRLS' SCHOOL (PRIMARY)

PRIMARY SIX PRELIMINARY ASSESSMENT 2021

NAME: _____ ()

DATE: 19 August 2021

CLASS: PRIMARY 6 SY / C / G / SE / P

Parent's Signature: _____

**SCIENCE
BOOKLET A**

28 questions

56 marks

Total time for Booklets A & B: 1 h 45 min

**DO NOT OPEN THIS BOOKLET UNTIL YOU ARE TOLD TO DO SO.
FOLLOW ALL INSTRUCTIONS CAREFULLY.**

Booklet A (56 marks)

For each question from 1 to 28, four options are given. One of them is the correct answer. Make your choice (1, 2, 3 or 4). Shade the correct oval (1, 2, 3 or 4) on the Optical Answer Sheet.

1. The diagram below shows the human respiratory system.

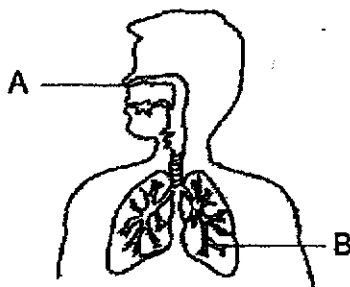

Which one of the following correctly states the functions of A and B during breathing?

	A	B
(1)	Transports oxygen and carbon dioxide around the body	Controls the breathing rate of the body
(2)	Controls the breathing rate of the body	Allows air to enter and leave the body
(3)	Moistens the air before it enters the body	Transports oxygen and carbon dioxide around the body
(4)	Allows air to enter and leave the body	Carries out gaseous exchange

2. Angeline placed 3 strips, Q, R and S, made of different materials into 3 beakers each containing 50ml of coloured water. She left the strips in the beakers and observed them after 10 minutes.

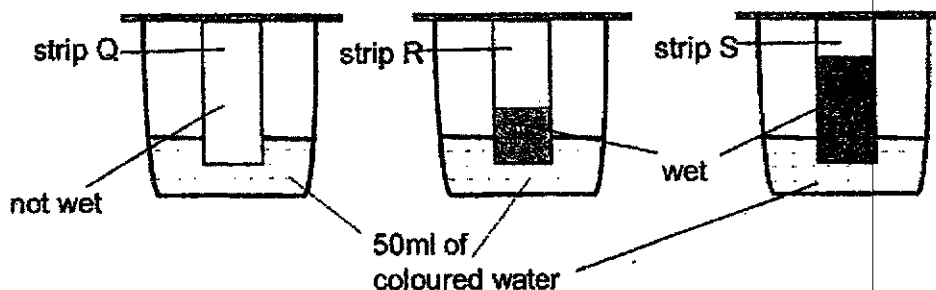

Based on her observations, Angeline wrote the following statements.

- A: Q is waterproof.
 B: R absorbed more water than S.
 C: R is the most water absorbent material.
 D: Q is suitable to make raincoats.

Which of the statements above are correct?

- (1) A and D only
 (2) B and C only
 (3) A, B and C only
 (4) A, C and D only

3. The diagram below shows 3 human body systems.

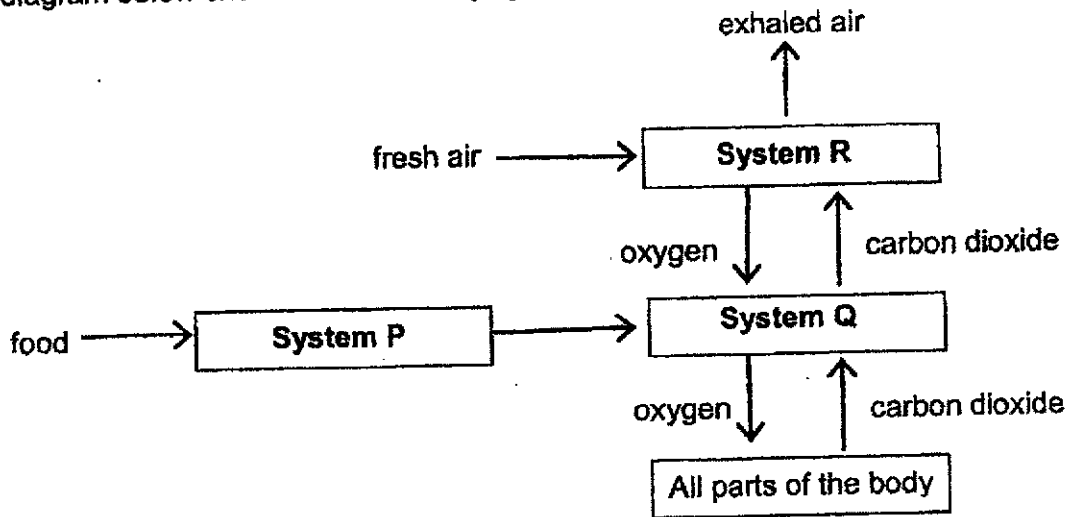

Which of the following correctly shows Systems P, Q and R?

	System P	System Q	System R
(1)	digestive	circulatory	respiratory
(2)	respiratory	digestive	circulatory
(3)	skeletal	digestive	circulatory
(4)	digestive	circulatory	skeletal

4. Jonathan identified 3 types of cells using the flowchart below.

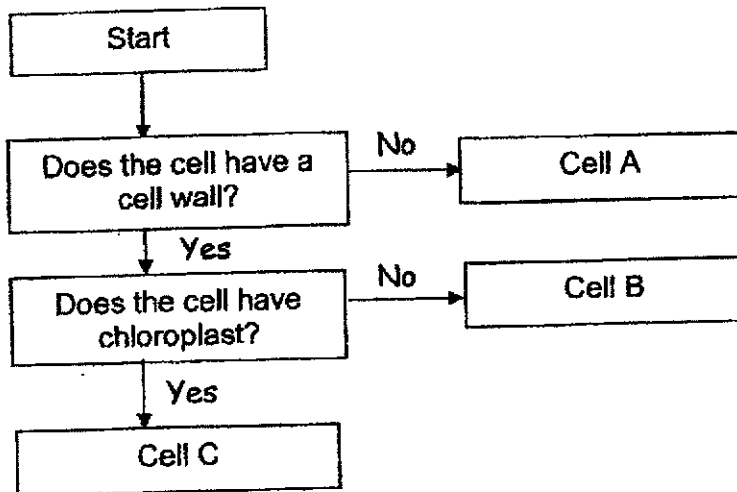

Which of the following correctly identifies Cell A, B and C?

	Cell A	Cell B	Cell C
(1)	Leaf cell	Flower cell	Cheek cell
(2)	Cheek cell	Root cell	Flower cell
(3)	Cheek cell	Root cell	Leaf cell
(4)	Root cell	Flower cell	Leaf cell

5. The diagram below shows stomata on the surface of a leaf.

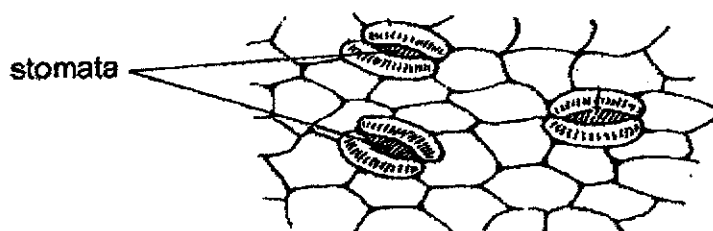

Which of the statements are true about stomata?

- A: They trap light for photosynthesis.
 B: They can be found on the underside of the leaf.
 C: They allow only carbon dioxide to enter the leaves.
 D: They allow gaseous exchange to take place with the surroundings.

- (1) A and C only
 (2) B and D only

- (3) A, C and D only
 (4) B, C and D only

6. Tannie hung different masses on 2 springs, A and B, one at a time. She recorded the length of the spring. Her results are shown in the graph below.

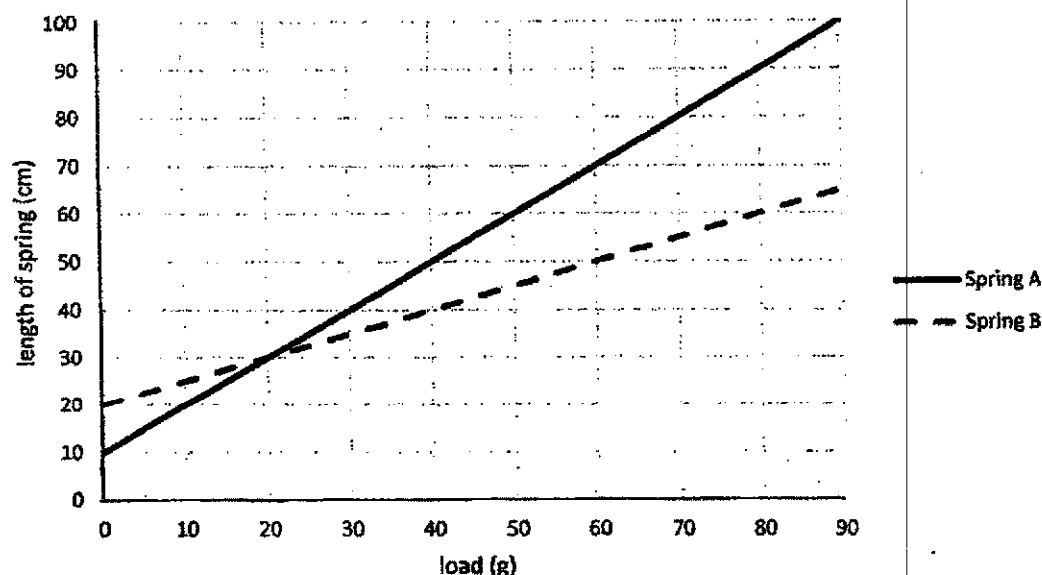

Which one of the following correctly represents the conclusion that Tannie can draw from this experiment?

- (1) Spring A is stiffer than spring B.
 (2) Spring B can be stretched less than spring A with the same load.
 (3) The original length of spring B is shorter than spring A.
 (4) The extension of both spring A and spring B is the same when load is 20g.

7. Ashley set up the experiment below. She poured 400ml of water into 2 identical containers, A and B. She placed a plant in container A. Then she poured a layer of oil on the surface of water in both containers. Both containers were left near an open window for 3 days. She recorded the amount of water in each container daily and showed the results in a bar graph.

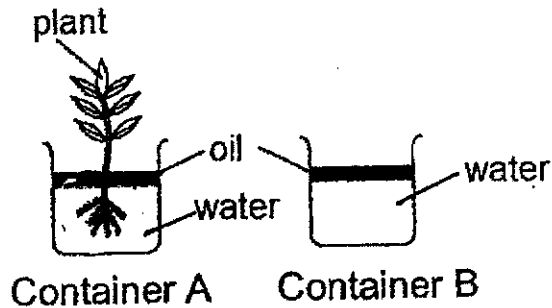

Based on the above experiment, which one of the following bar graphs shows the correct amount of water in each container at the end of each day?

(1) Amount of water (ml)

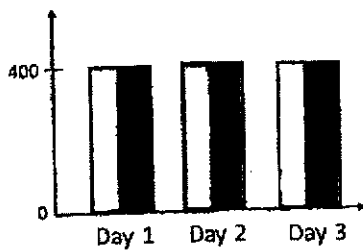

(3) Amount of water (ml)

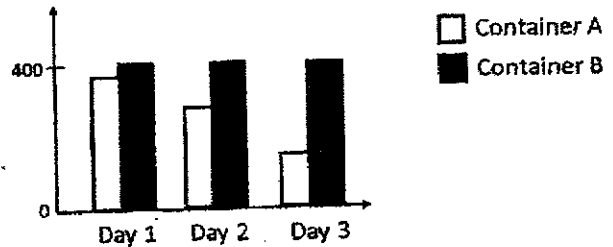

(2) Amount of water (ml)

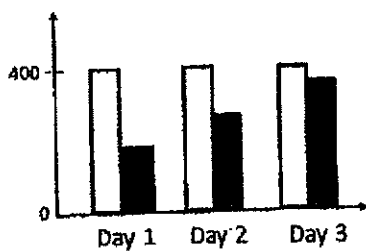

(4) Amount of water (ml)

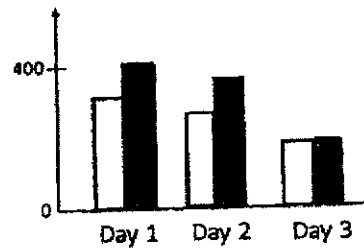

8. Which of the following object/s has/have gravitational force acting on it?

- A: A balloon rising into the air
- B: A man lying on the floor
- C: A stone rolling down the hill

- (1) A only
- (2) C only

- (3) A and C only
- (4) A, B and C

9. The graph below shows the amount of nitrogen, oxygen and carbon dioxide in the air that we breathe in.

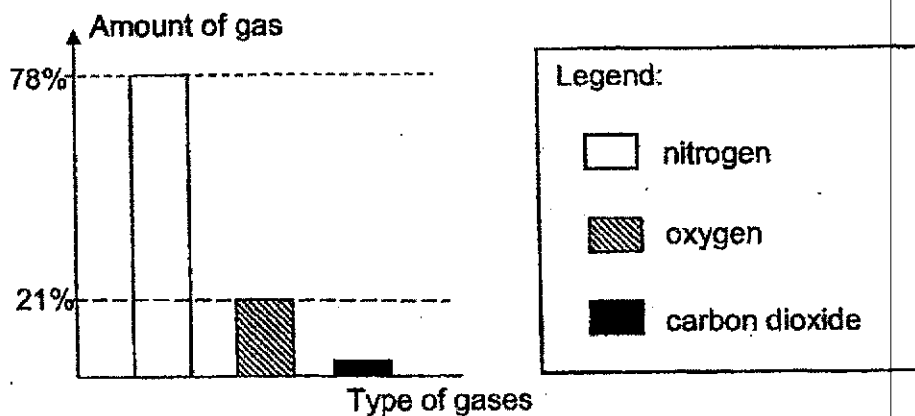

Which of the following graphs most likely shows the amount of these gases in the air that we breathe out?

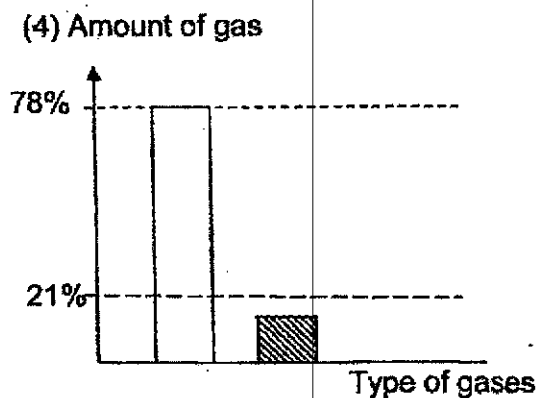
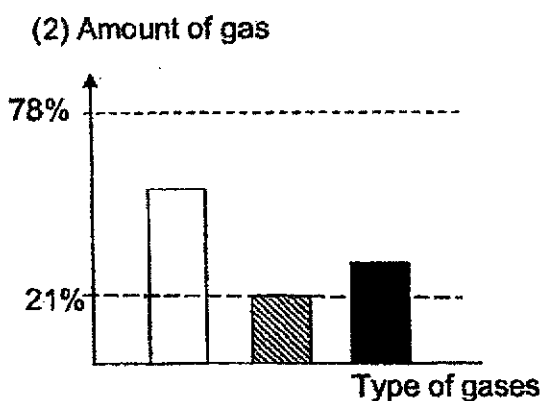
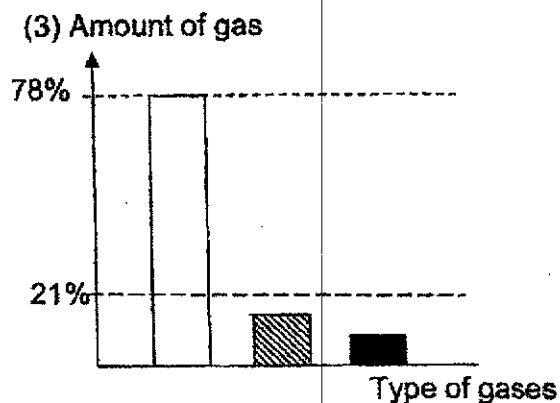
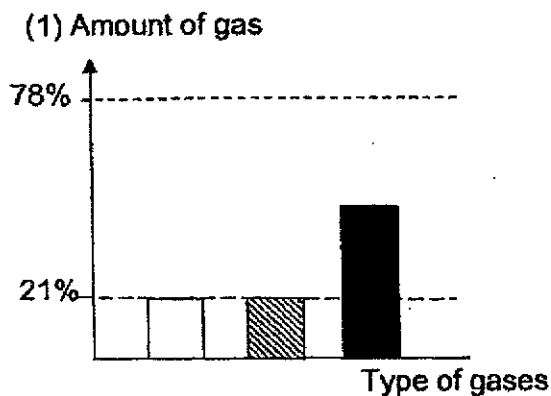

10. Michelle carried out an experiment to find out the conditions required for seed germination. She prepared 4 set-ups, A, B, C and D. Each set-up contained 10 seeds placed on a petri dish. Each set-up was exposed to different conditions.

She recorded her observations after a few days in the table below.

Set-up	Number of germinated seeds
A	0
B	0
C	10
D	10

John saw Michelle's table and guessed the conditions of each set-up. Which 2 of his guesses are correct?

Set-up	Conditions present (✓)		
	Warmth	Light	Water
A	✓		✓
B	✓	✓	
C		✓	✓
D	✓	✓	✓

- (1) A and C only
 (2) A and D only
 (3) B and C only
 (4) B and D only

11. The diagram below shows the movement of the substances X, Y and Z in a plant. Z is a substance that is given out by the plant.

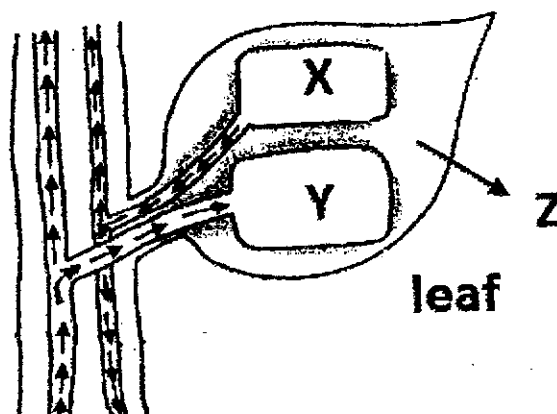

Which of the following shows the correct substances, X, Y and Z?

	X	Y	Z
(1)	water	sugar	water vapour
(2)	sugar	water	water vapour
(3)	water	sugar	water droplets
(4)	sugar	water vapour	water droplets

12. A boat is travelling towards an island. The boat encountered wind and water current during its journey to the island. The possible directions of wind and water current are shown below.

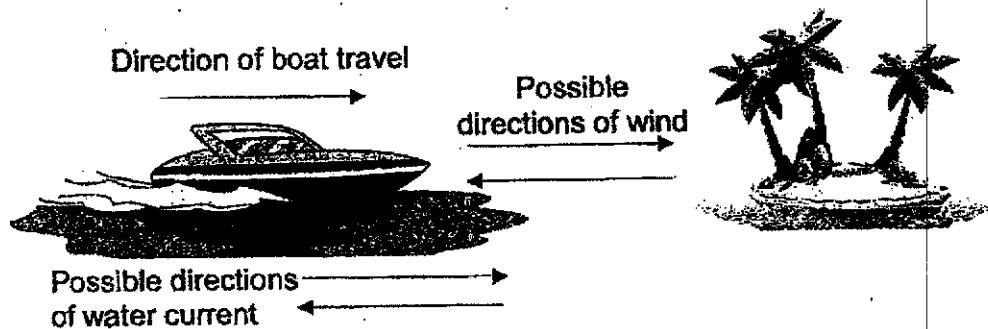

What should the directions of water current and wind be if the boat is to reach the island in the shortest time?

	Direction of water current	Direction of wind
(1)	→	←
(2)	→	→
(3)	←	←
(4)	←	→

13. Linda hung 4 magnets, P, Q, R and S above a tray of identical iron pins as shown below.

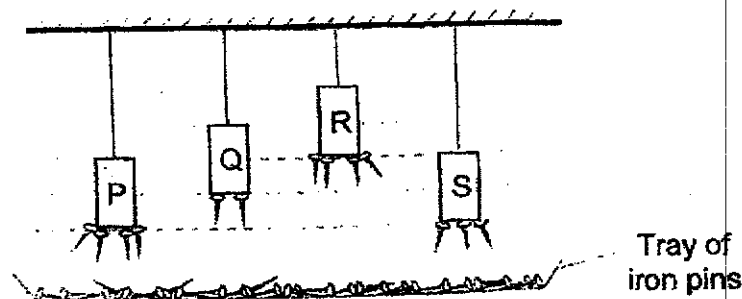

Which of the following conclusions is not possible to tell from the diagram above?

- (1) R is a stronger magnet than P.
- (2) P is a stronger magnet than S.
- (3) Q is a stronger magnet than S.
- (4) R is a stronger magnet than Q.

14. Emily set up and tested a circuit. She recorded the results in the table as shown below.

Switch A	Switch B	Number of lighted bulbs
Open	Open	0
Open	Closed	2
Closed	Open	2
Closed	Closed	2

Based on the table above, which one of the following circuits was set up by Emily?

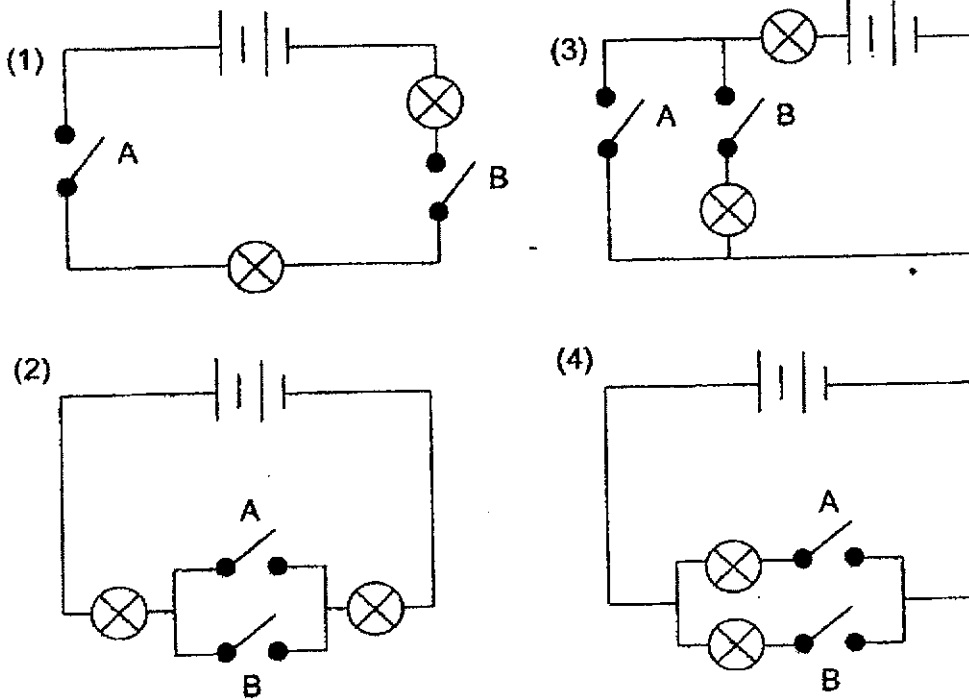

15. The diagram below shows 4 objects, A, B, C and D which are connected to the circuit. Only Bulbs P, Q and R are lighted up. Which objects are definitely electrical conductors?

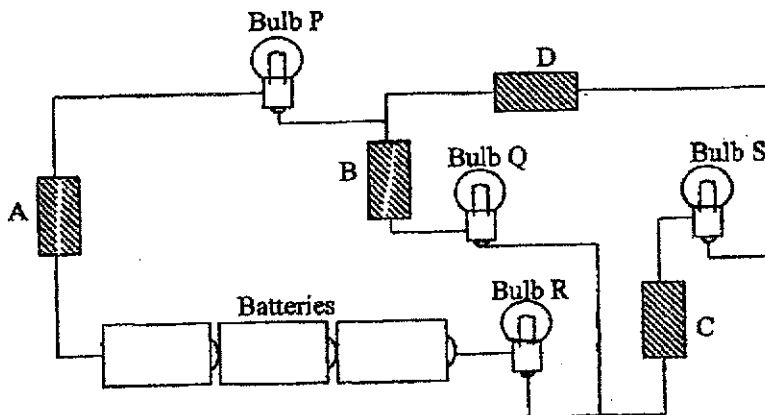

Which objects are definitely electrical conductors?

- (1) A and B only
 (2) A, B and C only
 (3) C and D only
 (4) All of the objects

16. 2 beakers containing different amounts of water were shown to Alex, May, Tom and Dave.

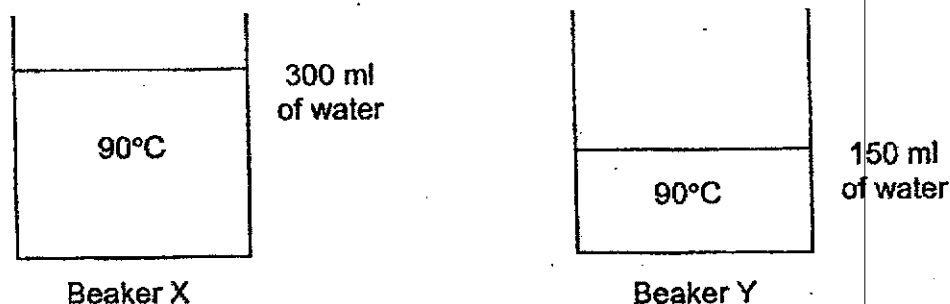

Below are the comments made by each person.

Alex: Water in beakers X and Y have the same amount of heat energy.

May: Water in beaker X has more heat energy than beaker Y's.

Tom: Water in beaker Y has more heat energy than beaker X's.

Dave: Water in beaker Y is warmer than beaker X's.

Who has made the correct comment?

- (1) Alex (3) Tom
(2) May (4) Dave
17. The table below shows the state of 4 substances, A, B, C and D, at different temperatures.

Substance	State of substance at		
	25°C	45°C	70°C
A	Liquid	Liquid	Liquid
B	Solid	Liquid	Liquid
C	Solid	Liquid	Gas
D	Solid	Solid	Solid

Which one of the following statements is definitely correct?

- (1) The boiling point of Substance C is 70°C.
 (2) The freezing point of Substance B is 45°C.
 (3) Substance A has the lowest melting point.
 (4) Substance D has the lowest freezing point.

18. A marble was released from Point W as shown in the diagram below. The marble rolled down the slope, moved along the carpet flooring and stopped at Point Z.

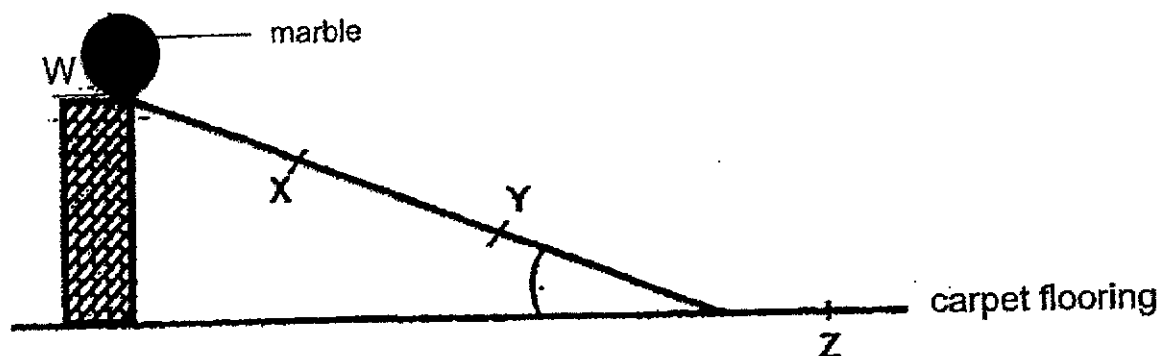

Which one of the following statements is correct?

- (1) The marble has no potential energy at Points X and Y.
 - (2) The marble has more kinetic energy at Point Y than at Point X.
 - (3) The marble would have rolled further if the marble is released at Point X instead of from Point W.
 - (4) The marble has the least potential energy at W.
19. The diagram below shows the children in a room separated by 4 partitions made of different materials.

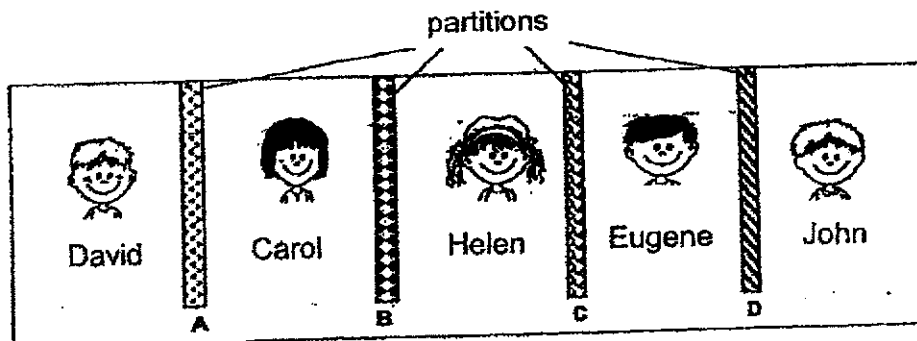

The following observations were made:

- John can only see Eugene.
- Helen can see Carol clearly but Helen is not sure who is beside Carol.

What materials could the partitions be made of?

	A	B	C	D
(1)	Tracing paper	Clear glass	Wood	Clear glass
(2)	Tracing paper	Wood	Tracing paper	Clear glass
(3)	Clear glass	Tracing paper	Wood	Clear glass
(4)	Wood	Tracing paper	Clear glass	Tracing paper

20. Study the diagram of the water cycle as shown below.

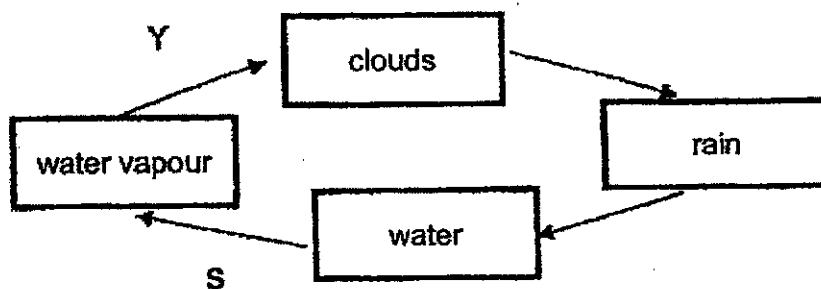

Which one of the following statements about the water cycle are correct?



- A: At process S, the water gains heat from the surroundings.
- B: At process S, the water loses heat to the surroundings.
- C: At process Y, the water vapour gains heat from the surroundings.
- D: At process Y, the water vapour loses heat to the surroundings.

(1) A and C
(2) A and D

(3) B and C
(4) B and D

21. Liz used 3 similar plants, P, Q and R, to investigate how light intensity would affect the amount of sugar produced by plants. A leaf of similar size from each plant was plucked and tested for starch using iodine solution. Iodine will turn dark blue when in contact with starch.

The results of the starch test of each leaf is shown in the table below.

Leaf from Plant	Observations	
P	Iodine solution on most parts of the leaf turned dark blue	 Iodine turned dark blue
Q	Small spots of iodine solution on the leaf turned dark blue	 Iodine turned dark blue
R	Iodine solution on some parts of the leaf turned dark blue	 Iodine turned dark blue

Based on the observations, deduce the most likely light intensity each plant was exposed to.

	Light intensity (units)		
	P	Q	R
(1)	700	1300	2000
(2)	1300	700	2000
(3)	2000	1300	700
(4)	2000	700	1300

22. Kathleen carried out an experiment using the set-up as shown below.

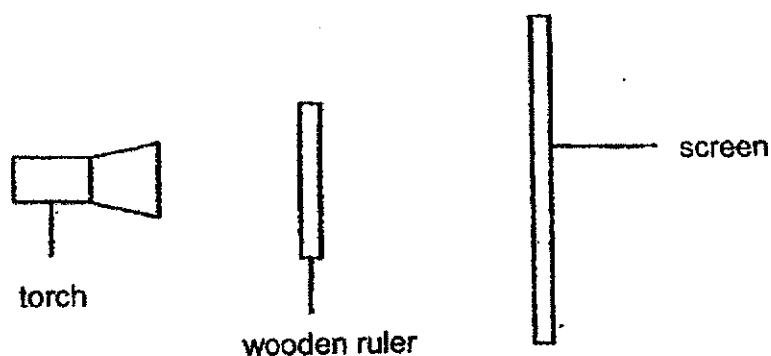

She carried out the experiment by following the steps as listed below.

Step 1	Switch on the torch.
Step 2	Measure the height of the shadow cast by the wooden ruler on the screen.
Step 3	Move the screen 5 cm further away from the torch.
Step 4	Measure the height of the shadow cast by the wooden ruler on the screen.
Step 5	Move the screen 10 cm further away from the torch.
Step 6	Measure the height of the shadow cast by the wooden ruler on the screen.

Kathleen wanted to find out how the size of the shadow cast is affected by

- (1) the brightness of the torch
- (2) the thickness of the wooden ruler
- (3) the distance between the wooden ruler and the screen
- (4) the distance between the torch and the wooden ruler

23. A, B, C and D are blobs of wax on a piece of copper wire shaped in a star shape. When the copper wire was strongly heated at a certain point, the blobs of wax begin to melt in the order of B, C, A and D.

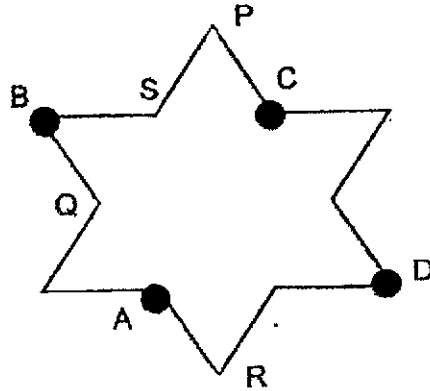

At which point, P, Q, R or S was the wire heated?

- | | |
|-------|-------|
| (1) P | (3) R |
| (2) Q | (4) S |

24. The diagram below shows the cross-sectional view of a flower.

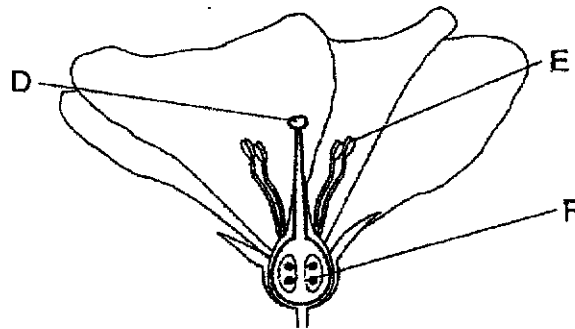

Process Z is needed for both plant and human reproduction.

Which part(s) of the flower does Process Z take place in?

- | | |
|------------|------------------|
| (1) D only | (3) D and F only |
| (2) F only | (4) E and F only |

25. Jeslyn heated a beaker of ice on a burner. The ice melted completely and after some time, the water in the beaker started to boil. After that, she switched off the stove to let the water cool to room temperature.

Which one of the following graphs most likely represents the changes in temperature of the water in the beaker based on what Jeslyn did?

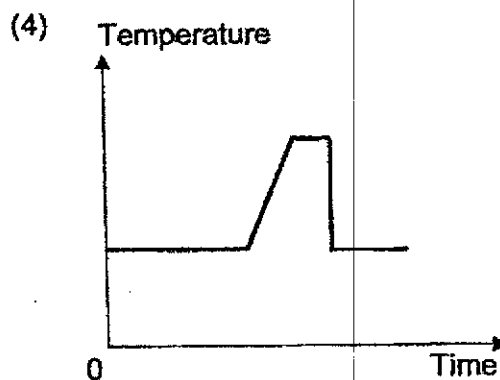
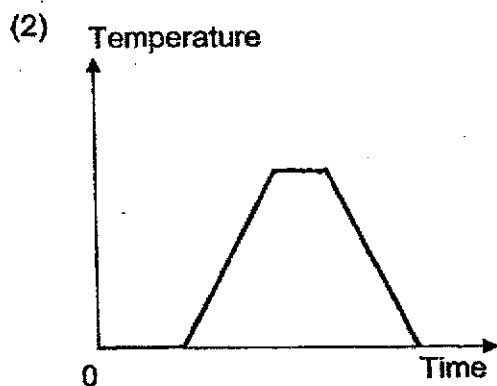
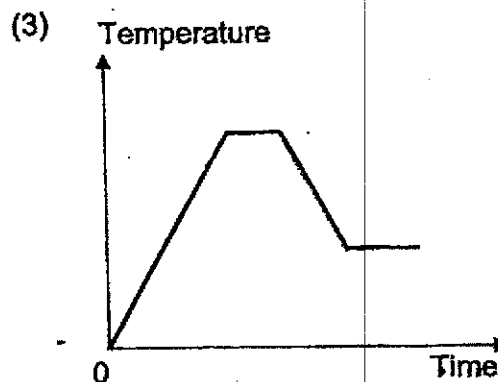
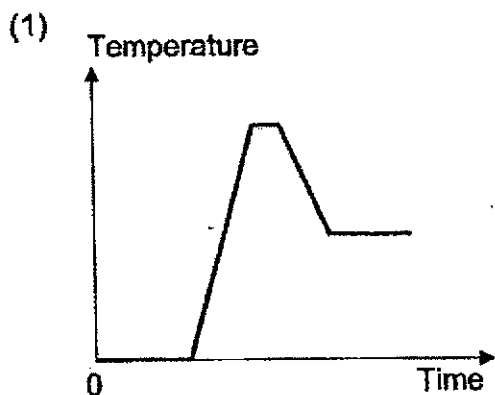

26. The flow chart below shows the reproduction process in flowering plants.

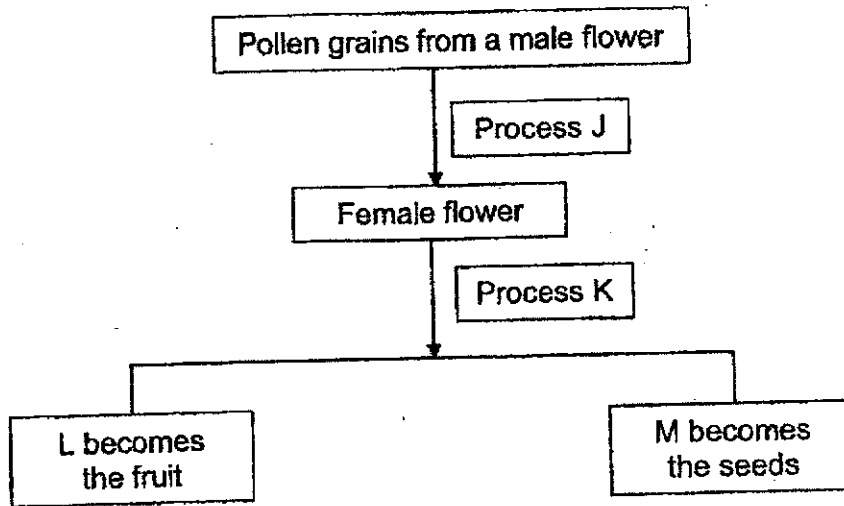

Which one of the following correctly represents J, K, L and M?

	Process		Parts of a flower	
	J	K	L	M
(1)	Seed dispersal	Fertilisation	Ovules	Ovary
(2)	Seed dispersal	Germination	Ovules	Ovary
(3)	Pollination	Fertilisation	Ovary	Ovules
(4)	Pollination	Germination	Ovary	Ovules

27. The graph below shows the number of days for each stage of the life cycles of animals A and B.

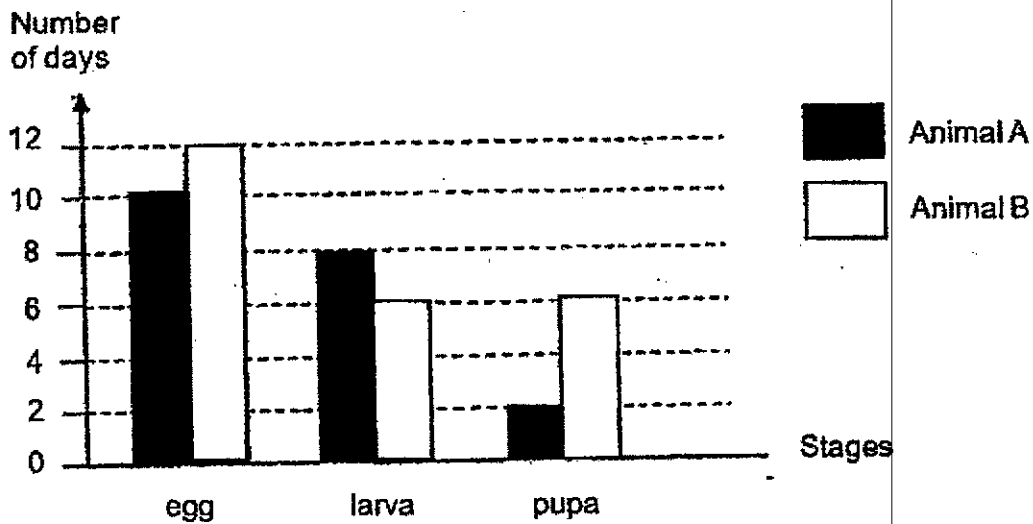

Which one of the following shows the stages that animals A and B would be on the 7th day after the eggs have hatched?

	Animal A	Animal B
(1)	Pupa	Pupa
(2)	Pupa	Larva
(3)	Larva	Larva
(4)	Larva	Pupa

28. Clarisse placed an empty bottle with 2 holes at points S and T into a basin of hot water as shown below.

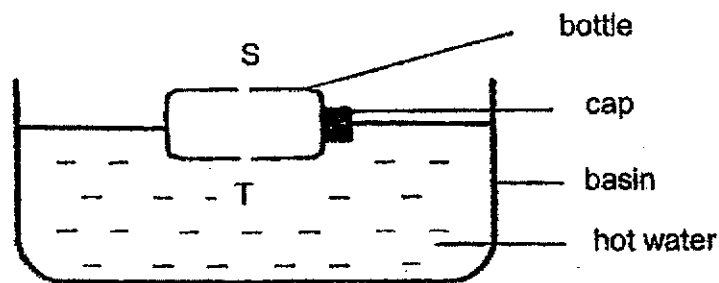

Which of the following would Clarisse observe after some time?

- A: The bottle sinks to the bottom of the basin.
- B: The water level in the basin will remain the same.
- C: Water entered the bottle through T.

- (1) A and C
- (2) B and C
- (3) A and B
- (4) A, B and C

--	--	--	--	--	--	--	--

SINGAPORE CHINESE GIRLS' SCHOOL (PRIMARY)

PRIMARY SIX PRELIMINARY ASSESSMENT 2021

NAME: _____ ()

DATE: 19 August 2021

CLASS: PRIMARY 6 SY / C / G / SE / P

Parent's Signature:

<hr/>

SCIENCE
BOOKLET B

	Total Actual Marks	Total Possible Marks
Booklet A		56
Booklet B		44
Total		100

12 questions

44 marks

Total time for Booklets A & B: 1 h 45 min

DO NOT OPEN THIS BOOKLET UNTIL YOU ARE TOLD TO DO SO.**FOLLOW ALL INSTRUCTIONS CAREFULLY.**

B - 1



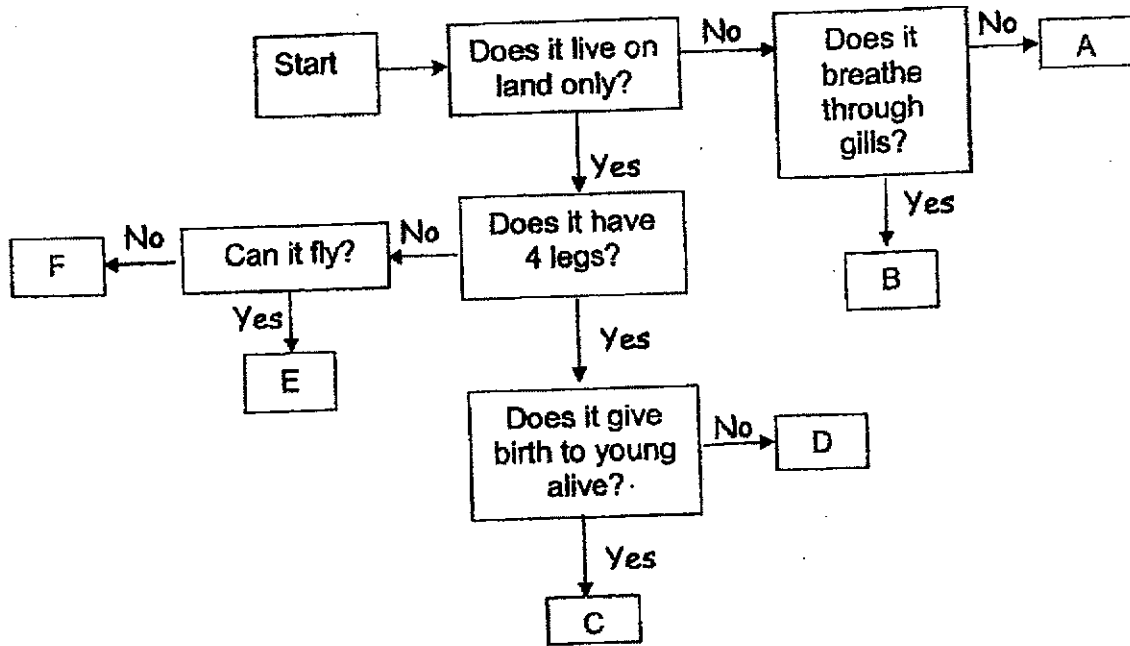

Part II (44 marks)

Answer all the following questions

29. Study the flowchart below. Letters A to F represent different animals.



(a) Fill in the blanks with the letters (A, B, C, D, E or F) that best represent each of the following animals below. [2m]

Animal	 parrot	 dolphin
Letter	(i)	(ii)
	 sheep	 python
Letter	(iii)	(iv)

(b) Based on the flowchart above, state a difference between Animals D and E. [1m]

30. Jiajia placed 2 identical ring magnets, X and Y, through a wooden rod. She observed that the magnets were at a distance S away from each other as shown below.

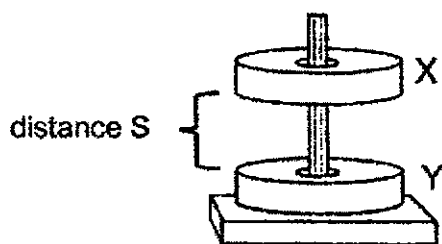

- (a) Explain why Magnets X and Y were at a distance away from each other. [1m]

- (b) A toy below is made up of a C-shaped magnet and a globe floating in the middle.

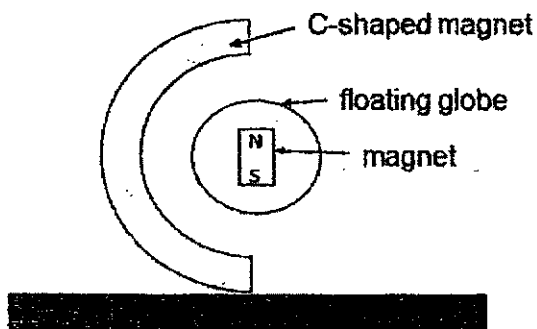

- (i) Name the forces acting on the floating globe. [1m]

- (ii) Describe what happens if a heavier globe is used. [1m]



31. The diagram below shows how blood flows in the human body.

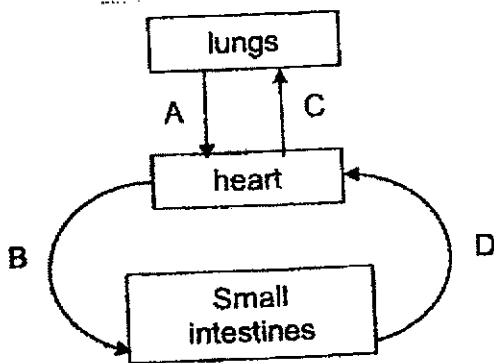

(a) The graph below shows the amount of oxygen in the blood sample taken from A. Indicate the amount of oxygen in the blood taken from B, C and D by filling in the boxes in the graph below. [1m]

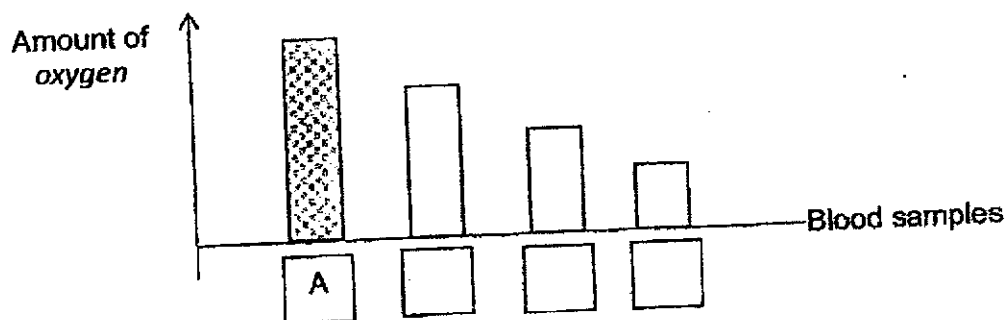

(b) Based on the diagram, compare the amounts of carbon dioxide and digested food in A, B, C and D by ticking (✓) True or False in the table below. [2m]

	True	False
(i) B has more carbon dioxide compared to A.		
(ii) D has more carbon dioxide compared to B.		
(iii) B has more digested food compared to D.		
(iv) D has more digested food compared to C.		

(c) In the diagram below, add 2 arrows to show how blood flows to and from the legs. [1m]

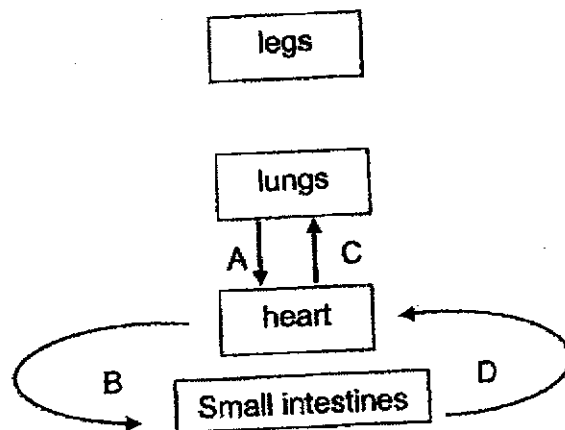

32. Sandy conducted the experiment shown below where she pulled a box horizontally across different floor surfaces, P, Q, R, and S. When the box started to move, the reading on the spring balance was recorded. The table below shows the results for the different surfaces.

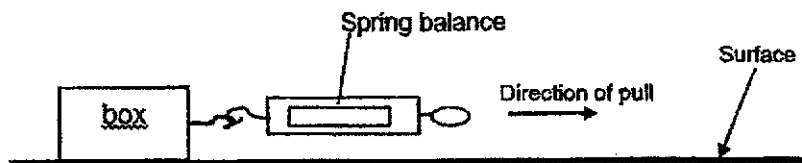

Type of floor surfaces	Reading on spring balance (N)
P	20
Q	15
R	18
S	36

- (a) What is the aim of the experiment? [1m]



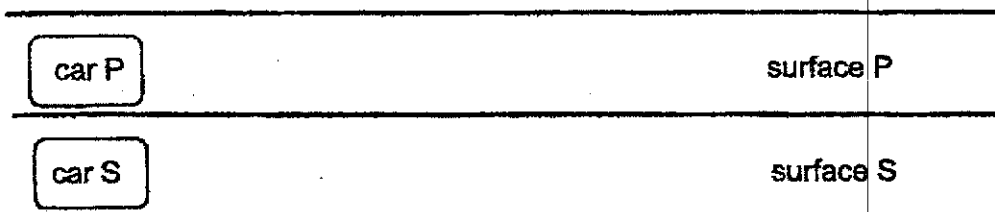

- (b) Sandy and her friend conducted a toy car race. They placed 2 identical cars, P and S, on the surfaces P and S. The cars started off at the same speed. Car P was moving on Surface P while car S was moving on Surface S as shown below.



- Which car, P or S, would come to a stop first? Explain your answer. [2m]



33(a) In the box below, draw a circuit diagram by using symbols given below.

bulb	switch	battery	wire
			

The circuit is made up of :

- 1 battery
- 2 switches
- 2 bulbs, X and Y

The circuit must be able to meet the following conditions:

1. Bulb X can light up if only one switch is closed.
2. Bulb Y will only light up if both switches are closed.

[2m]

You must label the bulbs, X and Y, in your circuit diagram.

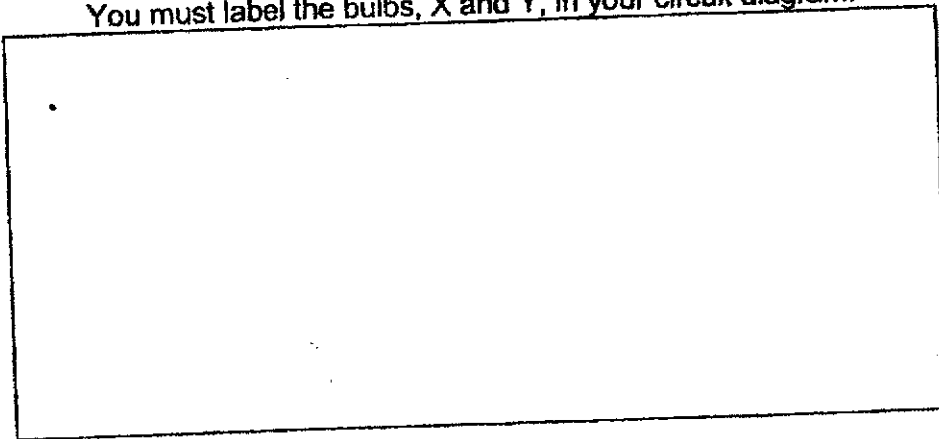

(b) Jane is not sure if liquid W can conduct electricity.

(i) Draw the wires to show how the circuit can be connected to find out if liquid W is a conductor of electricity. [1m]

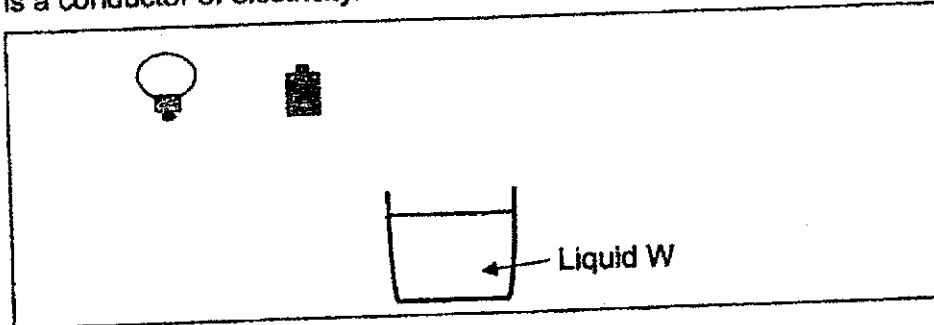

(ii) What must Jane observe in order to conclude that Liquid W is a conductor of electricity? [1m]

34. Dolly was shooting an arrow using a bow below.

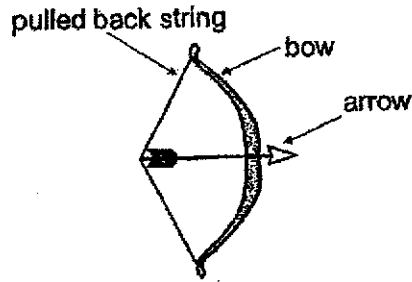

Dolly observed that when the string of the bow was pulled back and released, the arrow travelled in the path as shown below.

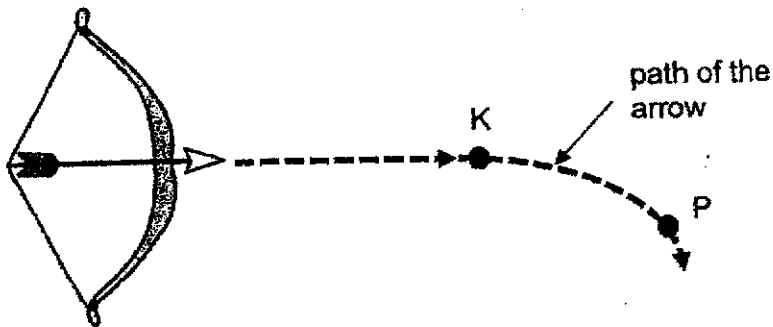

(a) State the source of energy that allowed the arrow to move towards position K. [1m]

(b) What force caused the arrow to move downwards after K? [1m]

(c) Dolly thought that using a heavier arrow would cause the arrow to travel further. Do you agree with her? Explain your reason. [1m]

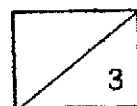

35. Ben placed 3 similar loaves of bread in 3 identical sealed boxes filled with air. He placed boxes A and B in a warm place and box C in a cold place. Substance X absorbs water from the surroundings.

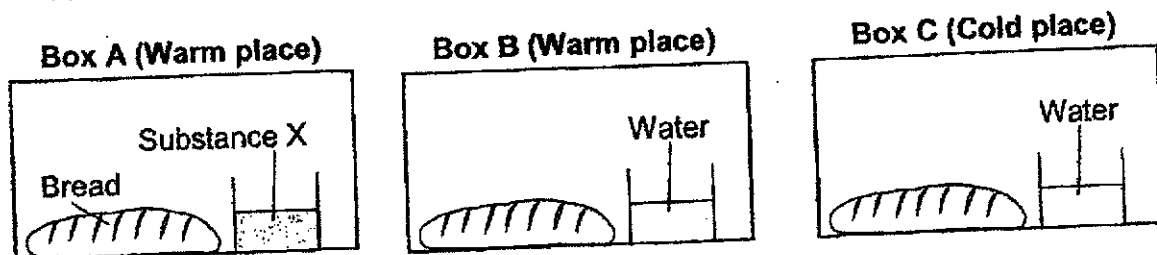

(a) Explain why using boxes of the same size makes Ben's experiment fair. [1m]

(b) After 3 days, which box will have bread with the most mould? Explain. [1m]

(c) Ben had a leather jacket in his cupboard. He took it out and found that it had turned mouldy.

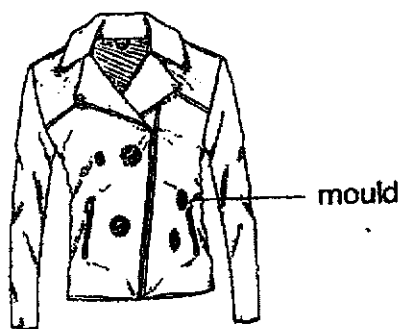

Suggest 2 things Ben could do to prevent his jacket from turning mouldy. [2m]

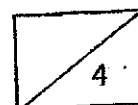

36. The diagram below shows the female reproductive system.

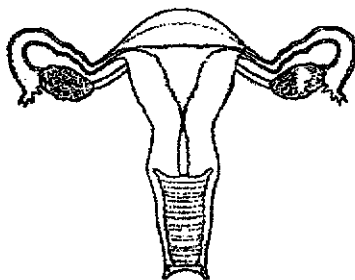

- (a) In the diagram above,
- (i) label the part where female sex cells are found as 'P', [1m]
- (ii) circle the part where a fertilised egg will develop. [1m]
- (b) Due to a medical condition, one of Judy's ovaries was removed. Can fertilisation still take place? Explain your answer. [1m]
-

37. Catherine had a plastic container which held 50 cm^3 of air. She used a syringe to remove 15 cm^3 of air from the plastic container as shown in the diagram below.

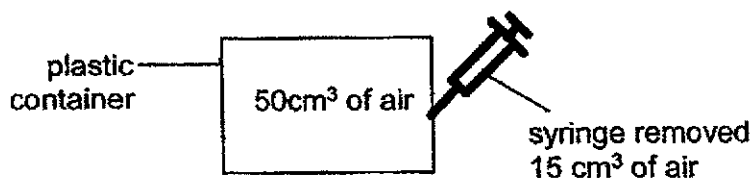

- (a) What was the volume of air in the container after the air was removed? [1m]
 Volume of air remaining in the container. _____ cm^3
- (b) State the property of air that you used for answer (a). [1m]
-
- (c) Did the mass of the container increase, decrease or remain the same after air was removed? Give a reason for your answer. [1m]
-

38. Shawn filled a pail with sand and hung it above a metal plate. A hole was made at the base of the pail for the sand to drip out. As the sand hit the metal plate, a sound could be heard.

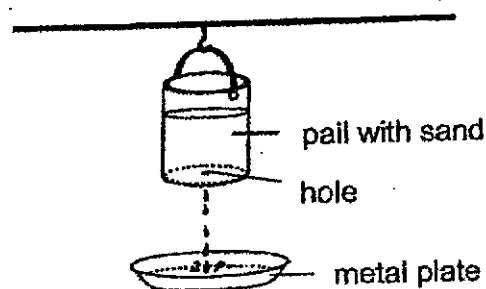

- (a) State the energy changes which took place when the sand from the pail dripped onto the metal plate. [1m]

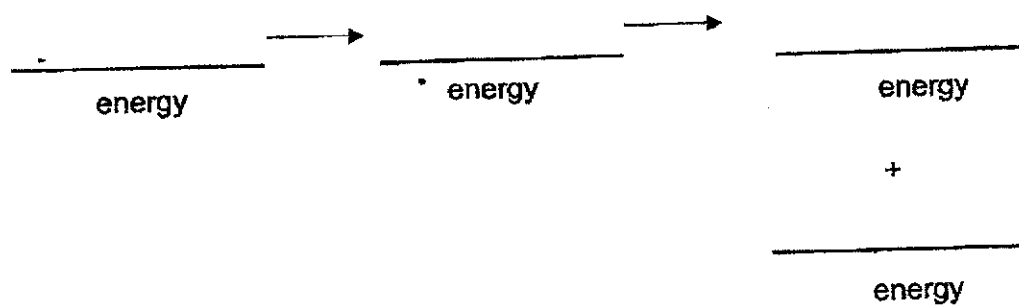

- (b) Explain how enlarging the hole caused the sound to become louder. [2m]

- (c) Without adding any other apparatus to the set-up above, suggest another thing Shawn can do to make the sound louder. [1m]

39. Lily wanted to investigate how the clarity of water affects the rate of photosynthesis in plants. She placed similar water plants and fish into 3 identical tanks A, B and C, as shown below. Each tank was filled with 3 litres of water from different ponds, A, B and C.

A light source was placed near the tanks as shown below. The other lights were switched off in the dark room.

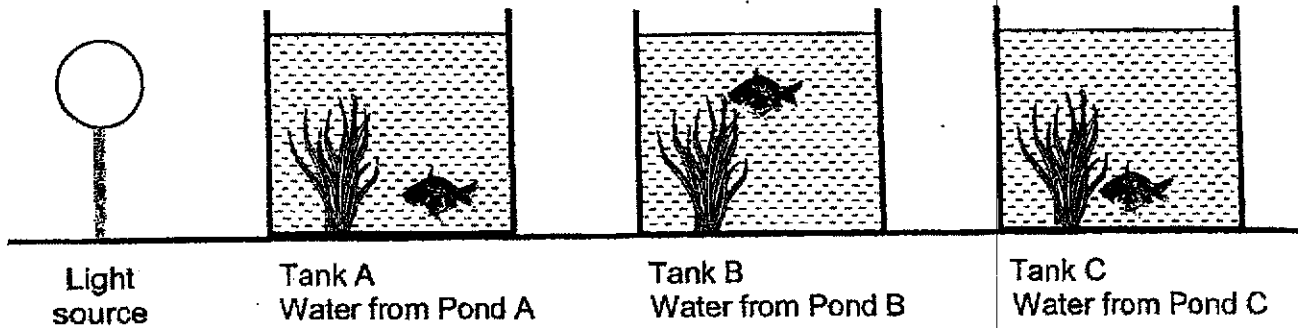

(a) Suggest how adding the fish might improve the experiment.

[1m]

(b) Lily did not set up a fair test. Explain why.

[1m]

Please continue Q39 on page B-12.

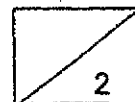

39(c) Using exactly the same apparatus, draw and label how you can arrange the apparatus to make it a fair test in the space below. [1m]
 The original arrangement has been drawn as a reference.

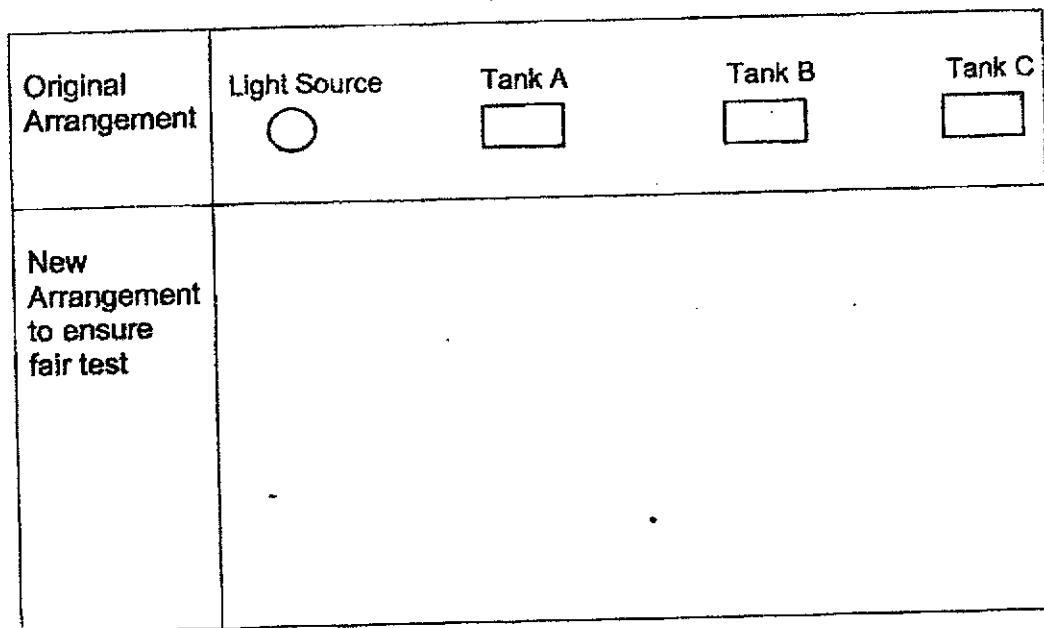

(d) After making the changes so that her experiment was fair, Lily recorded the results of her experiment in the table below.

Amount of Oxygen/ units	Tank A	Tank B	Tank C
At the start	6	6	6
After 2 hours	12	18	14
After 5 hours	23	33	25

Which pond has the clearest water that allows the most light to pass through? Explain your answer. [2m]



40. Jazzy set up the experiment as shown below.

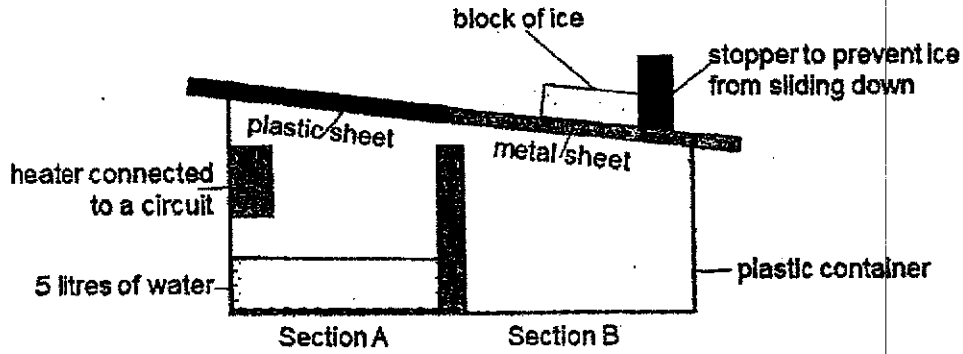

When she switched on the heater, 0.5 litres of water was collected in Section B of the plastic container after 3 hours.

(a) State the process which took place in Section A and Section B. [1m]

Section A: _____

Section B: _____

(b) Explain the purpose of the heater. [1m]

(c) Explain why a metal sheet was used in section B instead of using plastic? [1m]

(d) Explain why more water is collected if the heater is placed in the water. [2m]

End of Booklet B

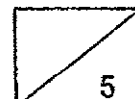

Name: _____ ()

Class: **Pri 6 SYIC/ISE/P**

2021 SCGS PRI 6 SCIENCE PRELIMINARY EXAMS

Part 1 (50m)

1.	4	5.	2	11.	2	16.	2	21.	4	26.	3
2.	1	6.	3	12.	2	17.	3	22.	3	27.	4
3.	1	7.	4	13.	3	18.	2	23.	4	28.	1
4.	3	8.	3	14.	2	19.	1	24.	2		
5.	2	9.	4	15.	1	20.	2	25.	1		

Part 2 (44m)

Suggested Answers

29a	(i) parrot - E (ii) Dolphin - A (iii) Sheep- C (iv) python - F															
29b	Animal D has 4 legs but E does not.															
30a	Like poles of magnet facing each other, so they repel.															
30b	(i) Gravitational force/ gravity and magnetic force (ii) The globe will drop / move lower															
31a	A (given) B D C															
31b	<table border="1"> <thead> <tr> <th>Statements</th> <th>True</th> <th>False</th> </tr> </thead> <tbody> <tr> <td>(i) B has more carbon dioxide compared to A.</td> <td>✓</td> <td></td> </tr> <tr> <td>(ii) D has more carbon dioxide compared to B.</td> <td>✓</td> <td></td> </tr> <tr> <td>(iii) B has more digested food compared to D.</td> <td></td> <td>✓</td> </tr> <tr> <td>(iv) D has more digested food compared to C.</td> <td>✓</td> <td></td> </tr> </tbody> </table>	Statements	True	False	(i) B has more carbon dioxide compared to A.	✓		(ii) D has more carbon dioxide compared to B.	✓		(iii) B has more digested food compared to D.		✓	(iv) D has more digested food compared to C.	✓	
Statements	True	False														
(i) B has more carbon dioxide compared to A.	✓															
(ii) D has more carbon dioxide compared to B.	✓															
(iii) B has more digested food compared to D.		✓														
(iv) D has more digested food compared to C.	✓															

Diagram C:

Diagram D:

32a	To find out if different surfaces affects the amount of frictional force.
32b	Car S will stop first as Surface S is rougher than Surface P, so it has more <u>frictional force</u> / <u>more friction</u> between the car and the surface.
33a	<ul style="list-style-type: none"> - One switch must be in series with BULB Y - One switch must be in series with the battery - Bulbs are in parallel (no switch in series with X) <p>Example:</p>
33b	(i) (ii) The bulb lights up
34a	Stretched string / pulled-back string/ pulled string
34b	The <u>gravitational force</u> / <u>gravity</u> pulled it <u>down</u> / <u>downwards</u> to P.
34c	No. A heavier arrow means <u>more gravitational force</u> pulling it <u>down</u> , so it will travel a shorter distance. OR No. A heavier arrow needs to pull back the arrow <u>more</u> so that <u>more</u> potential energy can be <u>converted to more</u> kinetic energy to <u>move it as far</u> .
35a	It makes it fair as the amount of air in the boxes will affect the results of the experiment, thus the amount/ volume of air in the boxes <u>must be the same/similar/ constant</u> .
35b	B. B is warmer than C, and B has more moisture than C (0.5m). OR B has (air), warmth and moisture but A doesn't have moisture and C doesn't have warmth.
35c	Any 2 suggestions: He could pack his jacket in a plastic bag and put Substance X.

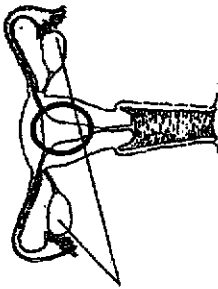
<p>He could pack his jacket in a plastic bag and remove the air (vacuum-pack) the bag. He could place the jacket in a cold/cool place/ refrigerator/ cold store</p>	<div style="text-align: center;">  </div> <p>Part P (Either one)</p>
<p>36a</p>	<p>Yes. The other ovary can still <u>produce/release eggs</u>.</p>
<p>(i) (ii)</p>	<p>50</p>
<p>36b</p>	<p>Air has <u>no definite/ fixed volume</u>. Not accepted 'Air can be compressed' (not applicable to scenario given)</p>
<p>37a</p>	<p>Decrease. Air has mass and when some air has been removed, there will be less air and thus less mass in the container.</p>
<p>37b</p>	<p>(gravitational) <u>potential energy</u> → <u>kinetic energy</u> → <u>heat energy + sound energy</u></p>
<p>37c</p>	<p>When the hole is bigger, more sand will drip/fall. <u>More sand will have more mass and have more kinetic energy</u> which is <u>converted to more sound energy</u> to make a louder sound.</p>
<p>38a</p>	<p>Raise the pail higher</p>
<p>38b</p>	<p>OR Increase distance between the hole/ pail/ sand container and the plate/ floor.</p>
<p>38c</p>	<p><How adding fish <u>improved the experiment?</u>> - must show comparison</p>
<p>39a</p>	<p>Fish can provide more / increase carbon dioxide for more/ faster photosynthesis.</p>

<p>39b</p>	<p>The plants are at different distances away from the light source OR The plants in different tanks did <u>not receive the same</u> amount of light <u>receive the same</u></p>
<p>39c</p>	<p>Any arrangement showing <u>equal distances</u> between light and each of the 3 tanks clearly. <Distances between light and each tank must be the same></p>
<p>39d</p>	<p>B. The plant in B received the <u>most light</u> to carry out the <u>most/ fastest photosynthesis</u> to produce the <u>most oxygen</u>.</p>
<p>40a</p>	<p>Section A: Evaporation Section B: Condensation</p>
<p>40b</p>	<p>Water can gain more heat <u>evaporate faster/ more</u>. OR Water vapour can <u>become hotter</u> that it can <u>condense more/ faster</u> (on the metal sheet later). Note: Difference between 'water' and 'water vapour'</p>
<p>40c</p>	<p>Metal is a <u>better</u> conductor of heat than plastic AND Thus <u>water vapour</u> can <u>lose heat/ more faster</u> (to sheet/ice) to <u>condense faster</u>.</p>
<p>40d</p>	<p>Ideas needed in answer: - Comparison on heat gain by water (when heater was on water and outside water) - resulting in faster / more evaporation - producing more water vapour - allowing for more condensation into water droplets Example If heater is in the water, the <u>water can gain more heat/ heat faster</u> than when heater is outside water so the water <u>can evaporate faster</u> to <u>produce more water vapour</u>. Hence more water will be collected in Section B as there is <u>more water vapour condensed</u> into water droplets</p>