



AI TONG SCHOOL

2004 SEMESTRAL ASSESSMENT (1)

PRIMARY SIX

Duration : 1hour 45min

Date: 18th May 2004

INSTRUCTIONS

Do not open the booklet until you are told to do so.

Follow all instructions.

Answer all questions.

Name : _____ ()

Marks :



Class : Primary _____

Parent's Signature : _____

Date : _____

1. (A)

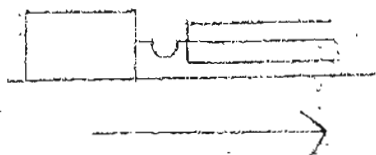

(B)

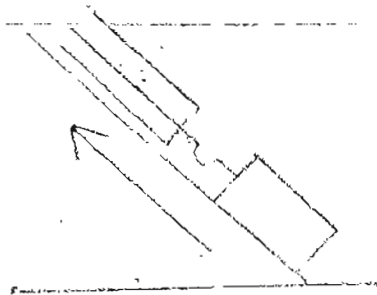

(C)

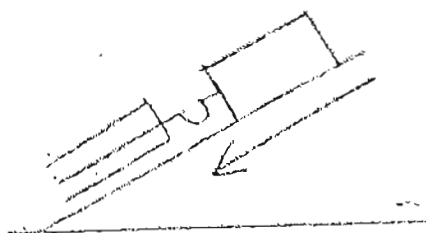

(D)

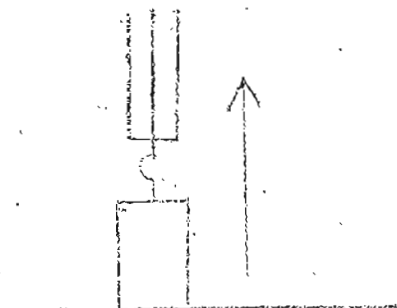

A spring balance was used to pull a block of wood as shown in the diagrams above. In which of the diagrams was the greatest force used?

- (1) A
- (2) B
- (3) C
- (4) D

2.

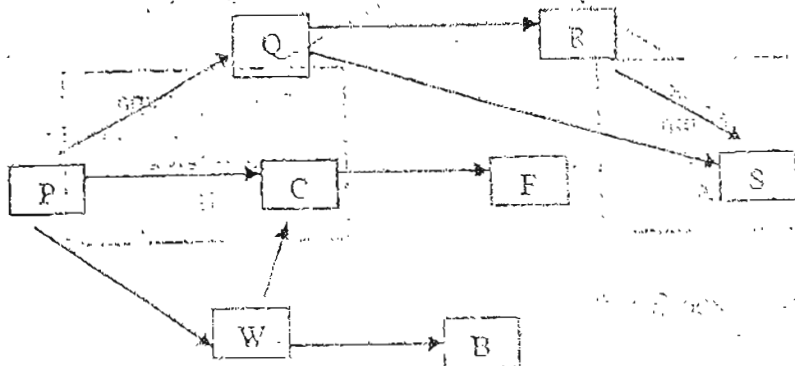

Study the food web. Which of the following statement is false?

- (1) R is a carnivore.
- (2) S is a predator of Q.
- (3) P is a food producer.
- (4) C is a herbivore.

3. Which of the following simple machine(s) use(s) less than 10kg of effort to lift the load?

(A)

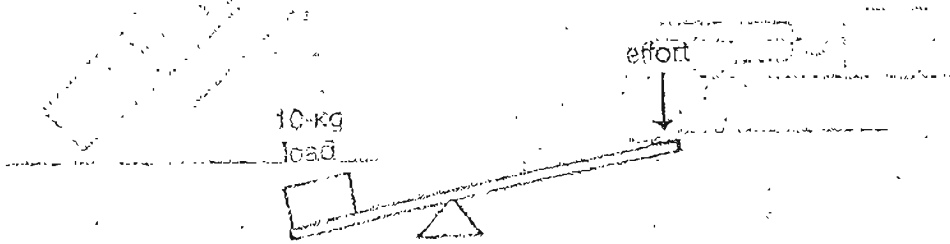

(B)

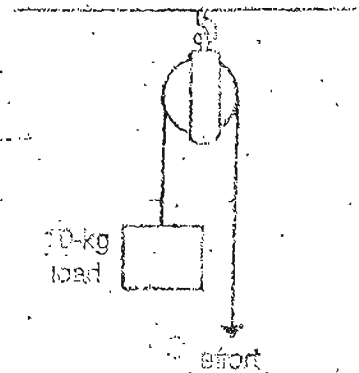

(C)

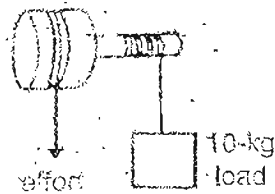

(1) B only

(3) B and C only

(2) A and C only

(4) All of the above

4. Study the classification below.

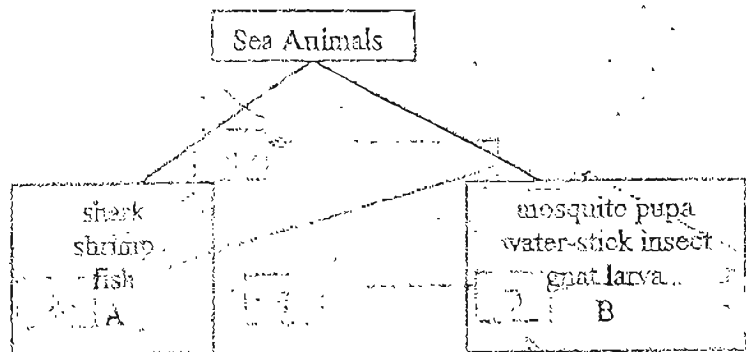

What can A and B be?

	A	B
(1)	tapeworm	tadpole
(2)	dragonfly nymph	water scorpion
(3)	tadpole	water spider
(4)	backswimmer	mayfly nymph

5. Holly used a catapult to shoot some seeds against a tree. The catapult is shown below. What should she do if she wants to increase the force of her shots?

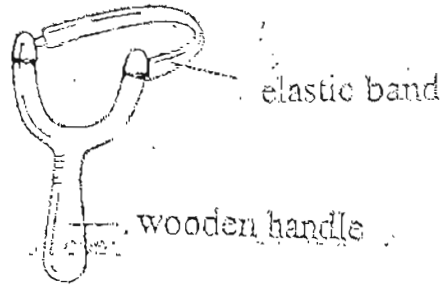

- (1) She should use less effort to pull the elastic band.
- (2) She should use more effort to pull the elastic band.
- (3) She should extend the length of the wooden handle.
- (4) She should shorten the length of the wooden handle.

6. Dolphin, Platypus, Goat, Zebra

The above animals can be grouped together because they _____

- (1) live on land
- (2) give birth to their young
- (3) are herbivores
- (4) have an outer covering of hair

7. Marcus throws a ball upwards. It reaches a maximum height then falls to the ground.

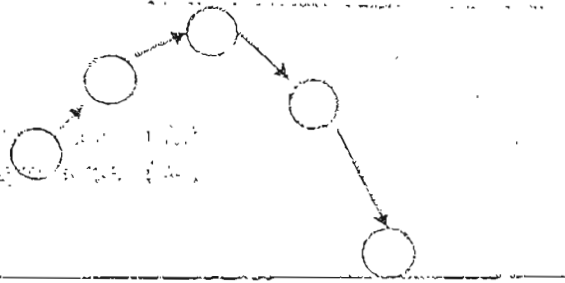

Which of the following statements about the moving ball is true?

- (1) Gravity acts on the ball throughout.
- (2) When the ball reaches its maximum height, there is no force acting on it.
- (3) When the ball reaches its maximum height, gravity begins to act on it.
- (4) The speed of the ball is constant throughout.

8. Which group of animals belong to a pond community?

- (1) guppy, water snail, dragonfly nymph
- (2) snail, slug, mealy bug
- (3) butterfly, bee, ant
- (4) ant, earthworm, millipede

9. Which of the following statements about decomposers and decomposition are true?

- (A) They break down dead animals into simple substances.
- (B) During the process of decomposition, carbon dioxide is given out.
- (C) Snails, earthworms and termites are decomposers.
- (D) Decomposers prevent dead animals from piling up.

- (1) A, B and C only
- (2) B, C and D only
- (3) A, B and D only
- (4) All of the above

10. Which of the following is classified wrongly?

Group X	Group Y
wooden door	overhead transparency
book	glass
brick	canvas bag

- (1) glass
- (2) brick
- (3) book
- (4) canvas bag

11.

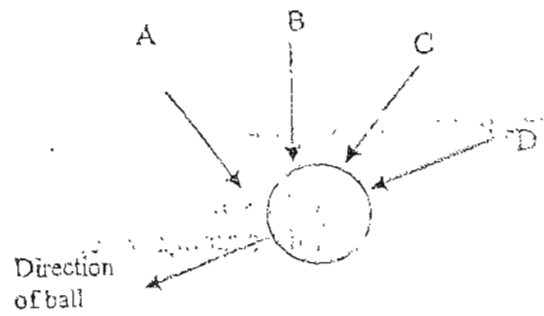

A force is applied from 4 directions. Which one (A, B, C or D) will cause the ball to move in the direction as shown above?

- (1) A (2) B (3) C (4) D

12.

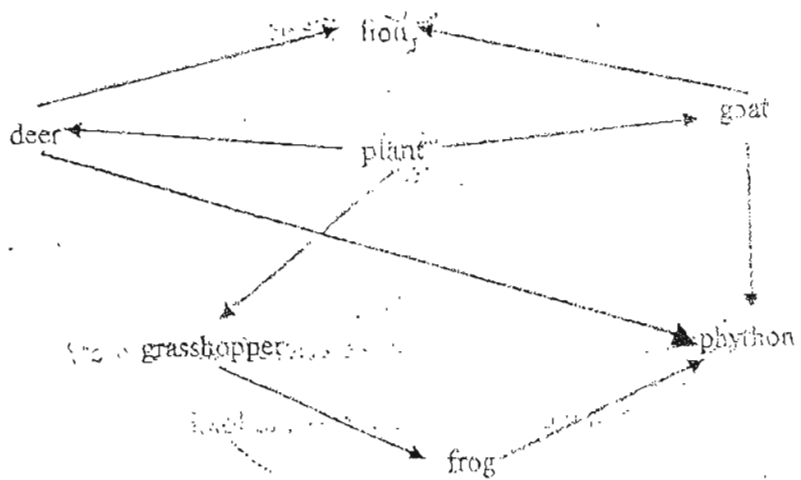

How many food chains are there in the food web shown above?

- (1) 2 (2) 3 (3) 5 (4) 7

15. A clock needs 2 batteries in order to work. Which one of the following shows correctly the change of energy in the clock?

(1) Kinetic energy \longrightarrow Chemical energy \longrightarrow Electrical energy

(2) Chemical energy \longrightarrow Kinetic energy \longrightarrow Electrical energy

(3) Chemical energy \longrightarrow Electrical energy \longrightarrow Kinetic energy

(4) Electrical energy \longrightarrow Chemical energy \longrightarrow Kinetic energy

16. Letters A to H in the food web below represent living things.

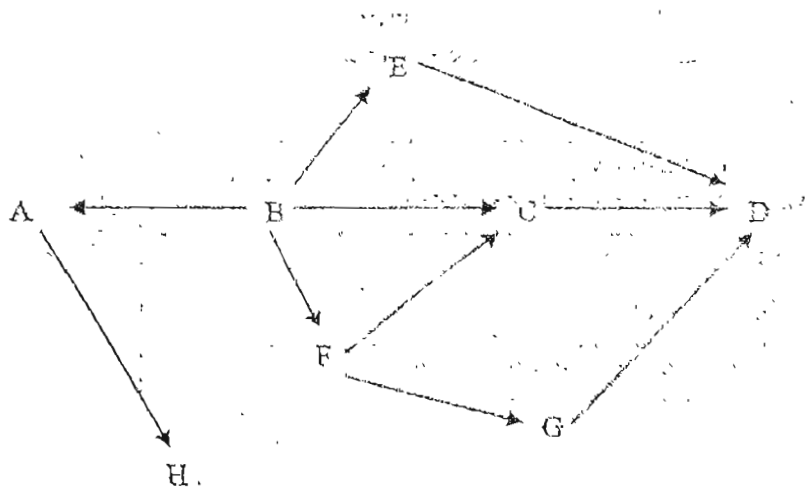

Which of the following prediction is correct?

(1) When population F decreases, populations C and G will increase.

(2) When population B decreases, populations C, E and F will increase.

(3) When population C increases, population D will decrease.

(4) When population D increases, populations C, E and G will decrease.

17. Which of the following characteristics help (s) water hyacinth to float on water?

(A) air spaces

(B) fleshy leaves

(C) waxy leaves

(1) A only

(2) A and B only

(3) A and C only

(4) B and C only

18. Which one of the following organisms help to speed up the process of decomposition by breaking the dead organism into smaller pieces?

(1) Fungi

(2) Mould

(3) Bacteria

(4) Termites

19. The following aquatic animals are grouped according to their breathing adaptations. Which group of animals does not breathe in the same way?

	Aquatic animals
(1)	water stick insect, water scorpion
(2)	tubifex worm, tadpole
(3)	crab, wood louse
(4)	water spider, great diving beetle

20. Trees in the rainforest have leaves growing only at the top of the trees. This is because _____.

(1) they compete with one another for rain water

(2) they compete with one another for sunlight

(3) the leaves do not grow well at the bottom

(4) the tree has lesser leaves to reduce the loss of water through transpiration

21. Study the food chain below.

maize plant → grasshopper → wren → hawk

Which of the following graphs represents the above food chain?

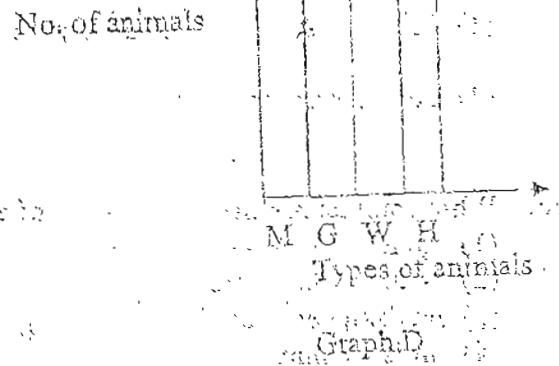
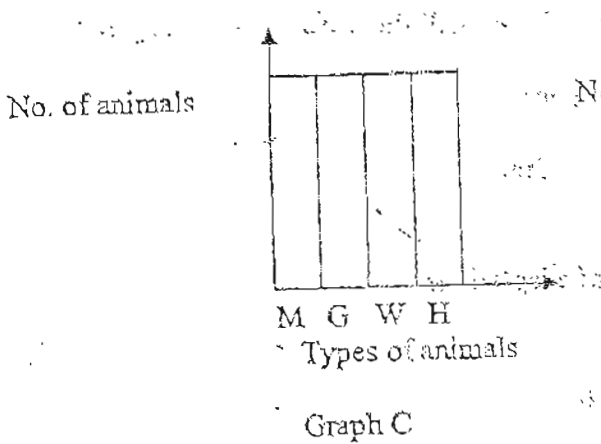
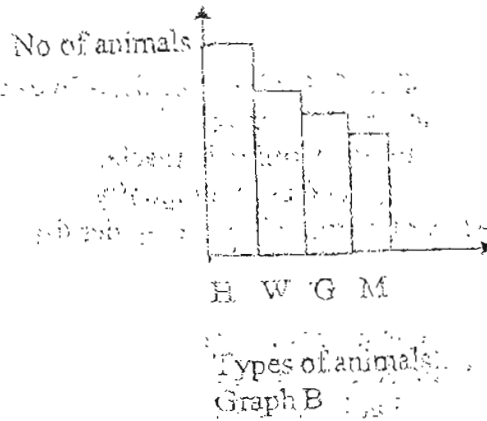
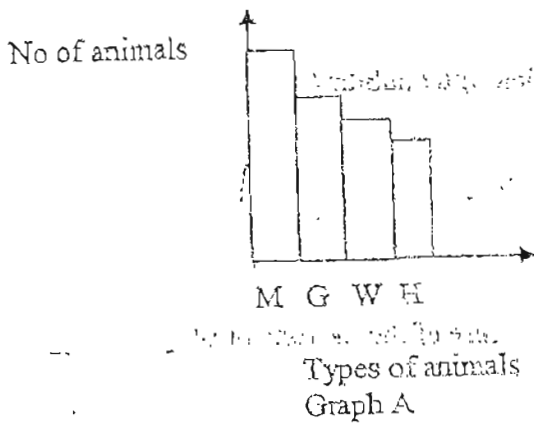

Key:	
M	Maize plant
G	Grasshopper
W	Wren
H	Hawk

(1) A

(2) B

(3) C

(4) D

22. Which of the following aquatic plants will not grow well in a very muddy pond?

- (1) water moss fern
- (2) water lily
- (3) water lettuce
- (4) tape grass

23. Which of the following organisms live in a leaf litter habitat?

- (1) ant, scorpion, slug
- (2) butterfly, termite, barnacles
- (3) snail, woodlouse, dragonfly
- (4) earthworm, millipede, spider lily

24. We experience day and night on the Earth because of the movement of _____

- (1) the Sun around the Earth
- (2) the Earth on its own axis
- (3) the Earth round the Sun
- (4) the Moon on the Earth's axis

25. If May sees a full moon on 15th August. When will she see a full moon again?

- (1) 31st August
- (2) 5th September
- (3) 20th September
- (4) 12th September

26. Which animal has the correct form of adaptation?

- (1) camel - bristles on its feet
- (2) whale - blow holes in its head
- (3) mudskipper - lungs for breathing
- (4) birds - compact bones

27. What are the conditions needed for a seed to germinate?

- (A) water
- (B) oxygen
- (C) warm
- (D) sunlight

- (1) A only
- (2) A and B only
- (3) A, B and C only
- (4) All of the above

28. Which of the following factors will directly affect the population of lions in a community?

- (A) Presence of herbivores
- (B) Lack of water
- (C) The amount of sunlight
- (D) The size of a habitat

- (1) A only
- (2) A and B only
- (3) A, B and C only
- (4) A, B and D only

29. A circuit card is tested with a circuit tester. The results are recorded as follows:

Clips tested	Bulb of circuit tester
A and C	Lights up
A and D	Does not light up
B and C	Lights up
B and D	Does not light up
C and D	Does not light up

Which is the circuit card tested?

(1)

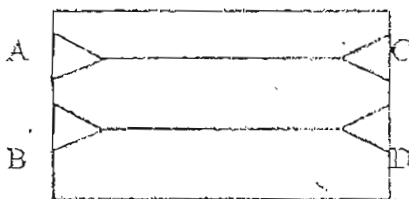

(2)

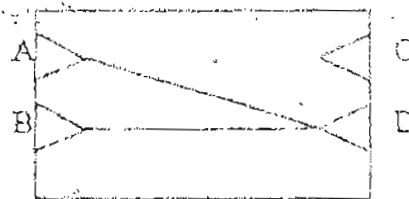

(3)

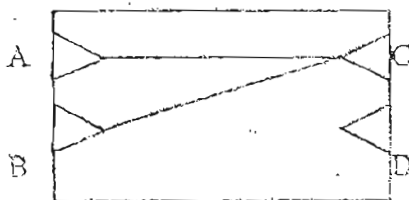

(4)

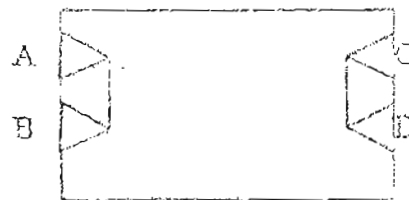

30. The table below shows the properties of cells X, Y and Z.

	X	Y	Z
Cytoplasm	✓	✓	✓
Cell membrane	✓	✓	✓
Nucleus	✓	✓	✓
Cell wall	✓	✓	
Sap	✓	✓	
chloroplasts	✓		

The following students make the following conclusions:

- (A) Alice: Only cell X is plant cell
- (B) Betty: Cell X and Y are plant cells. Cell Z is an animal cell.
- (C) Candice: We cannot determine if Z is plant or animal cell from the information given.
- (D) Deborah: All the cells are plant cells.

Which one of the statement(s) is/are correct?

- (1) A only
- (2) B only
- (3) A and B only
- (4) C and D only

Name : _____

Class : _____

Section B

Fill in the blanks with the correct answers.

31. Construct a simple food chain with 4 of the organisms given in the box. [2]

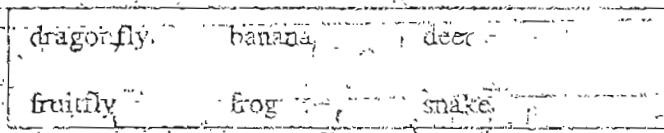

32. David set up the apparatus as shown.

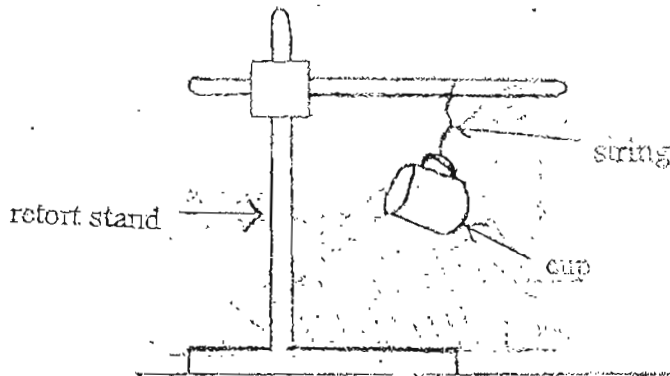

(a) What prevents the cup from falling? [1]

(b) What happens when the string is cut? [1]

(c) Name the force that makes the cup fall. [1]

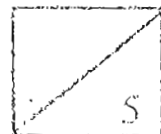

33. Classify the following plants into 3 groups. [3 marks]

lotus	water hyacinth	duckweed
water banana	hydrilla	cattail

Fully Submerged	Partially Submerged	Floating

34. A ramp is set up as shown. The surface is lined with sand paper first. A wooden block is tied to a string and made to move up the surface by adding marbles one at a time to the pan. The experiment is repeated on a surface which is lined with wax paper.

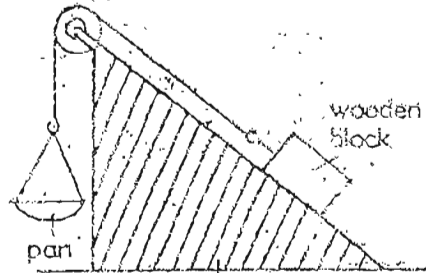

(a) On which surface would the block require more marbles to move up the same distance on the ramp? [1]

(b) Give a reason for your answer in (a). [2]

35. Name 2 factors that will affect the population in a community. [2]

(a) _____

(b) _____

36. John recorded the length of a spring when various weights are hung on the spring balance. From the information gathered, he plotted the graph below. Study the graph and answer the following questions.

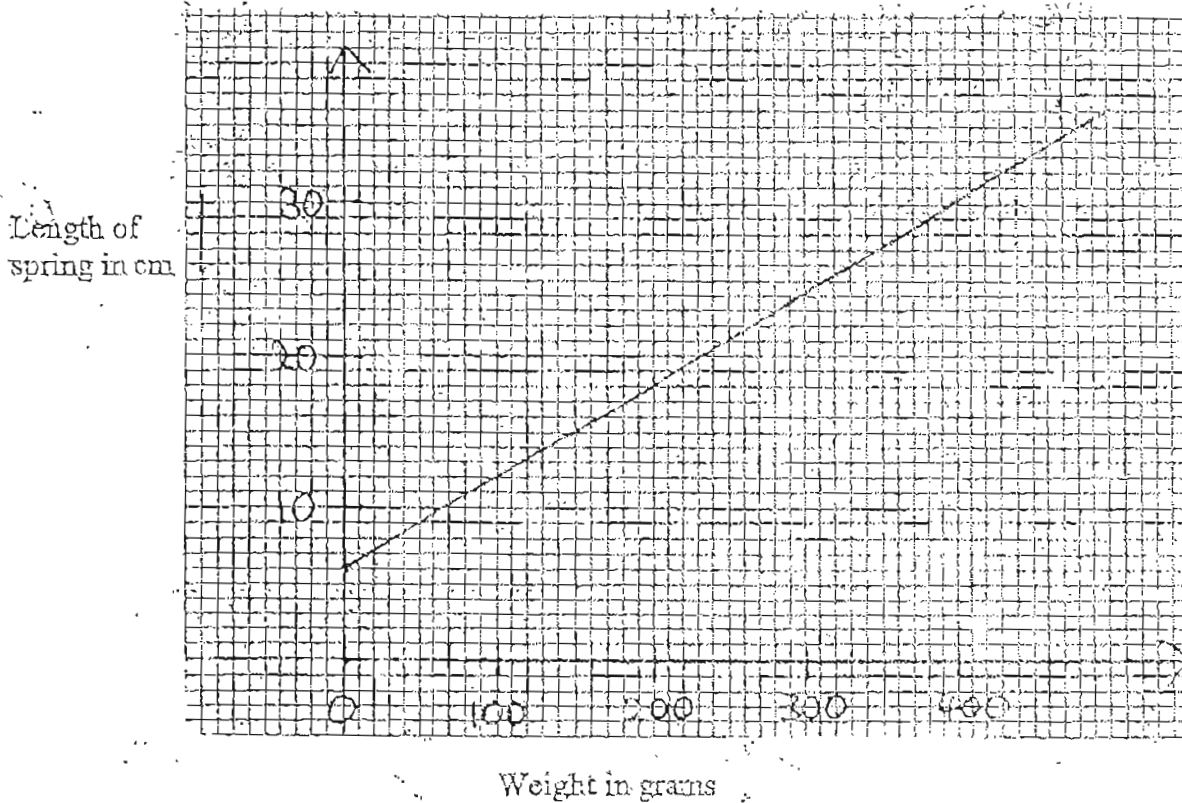

(a) What is the original length of the spring? [1]

(b) What was the extension of the spring when a weight of 150g was attached? [1]

(c) What do you think will be the extension of the spring when a weight of 400g is attached? [1]



37 (a) How is the mudskipper adapted to breathe when it is out of water? [2]

(b) Name another aquatic organism that has the same adaptation. [1]

38. Four objects, A, B, C, D are weighed on four equal-armed balances as shown below. Arrange them in ascending order of their weights: [2]

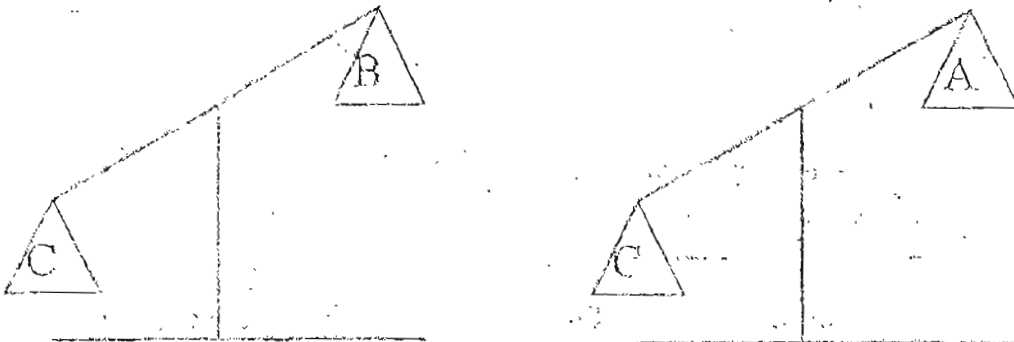
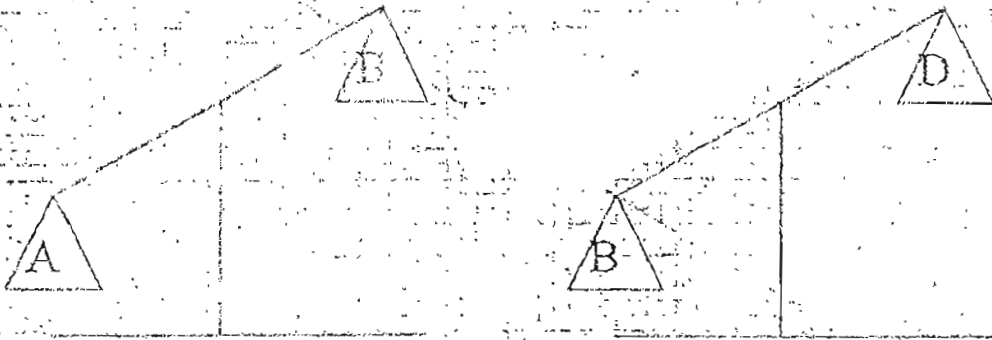

Write your answer in the boxes provided below:

1 st	2 nd	3 rd	4 th

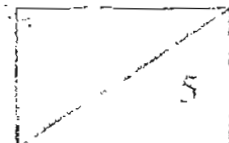

39. The table below shows the various stages of the life cycle of a flowering plant.

A	Growth of roots and leaves
B	Development of flowers
C	Germination of seed
D	Dispersal of fruit and seed
E	Development of seed

Arrange them in the correct order by writing down the letters A to D in the boxes. [2]
The last stage has been done for you.

1 st	
2 nd	
3 rd	
4 th	
5 th	E

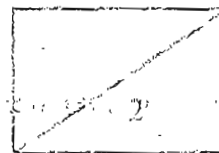

40. A plastic cylinder was rolled over on four different platforms of equal lengths using the same amount of force. The distances travelled by the cylinder before coming to rest are shown in the table below.

Platform	Distance travelled (cm)
A	200
B	133
C	300
D	265

- (i) Which platform has the roughest surface? [1]

- (ii) Explain your answer in (i)? [1]

41. The diagram below shows birds.

Bird A



Bird B

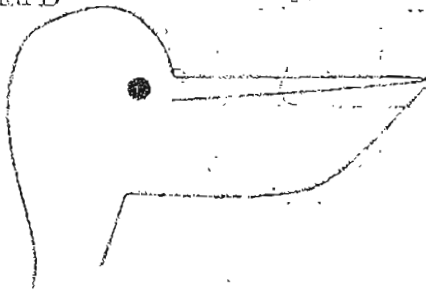

- (a) Draw lines to match the bird with the food they eat. [1]

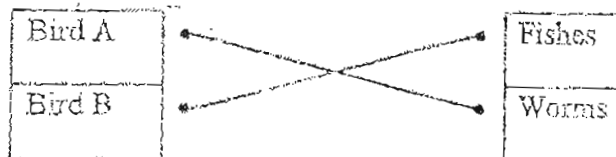

- (b) Explain how the beak of B is adapted to the bird's diet. [1]

42. List two reasons why polar bears are not adapted to live in the desert. [2]

a) _____

b) _____

43. Below shows the family tree of David.

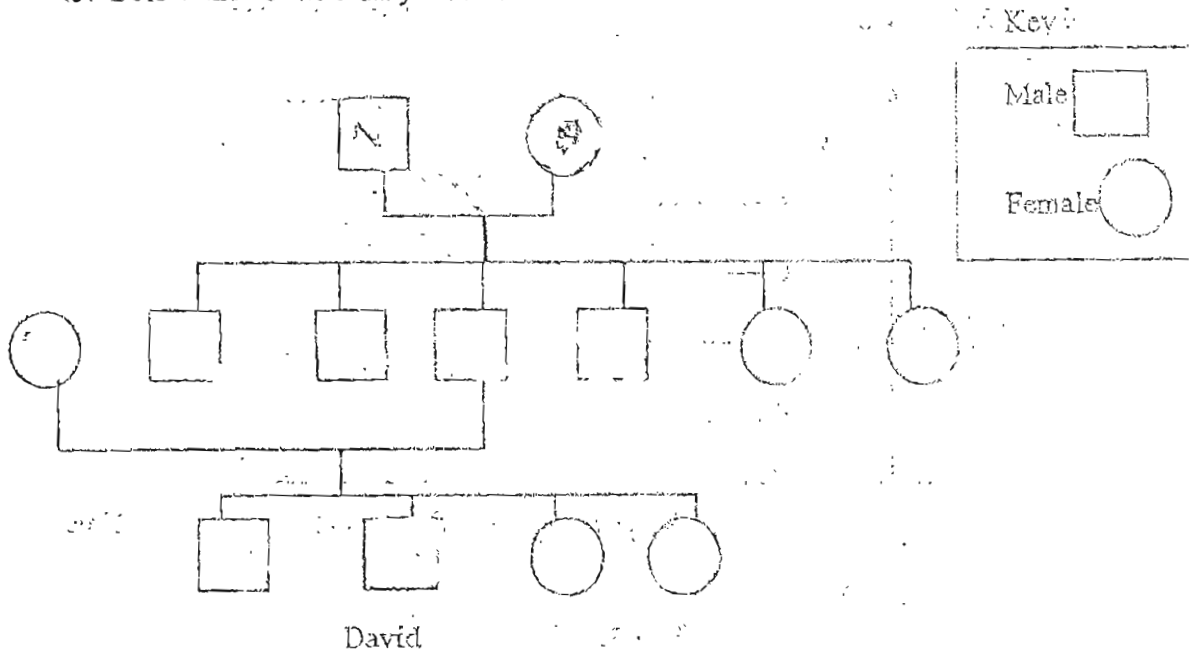

(a) How many uncles does David have? [1]

(b) Shade the figure that represents his grandmother in the family tree shown. [1]

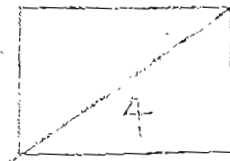

44. Study the food web below. A, B, C, D and E are animals.

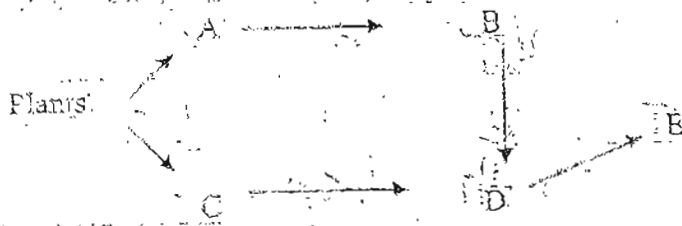

a) If population D is removed from the habitat, how will it affect the population of A, C and E? Draw the lines to show the change in population size. [3]

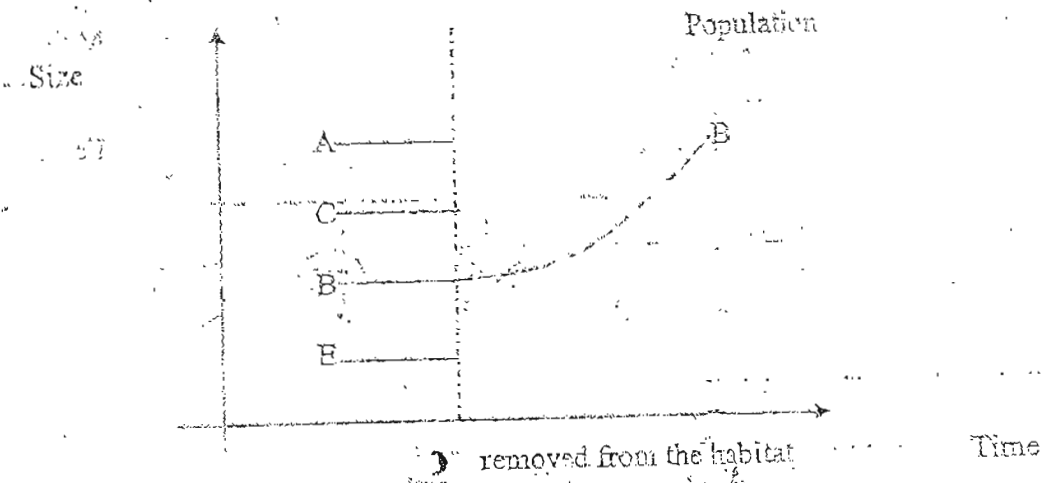

b) Explain why you draw line C this way. [2]

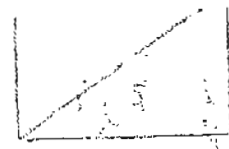

45. The pie chart below shows the number of living things expressed as a percentage in a community:

Look at the statements below. Base your answer only on what you can gather from the pie chart below. Put a tick in the correct column. [2]

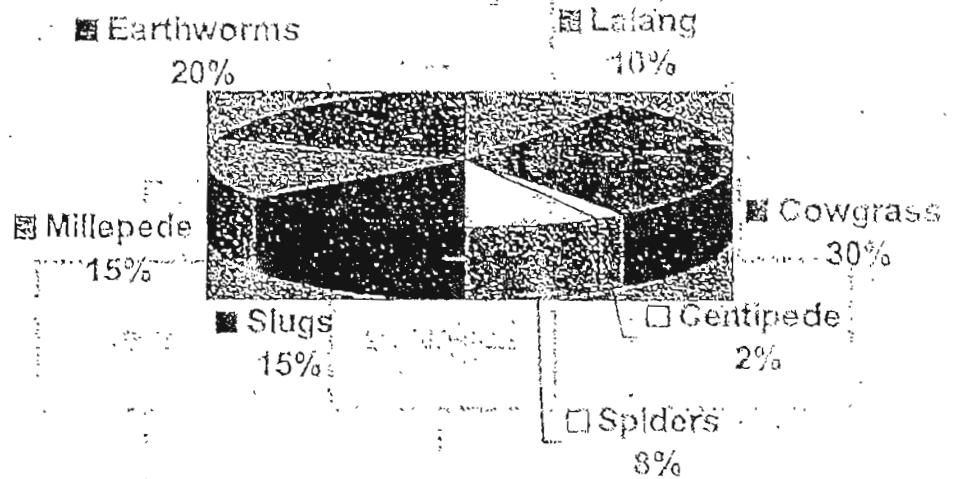

No.	Statements	True	False	Not possible to tell
1.	The population of the herbivores is 5 times the size of the carnivores.			
2.	These living organisms can be found in the garden.			
3.	The spiders prey on the ants.			
4.	There are 10% more food producers than food consumers.			

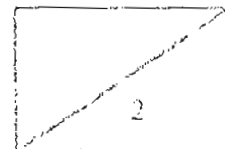

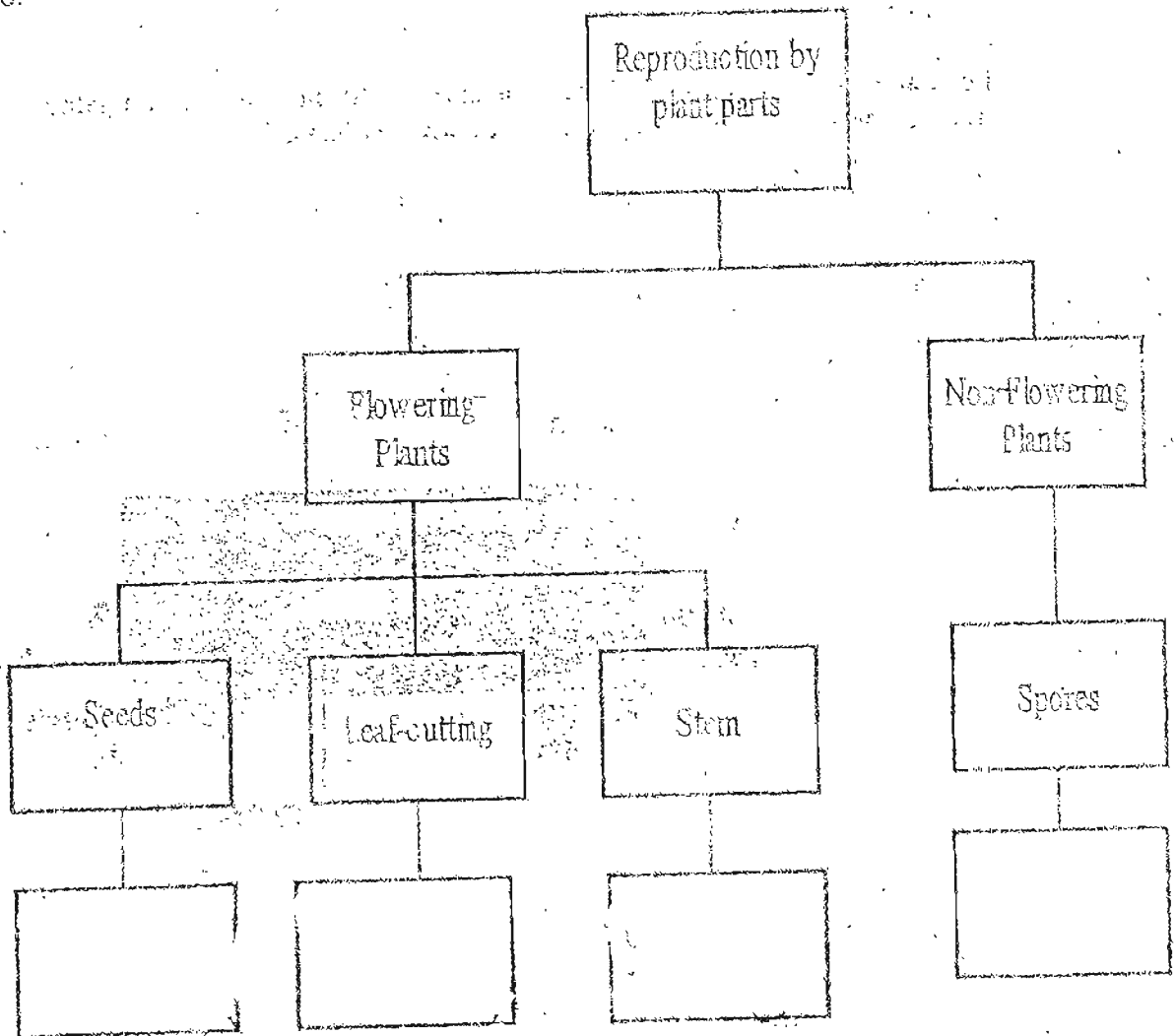

Put African Violet, onion, maiden hair fern and sansevieria in the appropriate boxes. [2]

