

CA1

TAO NAN SCHOOL
Primary 6 Science Mid-year Examination – 2004

Name : _____ ()
Class : Primary 6 ()
Parent's Signature : _____

Date : 10th May 2004
Duration : 1h 45mins
Marks : _____/100

Section A (30 × 2 marks)

For each question 1 to 30, four options are given. One of the four options is the correct answer. Select the correct answer and shade its corresponding oval (1, 2, 3 or 4) on the Optical Answer Sheet.

1. Which of the following about all non-flowering plants and fungi are correct?

		Non-flowering plants	Fungi
A	Contain chlorophyll?	Yes	No
B	Carry out respiration?	Yes	No
C	Reproduce by spores?	No	Yes
D	Feed on decaying matter?	No	Yes

- (1) A and D only
(2) B and C only
(3) A, C and D only
(4) A, B, C and D
2. The statements below describe a certain organism.

It is a carnivore.
It lives in a pond.
It breathes through breathing tubes.

Based on the description above, what can the organism be?

- (1) Dragonfly
(2) Pondskater
(3) Water stick insect
(4) Great diving Beetle

3. Study the classification chart below carefully.

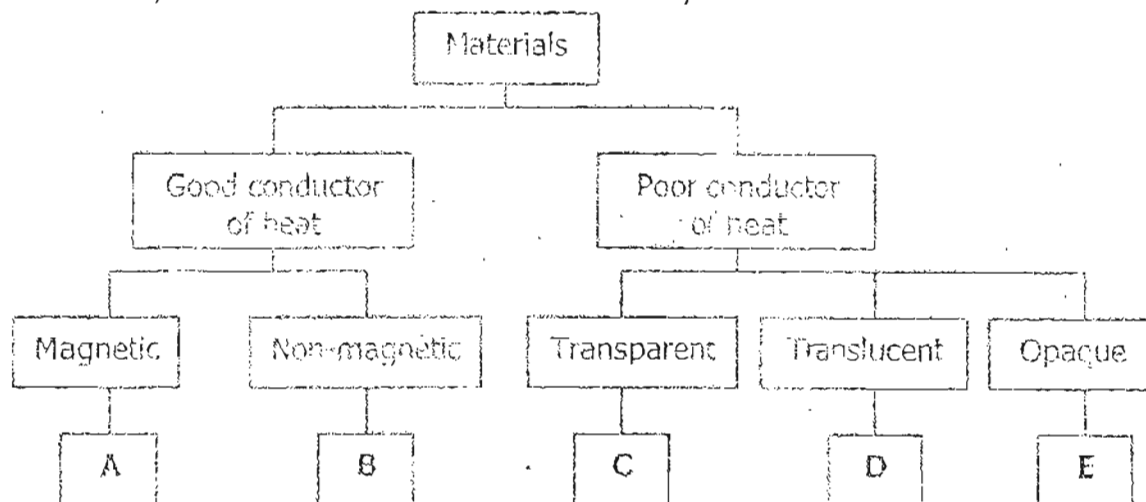

What can A, B, C, D and E be?

	A	B	C	D	E
(1)	steel ✓	copper	frosted glass	tinted glass	cloth
(2)	cobalt ✓	mercury	clear plastic	frosted glass	styrofoam
(3)	silver	nickel	tin	oil	leather
(4)	iron ✓	aluminium	water	canvas	Wood

4.



balloon



styrofoam cup



test tube



eraser



plastic ruler

Which of the following characteristics can be used to divide the objects shown above into two distinct groups?

- A : flexible and inflexible
- B : waterproof and non-waterproof
- C : float on water and sink in water

- (1) A and B only
- (2) A and C only
- (3) B and C only
- (4) A, B and C

5. The leaves of the plant "Muntingia calabura" is toothed-edged and has net veins. From the description given, which leaf below belongs to the "Muntingia calabura" plant?

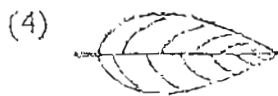
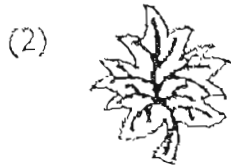

6. Use the table provided to classify the animal.



A.	Has legs Does not have legs	Go to B Go to C
B.	8 legs or less more than 8 legs	Go to E Go to F
C.	Body with no shell Body with a shell	Go to D Mollusc
D.	Body with rings Body without rings	Annelid Nematode
E.	6 legs 8 legs	Insect Arachnid
F.	All legs are of the same length Not all legs are of the same length	Myriapod Crustacean

Which class does the animal belong to?

- (1) Annelid
- (2) Arachnid
- (3) Myriapod
- (4) Crustacean

7. Which is the most important property to consider when choosing a material to make a tent pole?

- (1) Elastic
- (2) Strong
- (3) Flexible
- (4) Magnetic

8. Study the food chain below carefully.

A → B → C → D

Which of the following statements is definitely true?

- (1) A is a food producer.
- (2) B is a herbivore.
- (3) C is a carnivore.
- (4) D is an omnivore.

9. Matthew observed **Animal P** and made the following observations.

Animal P

- has no hair
- has no legs
- has no wings
- has scales
- has a backbone

In which class can **Animal P** be?

- (1) Fish
- (2) Insect
- (3) Mammal
- (4) Amphibian

10. Study the flow chart below carefully.

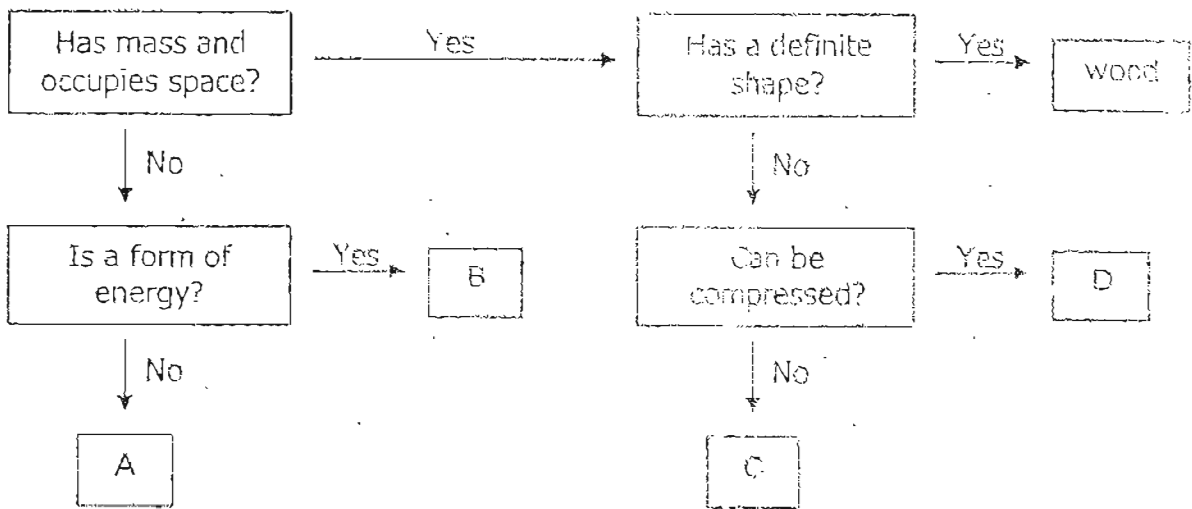

Which of the following matches the letters A, B, C and D?

	A	B	C	D
(1)	gravity	sound	sand	mist
(2)	wind	nitrogen	plasticine	oxygen
(3)	heat	magnetism	sponge	hydrogen
(4)	shadow	electricity	petrol	water vapour

11. Rachel carried out an experiment to see how the amount of carbon dioxide affects the rate of photosynthesis. Which one of the following correctly shows her results if she had carried out a fair test?

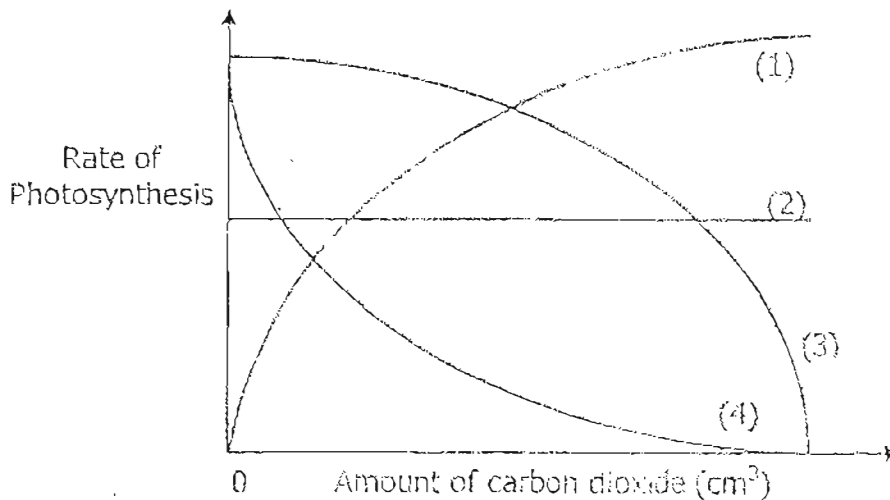

12. In which part of the digestive system is digested food absorbed into the bloodstream?

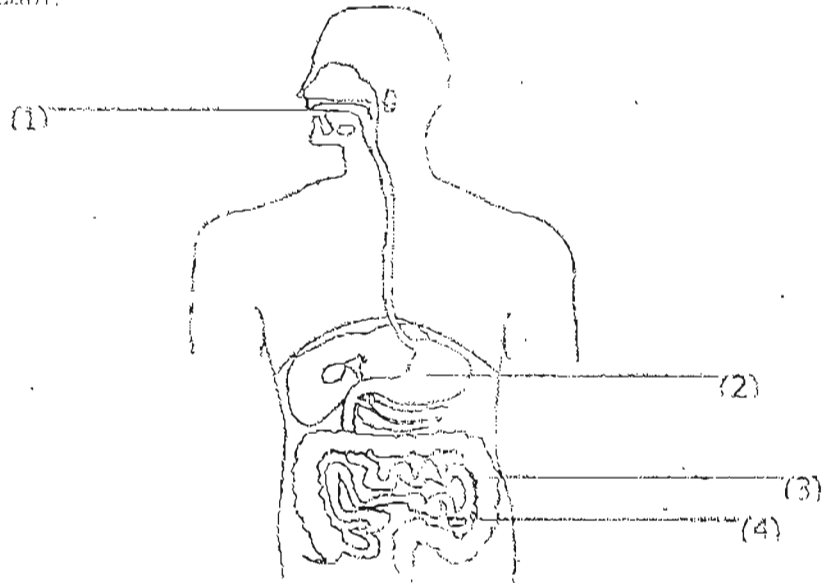

13. The diagram below shows the stages of growth of a plant.

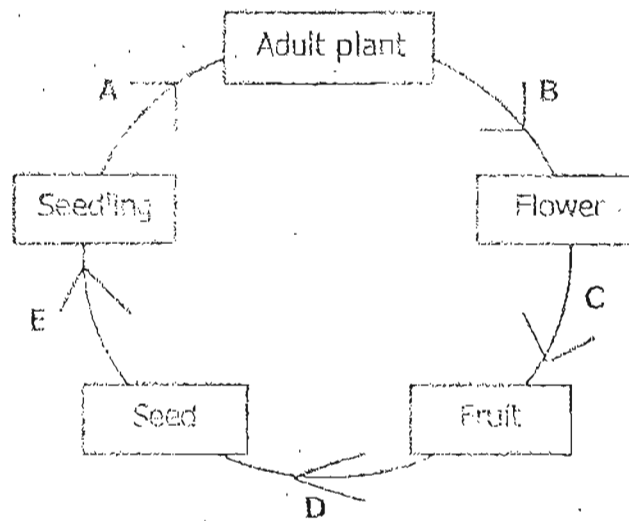

When do the processes of germination and fertilization take place?

	Germination	Fertilization
(1)	A	D
(2)	E	B
(3)	B	E
(4)	E	C

14. Equal amounts of iced water are poured into 4 similar cups. Each cup is made of a different material. The diagrams below show the temperature of the water in the 4 cups after 10 minutes. Which cup is the most suitable to keep the iced water cool for the longest period of time?

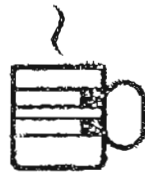

10°C
(1)



15°C
(2)



20°C
(3)



25°C
(4)

15. Which of the following graphs shows the effect of increased humidity on the rate of evaporation?

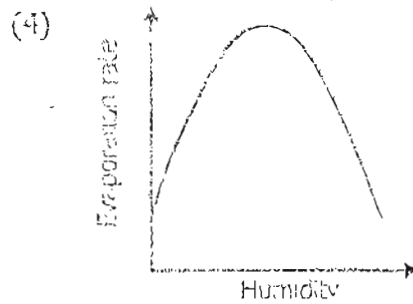
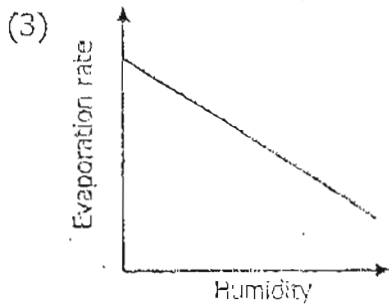
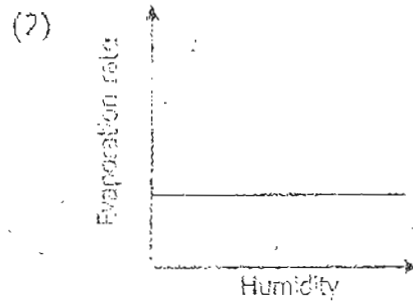
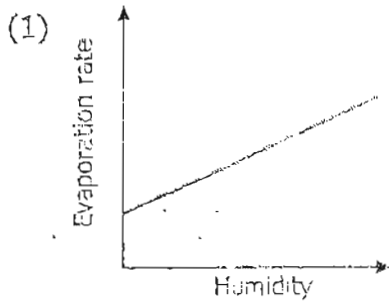

16. Which of the following are not true of plants that reproduce from leaves?

- A They bear flowers.
- B They grow on other plants for support.
- C They have buds that grow at the edges of the leaves or at the leaf stalk.

- (1) A only
- (2) B only
- (3) A and C only
- (4) B and C only

17. The diagram shows part of an island where two types of plants (▲, ■) are growing.

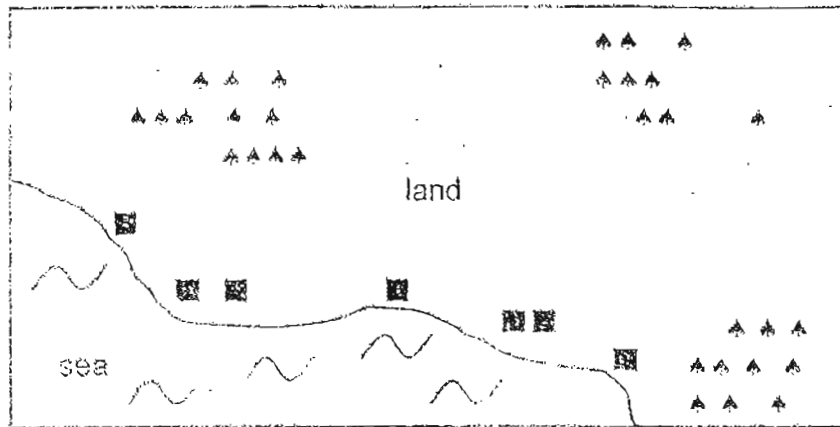

How are the fruits or seeds of the two types of plants most likely dispersed?

	▲	■
(1)	Water	Splitting
(2)	Splitting	Water
(3)	Wind	Water
(4)	Splitting	Animals

18. The four diagrams below show the different stages of development of a fruit. Arrange them in the correct order.

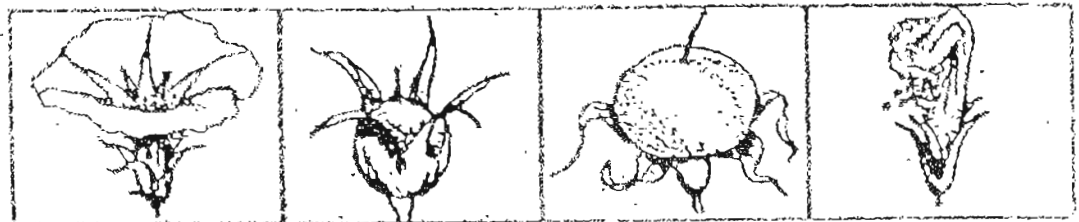

- A B C D
- (1) A, D, B, C
 (2) B, A, C, D
 (3) C, B, A, D
 (4) B, C, D, A

19. Gestation is the process of carrying a young unborn animal inside the mother's body for a period of time before birth. The table below shows the gestation period of mammals and the mass of their young when it is born.

Animal	Gestation (weeks)	Average mass of a new-born baby (kg)
Mouse	2.5	0.005
Cat	8	0.25
Pig	17	1.5
Human	40	3.5
Horse	?	35
Elephant	95	100

What is the most likely gestation period of a horse?

- (1) 27 weeks
 (2) 35 weeks
 (3) 49 weeks
 (4) 100 weeks
20. Which of the following statements about forces are true?
- A Gravitational force can act from a distance.
 B Magnets exert a magnetic force on magnetic objects.
 C The weight of an object depends on the gravitational force acting on it.
 D An object remains at a stationary position because no forces are acting on it.
- (1) A and C only
 (2) B and D only
 (3) A, B and C only
 (4) A, B, C and D
21. Which of the following is not an example of forces at work in nature?
- (1) Volcanoes erupting.
 (2) Fireworks exploding in the sky.
 (3) Windmills spinning in the wind.
 (4) A waterfall going over a mountain cliff.

22. A goalkeeper punches a ball away in a soccer game. Which of the following shows the effect of the force applied by the goalkeeper ?

- (1) The ball loses heat.
- (2) The ball slows down.
- (3) The ball stops moving
- (4) The ball changes direction.

23. The picture below shows a boy using a rope to climb a hill.

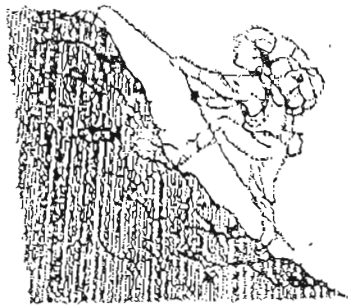

Which two forces help him to climb ?

- (1) friction and gravity
- (2) magnetic force and gravity
- (3) friction and the force exerted by the rope
- (4) the force exerted by the rope and magnetic force

24. Three thumbtacks, T, U and V are held onto an iron rod by some wax. The metal rod is then heated up by placing a candle at the position indicated by an arrow as shown below. Arrange the order in which the thumbtacks will drop, beginning with the thumbtack that will drop first.

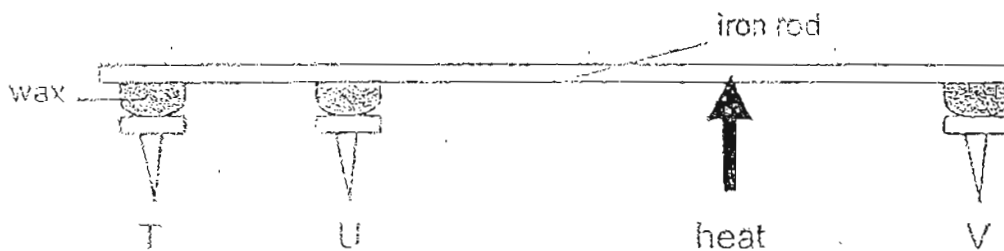

- (1) V, U, T
- (2) T, U, V
- (3) U, V, T
- (4) V, T, U

25. Which one of the following simple machines has its fulcrum, load and effort arranged in the same order as that of a wheelbarrow ?

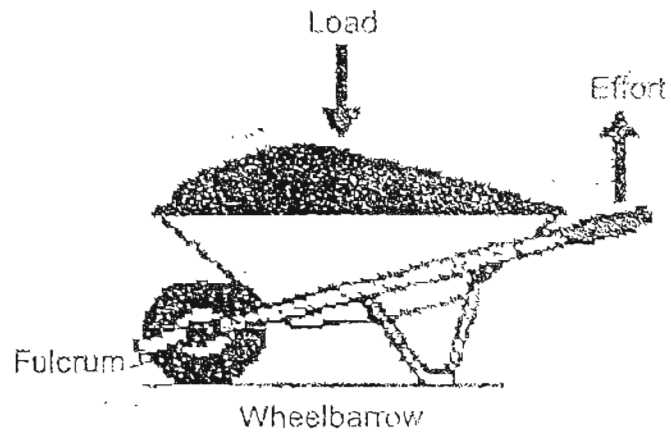

(1)

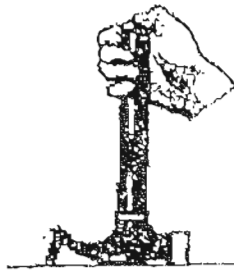

(2)



(3)

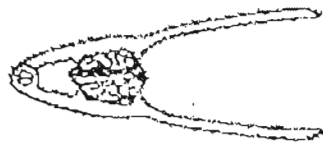

(4)



Ice cubes

26. Study the four diagrams below. Each diagram shows an object balanced by a weight of 100g on a lever.

Which of the objects below has the smallest mass ?

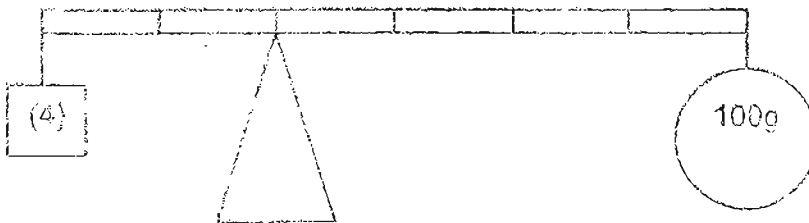
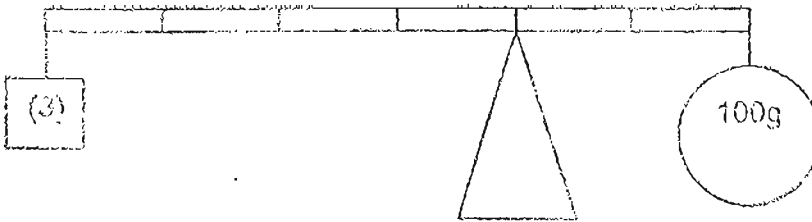
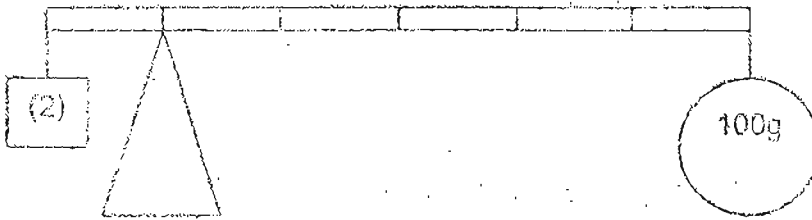
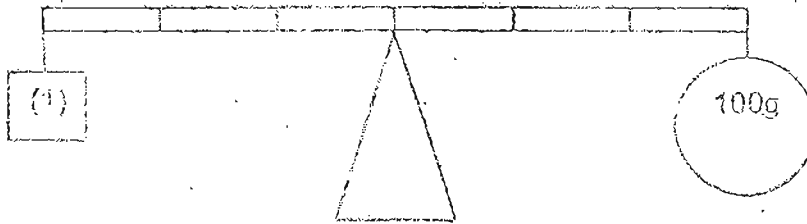

27. Look at the set-up below. The paper spiral began to spin soon after the circuit was connected.

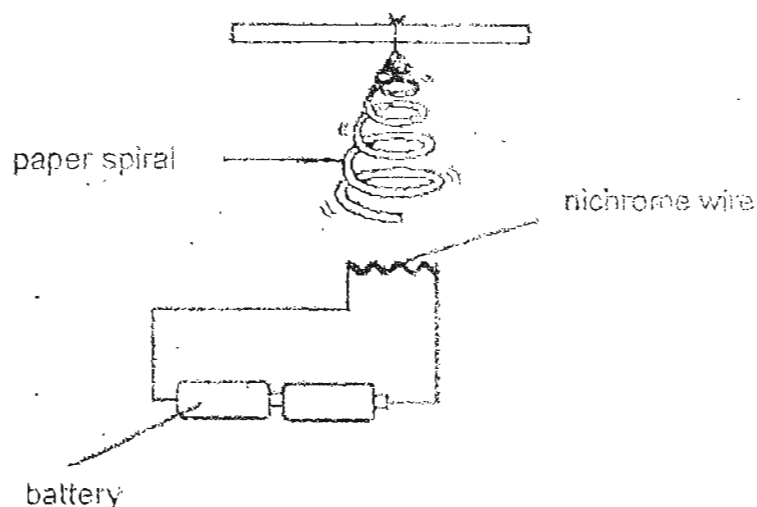

Which of the following correctly describes the energy changes ?

- (1) chemical potential energy \longrightarrow heat energy + light energy \longrightarrow kinetic energy
- (2) chemical potential energy \longrightarrow kinetic energy \longrightarrow heat energy + light energy
- (3) chemical potential energy \longrightarrow electrical energy \longrightarrow kinetic energy + heat energy
- (4) chemical potential energy \longrightarrow electrical energy \longrightarrow heat energy + light energy \longrightarrow kinetic energy

28. The graphic organiser below shows the conversion of electricity to other forms of energy, W, X, Y and Z, by some household electrical appliances.

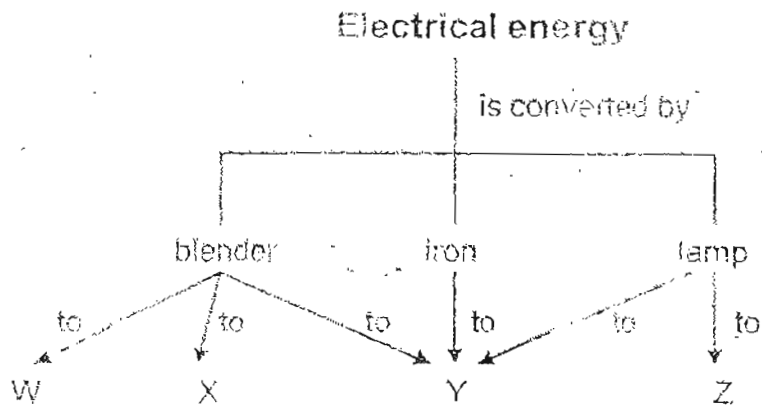

Which of the following completes the above diagram?

	W	X	Y	Z
(1)	kinetic	sound	heat	light
(2)	kinetic	potential	light	heat
(3)	sound	chemical	heat	light
(4)	heat	light	sound	kinetic

29. Study the classification table below.

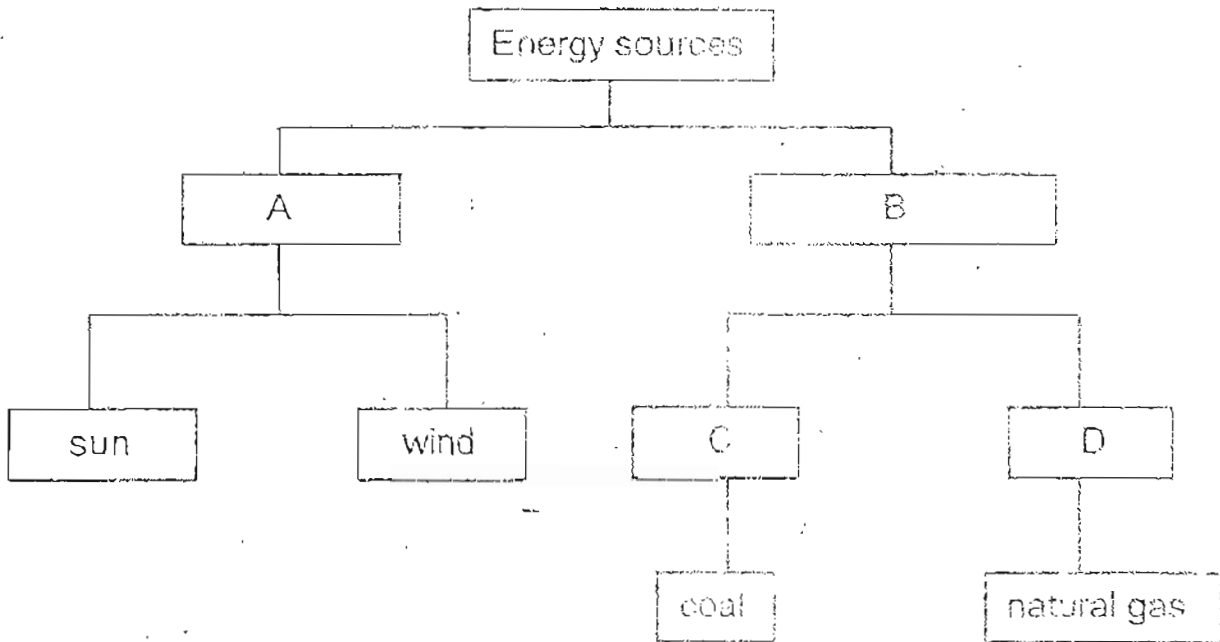

Match the headings A, B, C and D with the correct words.

	A	B	C	D
(1)	natural	artificial	liquid	gas
(2)	renewable	non-renewable	solid	gas
(3)	wildlife	from the ground	liquid	gas
(4)	renewable	non-renewable	solid	liquid

30. Michelle sets up an experiment to find out how much light is allowed to pass through materials X, Y and Z. When a torch is shone, she observed the following on the screen.

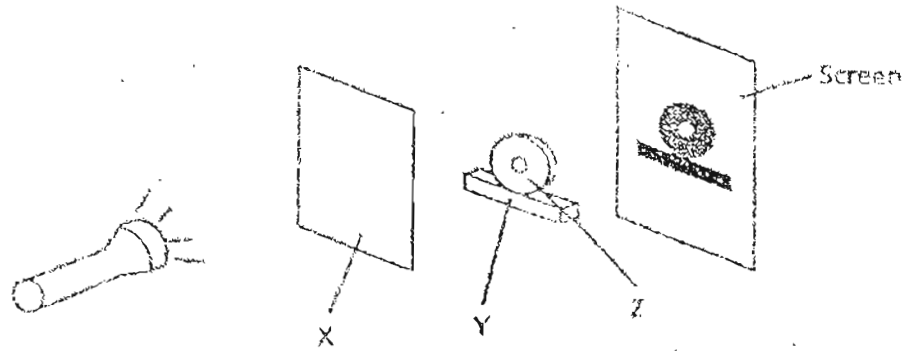

Which of the following sets of properties is correctly matched to the above materials?

	Material X	Material Y	Material Z
(1)	Allows most light to pass through	Allows some light to pass through	Does not allow any light to pass through at all
(2)	Allows some light to pass through	Allows most light to pass through	Does not allow any light to pass through at all
(3)	Allows most light to pass through	Does not allow any light to pass through at all	Allows some light to pass through
(4)	Does not allow any light to pass through at all	Allows most light to pass through	Allows some light to pass through

Section B (40 marks)

Write your answers for question 31 to 46 in the spaces provided.

31. Study the diagrams below carefully.

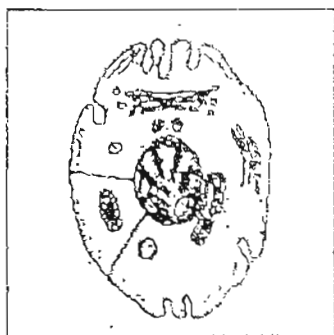

Cell A

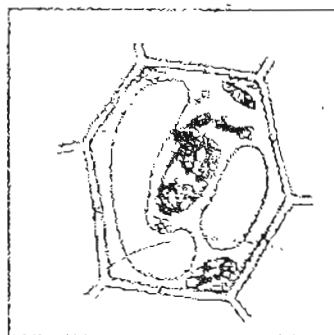

Cell B

(a) Which one of them is a plant cell? [1]

Cell _____

(b) Explain how you identified the plant cell. [2]

32. Study the diagram of the water cycle shown below carefully. [3]

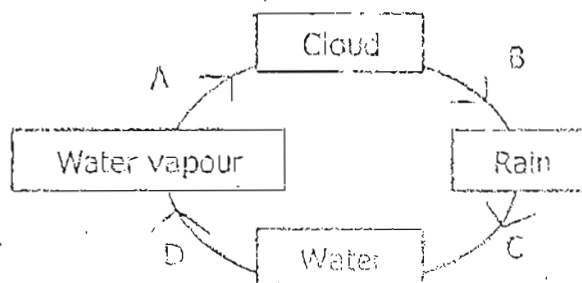

Fill in with the letters A, B, C and D depicting the processes of the water cycle. Each letter can only be used once.

(a) Change from liquid state to gaseous state : _____

(b) Change from gaseous state to liquid state : _____

(c) No change in state : _____

33. Sheryl recorded the number of organisms she observed in a pond community.

Organism	Number
A	5
B	10
C	20
D	35

The smallest population was an insect that spends part of its lifecycle in water. It is found at the bottom of the pond. The largest population was a fully submerged plant. There were more water fleas than tadpoles.

Identify the organisms from the information given. [2]

Organism	Name of organism
A	
B	
C	
D	

34. The diagram below shows the 4 stages in the life cycle of an organism.

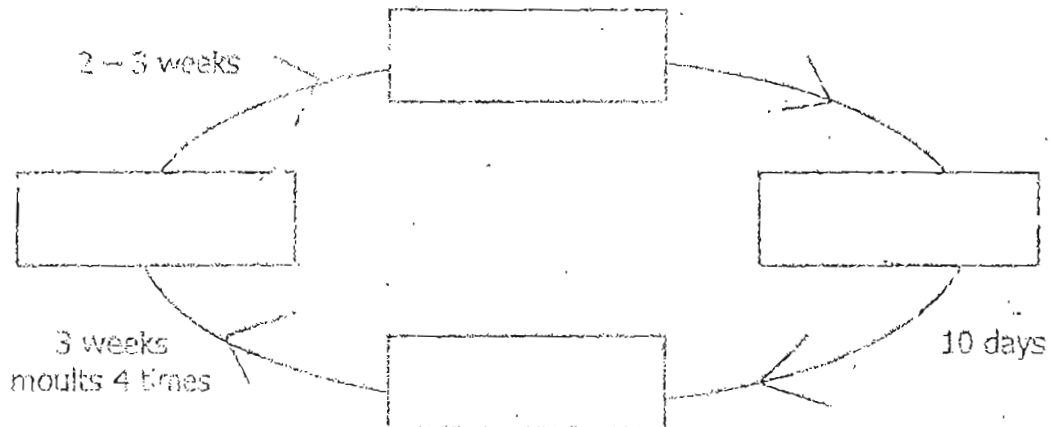

- a) Fill in the boxes with the appropriate stages in the life cycle of the organism. [2]
- b) At which stage of the life cycle of the organism can it reproduce? [1]

35. Read the following carefully.

- A : The lungs expand.
- B : The air goes into the lungs.
- C : Air goes through the nose.
- D : The air goes into the windpipe.
- E : Hairs in the nose trap dust and dirt present in the air.

Arrange them in the correct order to describe what happens during physical breathing. The first one has been done for you. [2]



36. Foxes, rabbits, cats and sheep are animal species introduced into Australia by humans. These introduced species can endanger native animals. They are either predators or animals that compete with native animals for food.

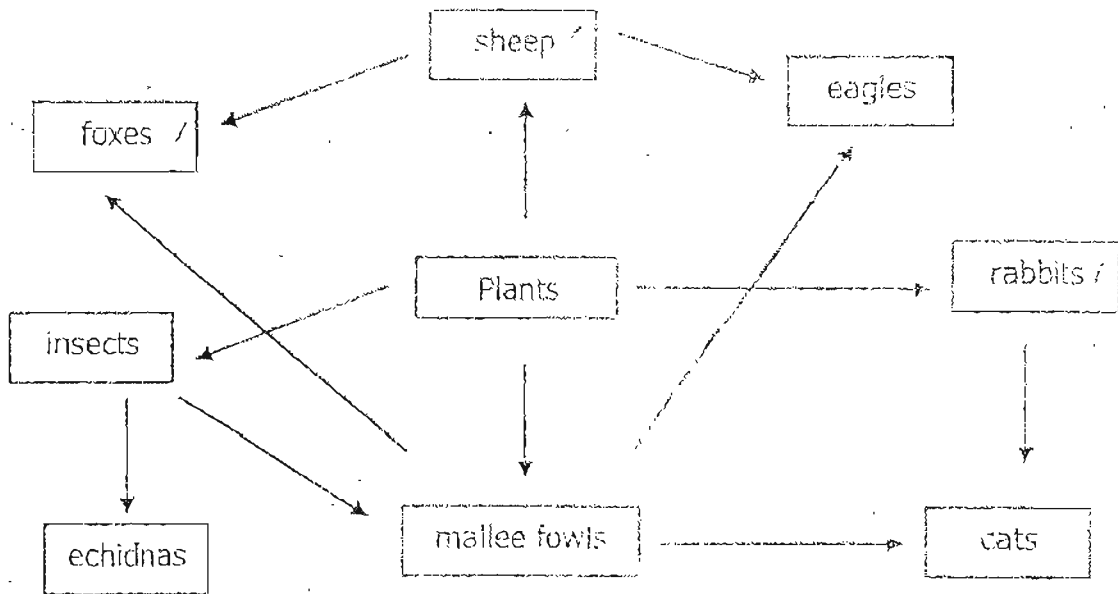

Study the food web above carefully to answer the questions below.

a) Which introduced animals compete with the mallee fowl for food? [1]

b) Which introduced animals are predators of the mallee fowl? [1]

37. Study the food web below carefully.

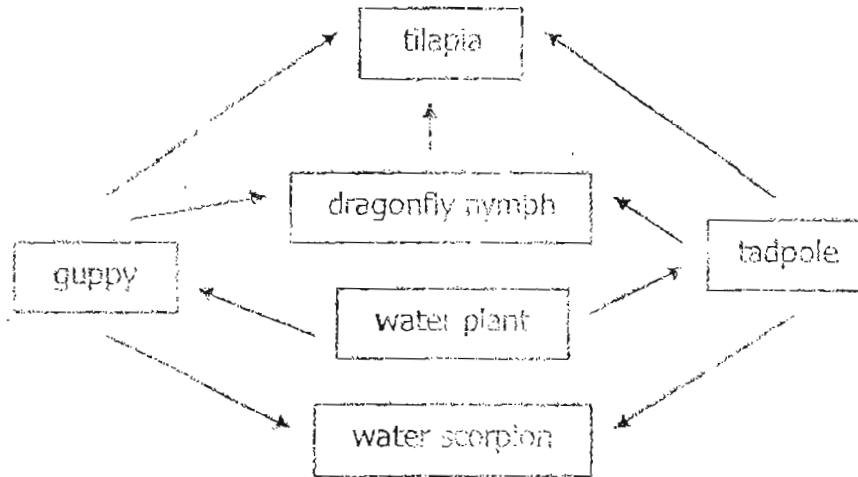

(a) If all the water plants were removed, what would be the immediate effect on the food web?

(b) Which population(s) would be the last to feel the effect? [1]

38. Fill in the classification table with the helping words given. [2]

Helping Words			
Toad	Whale	Eagle	Cat

	One at a time	More than one at a time
Lay eggs		
Give birth to young alive		

39. Magnet A is hung from a spring as shown in Diagram 1. Magnet B is then placed on the ground, directly below Magnet A as shown in Diagram 2.

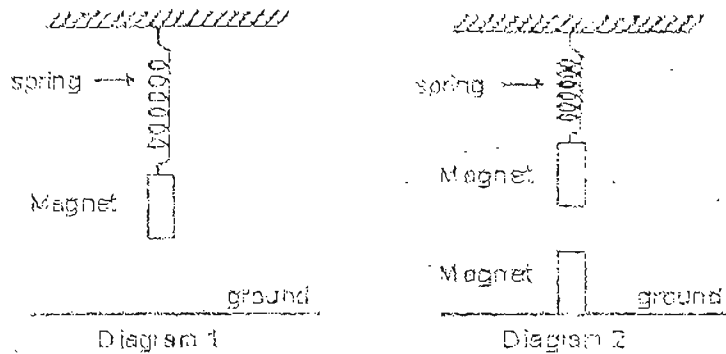

Explain why the spring stretches less in the arrangement shown in Diagram 2. [2]

40. John made a jumping toy using two pieces of plastic cards and a rubber band. He stretched the rubber band and released the toy. The toy snapped and jumped up to a certain height, which John measured and recorded in the table below.

Number of rubber bands used	Height jumped in (cm)		Average Height
	1 st try	2 nd try	
1	10	12	11
2	22	26	24
3	30	28	29

- (a) What is the relationship between the number of rubber bands used and the average height? [2]

- (b) Why must John repeat the activity and calculate the average of the heights jumped? [1]

41. State the main energy changes when a battery is used to run a fan as shown in the diagram below. [3]

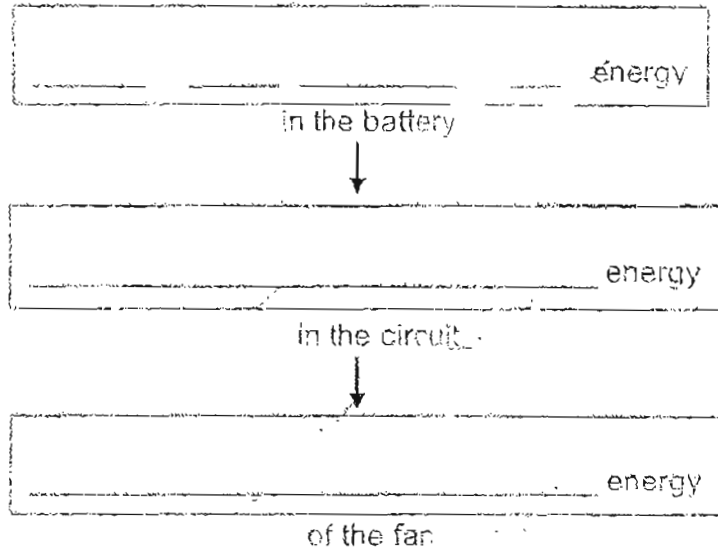
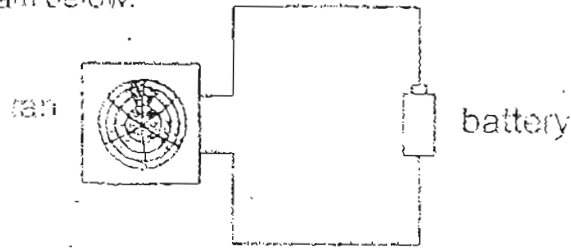

42. Gear A is connected to gear B and gear C as shown below.

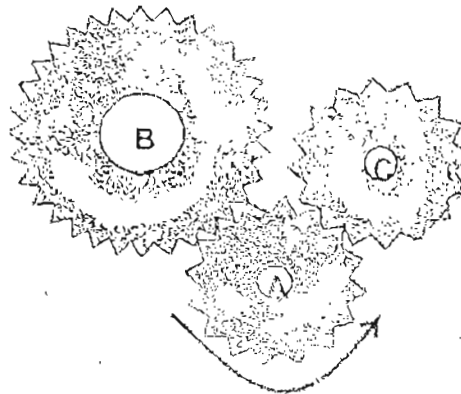

- (a) Gear A turns in an anti-clockwise direction. Indicate in the diagram above, the direction gears B and C turn. [1]
- (b) Gear B has twice the number of teeth as Gear A. If gear A turns 20 complete rounds, how many rounds will Gear B turn? [1]

43. Jason wanted to find out how the mass of an object affects the extension of a rubber band. He used similar rubber bands in the following experiment.

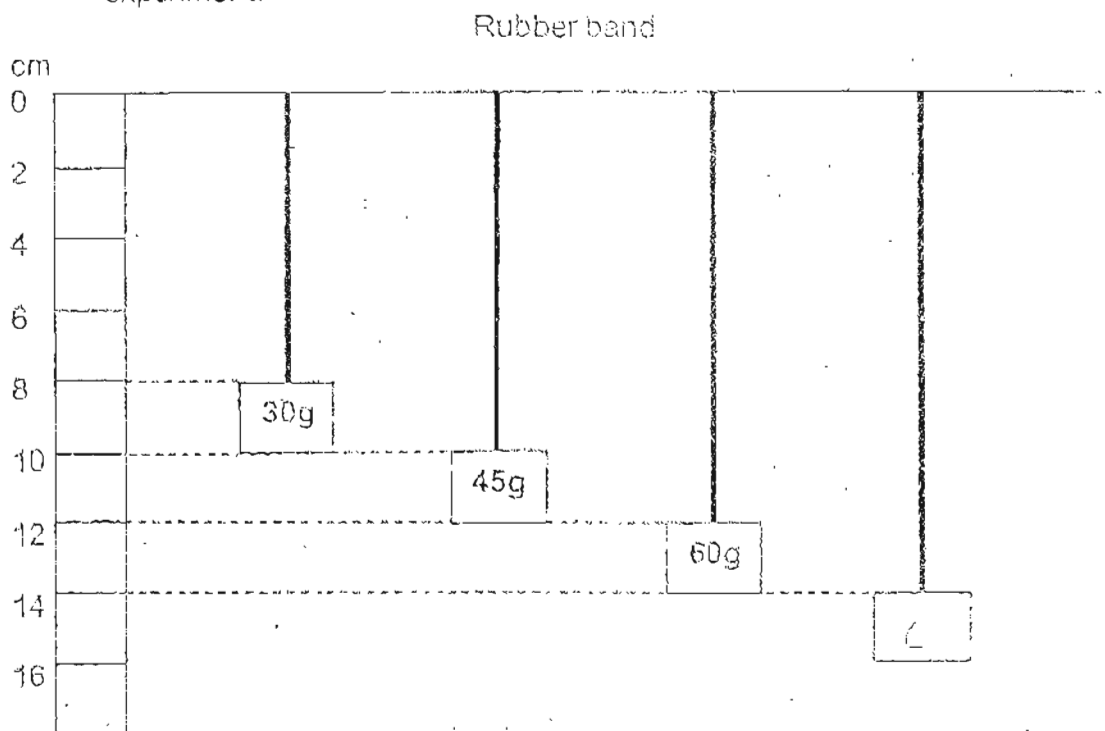

- (a) Based on the above set-up, what is mass of object C? [1]

- (b) What is the original length of the rubber bands? [1]

44. The diagram below shows a pulley system consisting of a fixed pulley and a movable pulley.

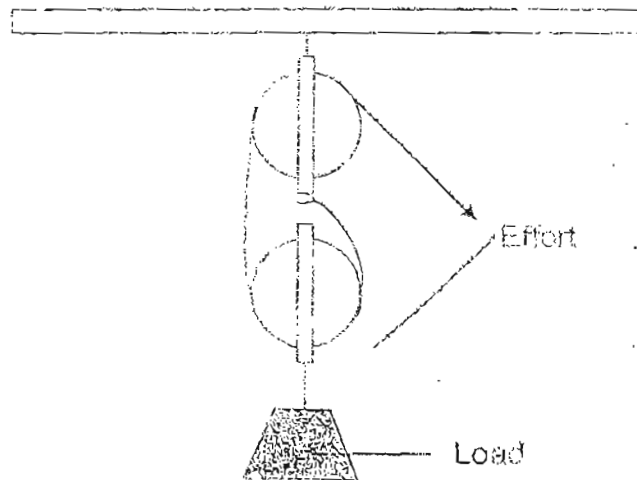

- (a) Complete the diagram by drawing in the string that connect the two pulleys so as to lift the load. [1]
- (b) State two advantages in using this pulley system. [2]

(i) _____

(ii) _____

45. Substance X was heated over a flame for a period of time and left to cool. The graph below shows the change in temperature of substance X. Use the information in the graph to answer the following questions.

Change in temperature of substance X

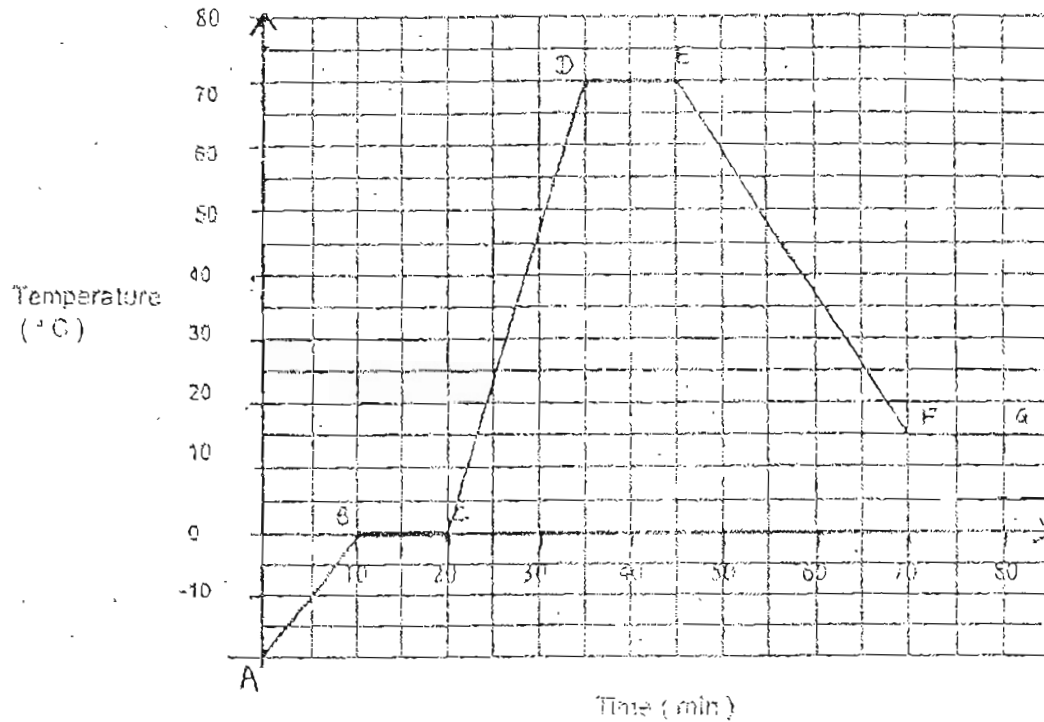

- (a) At which point was the source of heat removed from substance X? [1]
-
- (b) What was the room temperature? [1]
-
- (c) Identify the process at BC. [1]
-
- (d) Identify the state of substance X at AB. [1]
-

46. The flow chart below shows what happens to the refuse that is taken to Senoko Incineration Plant.

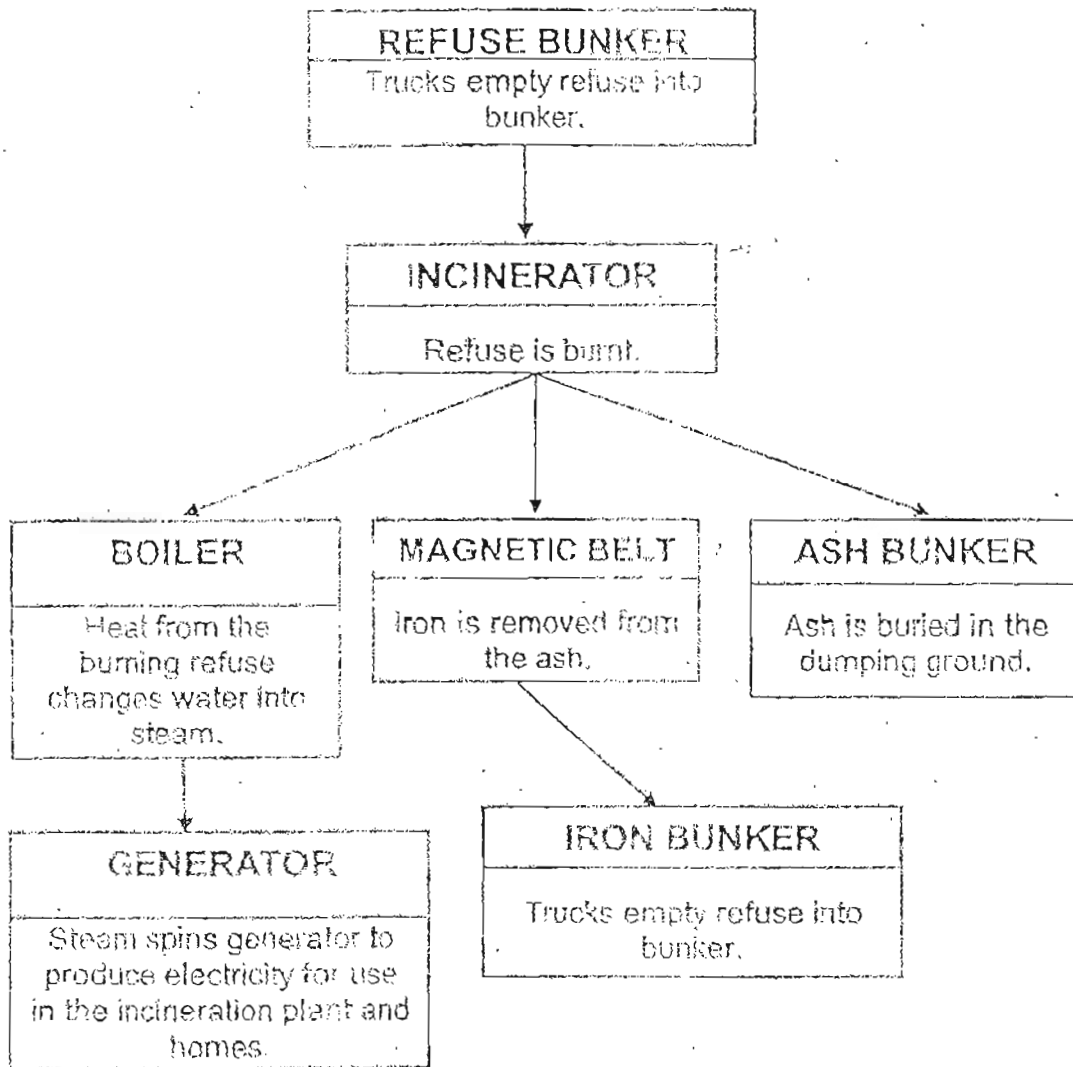

- (a) Based on the flow chart, state one advantage of disposing refuse through burning. [1]

- (b) State one disadvantage of using refuse as an energy source. [1]

TAO NAN SCHOOL
PRIMARY 6
MID YEAR EXAMINATION - 2004
SCIENCE

- 1) 3 27) 4
2) 3 28) 1
3) 2 29) 2
4) 2 30) 3
5) 1 31) a) B
6) 3 b) It has a cell wall, chloroplasts and a large vacuole.
7) 2 32) a) D
8) 1 b) A
9) 1 c) B, C
10) 4 33) dragonfly, nymph
11) 1 tadpoles
12) 4 water fleas
13) 4 hydrilla
14) 1 34) a) adult
15) 3 pupa Egg
16) 2 larva
17) 2 b) Adult stage
18) 1 35) C E D B
19) 3 36) a) Rabbits and sheep
20) 3 b) Cats and foxes
21) 2 37) a) Tadpole and guppy population would fall.
22) 4 b) Tilapia
23) 3 38) Eagle Toad
24) 1 Whale Cat
25) 3 39) Magnet A's south pole might have been facing Magnet B's south pole or vice versa and since like poles repel, Magnetic A was pushed up by a magnetic force.
26) 3

40) a) The average height increased as the number of rubber bands used increased.

b) To ensure a reliable result.

41) Chemical potential

Electrical

Kinetic

42) a)

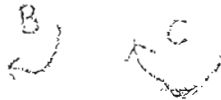

b) 10 complete rounds

43) a) 75 g

b) 4 cm

44) a)



b) i) It changes the direction of a force.

ii) It enables a smaller effort to overcome a bigger load.

45) a) E

b) 15 °C

c) Melting

d) Solid.

46) a) Steam spins generator to produce electricity to use in the incineration plant and homes.

b) It gives out smoke and gas, causing air pollution.