

ANGLO-CHINESE SCHOOL  
(JUNIOR)



SEMESTRAL ASSESSMENT 1 (2011)  
PRIMARY 6

SCIENCE

BOOKLET A

Wednesday

11 May 2011

1 hour 45 minutes

Name : \_\_\_\_\_ ( )

Class : P6 \_\_\_\_\_

**INSTRUCTIONS TO PUPILS**

**DO NOT TURN OVER THE PAGES UNTIL YOU ARE TOLD TO DO SO**

Follow all instructions carefully.

There are 30 questions in this booklet.

Answer **ALL** questions.

**INFORMATION FOR PUPILS**

The total marks for this booklet is 60.

The total time for Booklets A and B is 1 hour 45 minutes.

**This question paper consists of 18 printed pages. (Inclusive of cover page)**

**Section A (60 marks)**

For each question from 1 to 30, four options are given. One of them is the correct answer. Choose the correct option (1, 2, 3 or 4) and shade the correct oval on the Optical Answer Sheet (OAS) provided.

1 The classification chart shows how some things are classified.

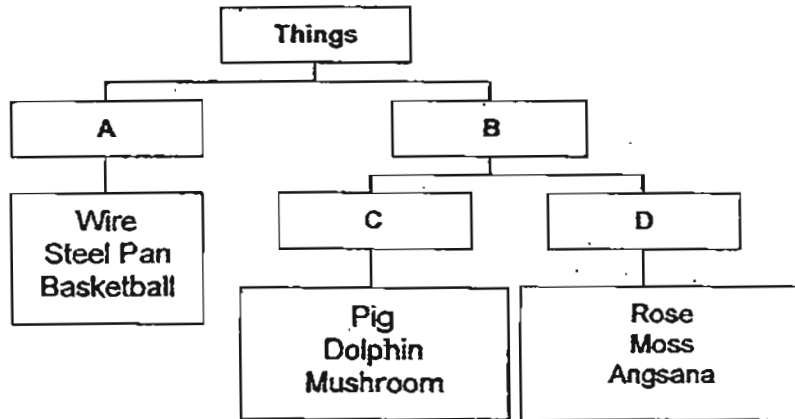

In which box, A, B, C or D, should we place the sub-heading "Food Producers"?

- (1) A
- (2) B
- (3) C
- (4) D

2 The table below shows the state of four different substances, A, B, C and D, at different temperatures.

Substance	State of substance at 20°C	State of substance at 50°C	State of substance at 90°C
A	Liquid	Gaseous	Gaseous
B	Solid	Solid	Liquid
C	Liquid	Liquid	Gaseous
D	Solid	Liquid	Liquid

Which substance has the highest melting point?

- (1) A
- (2) B
- (3) C
- (4) D

- 3 Wain was given 4 freshly laid eggs from 4 different animals and told to observe their development. He recorded his observations.

Observations	
•	The egg of the housefly hatched first.
•	The egg of the butterfly hatched after the egg of the platypus.
•	The egg of the platypus hatched before the egg of the pigeon.

He then recorded the time taken for the eggs to hatch into their young in the graph below.

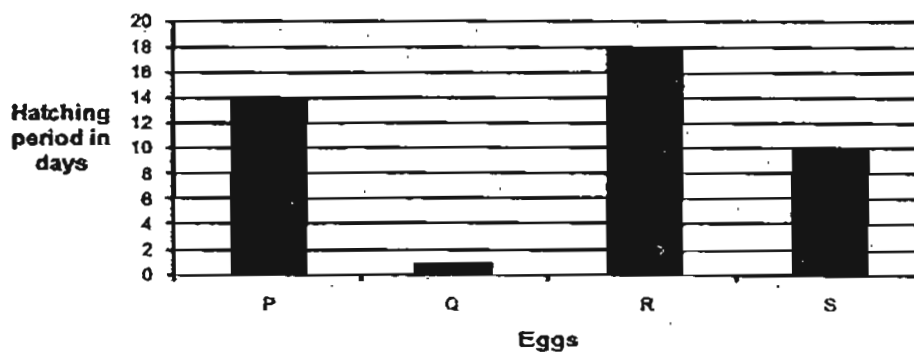

Which one of the eggs hatched into a platypus?

- (1) P
- (2) Q
- (3) R
- (4) S

- 4 The table below shows the description of 4 children.

Name of child	Description of child
Amos	has attached earlobes
Ben	has short blonde hair
Carol	has long fingernails
Dawn	can roll her tongue

Which of the 4 children inherited these character traits from their parents?

- (1) Ben and Dawn only
- (2) Amos and Carol only
- (3) Amos, Ben and Dawn only
- (4) Amos, Ben, Carol and Dawn

- 5 Jerry has 2 flowers, X and Y, of the same species. The diagram below shows one of the flowers.

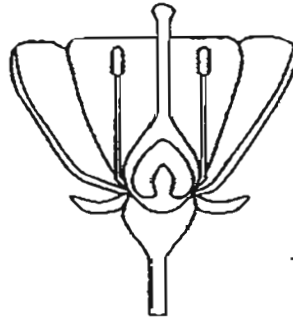

Some parts of the flowers were removed. The diagram below shows the two flowers with some parts removed.



Flower X

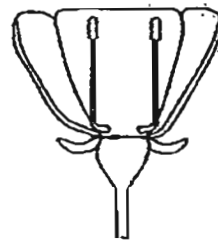

Flower Y

Explain why pollination could take place between flowers X and Y.

- (1) One of two flowers has both the female and male reproduction parts in it.
- (2) The petals of one of the flowers were removed :
- (3) Flowers X and Y have the female and male reproduction parts respectively for pollination.
- (4) Both flowers have either only the female reproduction part or the male reproduction part.

6 Study Jovan's family tree below.

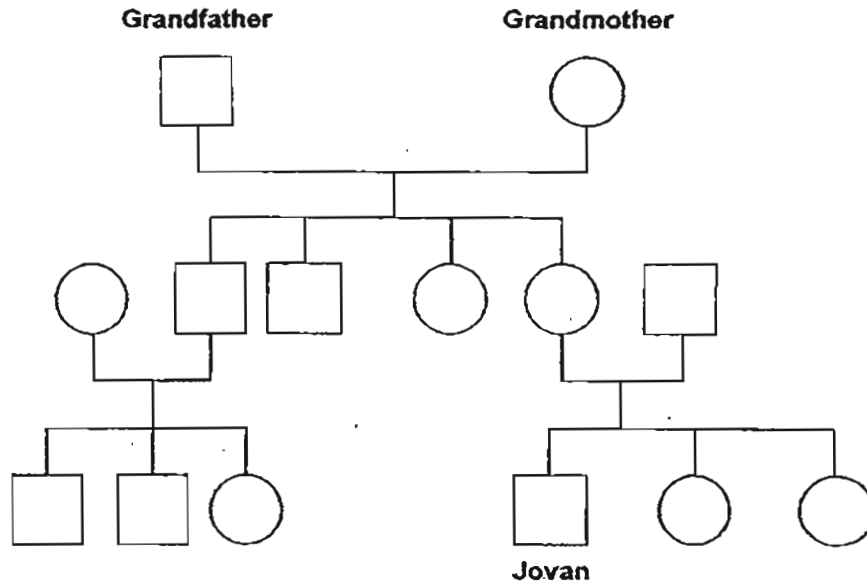

How many brother(s) does Jovan's mother have?

- (1) 0
- (2) 1
- (3) 2
- (4) 3

7 Which of the following actions do not help to conserve water?

- A Using a hose to water plants
- B Brushing teeth with a mug of water
- C Using collected rainwater to wash toilet
- D Washing vegetables under running tap water

- (1) A and D only
- (2) B and C only
- (3) A, C and D only
- (4) A, B and D only

8 Mrs Tham packed some hot soup into a container for her lunch break. Before she left for work, she observed that water droplets were formed on the enclosed container.

Which one of the diagrams correctly shows Mrs Tham's observation?

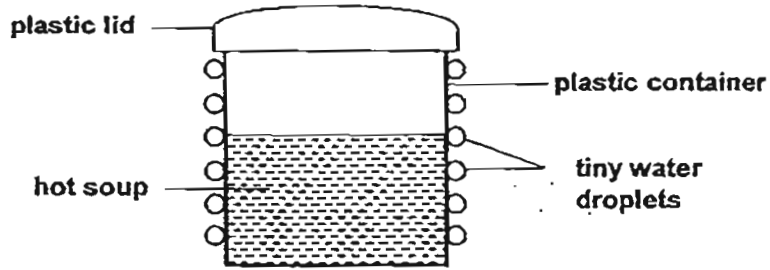
(1)  **plastic lid** **plastic container** **hot soup** **tiny water droplets**

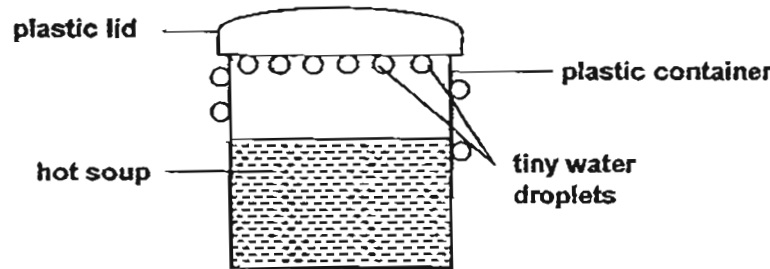
(2)  **plastic lid** **plastic container** **hot soup** **tiny water droplets**

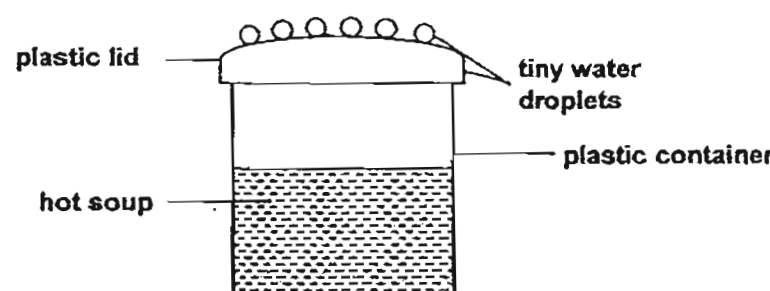
(3)  **plastic lid** **plastic container** **hot soup** **tiny water droplets**

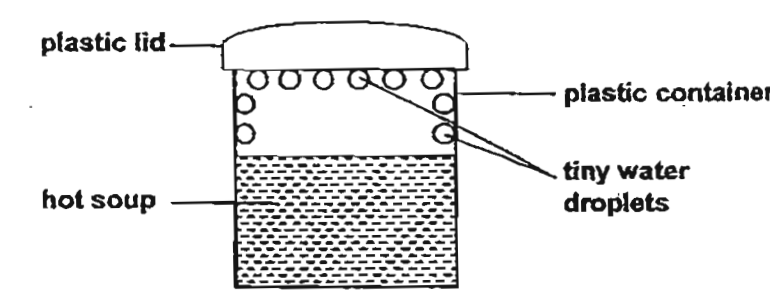
(4)  **plastic lid** **plastic container** **hot soup** **tiny water droplets**

9 Which of the following animal(s) has/have a skeletal system?



Animal A



Animal B



Animal C

- (1) A only
- (2) C only
- (3) B and C only
- (4) A, B and C

10 Jessica has just opened a floral shop. Which of the following can help Jessica keep her flowers alive for a longer period of time?

- (1) Hang the flowers upside down under the Sun.
- (2) Place the petals of the flowers in a container of water.
- (3) Wrap the flowers in dry plastic bags and place them in an airy location.
- (4) Cut the lower part of the stems of the flowers at an angle less than 90° and then place the lower part of the stems in a container of water.

11 The table below records some observations of Jason's breathing during the school hours.

Activity	Number of breaths in 15 seconds	Volume of air exchanged for each breath in 15 seconds (litres)
P	7	2.9
Q	4	1.8
R	2	0.7

Which of the following activities are best represented by P, Q and R?

	P	Q	R
(1)	Strolling to classroom	Walking up the stairs	Running around the track
(2)	Strolling to classroom	Running around the track	Walking up the stairs
(3)	Walking up the stairs	Strolling to classroom	Running around the track
(4)	Running around the track	Walking up the stairs	Strolling to classroom

12 The diagram below shows the human circulatory system.

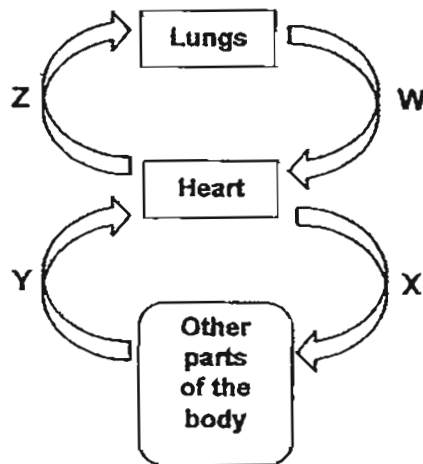

Which arrows show the flow of blood that is rich in carbon dioxide?

- (1) W and X only
- (2) Y and Z only
- (3) W, X and Y only
- (4) W, X, Y and Z

13 Luke identified the parts of 4 different cells and the information is recorded in the table below.

Cell	Cell parts identified
P	cytoplasm, cell membrane
Q	chloroplasts, cell membrane
R	nucleus, cytoplasm, cell membrane
S	nucleus, cytoplasm, cell membrane, cell wall

Which cells are definitely plant cells?

- (1) P and Q only
- (2) R and S only
- (3) Q and S only
- (4) P and R only



14 The diagram below shows an open circuit.

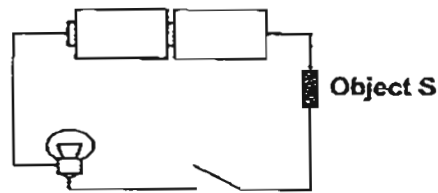

When the circuit is closed, the light bulb does not light up at all.

What could be the possible reasons?

- A The light bulb has fused.
- B Object S is a plastic ruler.
- C The batteries are too strong.
- D Object S is an insulator of electricity.
- E The arrangement of batteries is incorrect.

- (1) A, B and D only
- (2) B, C and D only
- (3) A, C, D and E only
- (4) A, B, C and E only

15 In the circuit below, which of the switch(es) should be left open and which switch(es) should be closed so that both bulbs A and B light up at the same time?

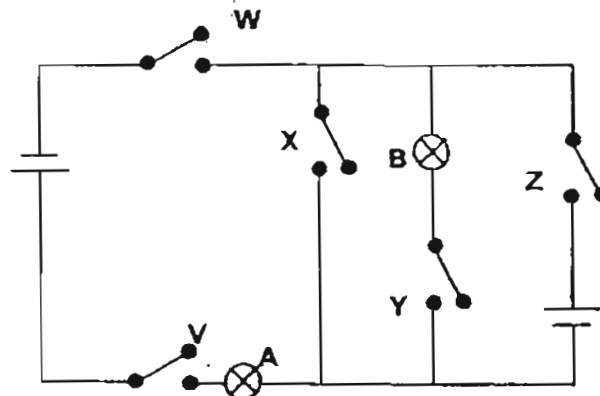

	Switch V	Switch W	Switch X	Switch Y	Switch Z
(1)	Closed	Closed	Open	Closed	Open
(2)	Closed	Closed	Open	Open	Closed
(3)	Open	Open	Closed	Open	Open
(4)	Open	Open	Closed	Open	Closed

16 Jeremy used 3 different objects, P, Q and R, to make the following cut-outs as shown below.

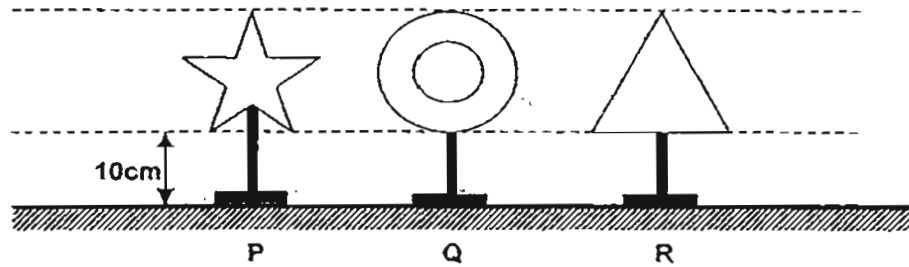

He placed the cut-outs between a lighted torch and screen. The diagram below shows how the cut-outs were arranged.

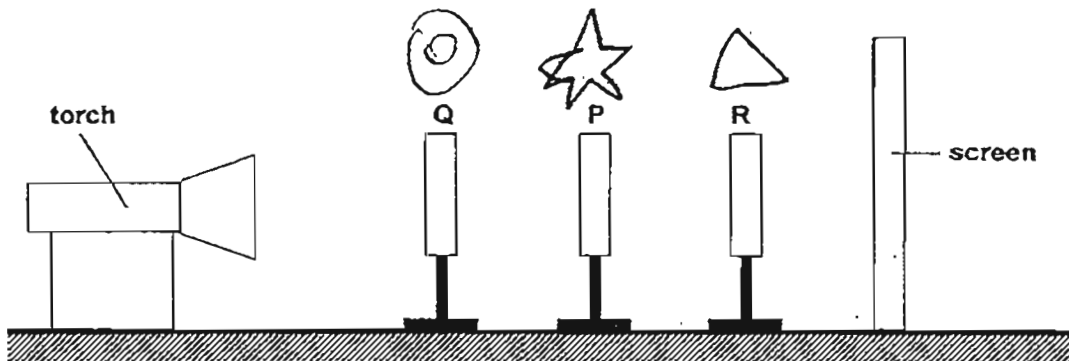

The diagram below shows the shadow formed on the screen.

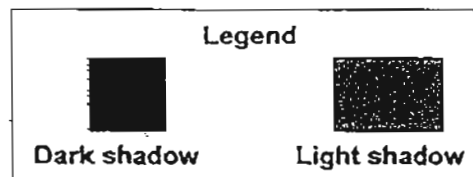

Which of the following could be P, Q and R?

	P	Q	R
(1)	tracing paper	cardboard	glass
(2)	glass	tracing paper	cardboard
(3)	tracing paper	glass	cardboard
(4)	glass	cardboard	tracing paper

- 17 Mrs Ng took a packet of milk from the refrigerator and warmed it up in a container of hot water. Which one of the graphs below shows the correct temperature change in the milk and the water eventually?

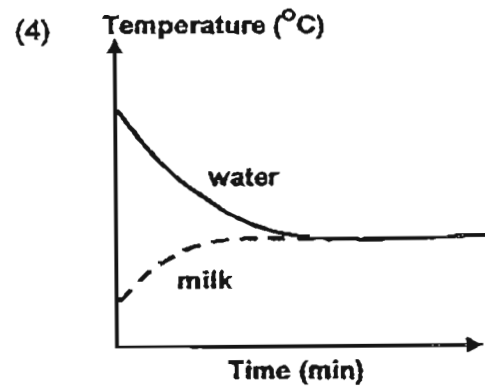
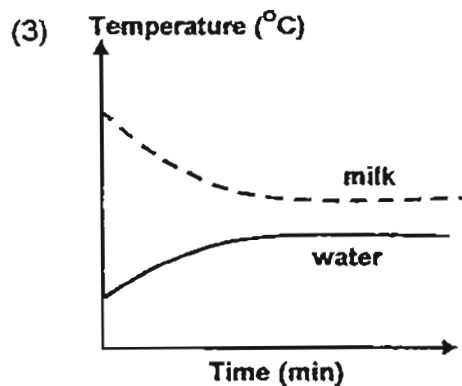
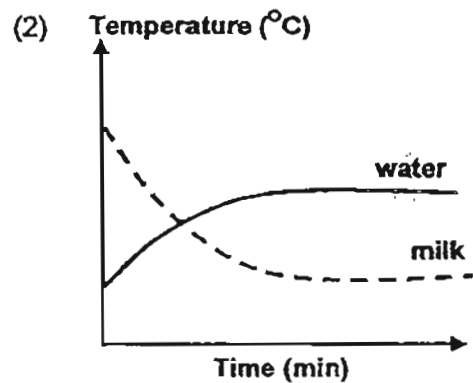
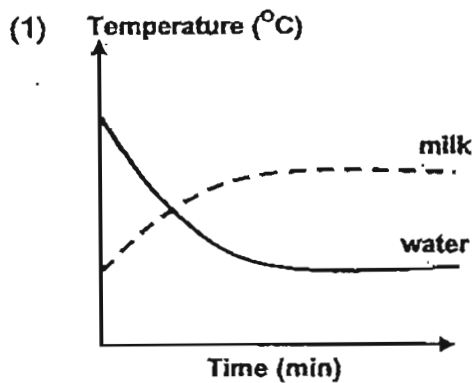
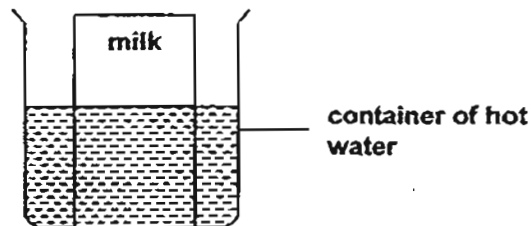

- 18 Which one of the following is not an effect of a force?

- (1) A dented pingpong ball
- (2) A wind sock fluttering in the wind
- (3) An angšana fruit falling from the tree
- (4) A bar of chocolate melting under the Sun

- 19 Russell and his classmates set up the experiment shown below to determine the effectiveness of 4 lubricants, P, Q, R and S.

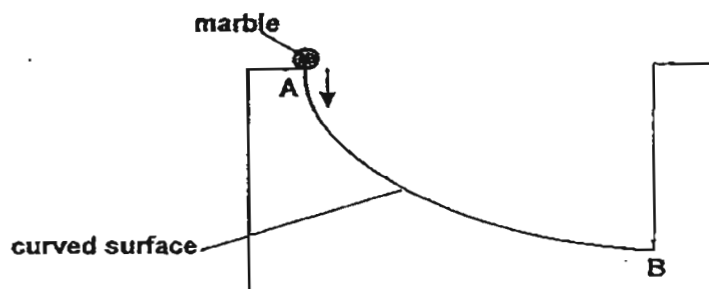

They applied  $10\text{cm}^3$  of lubricant P on the curved surface and a marble was released from point A. They measured the time taken for the marble to move from point A to point B. The apparatus were washed and dried before they repeated the experiment with lubricant Q, R and S. They recorded their observation in the table below.

Lubricant	Time taken (s)
P	3.05
Q	2.43
R	3.28
S	2.86

Based on the above results, which is the most effective lubricant?

- (1) S
- (2) Q
- (3) P
- (4) R

- 20 Study the food chain below carefully.

Plant → Butterfly → Spider → Bird

If the spider population suddenly decreases sharply due to an outbreak of a disease, how would the rest of the populations be affected?

	Plant	Butterfly	Bird
(1)	increase	increase	decrease
(2)	decrease	decrease	decrease
(3)	decrease	increase	decrease
(4)	increase	increase	increase

- 21 Evan learnt that to slow down the rate of decomposition, he needed to make the condition in the environment unsuitable for the decomposers to live in. He placed an equal amount of fresh bread in each of the 4 containers, A, B, C and D, and kept each one of them in different conditions as shown below.

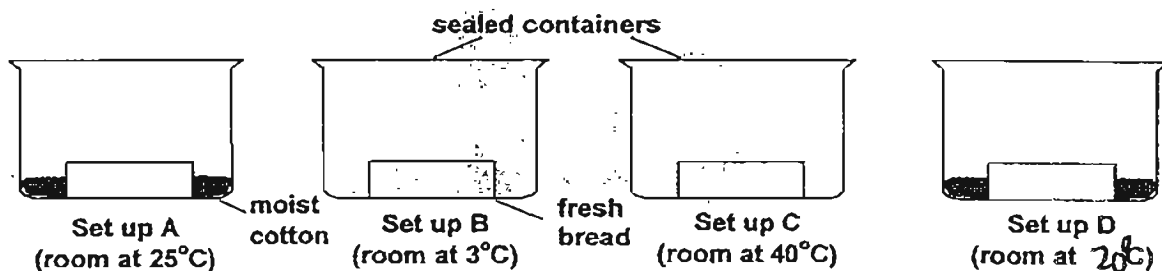

Which container has the best condition to slow down the decomposition of bread?

- (1) A
  - (2) B
  - (3) C
  - (4) D
- 22 The graph below shows how temperature affects the number of 2 types of plants, X and Y.

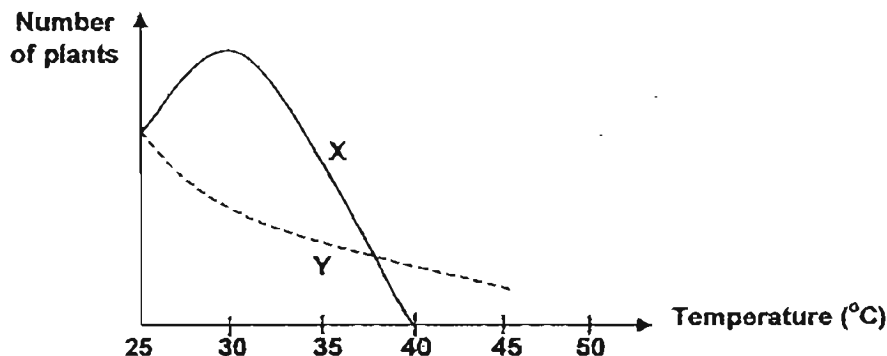

Based on the information given in the graph, 4 pupils made the following conclusions.

**Wei En** : X grows best when at 30°C.

**Ritvik** : The higher the temperature, the fewer Y.

**Alvin** : The higher the temperature, the fewer X.

**Raju** : There are more Y than X between 25°C and 40°C.

Who made the correct conclusion?

- (1) Alvin and Raju only
- (2) Alvin and Ritvik only
- (3) Wei En and Raju only
- (4) Wei En and Ritvik only

23 The bar graph below shows the number of Organisms E, F, G and H living together.

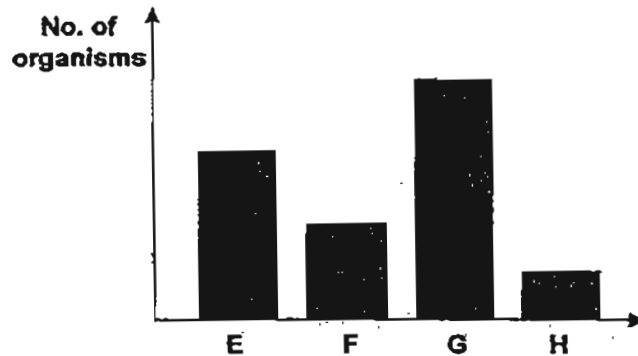

Based on the above data, which one of the following food chains is correct?

- (1) E → F → G → H
- (2) F → H → E → G
- (3) G → E → F → H
- (4) H → F → E → G

24 Isaac drew the following food web based on his observation at a wildlife reserve.

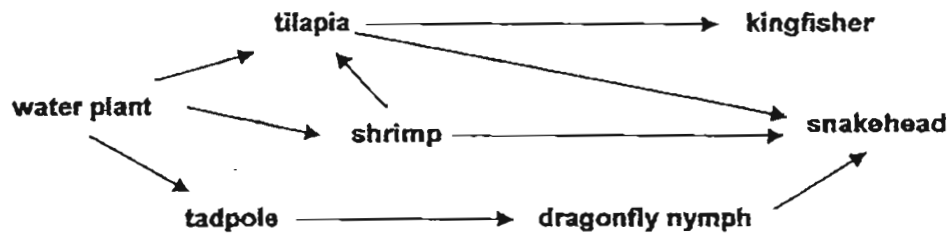

Which of the following statements about the food web are true?

- A Tilapia is the only food source for the kingfisher.
- B All energy from the shrimps is passed to the kingfisher.
- C The shrimp, dragonfly nymph and tilapia are both prey and predator.
- D Only the dragonfly nymph, snakehead and kingfisher are secondary consumers.

- (1) A and B only
- (2) A and D only
- (3) B and C only
- (4) C and D only

25 Darin conducted the experiment as shown below.

Before the stone was released

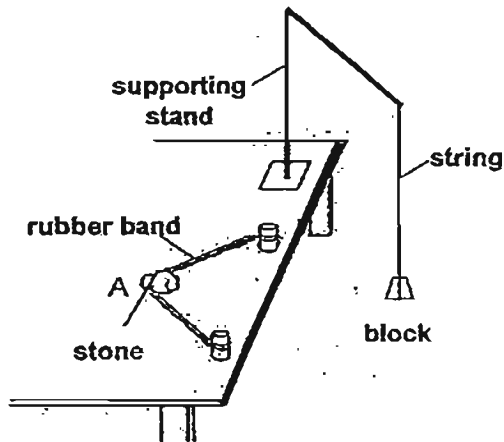

After the stone was released

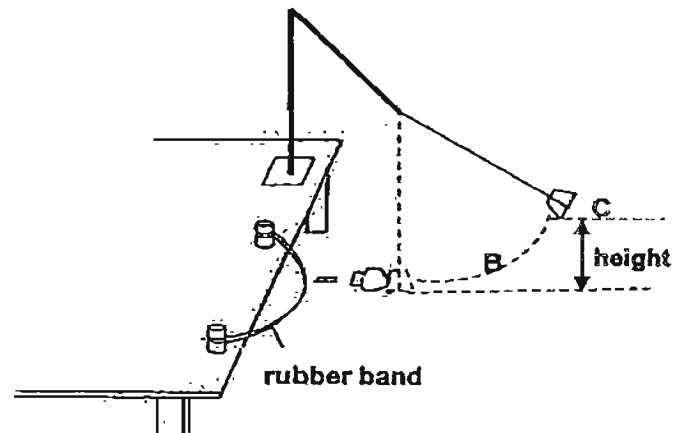

He pulled the rubber band backwards together with a stone to position A. When he released the stone, it moved forward and hit the block which was suspended by a string. The block swung upwards to position B and then position C before falling back.

Which one of the following shows the correct energy transfer from position A?

- (1) Chemical potential energy  $\rightarrow$  Kinetic energy in stone  $\rightarrow$  Kinetic energy in block  
 $\rightarrow$  Heat energy + sound energy
- (2) Elastic potential energy  $\rightarrow$  Kinetic energy in stone  
 $\rightarrow$  Gravitational potential energy in block  
 $\rightarrow$  Heat energy + sound energy
- (3) Elastic potential energy  $\rightarrow$  Kinetic energy in stone  
 $\rightarrow$  Kinetic energy in block + Heat energy + Sound energy  
 $\rightarrow$  Gravitational potential energy in block
- (4) Chemical potential energy  $\rightarrow$  Kinetic energy in stone  
 $\rightarrow$  Gravitational potential energy in block  
 $\rightarrow$  Kinetic energy in block + Heat energy + Sound energy

- 26 The diagram below shows parts of an electrical material separator which is used to separate objects T and U.

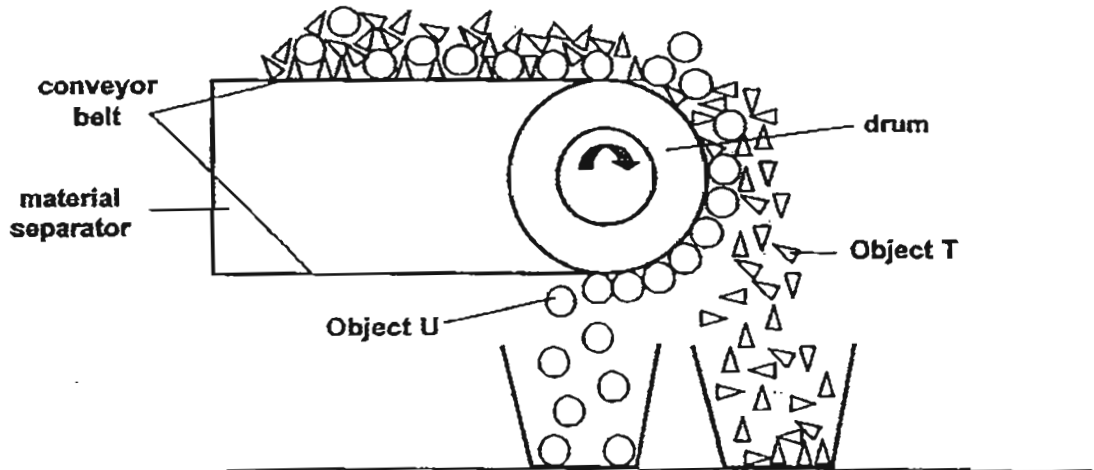

Based on the above diagram, which of the following are true?

- A Only Object U is magnetic.
- B The drum becomes an electromagnet when the switch is turned on.
- C Object T could be made of aluminum while object U is made of copper.

- (1) A and B only
- (2) A and C only
- (3) B and C only
- (4) A, B and C

- 27 When a magnet was brought close to a box with object W, the box moved towards the magnet.

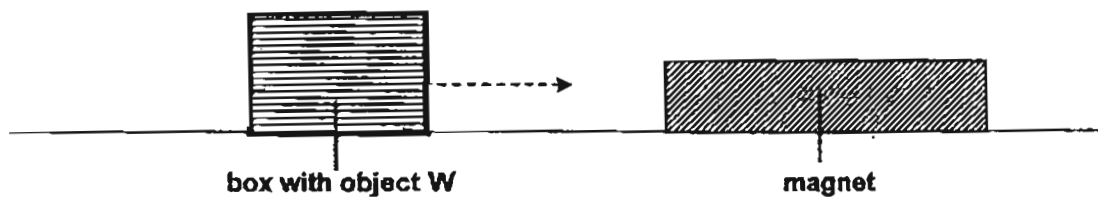

What do you think object W is?

- (1) iron nail
- (2) gold ring
- (3) silver coin
- (4) plastic clip



28 Mangrove plants are adapted to grow in swampy areas.



From the diagram above, what is the function of part X which is above water?

- (1) To take in water for the plant.
- (2) To obtain oxygen from the atmosphere.
- (3) To provide shelter for organisms living in the swamp.
- (4) To act as a support for the mangrove plant in the swamp.

29 Study the following flowchart carefully.

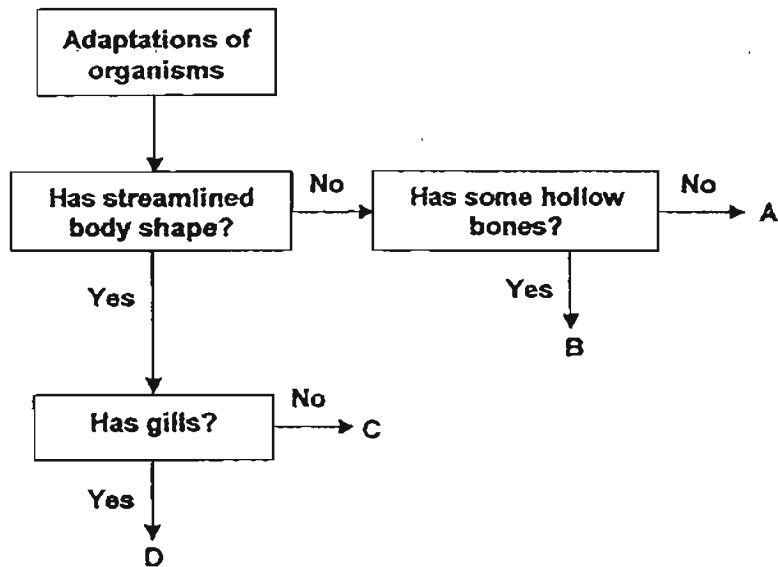

Which of the following best represent A, B, C and D?

	A	B	C	D
(1)	polar bear	ostrich	guppy	penguin
(2)	polar bear	ostrich	penguin	guppy
(3)	ostrich	polar bear	guppy	penguin
(4)	ostrich	polar bear	penguin	guppy

30 The diagram shows 4 objects which are hung from the ceiling.

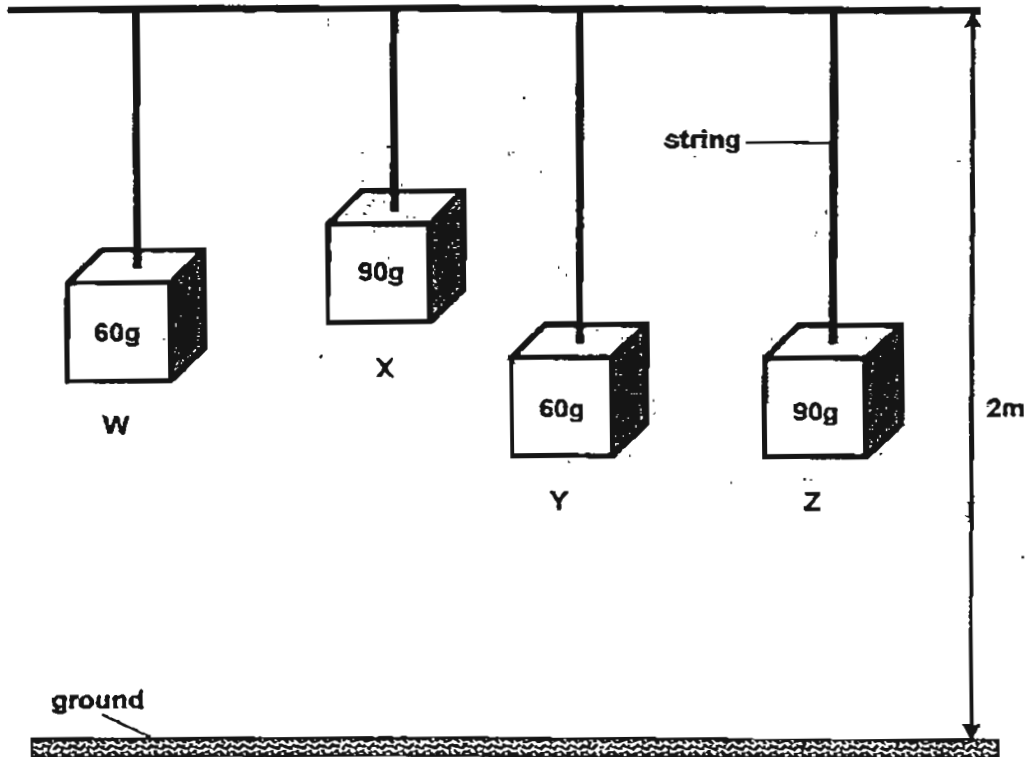

Which of the following statements is/are true?

- A X has more gravitational potential energy than Z.
- B Z has more gravitational potential energy than Y.
- C W and Y have the same amount of gravitational potential energy.
- D When the strings holding object W is cut, all its gravitational potential energy will change into kinetic energy only.

- (1) A and B only
- (2) A and D only
- (3) B and C only
- (4) C and D only

ANGLO-CHINESE SCHOOL  
(JUNIOR)



SEMESTRAL ASSESSMENT 1 (2011)  
PRIMARY 6

SCIENCE

BOOKLET B

Wednesday

11 May 2011

1 hour 45 minutes

Name

Class P6

INSTRUCTIONS TO PUPILS

DO NOT TURN OVER THE PAGES UNTIL YOU ARE TOLD TO DO SO

Follow all instructions carefully.

There are 14 questions in this booklet.

Answer ALL questions.

INFORMATION FOR PUPILS

The number of marks is given in brackets [ ] at the end of each question or part question.

The total marks for this booklet is 40.

The total time for Booklets A and B is 1 hour 45 minutes.

This question paper consists of 16 printed pages (inclusive of cover page).

BOOKLET A	<input type="text"/>	/ 60
BOOKLET B	<input type="text"/>	/ 40
TOTAL	<input type="text"/>	/ 100
Parent's Signature/Date	<input type="text"/>	<input type="text"/>

**Section B (40 marks)**

For questions 31 to 44, write your answers in this book. The number of marks available is shown in brackets at the end of each question or part question.

31. The diagrams represent the life cycles of a mosquito and a grasshopper respectively.

(a) Fill in the boxes with the following words. (You may repeat some of the words)

- Egg
- Adult
- Pupa
- Larva
- Nymph

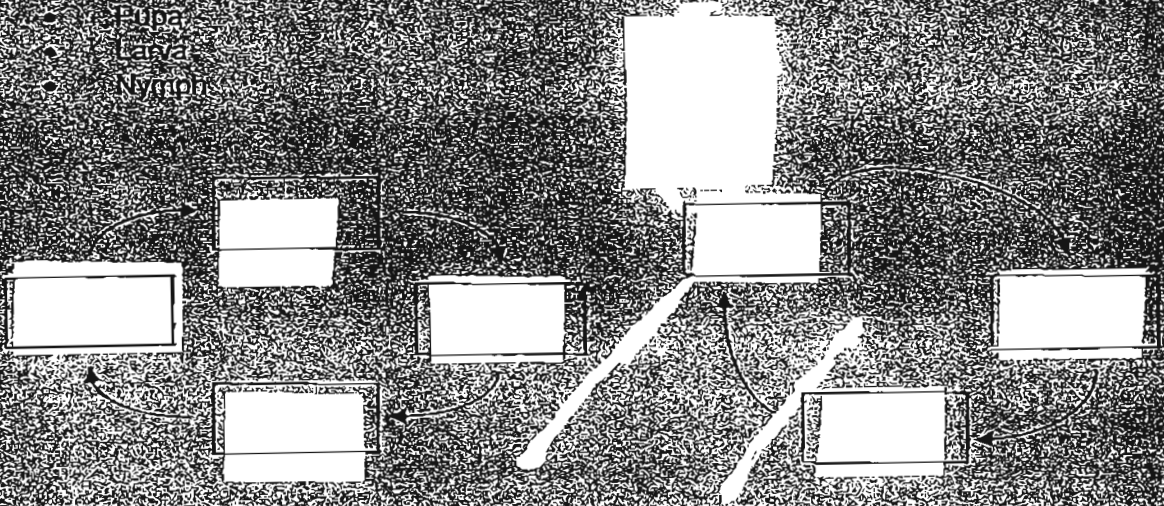

(b) State how the young of the mosquito is different from the young of the grasshopper in terms of movement. [1]

---

---

(c) Why do mosquitoes lay many eggs at a time? [1]

---

---



32 The diagram below shows the female human reproductive system.

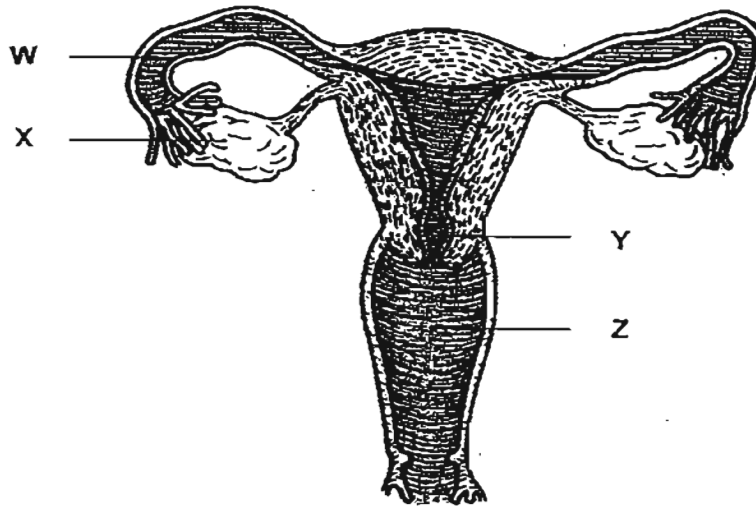

(a) Name parts W, X, Y and Z. [2]

W: \_\_\_\_\_  
X: \_\_\_\_\_  
Y: \_\_\_\_\_  
Z: \_\_\_\_\_

(b) When will a female egg cell be fertilised and develop into a foetus? [1]

\_\_\_\_\_  
\_\_\_\_\_

- 33 Kenny prepared the following set-ups A, B and C, and placed them in the Science Laboratory. 3 similar towels, each had been soaked in 100 ml of water and weighed 200g at the start of the investigation.

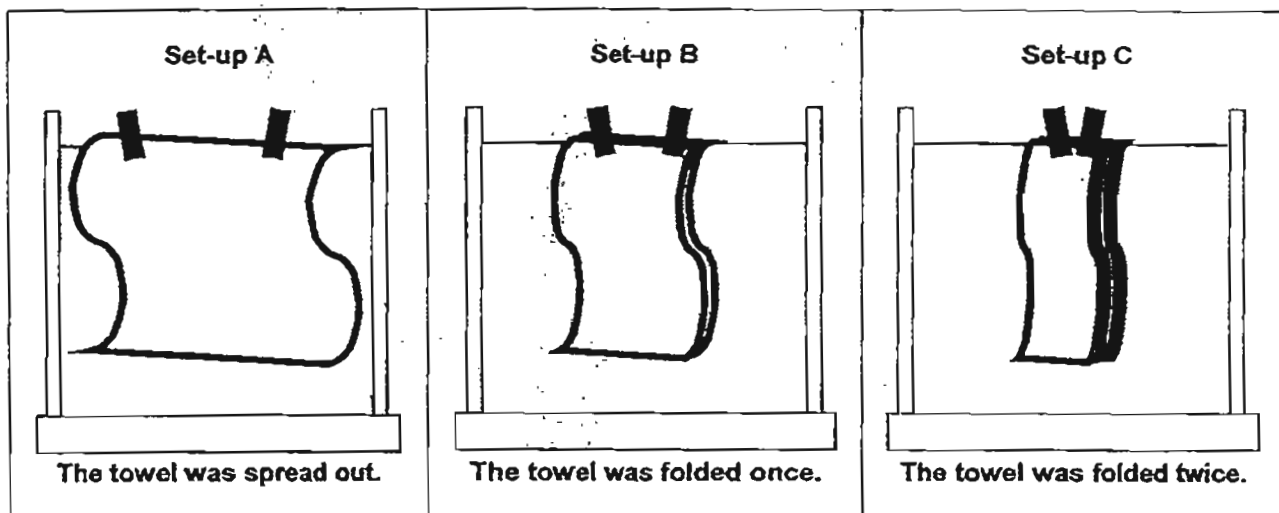

The table below shows the mass of each towel after 5 hours.

Mass of towel after 5 hours (g)		
A	B	C
50	80	200

- (a) Based on the information given in the table above, in which set-up was the rate of evaporation the fastest? [1]

\_\_\_\_\_

- (b) What was the factor that affected the rate of evaporation in this experiment? [1]

\_\_\_\_\_

- (c) From the result of the experiment, which data in the above table is incorrect? Why? [1]

\_\_\_\_\_

\_\_\_\_\_

\_\_\_\_\_

- 34 One bright and sunny afternoon, Mr Brown and his two children set up an experiment by digging a hole in their garden as shown below. They observed that some water was collected in the empty cup after a few hours.

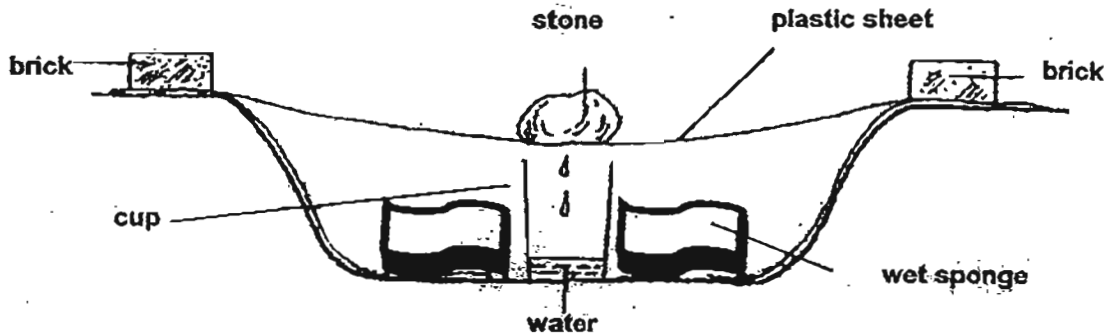

- (a) Explain how the water was formed in the cup. [2]

---

---

---

---

---

---

---

- (b) The above set-up represents the water cycle.

What do the following objects represent in the water cycle? [1]

Wet sponges: \_\_\_\_\_

Plastic sheet: \_\_\_\_\_

--

- 35 Remus used three similar plants, A, B and C, to conduct an experiment. He trimmed off all the leaves from Plant A, and some leaves from Plant C. He then placed each plant in a container of water shown in the diagram below.

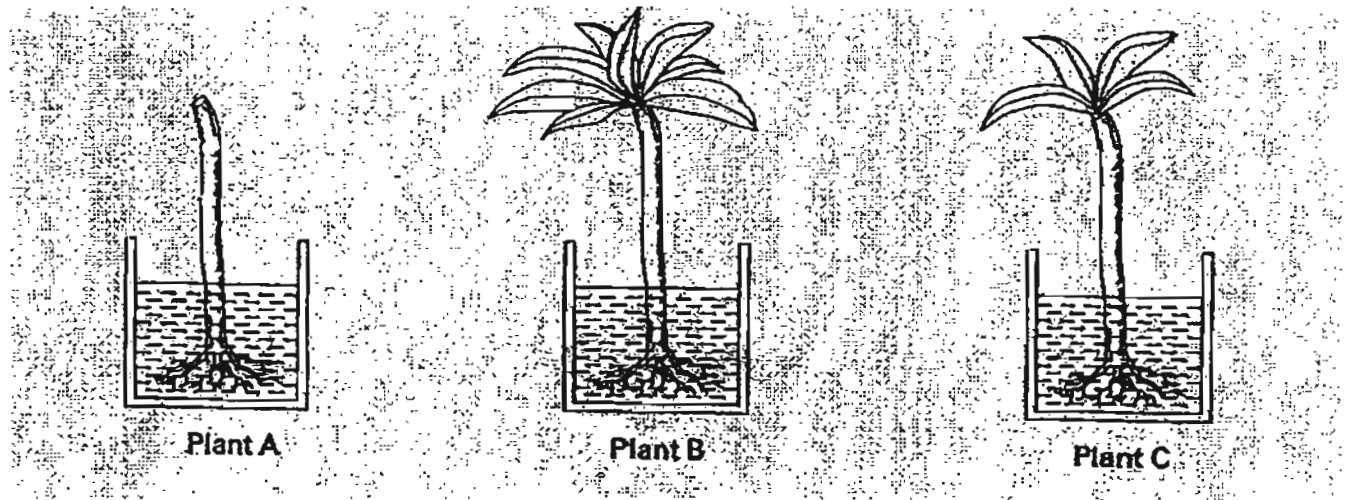

After 2 days, Remus measured the amount of the water in each container. The table below shows the amount of water left in each container.

Amount of water left after 2 days (ml)		
A	B	C
400	320	380

- (a) What was Remus trying to find out through his experiment? [1]

---



---

- (b) What could he have done to all the three set-ups to ensure that the water loss was not due to evaporation? [1]

---



---

- (c) What could he conclude from the results of the experiment? [1]

---



---



36 The diagram shows a balsam plant.

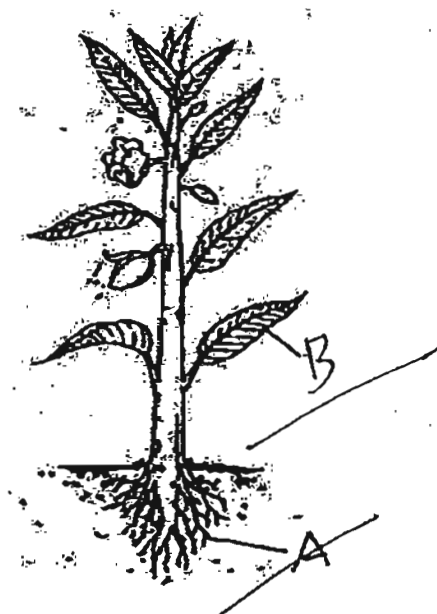

Cell A and Cell B are found in the balsam plant.

The information of two cells, A and B, is recorded in the table below. A tick (✓) shows the presence of the part of the cell.

Parts of cell	Cell A	Cell B
Nucleus	✓	✓
Cell wall	✓	✓
Chloroplast		✓

- (a) **Draw an arrow** pointing to the part of the balsam plant where Cell A is most likely to be found and label it as 'A'. [1]
- (b) **Draw an arrow** pointing to the part of the balsam plant where Cell B is most likely to be found and label it as 'B'. [1]
- (c) Explain your answer in parts (a) and (b). [1]

---



---



---



---

37 Gina made a circuit card as shown below.

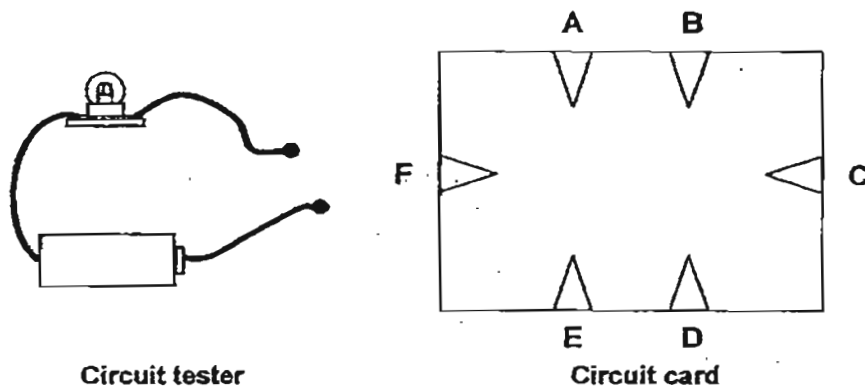

The wires behind the circuit board were arranged as shown below.

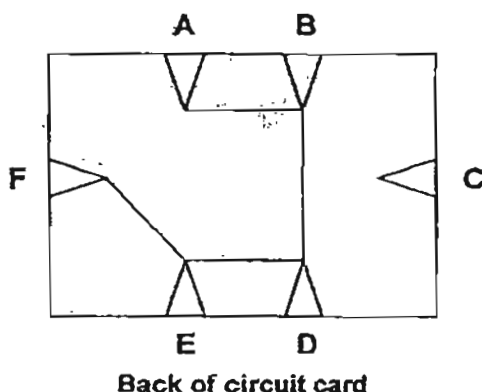

- (a) The table below records the results when the different clips are connected in the circuit card. Based on the circuit card, put a tick (✓) in the box(es) if the light bulb lights up. [1]

Clips connected to circuit tester	Light bulb of circuit tester
A and B	
B and D	
D and F	
D and C	
E and F	

- (b) Gina then replaced the battery in the circuit tester and tested clips A and B again. The bulb lit up very brightly for a short while and then went off. Explain clearly why the bulb only lit up for a short while. [1]

---



---



---

38 Different organisms have different adaptations to increase their chance for survival.

(a) The diagrams below show the nymphs of two organisms, P and Q.



Nymph P

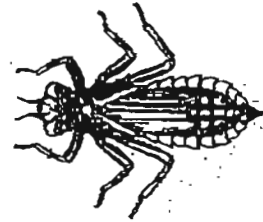

Nymph Q

Which nymph can move through water more easily? Explain your choice.

[1]

---

---

(b) The diagrams below show the glow worm and its habitat in New Zealand's Waitomo cave. There are other flying insects which share the same habitat as the glow worm inside this dark and wet cave. The glow worm produces strands of silk, loaded with thick mucus. It also emits blue light at its tail as it hangs in its hammock of mucus, waiting for its prey.

strands of silk  
loaded with thick  
mucus

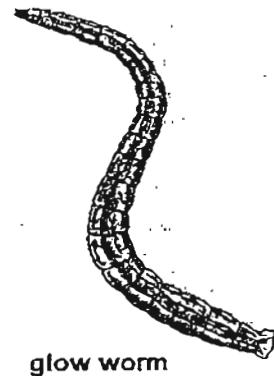

glow worm

Explain how these behavioural adaptations help the glow worm get its food.

[1]

---

---

---

--

- (c) The human digestive system is also adapted to cope with digestion. The diagrams below show part K of the digestive system.

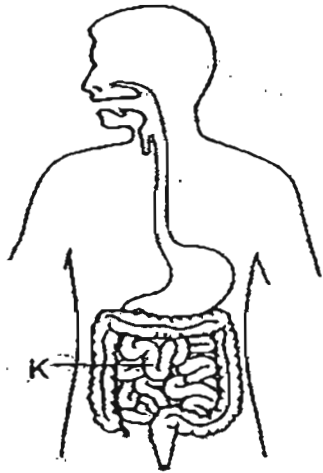

Human digestive system

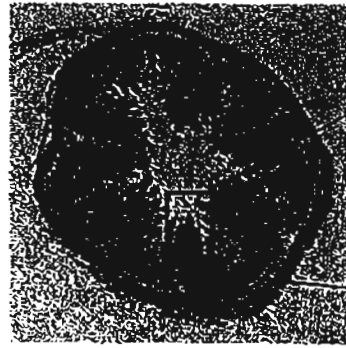

Cross-section of K

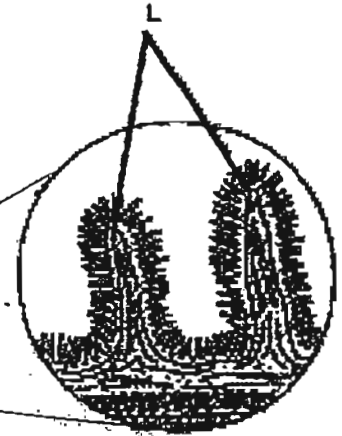

There are numerous tiny structures, L, found in K. Each structure of L has numerous hair-like structures. Explain how these hair-like structures on L help the body to absorb digested food faster. [1]

---

---

- 39 Zachary wanted to find out the effect of detergent on water moss fern. He used 2 similar beakers, R and S, for his experiment. He wanted to set up a control using Beaker S. The apparatus used to set up Beaker R are shown in the diagram and table below.

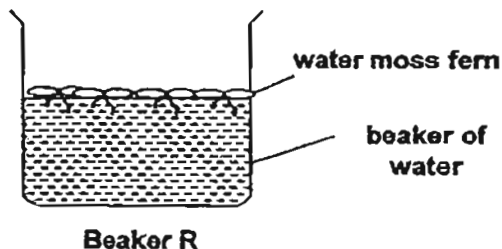

- (a) Complete the table below to show how Zachary should set up Beaker S. [1]

	Volume of detergent used (ml)	Volume of water used (ml)	Number of water moss fern
Beaker R	20	1000	100
Beaker S (control)			

- (b) What observation should he make of both beakers to enable him to compare the effect of detergent on the water moss fern? [1]

---



---

- 40 Zhi Jie observed two animals, G and H, which live in a field. One of them is a herbivore while the other is a carnivore. The population sizes of G and H were counted over time and presented in the graph below.

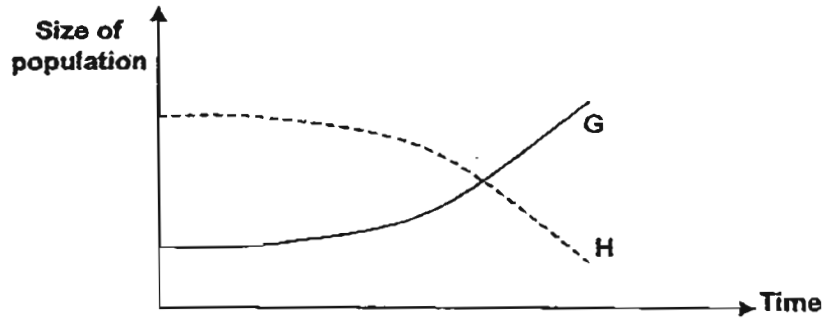

- (a) Write the food chain involving G and H. [1]

---

- (b) What will happen to the population of G if the population of H decreases suddenly? [1]

---

---

- (c) Explain your answer in part (b). [1]

---

---

--

- 41 Matthew conducted an experiment on two springs, P and Q, by hanging different loads on them. The 2 springs measure 5cm long each originally. The graph below records his observation.

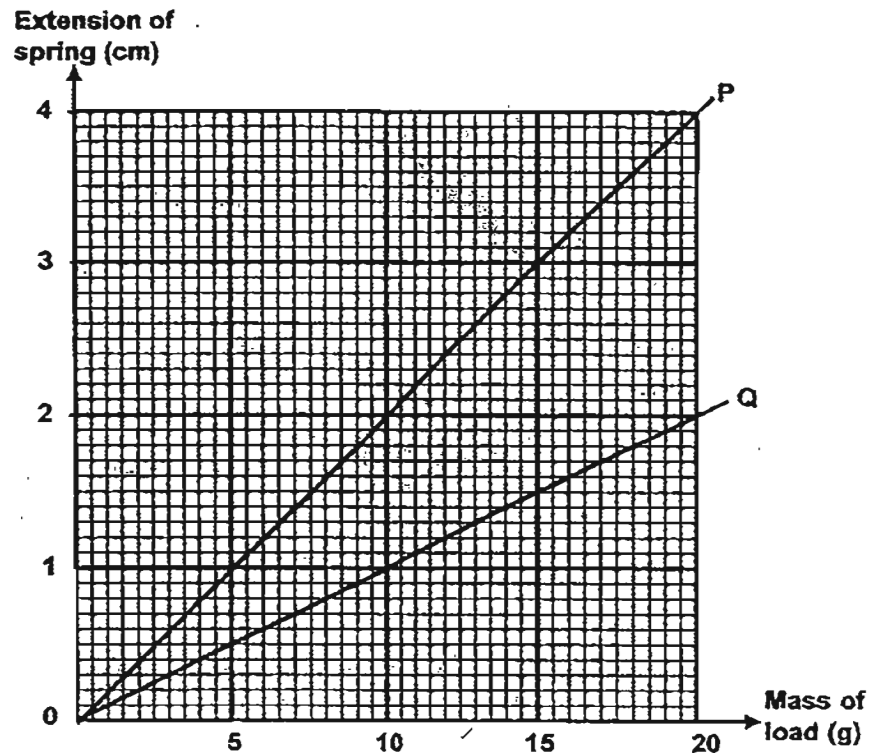

- (a) Using data from the graph, complete the table below. [2]

Spring	Mass of load (g)	Length of spring (cm)
P	10	
Q		6

- (b) Which spring, P or Q, is more elastic? Explain your choice. [1]

---



---

42 Joel wanted to find out if Material J or K is a better conductor of heat. He set up the experiment as shown below at the same corner of a room.

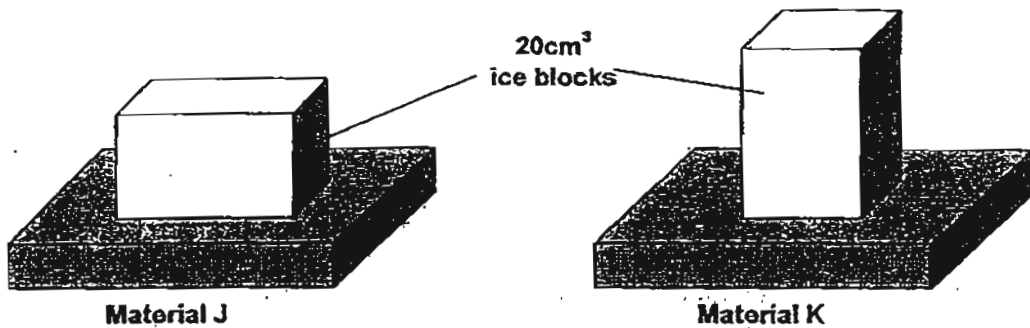

(a) The table below shows the time taken for each ice block resting on the two materials to melt completely.

Ice block resting on Material	Time taken (mins)
J	30
K	10

If Joel wants to use one of the materials to make a container to contain cold drinks for his picnic, which material should he choose? Explain your choice. [1]

---



---

(b) Put a tick (✓) in the correct boxes to indicate if the temperature of the objects used in Joel's experiment increases, decreases or remains the same within the first 5 minutes of the experiment. [1]

Object	Temperature increases	Temperature decreases	Temperature remains the same
Ice block			
Material K			

(c) Is Joel's experiment fair? Explain your answer. [1]

---



---



---

--



43 Daniel wanted to find out if water from different ponds affects the survival of fishes in it.

(a) In the table below, put a tick (✓) against the variables that should be kept constant in his experiment. [1]

Variable				
Type of fish	Number of fish	Type of water	Volume of water	Temperature of water

Daniel next set up 2 similar aquariums, P and Q, as shown below.

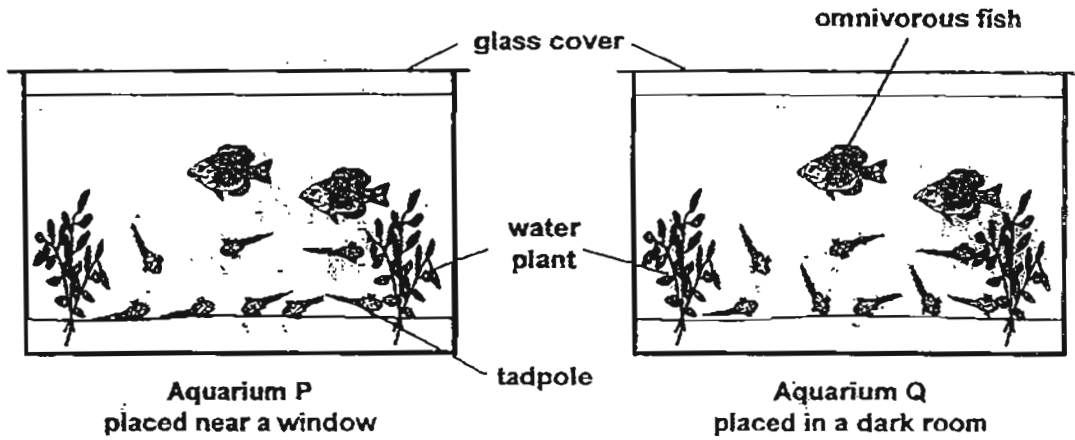

(b) The graph below shows the changes in the number of fish and tadpoles in Aquarium Q after 1 week.

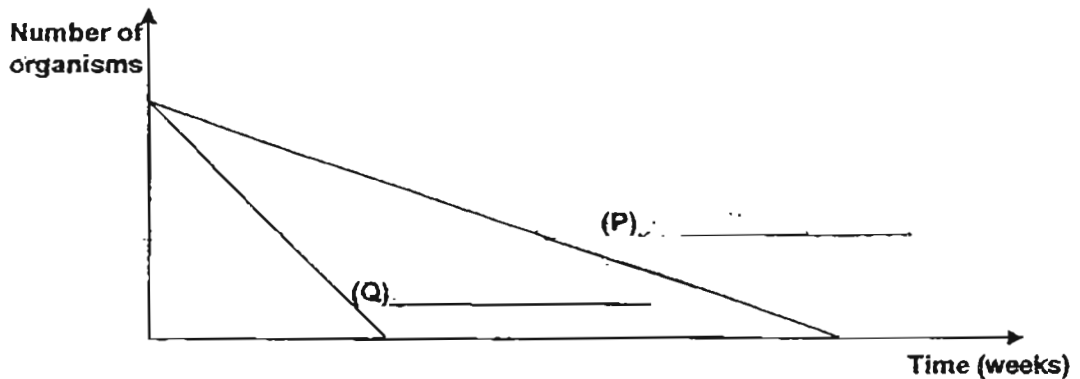

(i) Label the 2 line graphs (P and Q) with 'fish' and 'tadpole' in the blanks provided. [1]

(ii) The organisms in Aquarium P continue to survive. Explain why this is so. [1]

---



---

44 Yifan wanted to compare the speed of running water from four taps by using water wheels. The speed of the running water from each tap is different. He set up the experiment as shown below.

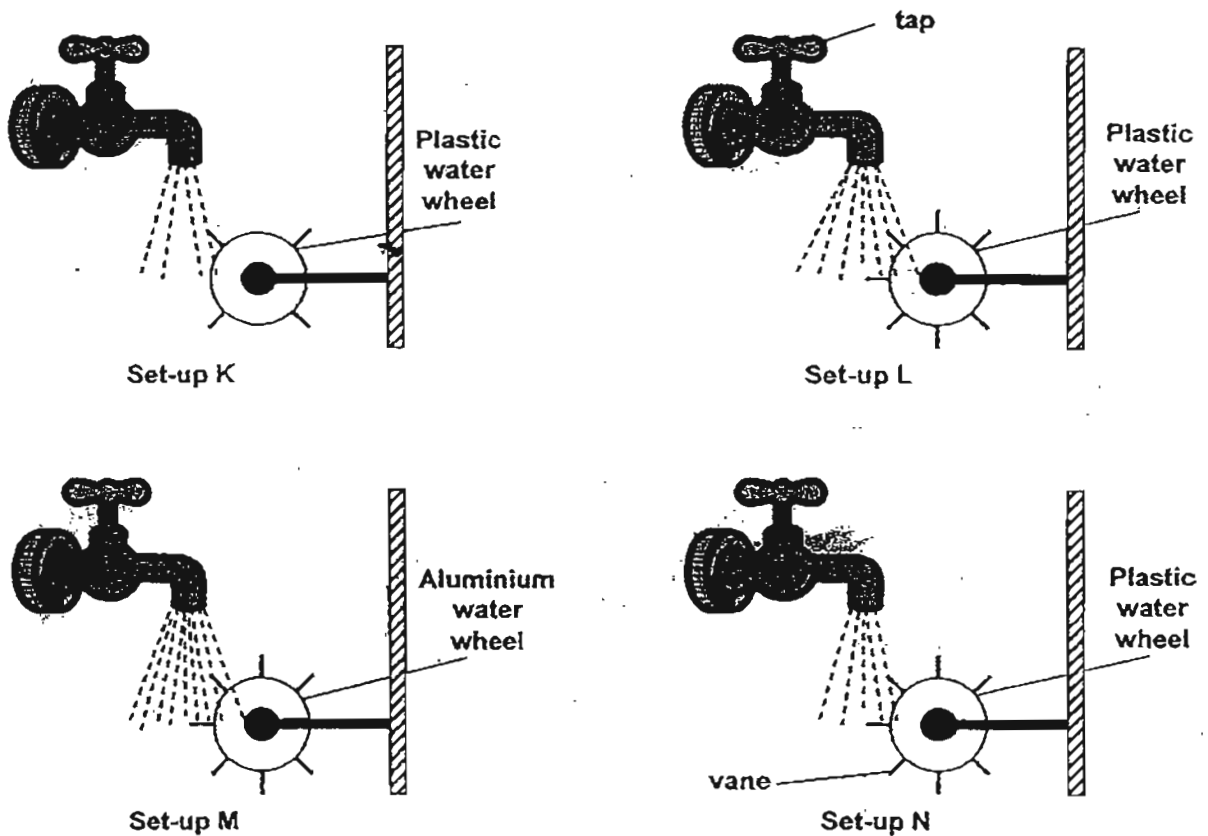

(a) What form(s) of energy does the spinning water wheel possess? [1]

\_\_\_\_\_

(b) Which 2 set-ups can be used to make a fair comparison? Explain your choice. [1]

\_\_\_\_\_

\_\_\_\_\_

(c) Other than your answer in part (b), state 1 other variable which Yifan must keep the same to ensure a fair test. How does keeping this variable constant make the test fair? [1]

\_\_\_\_\_

\_\_\_\_\_

\_\_\_\_\_

--

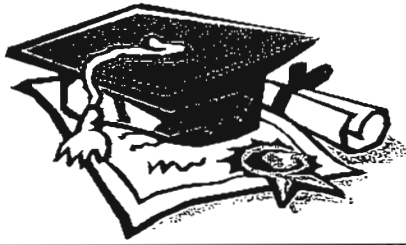

# ANSWER SHEET

**EXAM PAPER 2011**

**SCHOOL : ACS (JUNIOR)  
SUBJECT : PRIMARY 6 SCIENCE**

**TERM : SA1**

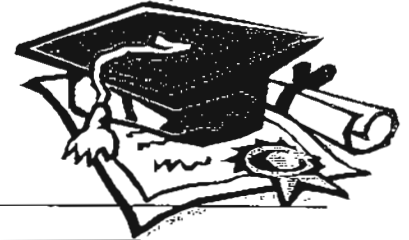

Q1	Q2	Q3	Q4	Q5	Q6	Q7	Q8	Q9	Q10	Q11	Q12	Q13	Q14	Q15	Q16	Q17
4	2	4	3	3	3	1	4	2	4	4	2	3	1	1	4	4

Q18	Q19	Q20	Q21	Q22	Q23	Q24	Q25	Q26	Q27	Q28	Q29	Q30
4	2	3	2	4	3	2	3	1	1	2	2	1

31)a)

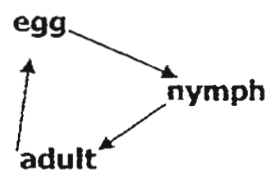
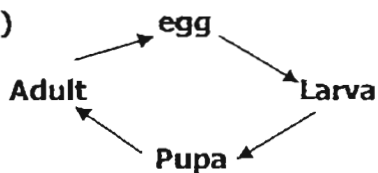

b)The young of the mosquito to wiggles in stagnant water while the young of the grasshopper hops.

c)In case some of the eggs are eaten by predators, there are still others to hatch.

32)a)W: Fallopian tube    X: Ovary    Y: Womb    Z: Vagina

b)When a sperm meets with the egg and fuses with it.

33)a)A.

b)The exposed surface area.

c)C. Even though the towel in set-up C was folded twice, it should still be able to evaporate some water and would weight less than 200g.

34)a)Since it was bright and sunny, the water from the wet sponge evaporate and condensed on the interior of the plastic sheet. As the stone is right above the cup the water would collect below the stone and full into the cup.

b)Water bodies. / clouds

35)a)He was trying to find out if the number of leaves on the plant would affect the amount of water it absorbs.

b)Pour in some oil into each set-up.

c)The grater the number of leaves the greater amount of water it absorbs.

36)a)b)

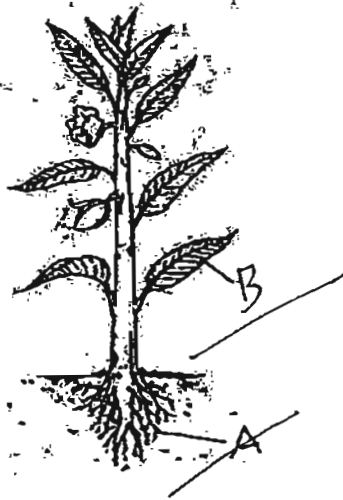

c)As cell A has no chloroplast, it does not photosynthesize which means it is the root hair cell while cell B has chloroplast which means it photosynthesizes and is a leaf cell.

37)a)A and B, B and D, D and F, E and F

b)The battery was so strong that the bulb fused after too much electricity was flowing through it.

38)a)P. It has a streamlined body to move through water more easily.

b)The blue light attracts flying insects which will fly into the silk strand and get stuck.

c)The hair-like structures increase the exposed surface area which digests food faster.

39)a)0, 1000, 100

b)He should count the number of water moss fern left in each beaker after a fixed period of time.

40)a)Plant → H → G

b)It will also decrease.

c)As H is the food source for G, if H decreases, there will be less food for G and they will eventually die.

41)a)P → 7    Q → 10

b)P. With the same mass of load, P stretches more than Q.

42)a)J. It took a longer time for the ice cube in J to melt, so it is the better insulator of heat and can contain cold drinks for a picnic.

b)Ice block → Temperature remains the same.    Material K → Temperature decreases

c)No. The surface area of the ice blocks in contact with Material J and K is not the same.

43)a) 

✓	✓		✓	✓
---	---	--	---	---

b)i) P → fish    Q → tadpole

ii) As it is placed near the window, it has sunlight for the plants to photosynthesize and produce oxygen for the fish to survive.

44)a) Kinetic energy and Sound energy.

b) N and L. All the Variables in both set-up are the same except for the speed of running water.

c) A smaller water wheel will turn faster than a bigger water wheel.