

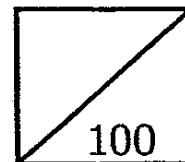

**Rosyth School**  
**Preliminary Examination for 2006**  
**SCIENCE**  
**Primary 6EM1/2**



Name: \_\_\_\_\_ Total Marks: \_\_\_\_\_

Class: Pr \_\_\_\_\_ Register No. \_\_\_\_\_ Duration: 1 h 45 min

Date: 23.8.06 Parent's Signature: \_\_\_\_\_

Instructions to Pupils:

1. Do not open the booklets until you are told to do so.
2. Follow all instructions carefully.
3. This paper consists of 2 booklets, Booklet A and Booklet B.
4. For questions 1 to 30 in Booklet A, shade the correct ovals on the Optical Answer Sheet (OAS) provided using a 2B pencil.
5. For questions 31 to 46, give your answers in the spaces given in the Booklet B.

	<b>Maximum</b>	<b>Marks Obtained</b>
<b>Booklet A</b>	<b>60 marks</b>	
<b>Booklet B</b>	<b>40 marks</b>	
<b>Total</b>	<b>100 marks</b>	

\* This booklet consists of  21  pages .

This paper is not to be reproduced in part or whole without the permission of the Principal.

**Part I (60 marks)**

For each question from 1 to 30, four options are given. One of them is the correct answer. Make your choice (1, 2, 3 or 4). **Shade the correct oval (1, 2, 3 and 4) on the Optical Answer Sheet.**

1. Anderson observed some animals. He recorded his observations in the table as shown below.

Observation	Spider	Butterfly	Cockroach	Earthworm
It has feelers.	No	Yes	Yes	Yes
It has 6 legs or more.	No	Yes	Yes	No
Its body has segments.	No	No	Yes	Yes

Which one of the following animals is correctly described?

- (1) Spider
  - (2) Butterfly
  - (3) Cockroach
  - (4) Earthworm
2. Three containers K, L and M were made of different materials. They were filled with equal amount of boiling water. The time taken for the water in each container to cool down was plotted on the graph as shown below.

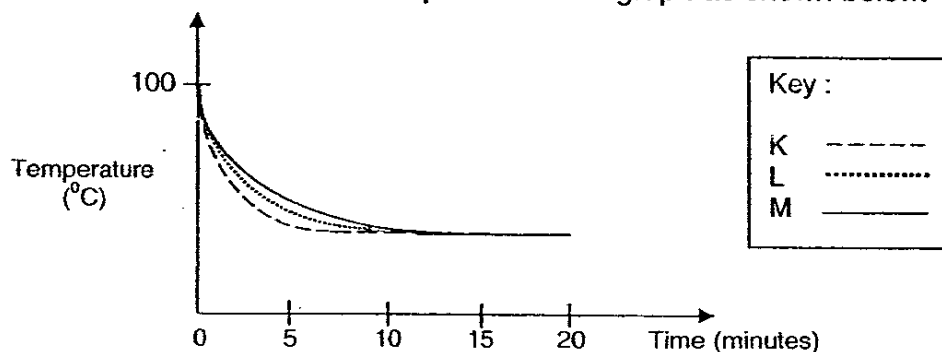

Based on the above graph, identify the possible material of each container.

	Container K	Container L	Container M
(1)	Plastic	Iron	Wood
(2)	Wood	Plastic	Iron
(3)	Glass	Styrofoam	Aluminium
(4)	Aluminium	Glass	Styrofoam

( Go on to the next page)

3. Study the diagram of an onion bulb shown below carefully.

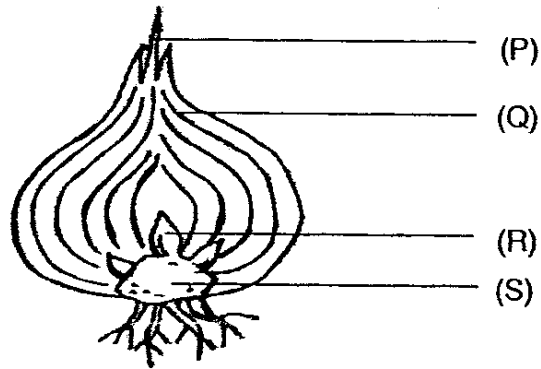

Which one of the labelled parts provides the young plant with food?

- (1) P
  - (2) Q
  - (3) R
  - (4) S
4. The diagram below shows the process of cell division.

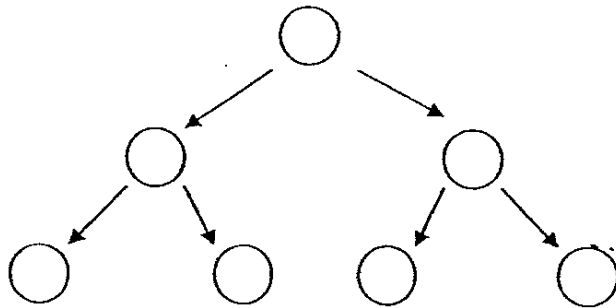

At the 4<sup>th</sup> generation, how many cells would there be?

- (1) 8
- (2) 16
- (3) 32
- (4) 64

(Go on to the next page

5 Study the classification chart shown below.

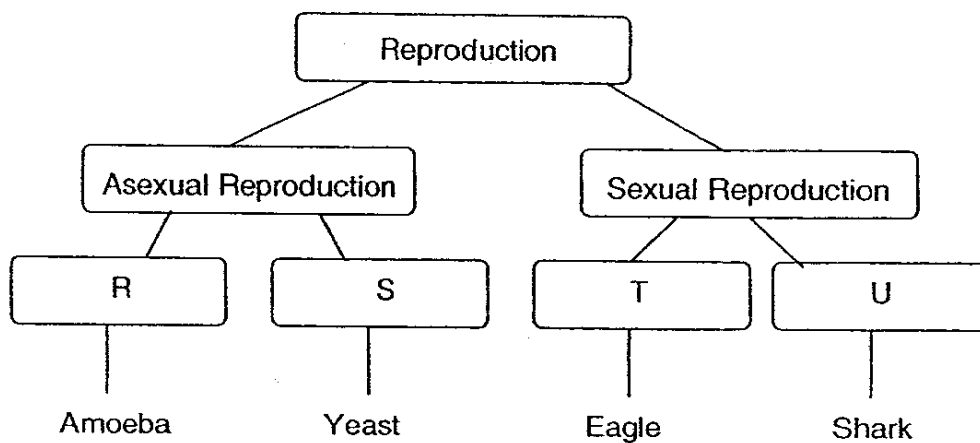

Identify the headings for R, S, T and U.

	R	S	T	U
(1)	Budding	Binary fission	Giving birth	Laying eggs
(2)	Budding	Binary fission	Laying eggs	Giving birth
(3)	Binary fission	Budding	Laying eggs	Giving birth
(4)	Binary fission	Budding	Giving birth	Laying eggs

6. The picture below shows a cross section of a flower.

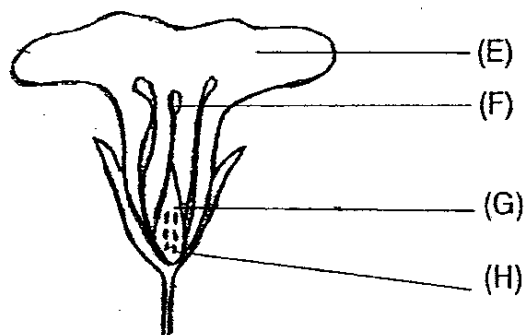

Which one of the labelled parts will develop into a fruit?

- (1) E
- (2) F
- (3) G
- (4) H

(Go on to the next page)

7. Study the diagrams of the cactus and water hyacinth shown below carefully.

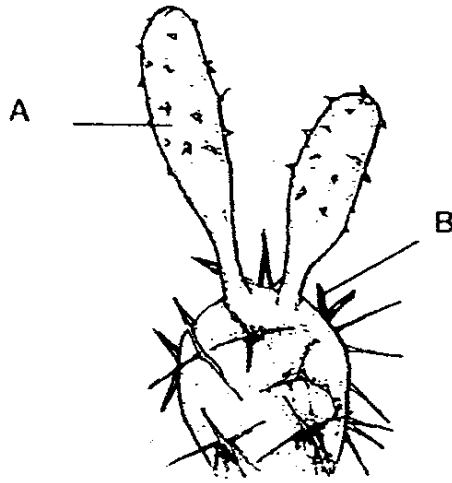

Cactus

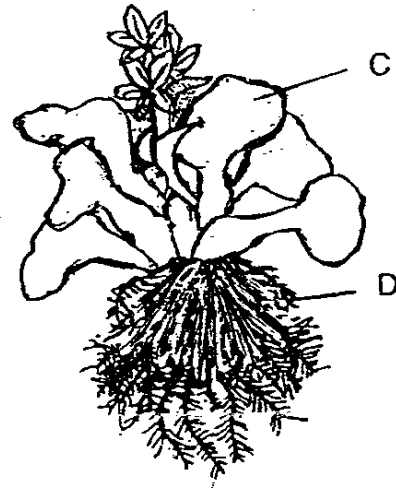

Water hyacinth

Which of the following parts of the two plants have the same main function?

- (1) A and C only
- (2) A and D only
- (3) B and C only
- (4) B and D only

(Go on to the next page)

8. The graph below shows the percentage of carbon dioxide in the air surrounding a plant measured over 24 hours.

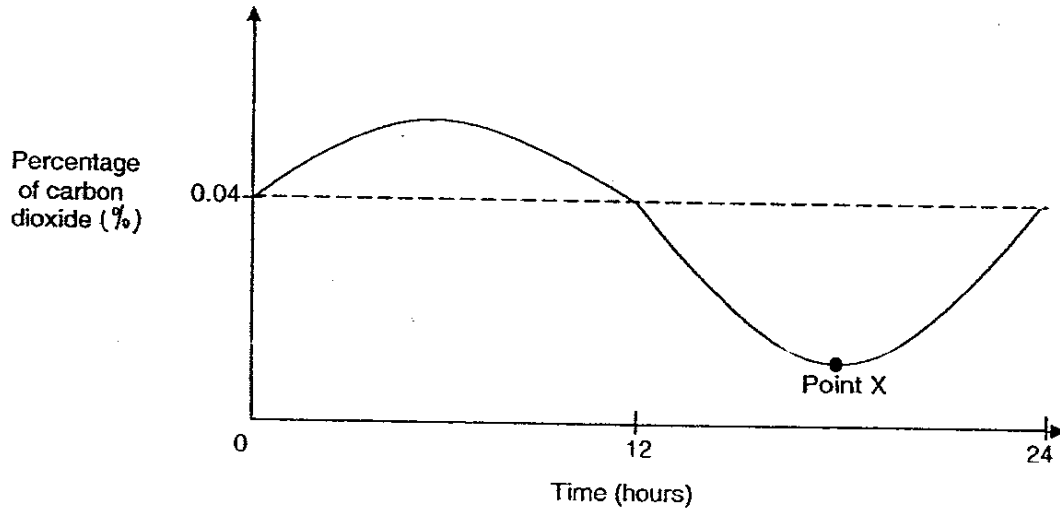

Which of the following sets of information explains the percentage of carbon dioxide at Point X?

	Time of the day	Process taking place
(1)	Night	Respiration
(2)	Night	Transpiration
(3)	Day	Photosynthesis
(4)	Day	Respiration

(Go on to the next page)

9. **Milton solution helps to kill all microorganisms in set-ups X and Y.**

The diagram below shows an experiment to find out about respiration carried out by germinating seeds. The same number of germinating seeds and dead seeds were left into set-ups X and Y respectively. All the seeds were placed in Milton solution during the experiment.

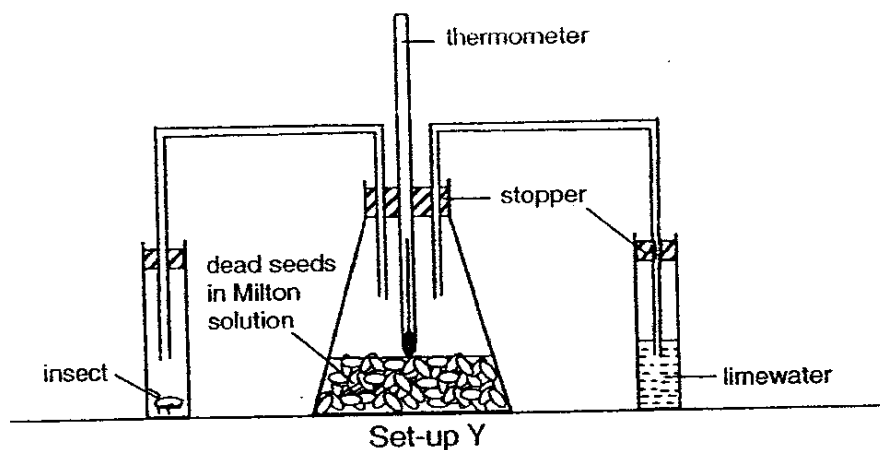
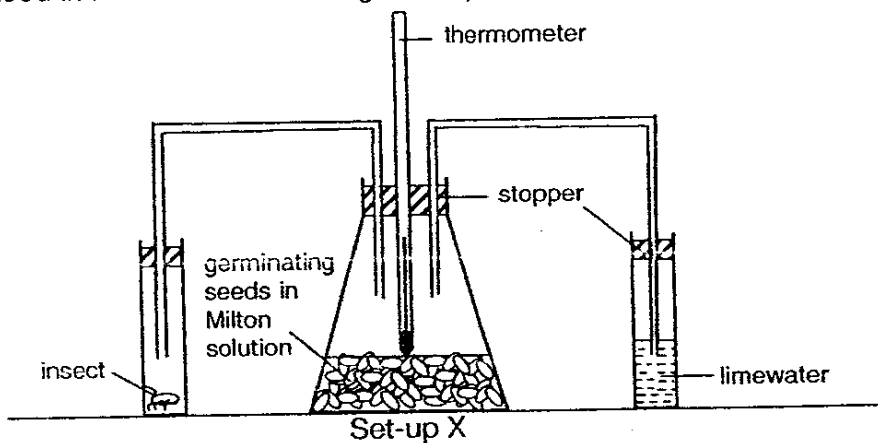

Which of the following changes were most likely observed at the end of the experiment?

- A: The insect lived longer in set-up Y than in set-up X.
- B: The temperature was higher in set-up X than in set-up Y.
- C: The limewater in set-up X was less chalky than in set-up Y.
- D: More water droplets were formed in the set-up Y than in set-up X.

- (1) A and B only
- (2) B and C only
- (3) C and D only
- (4) A, B, C and D

(Go on to the next page)

10. The diagram below shows the muscles of a human arm.

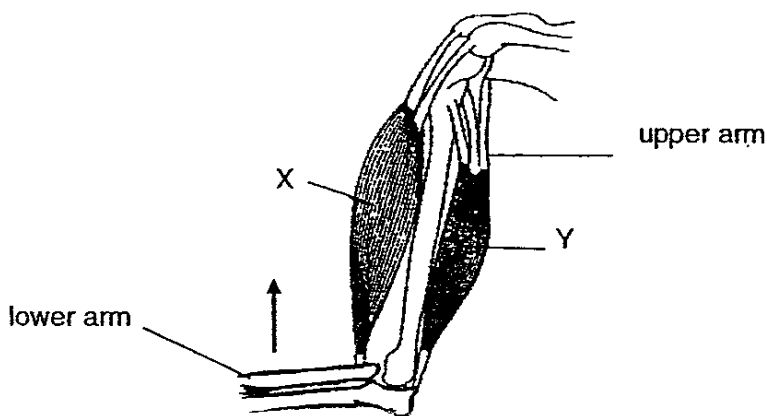

When the lower arm is raised in the direction shown above, what happens to muscles X and Y?

	Muscle X	Muscle Y
(1)	Contracts	Contracts
(2)	Contracts	Relaxes
(3)	Relaxes	Contracts
(4)	Relaxes	Relaxes

11. The diagram below shows an air sac in the human lung.

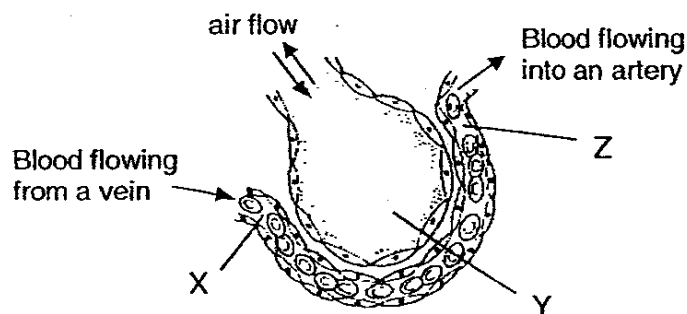

Which one of the following sets of information correctly describes the amount of oxygen at X, Y and Z?

	X	Y	Z
(1)	High	Low	High
(2)	High	Low	Low
(3)	Low	High	High
(4)	Low	High	Low

(Go on to the next page)



12. A plant was placed in a bell jar under the light as shown below. Due to the reaction between substance X and carbon dioxide that are present in air in the bell jar, the food made by the plant had substance X in it after a few hours.

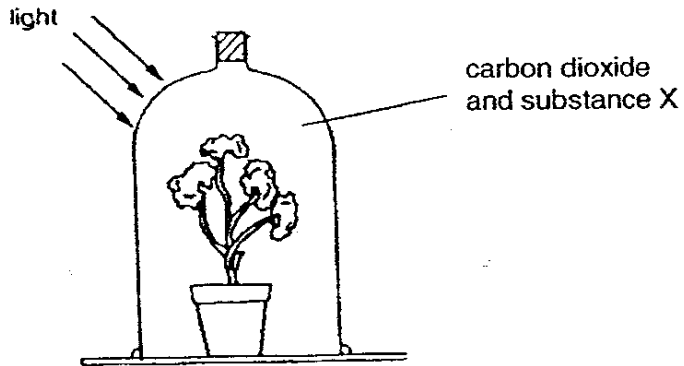

When thin slices were cut from the stem of the plant and placed on a photographic film, the parts that had food containing substance X became black.

Which one of the following diagrams shows the areas that had turned black correctly?

(1)

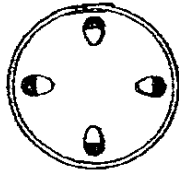

(2)

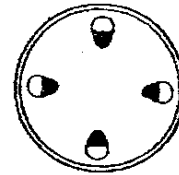

(3)

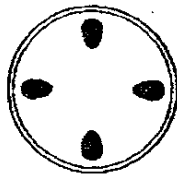

(4)

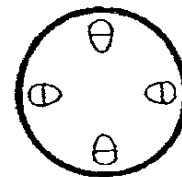

(Go on to the next page)

13. Mary measured the population of producers, the population of consumers, and the amount of dissolved mineral salts in a pond over a period of two years. The results were represented in a graph as shown below.

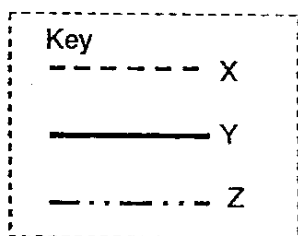
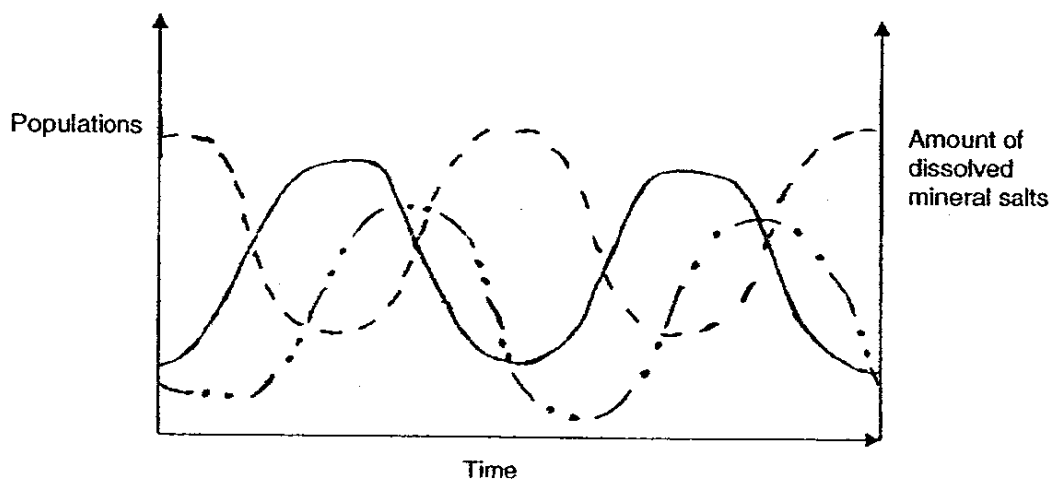

Which of the following shows the correct representations for the population of producers, the population of consumers and the amount of dissolved mineral salts in the pond?

	Producer population	Consumer population	Amount of dissolved mineral salts
(1)	Y	X	Z
(2)	Z	X	Y
(3)	X	Y	Z
(4)	Y	Z	X

(Go on to the next page)

14. Study the classification chart below.

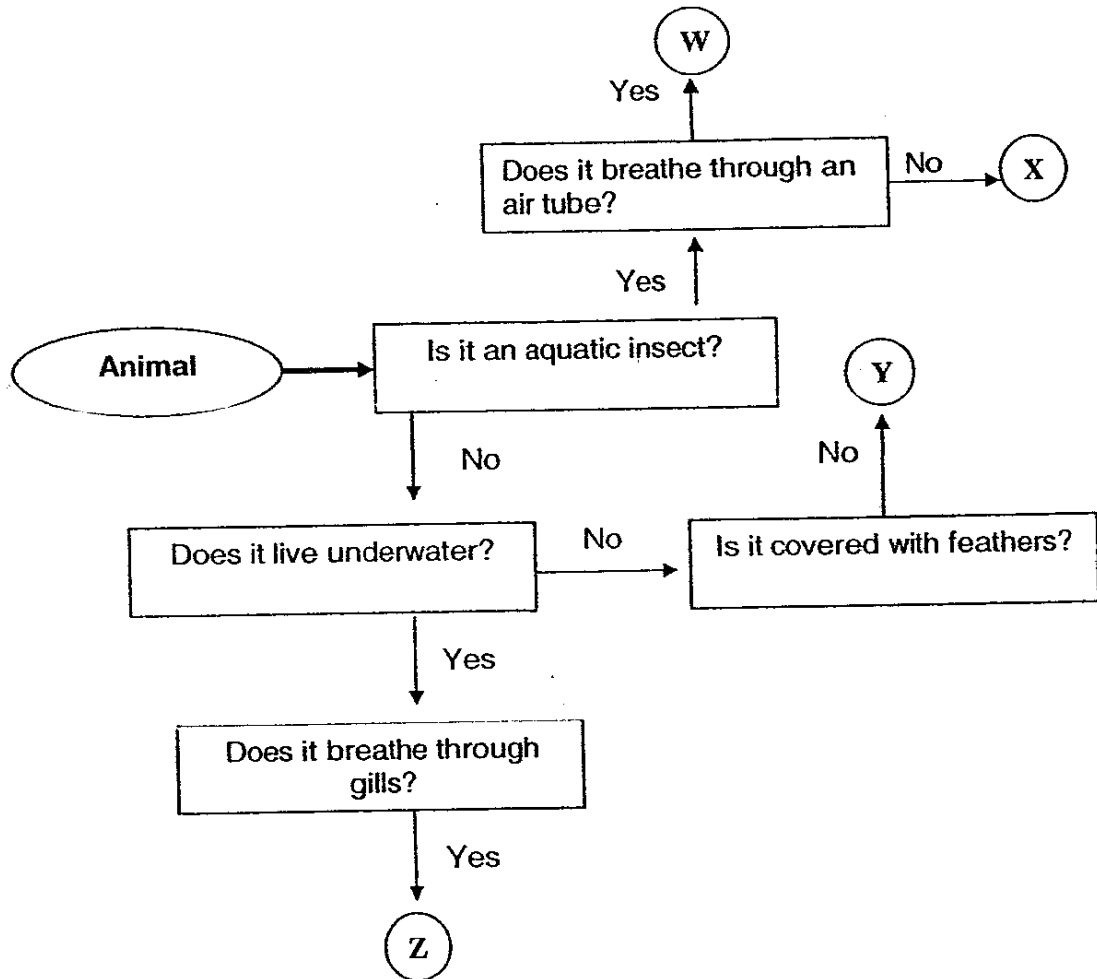

Which of the following deductions about the organisms are most likely to be true?

- A: W is an organism which may be found mostly in the bottom of a pond. .
- B: X is an organism which may carry a bubble of air on its body.
- C: Y is an organism which may have blowholes.
- D: Z is an organism which may have fins.

- (1) A and B only
- (2) A and D only
- (3) B and C only
- (4) B and D only

(Go on to the next page)

15. Farmer Tan wanted his potatoes to be big and yellow. He decided to produce his potato by genetic selection. He selected plant M which had big and white potatoes and plant N which had small and yellow potatoes. He bred the two plants, M and N, several times to produce new parent plants over the years.

Which of the following characteristics of potatoes could be produced from the new parent plants?

- A: Big and yellow
- B: Big and white
- C: Small and yellow
- D: Small and white

- (1) A and C only
- (2) B and D only
- (3) A, B and C only
- (4) A, B, C and D

16. The table below shows the characteristics of four different habitats P, Q, R and S found in an environment.

Characteristics of the habitat	Habitat			
	<del>P</del>	<del>Q</del>	R	S
Temperature	Fluctuates widely	Fluctuates widely	Some changes	Little or no change
Presence of moisture	Dry	A little damp	Very wet	Damp
Sunlight	Bright	Bright	Partially shady	Dark
Air/Ventilation	Airy	Airy	Some ventilation	Stale

David found an organism in one of the habitats. He observed and recorded the characteristics of the organism as shown below.

It is sensitive to light.  
 It feeds on dead matter.  
 It uses gills for exchange of gases.

In which one of the habitats was the above organism most likely to be found?

- (1) P
- (2) Q
- ~~(3) R~~
- (4) S

(Go on to the next page)

17. How are penguins adapted to stay underwater for a long period of time?

- A: They have flippers.
- B: They have webbed feet.
- C: Their feathers are thick.
- D: Their muscles are able to store large amounts of oxygen.

- (1) A only
- (2) D only
- (3) B and D only
- (4) A , B and C only

18. Paul conducted an experiment. He placed a chair at a distance from him. He threw a deflated balloon at the chair and observed that it remained stationary. Next, he inflated the balloon before throwing it at the chair again. This time, the chair fell backwards in the direction as shown in the diagram below.

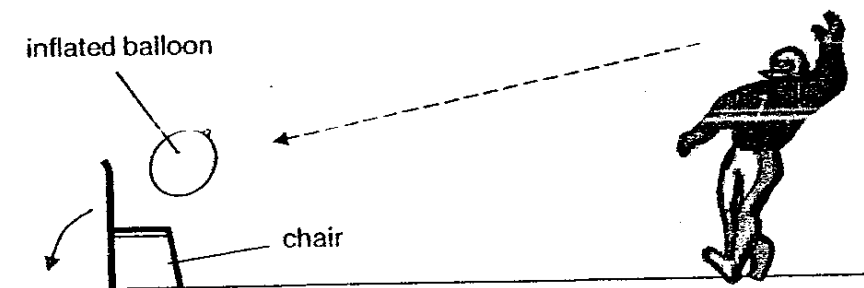

Which of the following conclusions can he make from his observations in the experiment?

- A: Air has volume.
- B: Air can be compressed.
- C: Air has exerted a force on the chair.

- (1) C only
- (2) A and B only
- (3) B and C only
- (4) A, B and C

(Go on to the next page)

19. Mike conducted an experiment using the setups below to find out about objects A and B. When he placed a weight in the tray in setup A, the piston moved downwards. He continued to add more weights until the piston could no longer move. He did the same to setup B.

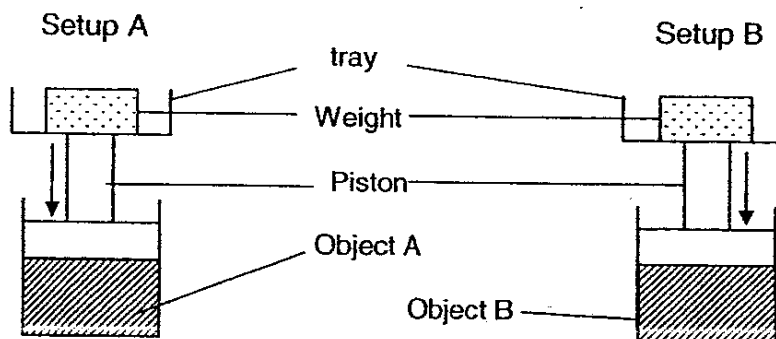

What measurements should <sup>Mike</sup> ~~Paul~~ take in order to compare the compressibility of objects A and B in his experiment?

- (1) Number of weights
- (2) Mass of the objects
- (3) Shape of the objects
- (4) Thickness of the objects

20. Study the water cycle shown below carefully,

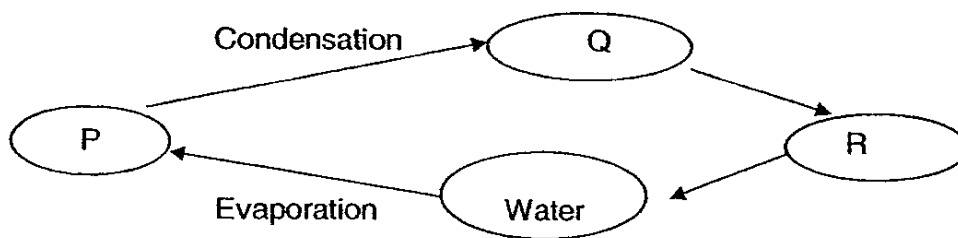

What do P, Q and R in the water cycle above represent?

	P	Q	R
(1)	Rain	Clouds	Water vapour
(2)	Clouds	Rain	Water vapour
(3)	Water vapour	Clouds	Rain
(4)	Water vapour	Rain	Clouds

(Go on to the next page)

21. Tom wanted to find out how the wires behind the circuit card shown below were connected. He joined the two ends of a circuit tester to the different points of the card each time.

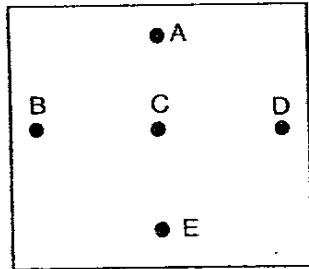

Circuit card

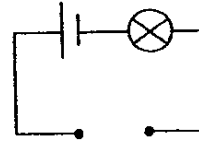

Circuit tester

The results of the Tom's test were recorded in the table below.

Points joined to circuit tester	Did the bulb light up?
A and B	No
A and E	Yes
B and D	No
C and E	Yes

Based on the table, which one of the following shows the correct arrangement of the wires behind the circuit card?

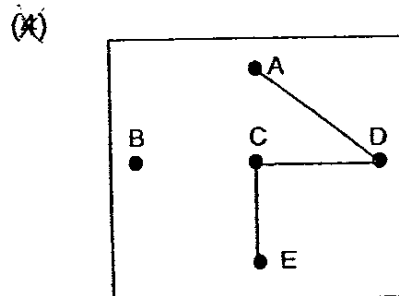
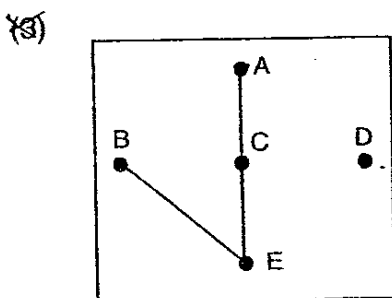
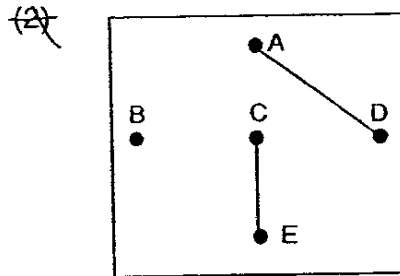
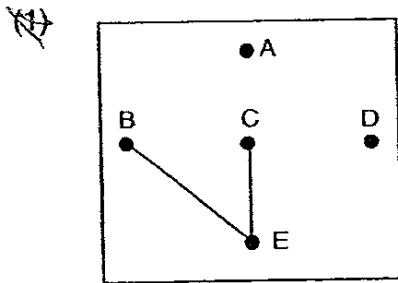

(Go on to the next page)

22. Study the diagram of an electric circuit shown below.

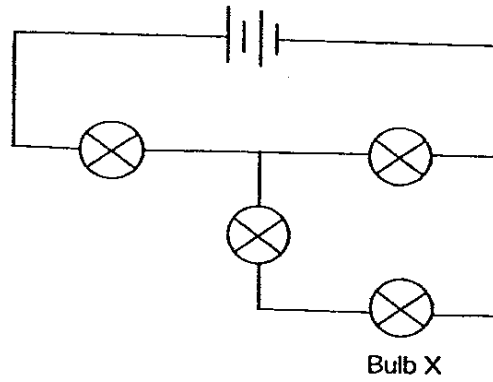

If Bulb X fuses, how many bulbs will remain lighted?

- (1) 1
- (2) 2
- (3) 3
- (4) 0

(Go on to the next page)



23. Jamie conducted an experiment to find out how the position of the object affected the image in a pinhole camera. She made a tiny hole in the middle of one side of the box and ~~placed~~ a screen was placed at the opposite end of the box.

When she placed the object at Point X, the image was formed on the screen as shown below.

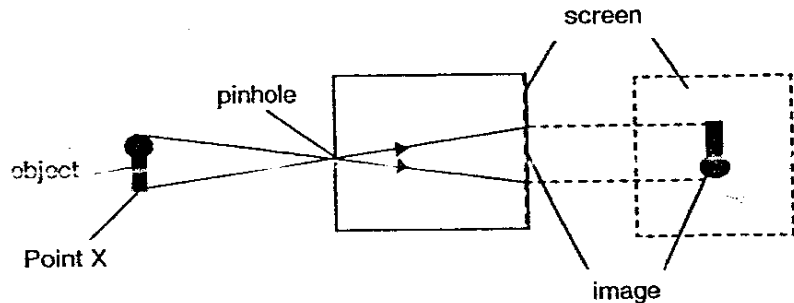

When the object was placed at Point Y, the image was formed as shown below.

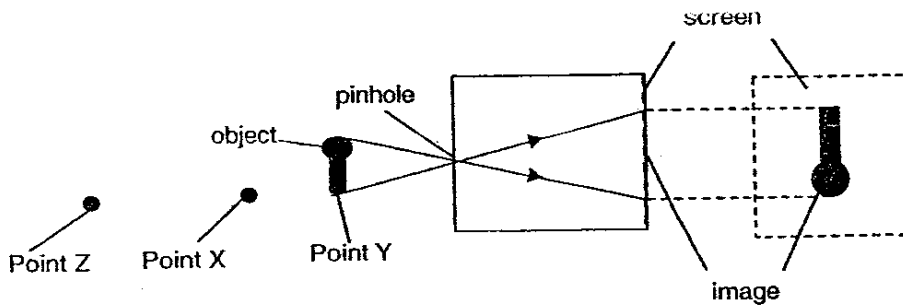

When the object was placed at Point Z, which of the following would likely be observed about the image formed on the screen?

- A: The image would be upright.
  - B: The image would be inverted.
  - C: The image would be bigger than the object.
  - D: The image would be smaller than the object.
- (1) A and B only  
(2) A and C only  
(3) B and C only  
(4) B and D only

(Go on to the next page)

24. The table below shows the boiling points and melting points of 4 different substances P, Q, R and S.

Substance	Boiling point (°C)	Melting point (°C)
P	24	-5
Q	70	15
R	105	23
S	178	50

Which of the substances (P, Q, R and S) are in the liquid state at room temperature?

- (1) P and S only  
 (2) Q and R only  
 (3) P, Q and R only  
 (4) P, Q, R and S
25. A fair test was conducted to compare the amount of light and heat emitted by two bulbs, X and Y of the same voltage. Each bulb was tested in an electric circuit to measure the amount of light and heat given out. The same amount of electricity was supplied in both circuits. The graph below shows the amount of light and heat emitted by Bulbs, X and Y.

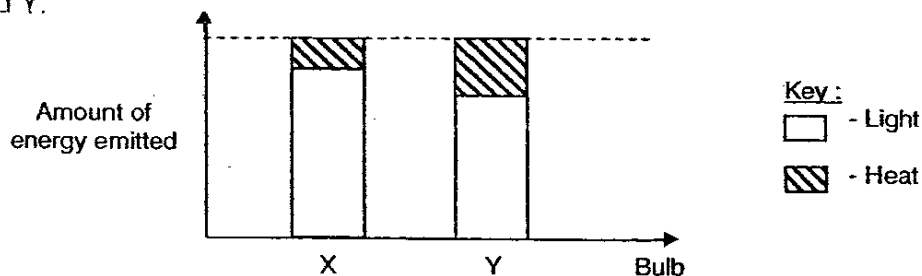

Based on the graph, which of the following deductions are definitely true about Bulbs X and Y?

- A: Bulb Y is able to last longer than Bulb X.  
 B: Bulb X is able to conserve more energy than Bulb Y.  
 C: Bulb Y is brighter than Bulb X when more electricity is supplied.  
 D: Bulb Y is hotter than Bulb X when the same amount of electricity is supplied.
- (1) A and B only  
 (2) A and C only  
 (3) B and C only  
 (4) B and D only
- (Go on to the next page)

26. The graph below shows the changes in the length of a spring when various weights are attached to it.

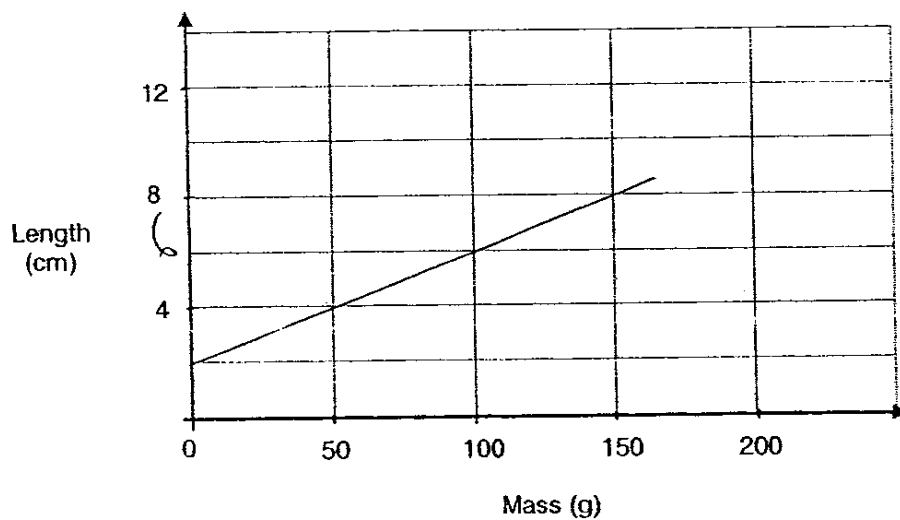

From the graph, what will be the extension of the spring when a 200g of weight is attached to the spring?

- (1) 6 cm
- (2) 8 cm
- (3) 10 cm
- (4) 12 cm

(Go on to the next page)

27. Magnets must be stored properly so that they do not lose their magnetic strength. Sally wanted to find out the best way to store magnets. She stored four similar magnets of equal strength, A, B, C and D, with other magnets of similar strength in four different ways (W, X, Y and Z) as shown below.

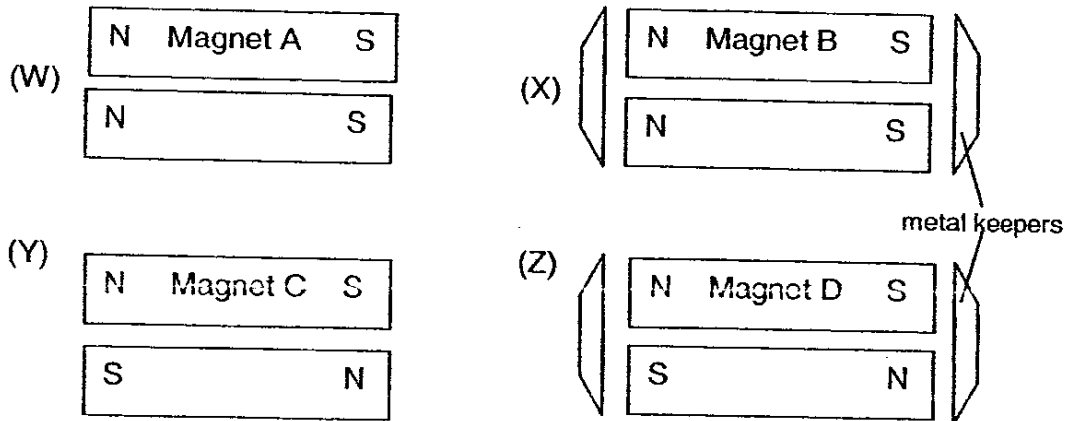

After a few days, she suspended the four magnets, A, B, C and D, to determine the strength of the magnets. She observed the number of pins attracted to the magnets from the plastic tray as shown below.

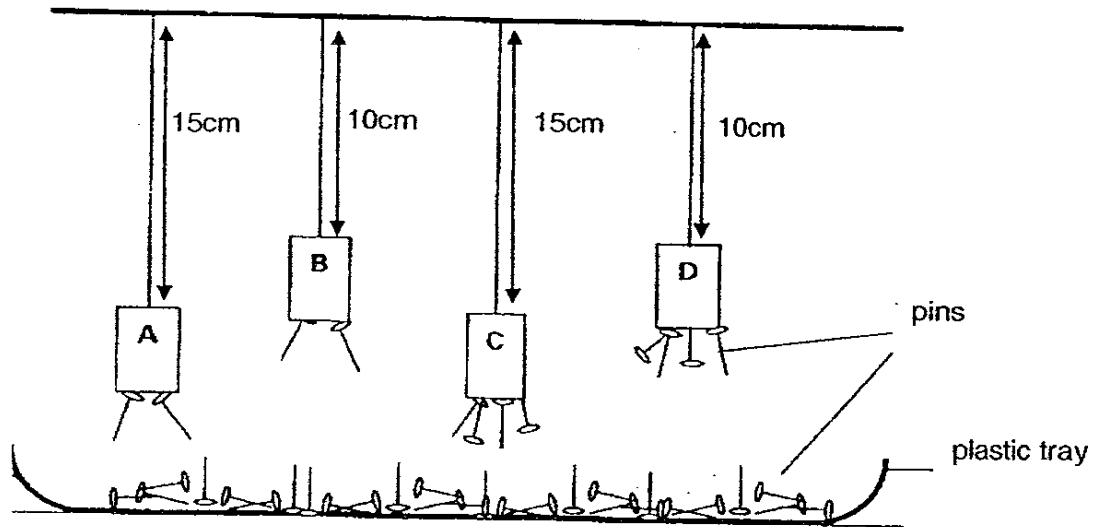

Based on her observation made, which is the best way to store magnets?

- (1) W
- (2) X
- (3) Y
- (4) Z

(Go on to the next page)

28. Siew Lan screwed four metal rings into a door, as shown below. She could open the door by putting a hook into one of the rings, (E, F, G or H) and pulling.

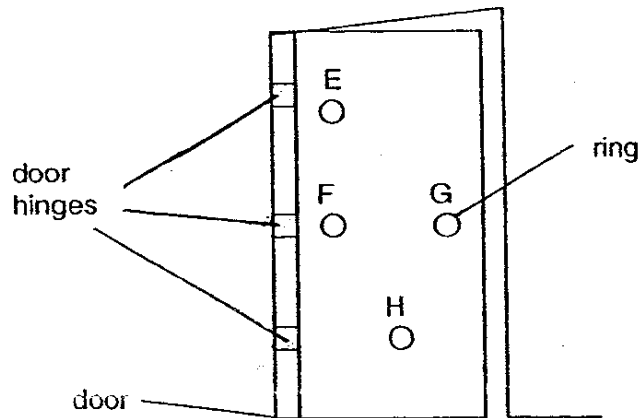

She wanted to find out if the distance between the fulcrum and effort would affect the force needed to pull the door. Which two rings should she use for a fair test?

- (1) E and F
  - (2) F and G
  - (3) G and H
  - (4) H and E
29. Arvin had four wheel and axles, (P, Q, R and S) as shown below.

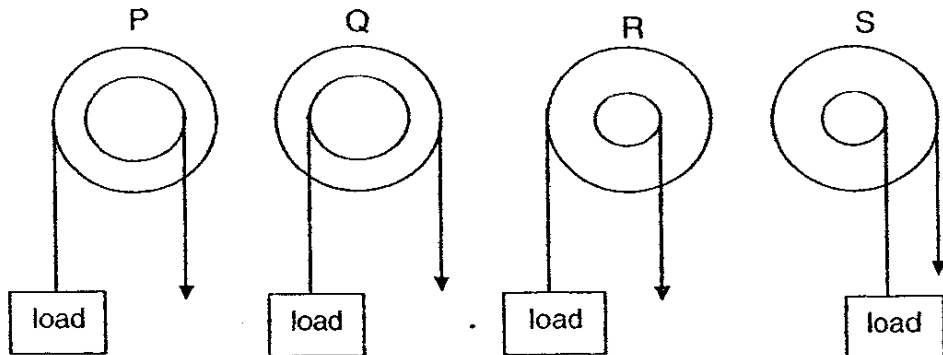

His teacher asked him to choose a wheel and axle, (P, Q, R or S) which will enable him to use less force and also to change the direction of force. Which one of the wheel and axles should he choose?

- (1) P
- (2) Q
- (3) R
- (4) S

(Go on to the next page)

30. David used two ramps, X and Y, to raise an identical load up to the same height. He observed that the effort needed for ramp X was greater than the effort needed for ramp Y.

What possible conclusions can he made about the two ramps, X and Y?

- A: Ramp X is steeper than ramp Y.
  - B: Ramp Y is shorter than ramp X.
  - C: The distance moved by the load using ramp X is greater than the distance moved by the load using ramp Y.
  - D: The distance moved by the effort using ramp Y is greater than the distance moved by the effort using ramp X.
- (1) A and C only
  - (2) A and D only
  - (3) B and C only
  - (4) B and D only

**End of Booklet A**



**Rosyth School**  
**Preliminary Examination for 2006**  
**SCIENCE**  
**Primary 6EM1/2**

Total  
Marks:

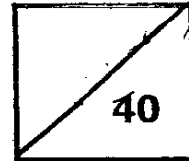

Name: \_\_\_\_\_

Class: Pr \_\_\_\_\_ Register No. \_\_\_\_\_ Duration: 1 h 45 min

Date: 23.8.06 Parent's Signature: \_\_\_\_\_

---

## **Booklet B**

Instructions to Pupils:

1. For questions 31 to 46, give your answers in the spaces given in this Booklet B.

\* This booklet consists of 14 pages.

This paper is not to be reproduced in part or whole without the permission of the Principal.

**Part II (40 marks)**

Write your answers for questions 31 to 46 in the spaces provided.

31. The diagram below shows the life cycle of the mosquito.

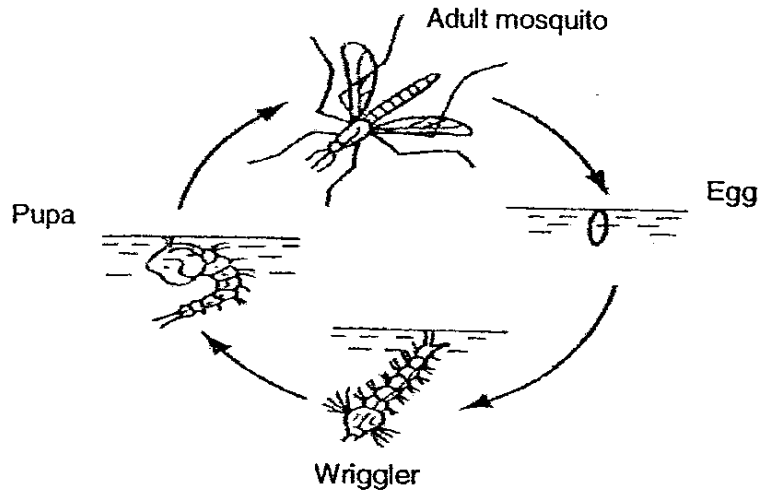

(a) At which stage of the life cycle is the mosquito most harmful to man? [1]  
Explain why.

---

---

(b) Suggest a way in which the population of mosquito can be reduced drastically. [1]

---

---

(Go on to the next page)



32. Study the diagram of a plant cell shown below.

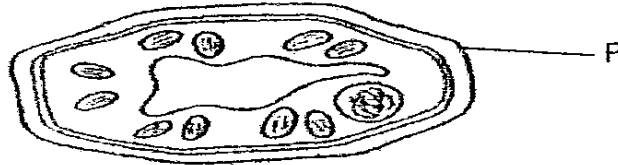

(a) What will happen to the cell if part P is removed? [1]

---

(b) Which part of the cell is similar in function to the human's brain? Explain your answer. [1]

---



---

33. The diagrams below show the different stages of the growth of a bean seed.

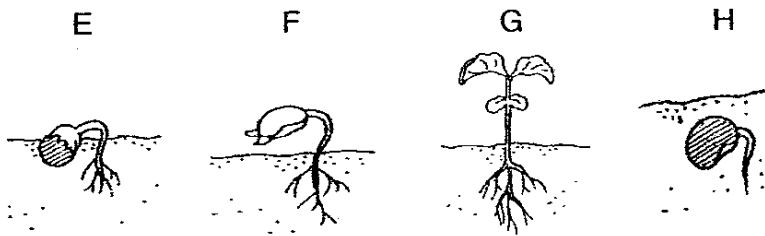

(a) Arrange the growth of a green plant in the correct order to show how a bean seed grows into a seedling. [1]



(b) Where does the seedling obtain its nutrients at stage E? [1]

---

(Go on to the next page)

34. When a hibiscus leaf was immersed in a beaker of hot water, more bubbles were observed on one of the leaf surfaces as shown below.

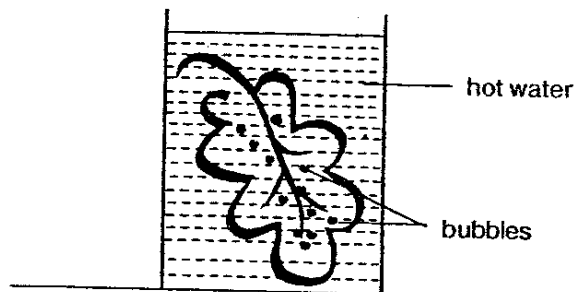

- (a) Would the upper or lower surface of the hibiscus leaf have more bubbles? [1]

---

- (b) Explain your answer in (a). [1]

---

---

(Go on to the next page)

35. The chart below shows how protein is digested in the different regions of the human body. The width of each band (black shaded area) indicates the amount of food present in that part of the digestive tract.

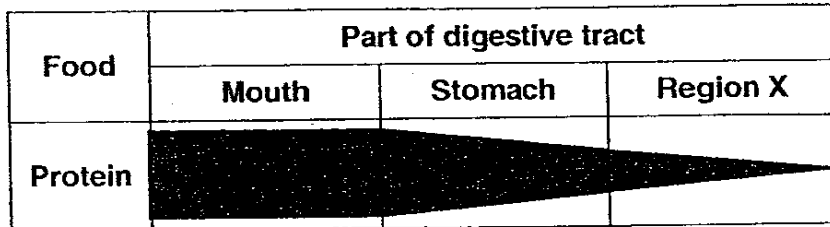

- (a) Which part of the body is region X? [1]

---

- (b) Based on the above chart, write "Fully digested", "Partially digested" or "Not digested at all" in each of the boxes to describe what happens to protein in the mouth and stomach. [1]

Part of digestive tract	"Fully digested", "Partially digested" or "Not digested at all"
Mouth	
Stomach	

- (c) Besides digestion, what other process also occurs in region X? [1]

---

(Go on to the next page)

36. Study the food web and answer the questions below.

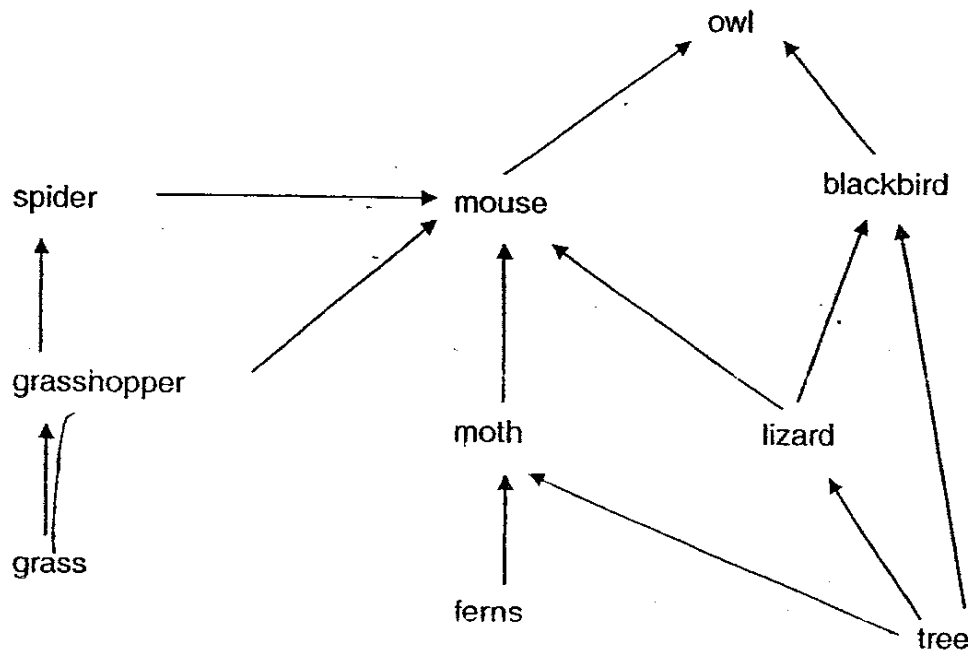

(a) How many food chains are interconnected in the above food web? [1]

\_\_\_\_\_

(b) If all the mice were killed, would the population of tree be affected? Give reasons to support your answer. [2]

\_\_\_\_\_  
\_\_\_\_\_  
\_\_\_\_\_

(c) If you want to reduce the population of spiders in a shortest period of time, how would you change the population size of two other organisms in the above food web? [1]

\_\_\_\_\_  
\_\_\_\_\_

(Go on to the next page)

37. Mrs Ong studied the concentration of oxygen, the number of bacteria and the number of fish in a river. Along the river, a factory which dumped sewage waste was situated a distance downstream from Point X.

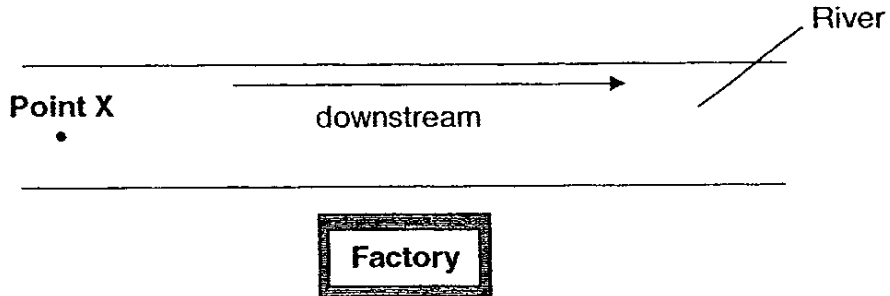

She made her measurements over a distance of 50 km from Point X. Her results were represented in a graph as shown below.

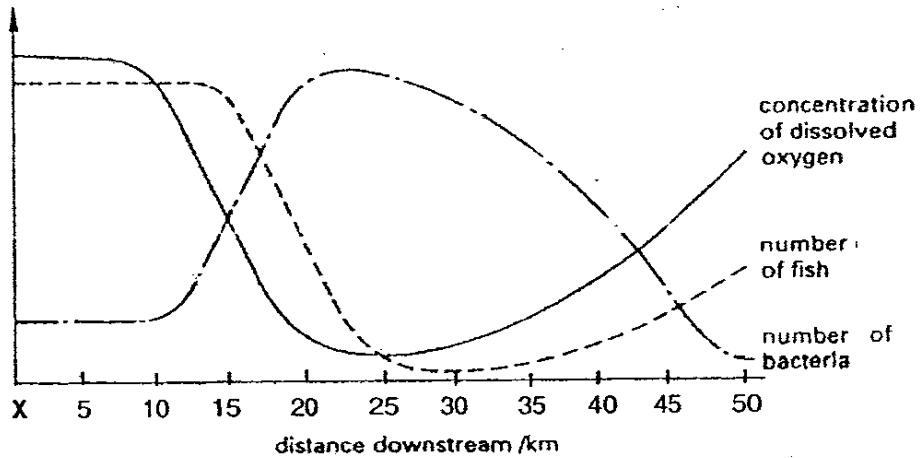

- (a) At what distance from point X did the river become polluted? [1]

---

- (b) Based on the graph above, describe the negative effects of polluting the river with sewage. [2]

---



---



---



---

(Go on to the next page)

38. Siti wanted to pour some condensed milk. She punched a small hole in one tin and two holes in another tin as shown in the diagram below.

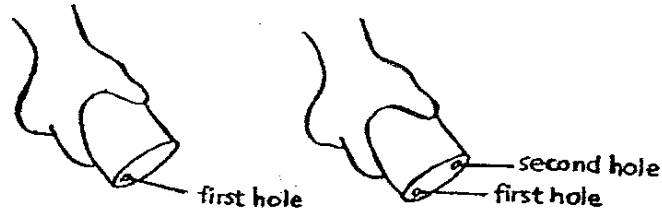

Tin X

Tin Y

In which tin (X or Y), would the condensed milk flow out faster? Explain your answer. [2]

---



---



---

39. The properties of different types of plastics were tested in a factory and the results are shown in the table below.

Property	Plastic E	Plastic F	Plastic G	Plastic H
Lightweight	Yes	Yes	Yes	No
Waterproof	Yes	Yes	No	Yes

Based on his conclusion, Plastic F was the most suitable material for school bags. Explain why. [2]

---



---



---

(Go on to the next page)

40. Jeremy had 5 set-ups V, W, X, Y and Z. He conducted two different fair tests to find out the factors affecting the rate of evaporation of water.

Set-up	V	W	X	Y	Z
Volume of water (ml)	400	200	200	400	200
Temperature of water ( $^{\circ}\text{C}$ )	30	55	35	30	60
Exposed surface area ( $\text{cm}^2$ )	10	15	10	15	10

- (a) What would be the aim of the fair test if he had used set-ups V and Y? [1]

---

---

- (b) If he wanted to find out whether temperature of water affected the rate of evaporation, which two other set-ups would he use? [1]

---

(Go on to the next page)

41. Diagrams I and II show two circuits that were used to compare the electrical properties of two different materials X and Y. Identical batteries and bulbs were used in both circuits.

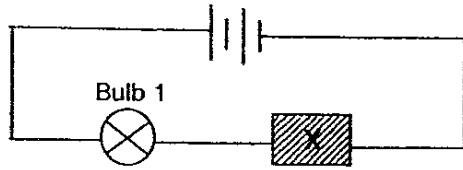

Diagram I

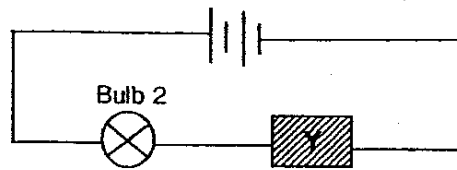

Diagram II

Observations were made on the brightness of the bulbs and recorded in the table below.

Bulb	Brightness of the bulb
1	Bright
2	No light

- (a) Based on the table, what electrical property do materials X and Y have? [1]

(i) Material X : \_\_\_\_\_

(ii) Material Y : \_\_\_\_\_

- (b) Describe how material Y can be useful to us. [1]

\_\_\_\_\_

\_\_\_\_\_

- (c) In the diagram below, draw wires to show how the circuit in Diagram I was connected. [1]



(Go on to the next page)



42. Mohan built a tunnel and placed two mirrors at two corners as shown below. An object was placed facing one mirror. Mohan stood facing the other mirror so that he could see the image of the object. He noticed that he had to change his position in order to see the image of the object whenever the mirrors were placed at different angles.

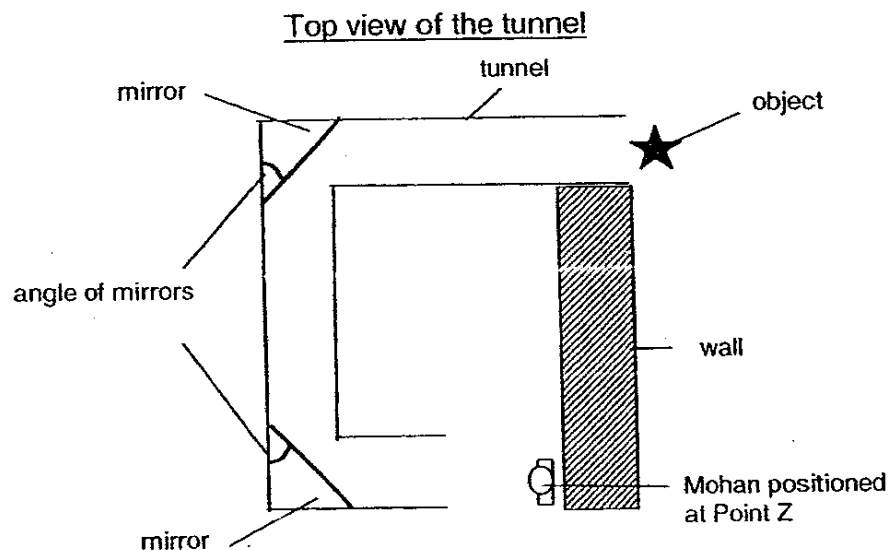

He recorded the angles at which the mirrors were placed and the distance he moved along the wall from Point Z. The results were tabulated below.

Angle of mirrors ( $^{\circ}$ )	Distance between Mohan and Point Z (cm)
45	0
48	10
50	20
55	30

- (a) What is the relationship between the angle of mirrors and the distance between Mohan and Point Z along the wall? [1]

---



---

- (b) If the angle of the mirrors was  $90^{\circ}$ , what observation would likely be made about the image of the object? [1]

---

(Go on to the next page)

43. Denise immersed a sealed bottle of hot milk into a container of cold water as shown below.

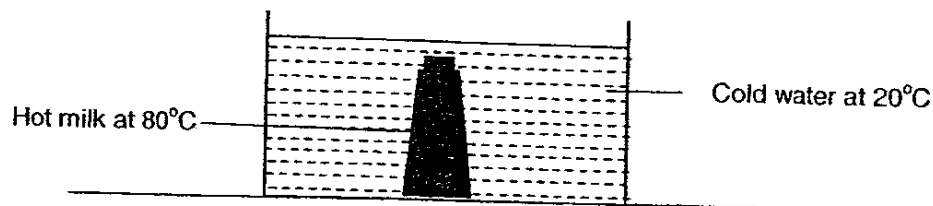

The temperature of the cold water was measured at regular intervals for 15 minutes and plotted in the graph shown below.

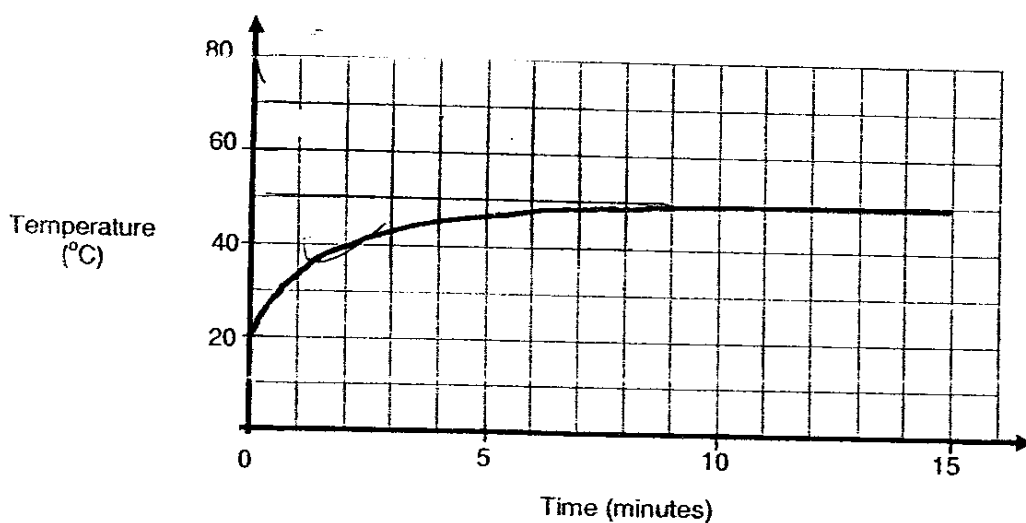

- (a) What was the final temperature of the cold water during the 15-minute period? [1]
- 
- (b) On the same axes, plot the graph to show the changes in the temperature of the hot milk for the 15-minute period. [1]
- (c) If the bottle was made of a poorer conductor of heat than before, how different would the rate of temperature change in the hot milk be? [1]
- 

(Go on to the next page)

44. Kim Sheng suspended three bars, X, Y and Z as shown in the diagram below. He observed how the three bars interacted with each other.

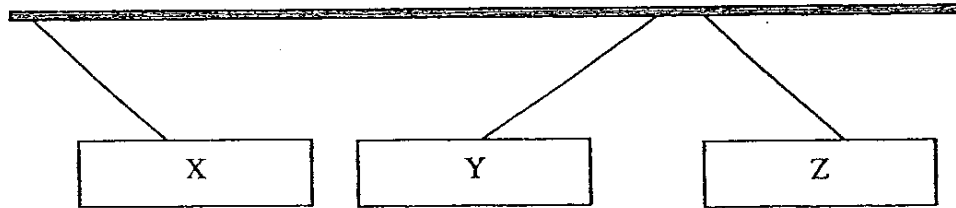

- (a) Based on his observation, which of the following bars, X, Y, Z can be confirmed to be magnets? [1]

---

- (b) Give a reason to support your choice in (a). [1]

---

---

---

(Go on to the next page)

45. Ali transported a load across a block from a lower floor to a higher floor as shown as below.

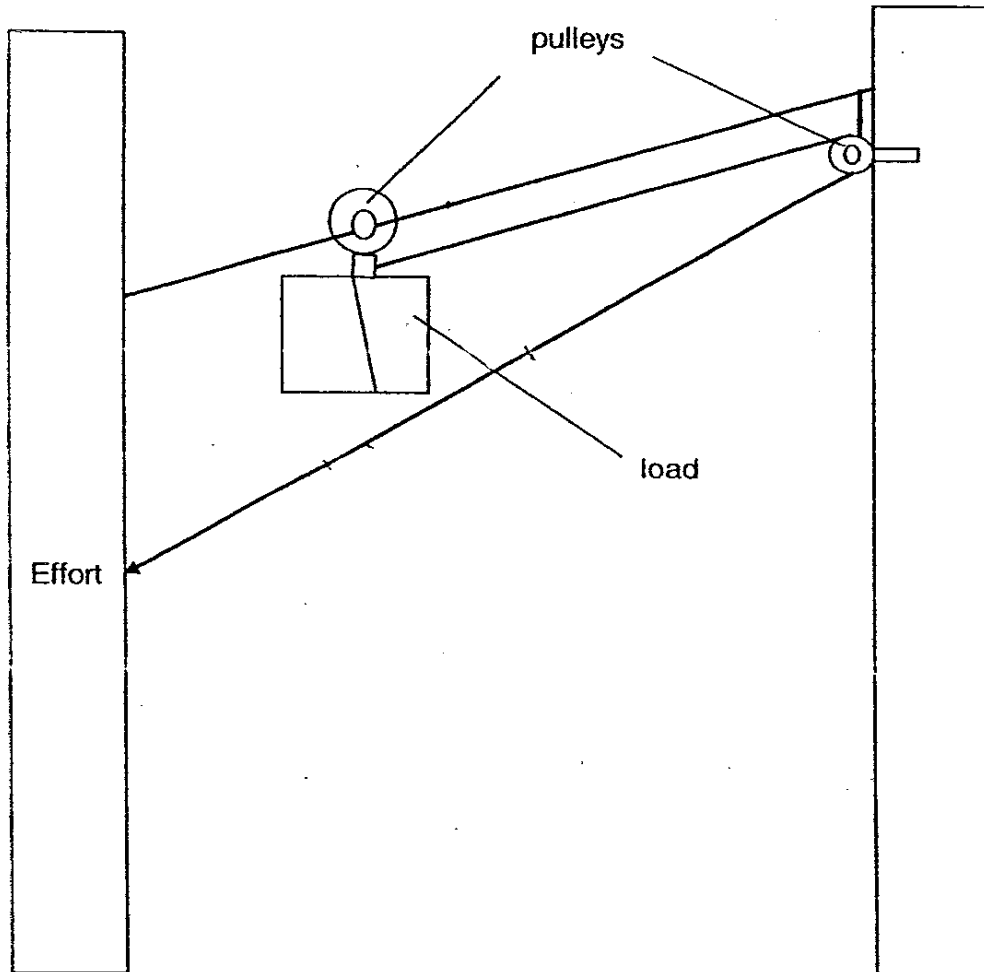

- (a) In the above situation, name two types of simple machines that had enabled the effort to be reduced. [1]
- 
- (b) Draw arrows in the diagram above to indicate the forces that are acting on the load. [1]

(Go on to the next page)

46. Kok Beng had two set-ups, Q and R, and blocks of equal masses.

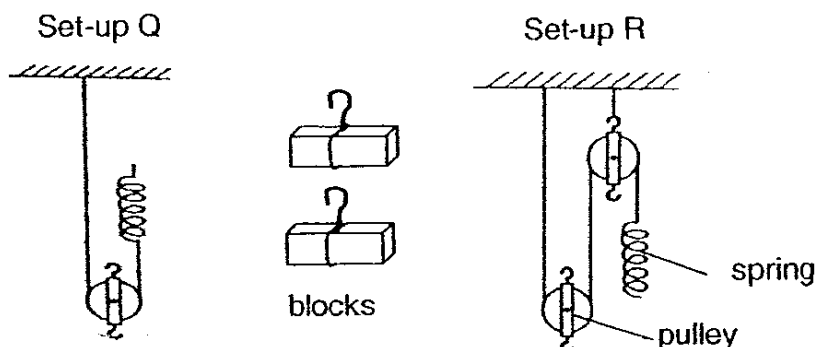

- (a) He predicted that more effort would be needed using set-up Q than set-up R to lift a load. Describe in the table below, how he would confirm his prediction. [You are not allowed to use any other apparatus. You may draw your experiment in the table below.] [2]

--	--

- (b) What observation would confirm his prediction? [1]

---



---

- (c) What should he do to ensure that the results obtained are reliable? [1]

---

End of Part II

Rosyth Primary School  
Primary 6 Science Preliminary Exams (2006)

(ANSWER KEY)

SECTION A : (60 MARKS)

Qn no.	Ans
1	3
2	4
3	2
4	2
5	3
6	3
7	1
8	3
9	1
10	2

Qn no.	Ans
11	3
12	1
13	4
14	4
15	4
16	4
17	2
18	1
19	4
20	3

Qn no.	Ans
21	4
22	2
23	4
24	2
25	4
26	2
27	4
28	2
29	2
30	2

3

SECTION B (40 MARKS)

Qn No.	Answers
31a	The adult stage mosquitoes can sting people and can pass diseases such as dengue fever.
31b	We can clear stagnant water in our vases or pots daily to get rid of the mosquitoes at an early stage.

32a	It would have irregular shape.
32b	The nucleus. It controls all the activities within the cell.

33a	H → E → F → G
33b	It obtains its nutrients from its seed leaves.

34a	The lower surface of the hibiscus leaf has more bubbles.
34b.	There are less stomata found on the up surface than the lower surface.

Qn No.	Answers
35a	Small intestine
35b	Mouth : partially digested Stomach : partially digested
35c	Water taken

36a	7
36b	Yes, if the mice were killed, the moths and lizards would increase and if the lizards increase, the black bird will also increase, since they eat trees, thus the population of trees would decrease.
36c	I would increase the number of mice and reduce the number of grasshoppers.

37a.	10km
37b.	The pollution of the river will decrease the concentration of dissolved oxygen and increase the number of bacteria thus causing the number of fish to decrease.

38.	Tin X has only one hole to let the air enter in, but Tin Y has 2 holes, so more air enter in. Thus have more space and push more milk out.
-----	--

39.	Plastic F is lightweight and waterproof so if the user accidentally spills water on it. It will not wet and if the user is very weak. He does not need to carry such a heavy bag.
-----	---

40a.	The aim would be to find out if the exposed surface area would affect the rate of evaporation.
40b.	X and Z

41a	X : conductor of electricity. Y : insulator of electricity,
41b.	They can help us to cover the wires so if we accidentally touch it, we will not get electrocuted.

Qn No.	Answers
42a	The greater the angle of mirrors, the greater the distance between and point 2 along the wall.
42b.	It cannot be seen.

43a	50°C
43b.	
43c.	The rate of temperature change would be slower.

44a	Y and Z
44b	Bar Z repelled bar Y

45a	The movable and fixed.
45b.	

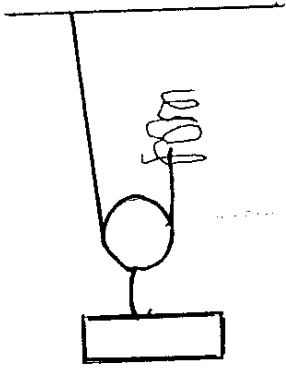
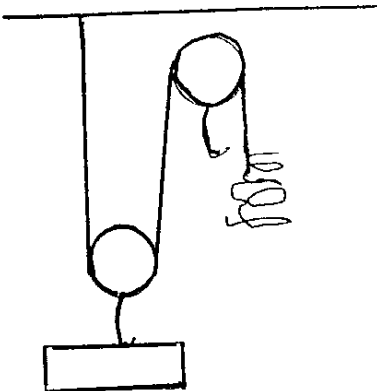

46a.	<div style="display: flex; justify-content: space-around; align-items: center;"> <div style="text-align: center;"> <p>Q</p>  </div> <div style="text-align: center;"> <p>R</p>  </div> </div>
	1) Attach a block to set-up Q
	2) Raise the load by pulling the spring
	3) Observe the length of the string when pulled to lift the load
	4) Repeat the steps for set-up R.
46b.	The spring that stretches the longest is the set-up that requires more effort to lift a load.
46c.	He should repeat it a few times.