



Rosyth School
Term Assessment 2024 (Term 1)
Mathematics
Primary 6
Paper 1

Name: _____

Register No. _____

Class: Pr 6 - _____

Date: 27 February 2024

Parent's Signature: _____

Total Time for Booklets A and B : 1 hour

BOOKLET A

Instructions to Pupils:

1. Do not open this booklet until you are told to do so.
2. Follow all instructions carefully.
3. Shade your answers in the Optical Answer Sheet (OAS) provided.
4. You are **not** allowed to use a calculator.
5. Answer all questions.

Section	Maximum Mark	Marks Obtained
Paper 1 (Booklet A)	20	

* This booklet consists of 7 pages (including this cover page).

Questions 1 to 10 carry 1 mark each. Questions 11 to 15 carry 2 marks each. For each question, four options are given. One of them is the correct answer. Make your choice (1, 2, 3 or 4). Shade the oval (1, 2, 3 or 4) on the Optical Answer Sheet.

All diagrams in this paper are not drawn to scale unless stated otherwise.
(20 marks)

1. There were 124 089 visitors to a tourist attraction last year. Express this number to the nearest thousand.

- (1) 100 000
(2) 120 000
(3) 124 000
(4) 125 000

()

2. What is the value of $10 \div 2000$?

- (1) 200
(2) 20
(3) 0.05
(4) 0.005

()

3. Part of a scale is shown below. What is the value of the reading at X?

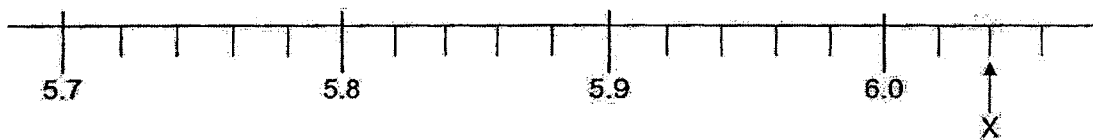

- (1) 6.02
(2) 6.04
(3) 6.2
(4) 6.4

()

4. Arrange the following fractions from the smallest to the largest:

$$\frac{5}{4}, 1\frac{1}{7}, \frac{11}{10}$$

(1) $1\frac{1}{7}, \frac{11}{10}, \frac{5}{4}$

(2) $\frac{5}{4}, \frac{11}{10}, 1\frac{1}{7}$

(3) $\frac{11}{10}, \frac{5}{4}, 1\frac{1}{7}$

(4) $\frac{11}{10}, 1\frac{1}{7}, \frac{5}{4}$ ()

5. The ratio of two different numbers is 3 : 2. The larger number is 60.
What is the smaller number?

(1) 20

(2) 24

(3) 30

(4) 40 ()

6. Mary collected 36 stamps. Her sister collected 12 fewer stamps than her.
Find the ratio of Mary's number of stamps to her sister's number of stamps.

(1) 2 : 3

(2) 3 : 1

(3) 3 : 2

(4) 3 : 4 ()

7. The figure below shows 10 identical cubes which are glued together to form a solid.

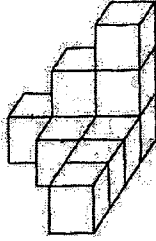

The whole solid, including the base, is then painted red. How many cubes have three of their faces painted red?

- (1) 7
 - (2) 2
 - (3) 3
 - (4) 9
- ()

8. Lükman donated 20% of his savings and still had \$380 of his savings left. How much money did he donate?

- (1) \$76
 - (2) \$95
 - (3) \$285
 - (4) \$304
- ()

9. The parallelogram below is not drawn to scale. $\angle q$ is twice of $\angle p$. What is the value of $\angle p$?

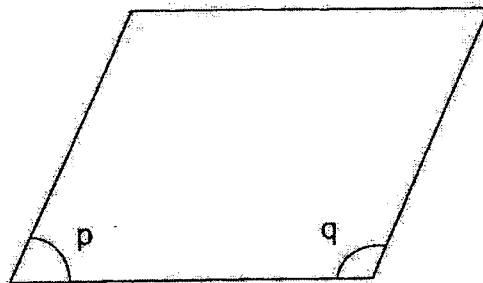

- (1) 120°
 - (2) 90°
 - (3) 60°
 - (4) 30°
- ()

10. WX and YZ are straight lines.

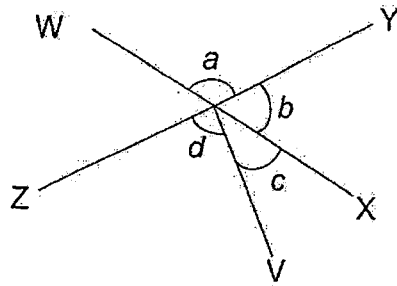

Which of the following is true?

- (1) $\angle a = \angle b + \angle c$
 (2) $\angle d = \angle a + \angle b$
 (3) $\angle a + \angle b + \angle c = 180^\circ$
 (4) $\angle b + \angle c + \angle d = 180^\circ$

()

11. The airmail rates to two countries are shown below.

Mass step	Vietnam	Japan
First 20 g	\$0.95	\$1.55
Every additional 10 g	\$0.25	\$0.35

Wakeen sent a letter weighing 43 g to Vietnam and a letter weighing 10 g to Japan by airmail. How much did he pay altogether?

- (1) \$1.70
 (2) \$2.75
 (3) \$3.25
 (4) \$3.70

()

12. The table below shows the different courses some children in a swimming club are attending.

	Boys	Girls
Beginner course	6	8
Advanced course	10	16

What percentage of the boys in the club attend the advanced course?

- (1) 10%
 (2) 25%
 (3) 37.5%
 (4) 62.5%

()

13. JKLM is a parallelogram. $\angle JML = 80^\circ$ and $\angle JOK = 120^\circ$ and $\angle JKM = 35^\circ$. Find $\angle MJL$.

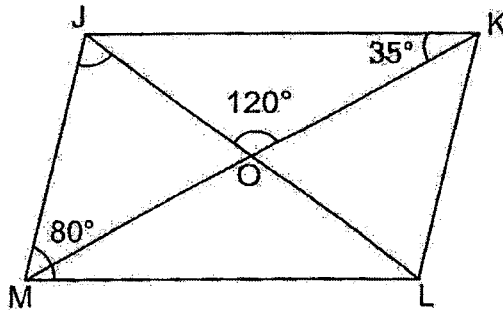

- (1) 25°
 (2) 40°
 (3) 55°
 (4) 65°

()

14. The figure below is made up of a circle A and a rhombus B. The area of the shaded part is $\frac{2}{5}$ of the area of A. The ratio of the area of the shaded part to the area of B is 3 : 8. What is the ratio of the area of the shaded part to the whole area of the figure?

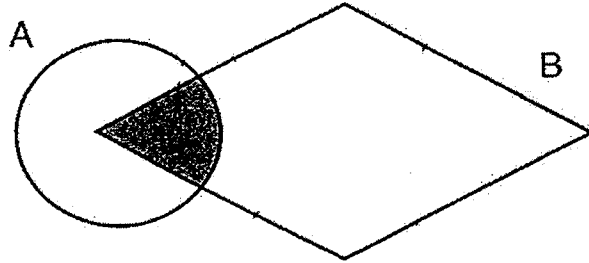

- (1) 6 : 25
- (2) 6 : 31
- (3) 12 : 31
- (4) 5 : 13

15. The figure shows a trapezium ABCD where AD = CD and AD // BC. Find $\angle ADC$.

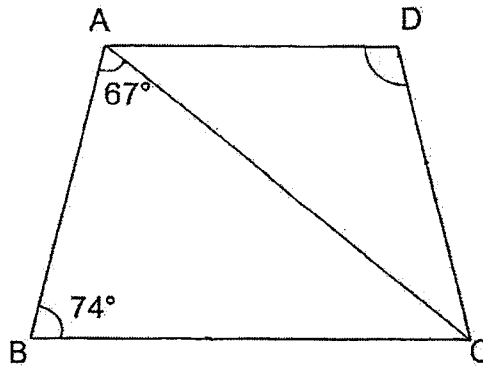

- (1) 39°
- (2) 74°
- (3) 102°
- (4) 141°

()



Rosyth School
Term Assessment 2024 (Term 1)
Mathematics
Primary 6
Paper 1

Name: _____

Register No. _____

Class: Pr 6 - _____

Date: 27 February 2024

Parent's Signature: _____

Total Time for Booklets A and B : 1 hour

BOOKLET B

Instructions to Pupils:

1. Do not turn over this page until you are told to do so.
2. Follow all instructions carefully.
3. Answer all questions.
4. Use a dark blue or black ballpoint pen to write your answers in the space provided for each question.
5. Do not use correction fluid/tape or highlighters.
6. You are **not** allowed to use a calculator.

Section	Maximum Mark	Marks Obtained
Paper 1 (Booklet B)	25	

* This booklet consists of 8 pages (including this cover page).

Questions 16 to 20 carry 1 mark each. Write your answers in the spaces provided. For questions which require units, give your answers in the units stated.

Do not write
in this space

All diagrams in this paper are not drawn to scale unless stated otherwise.

(5 marks)

16. Find the value of $\frac{5}{6} + \frac{1}{9}$.

Ans: _____

17. What is the missing number in the box?

$$12 : 15 = \square : 35$$

Ans: _____

18. Express 7.3 as a percentage.

Ans: _____ %

19. The figure below is made up of identical squares. Six of them are shaded. Shade two more squares so that AB is the line of symmetry for the figure.

Do not write in this space

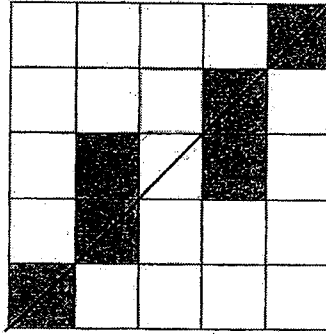

20. ABCD is a trapezium with AB parallel to DC. $\angle ADC = 112^\circ$. Find $\angle BAD$.

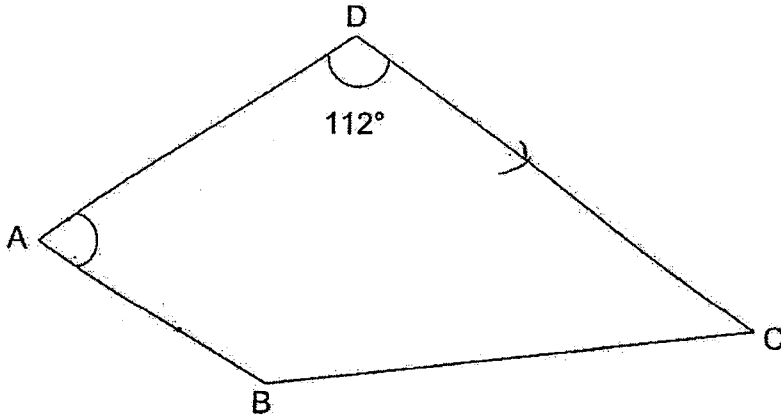

Ans: _____ °

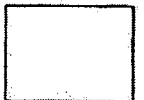

Questions 21 to 30 carry 2 marks each. Show your workings clearly in the space provided for each question and write your answers in the spaces provided. For questions which require units, give your answers in the units stated.

Do not write
in this space

All diagrams in this paper are not drawn to scale unless stated otherwise.
(20 marks)

21. Find the sum of all the common factors of 21 and 35.

Ans: _____

22. There are some pens in a container. $\frac{1}{3}$ of the pens are red. After Mr Lim added 15 red pens into the container, $\frac{4}{9}$ of the pens in the container are red. How many red pens did Mr Lim have in the container at first?

Ans: _____

23. Find the perimeter of the quarter circle below. Take $\pi = \frac{22}{7}$.

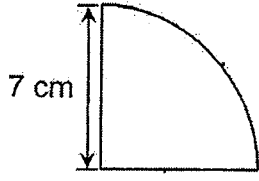

Do not write in this space

Ans: _____ cm

24. Using the square grid below, draw and label an isosceles triangle WXY. $\angle XYZ = 45^\circ$ and $WX = WY$. Measure the length of WX.

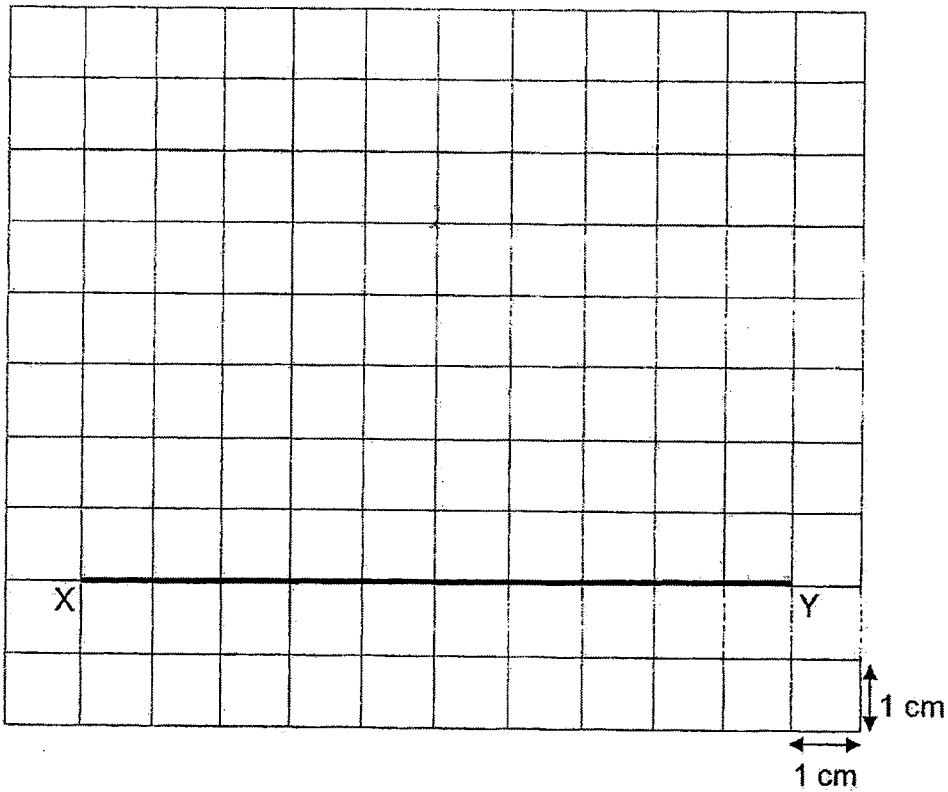

Ans: _____ cm

25. In the diagram below, the length of DE is twice the length of EA. G is the mid-point of AB and $AE = AG$. EFG and DCH are isosceles triangles. What fraction of the figure is shaded? Give your answer in the simplest form.

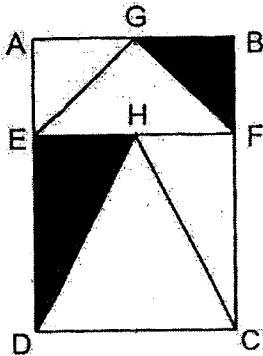

Do not write in this space

Ans: _____

26. The library had 17 shelves with an equal number of books on each shelf. Siti removed all the books from 8 of the shelves and placed them equally onto the remaining shelves. She found that these remaining shelves had 24 more books each. How many books were on each shelf at first?

Ans: _____

27. Containers A, B and C had an equal amount of water at first. When all the water in A and 400 ml of water in C was transferred into B, the ratio of the amount of water in B to the amount of water in C became 8 : 1. How much water was there in each container at first?

Do not write
in this space

Ans: _____ ml

28. A school has 1500 pupils. 40% of them are girls. 60% of the boys go to school by bus. How many boys go to school by bus?

Ans: _____

29. A triangle PQR is drawn inside a box. By joining the dots on the grid with straight lines, draw a rectangle QRST such that its area is 2 times the area of triangle ~~ABC~~
PQR.

Do not write in this space

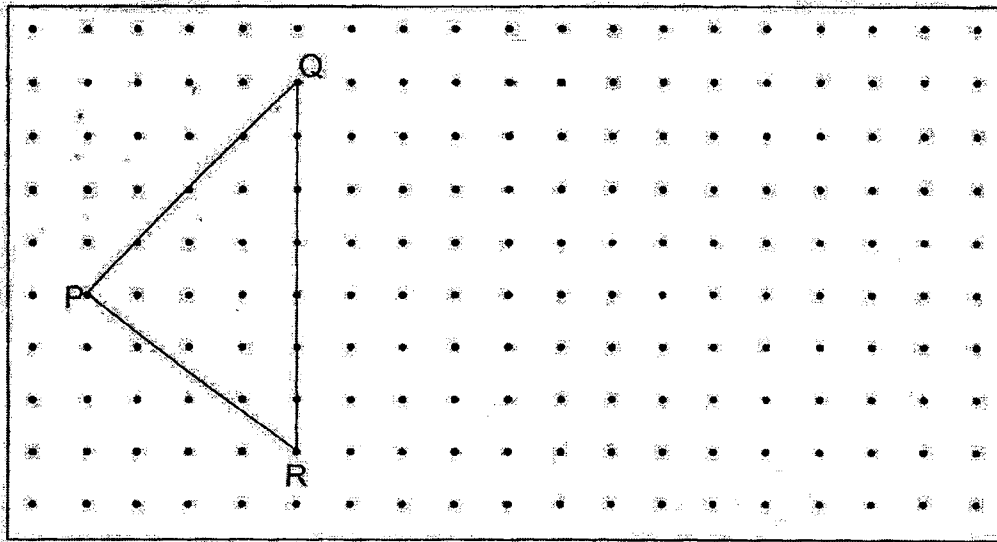

30. Every month, Gary saved \$300 of his salary and spent the rest. In December, his spending increased by 4% and he only managed to save \$240. How much was his salary?

Ans: \$ _____

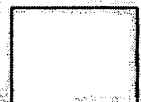

End of paper
Have you checked your work?



Rosyth School
Term Assessment 2024 (Term 1)
Mathematics
Primary 6
Paper 2

Name: _____

Register No. _____

Class: Pr 6 - _____

Date: 27 February 2024

Parent's Signature: _____

Time: 1 h 30 min

Instructions to Pupils:

1. Do not turn over this page until you are told to do so.
2. Follow all instructions carefully.
3. Answer all questions.
4. Use a dark blue or black ballpoint pen to write your answers in the space provided for each question.
5. Do not use correction fluid/tape or highlighters.
6. The use of an approved calculator is allowed.

Questions	Maximum Mark	Marks Obtained
Q 1 to 5	10	
Q 6 to 17	45	

Section	Maximum Mark	Marks Obtained
Paper 1	45	
Paper 2	55	
Total	100	

* This booklet consists of 15 pages (including this cover page)

Questions 1 to 5 carry 2 marks each. Show your working clearly in the space provided for each question and write your answers in the spaces provided. For questions which require units, give your answers in the units stated.

(10 marks)

All diagrams in this paper are not drawn to scale unless stated otherwise.

Do not write
in this space

1. The semicircle below has a diameter of 15 cm.
Using the calculator value of π , find its area, correct to 2 decimal places.

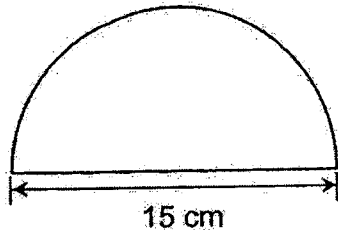

Ans: _____ cm²

2. A choir has 40 male members and 65 female members. 15% of the male members and 20% of the female members are students. What percentage of the members are students?

Ans: _____ %

3. A school stage is decorated with a banner made up of 263 red and white triangles. One end of the banner is shown below. There are at least 3 red triangles between any 2 white triangles. What is the largest possible number of white triangles on the banner?

Do not write
in this space

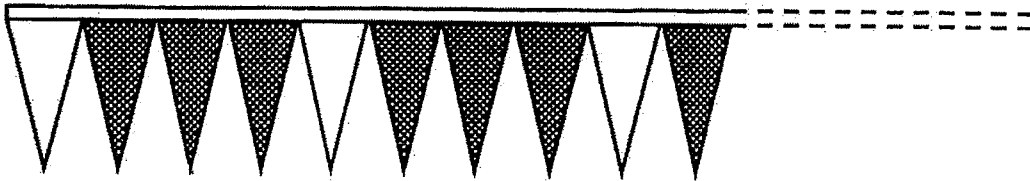

Ans: _____

4. Ahmad, Banu and Caili had a total of 725 marbles. Bala had four times as many marbles as Ahmad. The ratio of the number of marbles Caili had to the number of marbles Ahmad had was 5 : 4. How many marbles did Banu have?

Ans: _____

5. The figure below shows two straight lines AB and BC.

(a) Draw 2 lines to form a parallelogram ABCD. Label Point D.

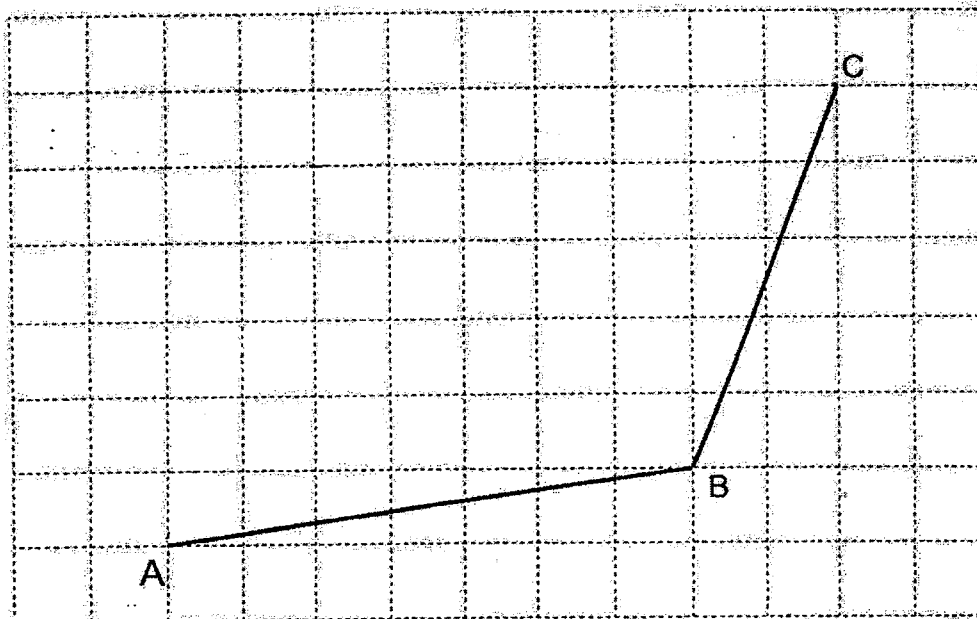

(b) Measure $\angle ABC$.

Do not write
in this space

Ans: (b) _____°

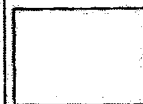

For Questions 6 to 17, show your working clearly in the space provided for each question and write your answers in the spaces provided. The number of marks available is shown in brackets [] at the end of each question or part-question. For questions which require units, give your answers in the units stated. (45 marks)

Do not write
in this space

All diagrams in this paper are not drawn to scale unless stated otherwise.

6. Gina had 56 more stamps than John. When John gave Gina 22 of his stamps, Gina had 5 times as many stamps as John. How many stamps did John have at first?

Ans: _____ [3]

7. Jean, Nancy and Francis had a number of sweets in the ratio 5 : 2 : 6. After Francis gave 30% of his sweets to Jean and Nancy, the number of sweets that Nancy had increased by 50%. What is the ratio of sweets Jean had to the number of sweets Nancy had in the end?

Do not write in this space

Ans: _____ [3]

8. Mrs Teo and Mr Lim bought the same type of washing machine from a store. Mrs Teo paid \$720 for her washing machine after a 20% discount. However, Mr Lim only paid \$585 for his washing machine after the discount. What was the percentage discount given to Mr Lim?

Ans: _____ [3]

9. In the figure below, a rectangular piece of paper is folded at the top 2 corners W and Y as shown. What is the value of $\angle WXY$?

Do not write in this space

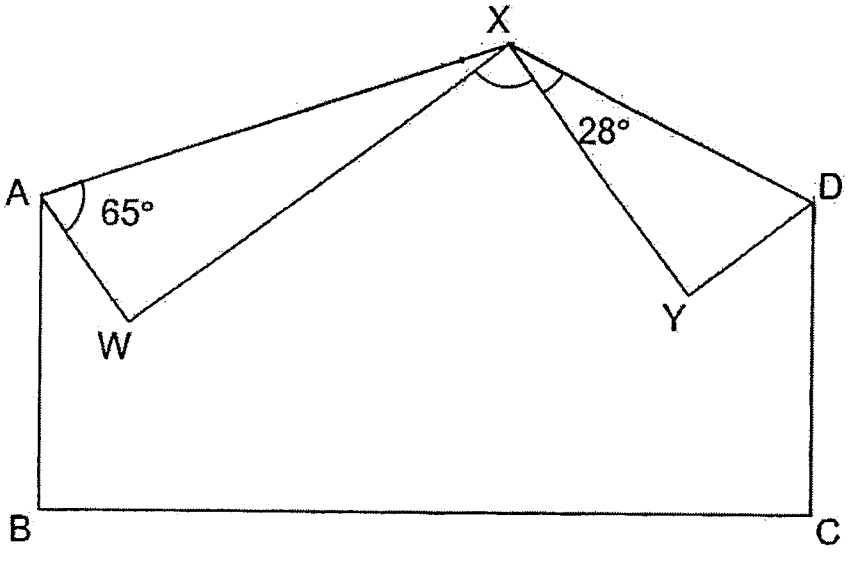

Ans: _____ [3]



10. In the figure below, triangle AXB and triangle AYB are drawn within a square ABCD. The area of the square is 100 cm^2 . The length of ST is $\frac{2}{5}$ of the length of AB. Find the total area of the shaded parts.

Do not write
in this space

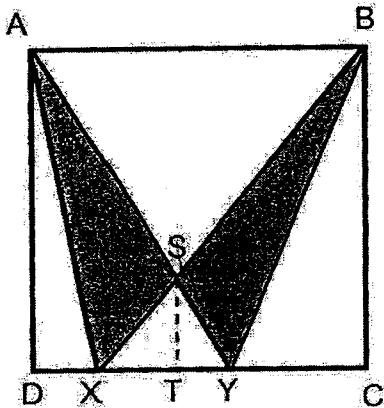

Ans: _____ [3]

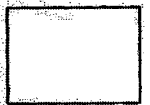

11. Bag A had 1.9 kg of rice and Bag B had 2.28 kg of rice. After an equal mass of rice was taken from both bags, the mass of rice in Bag A became 30% of the total mass of rice left in both bags. Find the total mass of rice removed, in kg, from both bags.

Do not write
in this space.

Ans: _____ [4]

12. ABCD and ABCE are two trapeziums. GDF is an isosceles triangle. AFD and CFE are straight lines. $\angle CDF = 43^\circ$ and $\angle EAF = 64^\circ$.

Do not write in this space

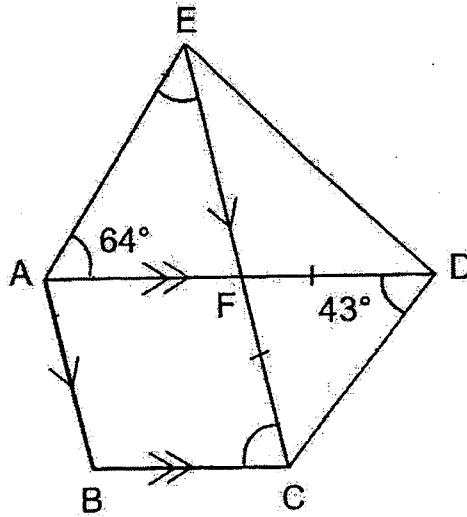

(a) Find $\angle FCB$.

Ans: (a) _____ [2]

(b) Find $\angle AEC$.

Ans: (b) _____ [2]

13. In Country X, the height of six 10-cent coins is the same as the height of five 20-cent coins as shown in diagram 1. Diagram 2 shows an unknown number of such 10-cent coins stacked to the same height as another stack of such 20-cent coins. The total value of the 2 stacks of coins in Diagram 2 is \$88.

Do not write in this space

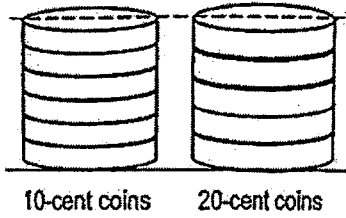

Diagram 1

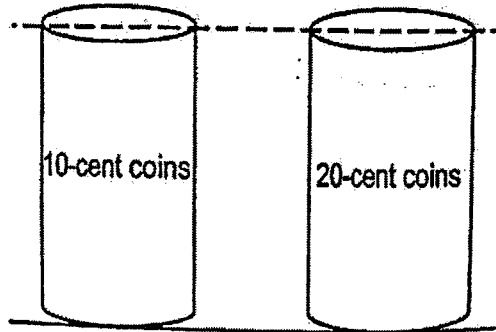

Diagram 2

- (a) Find the number of 10-cent coins used in Diagram 2.

Ans: (a) _____ [2]

- (b) Find the value of all the 20-cent coins used in Diagram 2.

Ans: (b) _____ [2]

14. A band held a two-night concert. 150 more male adults than female adults attended the concert on the first night. For the second night concert, the number of female adults decreased by 15% and the number of male adults increased by 30%. A total of 1270 adults attended the concert on the second night. Find the total number of adults who attended the concert over two nights.

Do not write
in this space

Ans: _____ [4]

15. EFGH is a square and EFK is an equilateral triangle.

Do not write
in this space

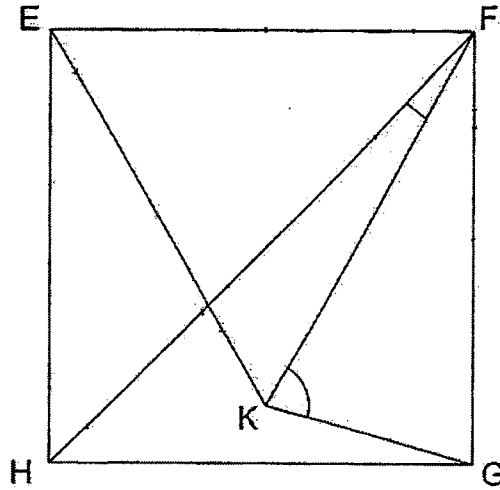

(a) Find $\angle HFK$.

Ans: (a) _____ [2]

(b) Find $\angle FKG$.

Ans: (b) _____ [2]

16. Adam had some money. He spent $\frac{2}{5}$ of it on 3 identical pens. He bought another 2 of such pens and 15 identical erasers with the rest of his money.

Do not write
in this space

- (a) What fraction of his money was spent on the 15 erasers? Express your answer in its simplest form.

Ans: (a) _____ [2]

-
- (b) In a sale, Adam would be given 1 free eraser for every 6 erasers bought. How many erasers would he get altogether if he had spent all his money on the erasers?

Ans: (b) _____ [3]

17. There are 48 boys in Badminton Club and 16 boys in Tennis Club. There are 2 more students in Badminton Club than in Tennis Club. The number of girls in Badminton Club is 75% of the number of girls in Tennis Club.

Do not write
in this space

- (a) How many girls are there in Tennis Club?

Ans: (a) _____ [2]

-
- (b) Some girls ^{left +} joined the Tennis Club. As a result, 32% of the students in the Tennis Club were boys. What is the ratio of the total number of boys to the total number of girls now?

Ans: (b) _____ [3]

End of paper
Have you checked your work?

1. 10/10/98

2.

3.

4.

5.

SCHOOL : ROSYTH SCHOOL
 LEVEL : PRIMARY 6
 SUBJECT : MATH
 TERM : 2024 WA1

Q1	Q2	Q3	Q4	Q5	Q6	Q7	Q8	Q9	Q10
3	4	2	4	4	3	3	2	3	4
Q11	Q12	Q13	Q14	Q15					
3	4	4	1	3					

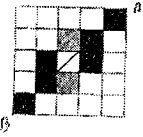
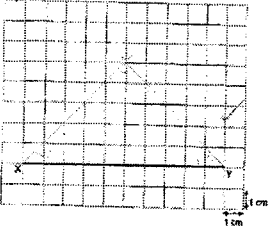
Q16)	$\frac{17}{18}$
Q17)	28
Q18)	730%
Q19)	
Q20)	60°
Q21)	8
Q22)	25
Q23)	25cm
Q24)	 7.1cm
Q25)	$\frac{1}{4}$
Q26)	27
Q27)	600ml
Q28)	540

Q29)

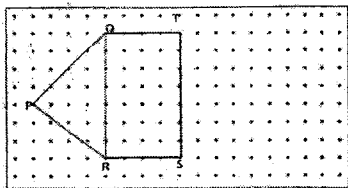

Q30)

\$1800

Rosyth Primary School Term 1 Math WA 2024 CP6)

Paper 2

Q1) $d = 15$

$r = 15 \div 2$

$= 7.5$

Area = $\pi \times r \times r \times \frac{1}{2}$

$= \pi \times 7.5 \times 7.5 \times \frac{1}{2}$

$\approx 88.36 //$

Q2) Male students $\rightarrow \frac{15}{100} \times \frac{40}{1}$
 $= 6$

Female students $\rightarrow \frac{20}{100} \times \frac{65}{1}$
 $= 13$

No. of students = $6 + 13 = 19$

Total members = $40 + 65 = 105$

% of students = $\frac{19}{105} \times 100\%$
 $\approx 18.10\% //$

Q3) $263 \div 4 = 65 \text{ R } 3$
 (groups)

No. of white $\Delta = 65 \times 1 + 1$
 $= 66 //$

Q4) A : B : C : Total

$\times 4 \left(\begin{array}{l} 1 : 4 \\ 4 : 16 \end{array} \right) \times 4$

4 : 16 : 5

4 : 16 : 5 : 25

$25u \rightarrow 725$

$1u \rightarrow 725 \div 25$
 $= 29$

$16u \rightarrow 29 \times 16$
 $= 464 //$

Q5) (a)

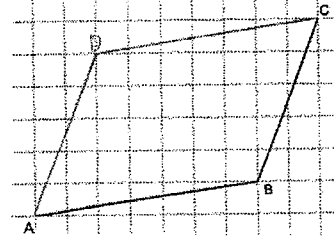

(b) $120^\circ //$

Q6) $\begin{array}{|c|c|c|} \hline G & 14 & 22 \\ \hline J & 14 & 22 \\ \hline \end{array}$ $\leftarrow 4u$

$4u \rightarrow 22 + 56 + 22 = 100$

$1u \rightarrow 100 \div 4 = 25$

$J \rightarrow 25 + 22 = 47 //$

Q7) $\frac{J : N : F}{5 : 2 : 6}$

$\times 5 \rightarrow 25 : 10 : 30$

$\frac{+4 \quad +5 \quad -9}{29 : 15 : 21}$ (In the end)

F gave away $\rightarrow \frac{30}{100} \times 30u = 9u$

Ans: $29 : 15 //$

Q8) 80% (paid) $\rightarrow \$720$

1% $\rightarrow \$9$

100% $\rightarrow \$900$

Discount $\rightarrow \$900 - \585
 $= \$315$

% discount $\rightarrow \frac{\$315}{\$900} \times 100\%$

$= 35\% //$

$$\begin{aligned} \text{Q9)} \quad \angle ZXW &\rightarrow (90^\circ - 65^\circ) \times 2 = 50^\circ \\ \angle WXY &\rightarrow 180^\circ - 50^\circ - 28^\circ - 28^\circ \\ &= 74^\circ // \end{aligned}$$

$$\begin{aligned} \text{Q10)} \quad \triangle ABS &\rightarrow 6 \times 10 \div 2 = 30 \\ \triangle AXS + \triangle SYB \\ &= (100 \div 2 - 30) \times 2 \\ &= 40 \\ \text{Ans: } &40 \text{ cm}^2 // \end{aligned}$$

$$\begin{aligned} \text{Q11)} \quad A : B : \text{Difference} \\ 1.9 \text{ kg} : 2.28 \text{ kg} : 0.38 \text{ kg} \\ 3u : 7u = 4u \\ \text{Diff} \rightarrow 2.28 \text{ kg} - 1.9 \text{ kg} \\ = 0.38 \text{ kg} \\ 7u - 3u = 4u \\ 4u \rightarrow 0.38 \text{ kg} \\ 1u \rightarrow 0.095 \text{ kg} \\ 3u \rightarrow 0.285 \text{ kg (A left)} \\ \text{Removed} \rightarrow (1.9 - 0.285) \text{ kg} \\ = 1.615 \text{ kg} \\ \text{Total removed} = 1.615 \text{ kg} \times 2 \\ = 3.23 \text{ kg} // \end{aligned}$$

$$\begin{aligned} \text{Q12)} \quad (a) \quad \angle DCF &= 43^\circ \\ \angle CFD &= 180^\circ - 43^\circ - 43^\circ \\ &= 94^\circ \\ \angle AFE &= 94^\circ \text{ (vertically opposite)} \\ \angle FCB &= 94^\circ // \\ (b) \quad \angle AEF &= 180^\circ - 64^\circ - 94^\circ \\ &= 22^\circ // \end{aligned}$$

$$\begin{aligned} \text{Q13)} \quad 1 \text{ group} &= 6 \times \$0.10 + 5 \times \$0.20 \\ &= \$0.60 + \$1.00 \\ &= \$1.60 \\ \$88 \div \$1.60 &= 55 \text{ (groups)} \end{aligned}$$

$$(a) \quad 55 \times 6 = 330 //$$

$$(b) \quad 55 \times \$1.00 = \$55 //$$

Q14) 1st night

M	100%	150
F	100%	

2nd night

M	100%	150	30%	45	} 1270
F	85%				

$$\frac{150 \times 30}{100} = 45$$

$$\begin{aligned} 100\% + 85\% + 30\% &= 1270 - 150 - 45 \\ 215\% &= 1075 \\ 1\% &= 5 \end{aligned}$$

$$\text{1st night (100\%)} F = 5 \times 100 = 500$$

$$\text{1st night M} \rightarrow 500 + 150 = 550$$

$$\begin{aligned} \text{Total for two nights} &= 1270 + 500 + 550 \\ &= 2420 // \end{aligned}$$

Q15) $\angle EFH = 45^\circ$

$$(a) \quad \angle HFK = 60^\circ - 45^\circ = 15^\circ //$$

$$(b) \quad \angle KFG = 45^\circ - 15^\circ = 30^\circ$$

$$\begin{aligned} \angle FKG &= \frac{180^\circ - 30^\circ}{2} \text{ (isosceles } \triangle) \\ &= 75^\circ // \end{aligned}$$

Q16)

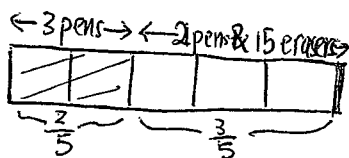

$$\begin{aligned} \text{(a) } 3 \text{ pens} &\rightarrow \frac{2}{5} \\ 1 \text{ pen} &\rightarrow \frac{2}{5} \div 3 \\ &= \frac{2}{5} \times \frac{1}{3} \\ &= \frac{2}{15} \end{aligned}$$

$$2 \text{ pens} = \frac{2}{15} \times 2 = \frac{4}{15}$$

$$\begin{aligned} 15 \text{ erasers} &= \frac{3}{5} - \frac{4}{15} \\ &= \frac{9}{15} - \frac{4}{15} \\ &= \frac{5}{15} \\ &= \frac{1}{3} \end{aligned}$$

$$\begin{aligned} \text{(b) } \frac{1}{3} \text{ money} &= 15 \text{ erasers} \\ \frac{3}{3} \text{ money} &= 15 \times 3 \\ &= 45 \text{ erasers} \end{aligned}$$

$$\begin{aligned} 45 \div 6 &= 7 \text{ R } 3 \\ &\downarrow \\ &(\text{7 groups}) \\ &\Rightarrow 7 \text{ free erasers} \end{aligned}$$

$$\begin{aligned} \text{Total erasers} &= 45 + 7 \\ &= 52 \end{aligned}$$

Q17)

Boys

B	16	32
T	16	

Girls

B	1u	1u	1u
T	1u	1u	1u

Total

B	16	32	34
T	16		44



B	16	34	30	2
T	16		44	

$$\begin{aligned} \text{(a) } 1u &= 30 \\ 4u &= 30 \times 4 \\ &= 120 \end{aligned}$$

(b) In the end:

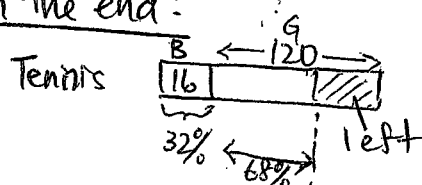

$$32\% \rightarrow 16$$

$$1\% \rightarrow \frac{1}{2}$$

$$68\% \rightarrow \frac{1}{2} \times 68 = 34 \text{ (girls left behind)}$$

$$\begin{aligned} \text{Girls in Badminton (3u)} &= 3 \times 30 \\ &= 90 \end{aligned}$$

$$\begin{aligned} \text{Total Girls} &= 90 + 34 \\ &= 124 \end{aligned}$$

$$\begin{aligned} \text{Total Boys} &= 48 + 16 \\ &= 64 \end{aligned}$$

$$B : G$$

$$64 : 124$$

$$16 : 31$$

$$\text{Ans} = 16 : 31$$

