



# RAFFLES GIRLS' PRIMARY SCHOOL

## PRELIMINARY EXAMINATION 2019

Section A	56
Section B	44
Your score out of 100 marks	
Parent's signature	

Name : \_\_\_\_\_ Index No: \_\_\_\_\_ Class: P 6

22 August 2019

**SCIENCE**

Attn: 1h 45min

### SECTION A (28 X 2 marks)

For each question from 1 to 28, four options are given. One of them is the correct answer. Make your choice (1, 2, 3 or 4). Shade the correct oval on the Optical Answer Sheet.

1. Which of the following characteristic(s) is/are generally common among amphibians and insects?
- A They have three body parts.
  - B Their young look like the adults.
  - C They reproduce by laying eggs.
  - D They have smooth and moist skin.
- (1) C only  
(2) D only  
(3) A and B only  
(4) A, B, C and D

2. The diagrams below show a mushroom and a fern.

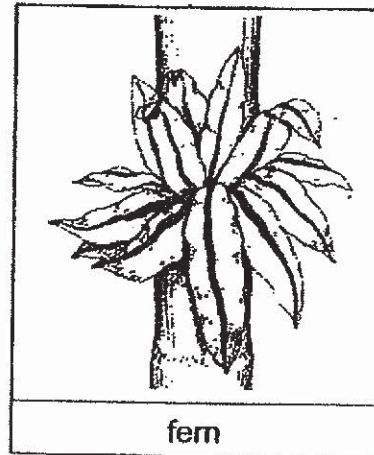
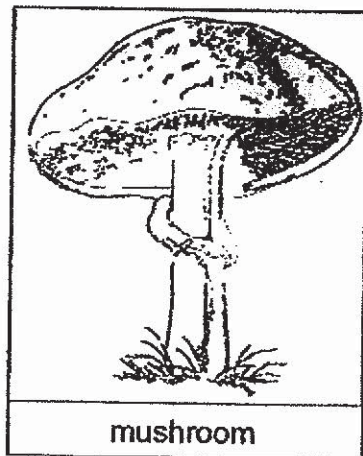

Which of the following comparison(s) between mushroom and fern is/are incorrect?

- A Both reproduce by spores.
  - B Mushroom can bear flowers but not fern.
  - C Mushroom can make its own food but not fern.
- (1) A only  
(2) C only  
(3) A and B only  
(4) B and C only

3. Study the life cycles of insects, X and Y, as shown below.

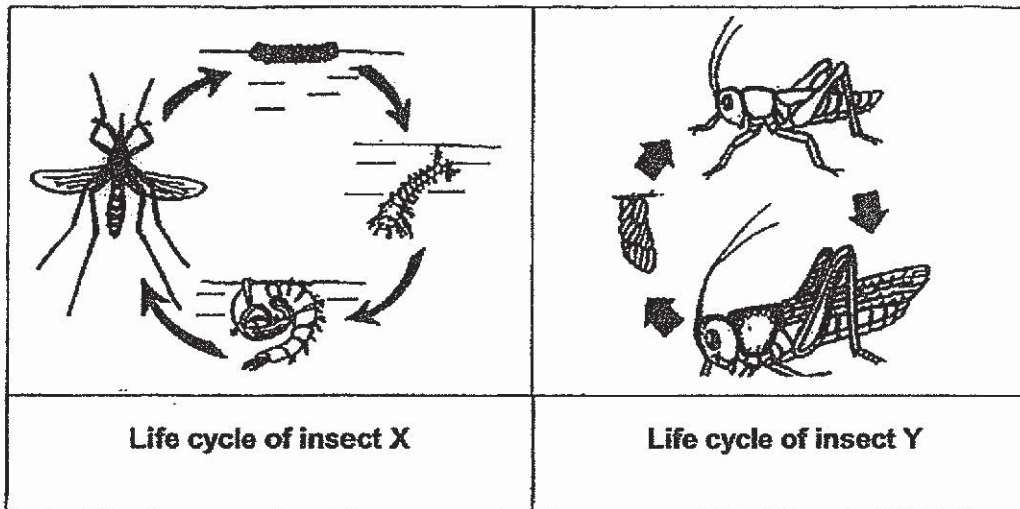

Based on the diagrams above, which of the following statements are true?

- A Both insects can live on land and in water.
- B Both insects have different number of stages in their life cycles.
- C The young of Y resembles its adult but not the young of X.
- D The young of X takes a longer time to develop into the adult stage than the young of Y.

- (1) A and D only
- (2) B and C only
- (3) B, C and D only
- (4) A, B and D only

4. The diagram shows the life cycle of a flowering plant.

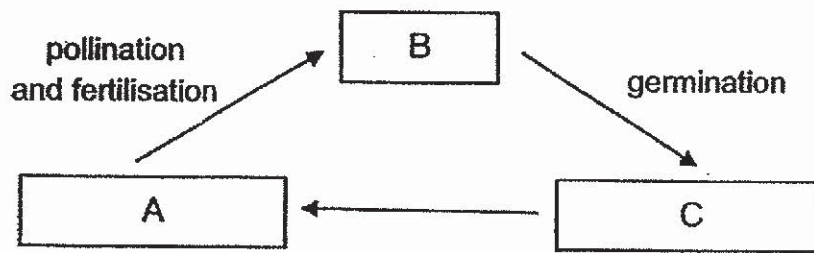

Which one of the following represents stages A, B and C correctly?

	A	B	C
(1)	adult plant	young plant	seed
(2)	young plant	seed	adult plant
(3)	seed	adult plant	young plant
(4)	adult plant	seed	young plant

5. Which of the following statements about heredity is/are true?

- A The offspring inherit traits from both parents.
- B A male parent cannot pass his traits to a female child.
- C The eye colour of an offspring is a trait that can be inherited from parents.

- (1) A only
- (2) A and C only
- (3) B and C only
- (4) A, B and C

6. The diagram below shows the cross-section of a flower.

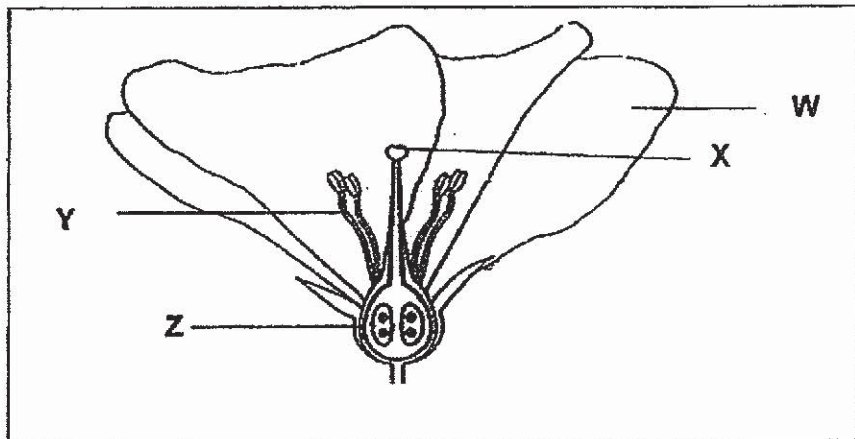

Four similar flowers, A, B, C and D, had some part(s) removed from them as shown in the table below. A cross (x) shows the part(s) removed.

Flower	Part(s) removed			
	W	X	Y	Z
A	x			
B			x	
C	x		x	
D		x		x

Which flowers are still able to develop into fruits?

- (1) A and B only
- (2) C and D only
- (3) A, B and C only
- (4) A, B, C and D

7. Amanda wanted to find out if the presence of roots affects the rate of water transported up the plants. She prepared two set-ups, X and Y, using similar plants of the same height as shown below. The roots of the plant in set-up Y has been removed.

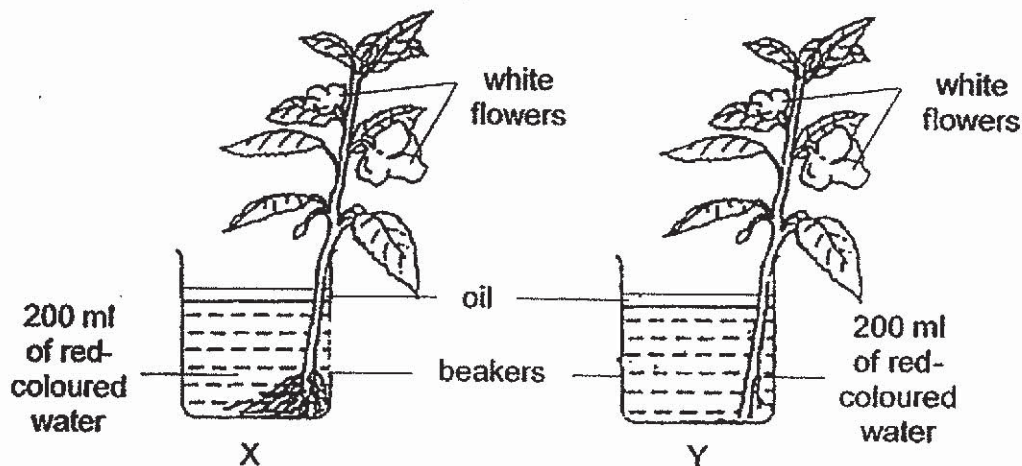

Which of the following observations would allow Amanda to draw conclusion for her experiment?

- A The height of growth of each plant after two hours.
- B The volume of water left in each beaker after two hours.
- C The time taken for both flowers in each in set-up to turn red.

- (1) B only
- (2) C only
- (3) A and C only
- (4) B and C only

8. The diagram below shows the human digestive system.

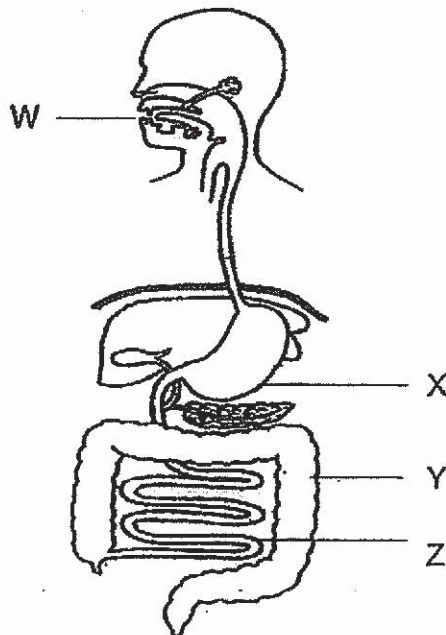

Which of the following statement(s) is/are correct?

- A Digestion ends at Z.
- B There is most digested food at Y.
- C There is more undigested food at W than at X.
- D Digestive juices are produced at X and Z only.

- (1) B only
- (2) A and C only
- (3) B and C only
- (4) A, B and D only

9. The table below shows the characteristics of cells from different organisms, X, Y and Z. A tick (✓) indicates the presence of the parts of a cell.

Parts of cell	Cells from Organisms		
	X	Y	Z
nucleus	✓	✓	✓
chloroplast			✓
cell wall	✓		✓
cell membrane	✓	✓	✓

Which one of the following statements is incorrect?

- (1) Organism Y could be an animal.
- (2) Organism Z is able to make food.
- (3) The cells of organisms Y and Z are taken from the same plant part.
- (4) The cells of organisms X, Y and Z allow certain types of substances to move in and out their cells.



10. Which one of the following graphs correctly shows how carbon dioxide affects the rate of photosynthesis ?

(1)

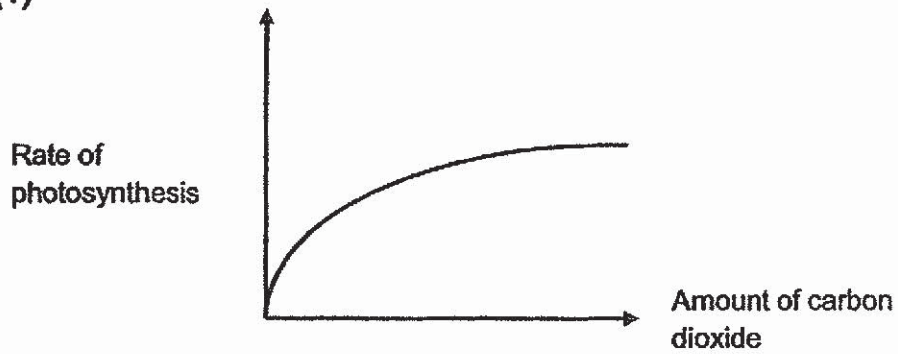

(2)

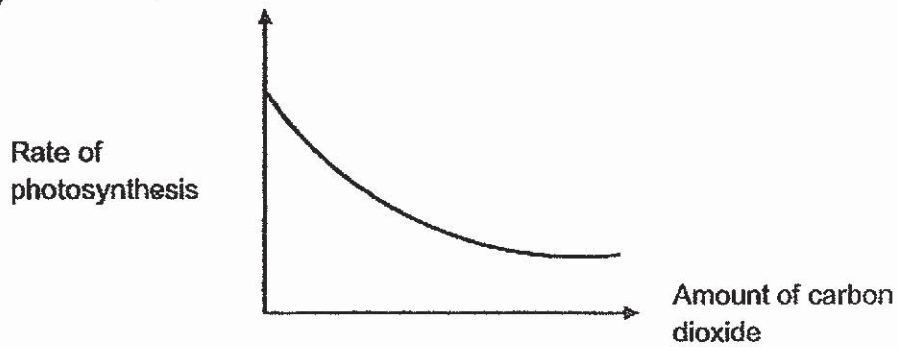

(3)

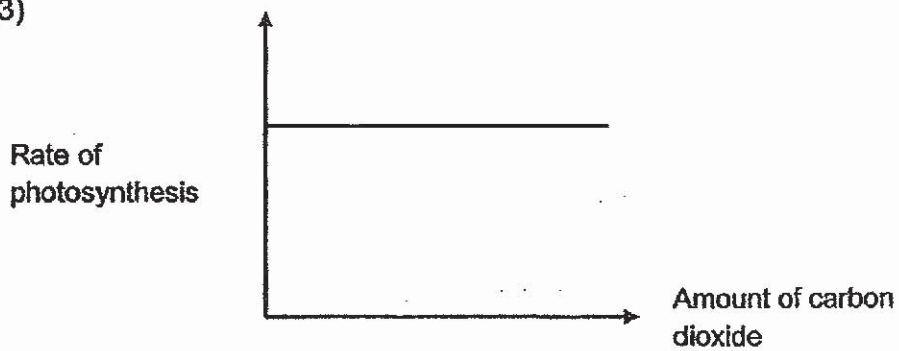

(4)

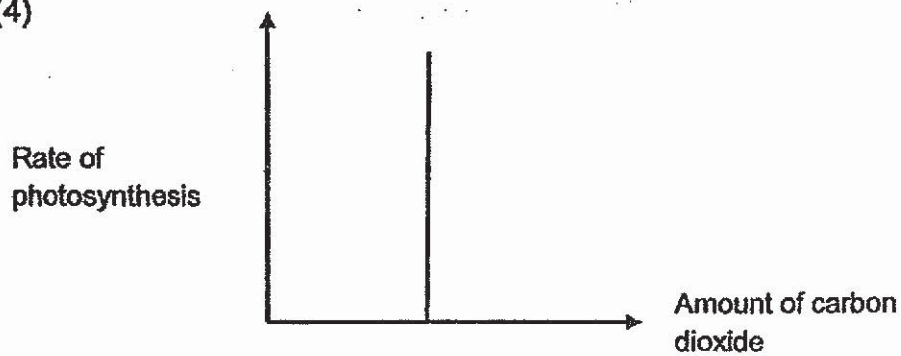

11. Some green plants were planted in the sealed glass bottle filled with moist and fertile soil. The glass bottle was placed near the window for one week.

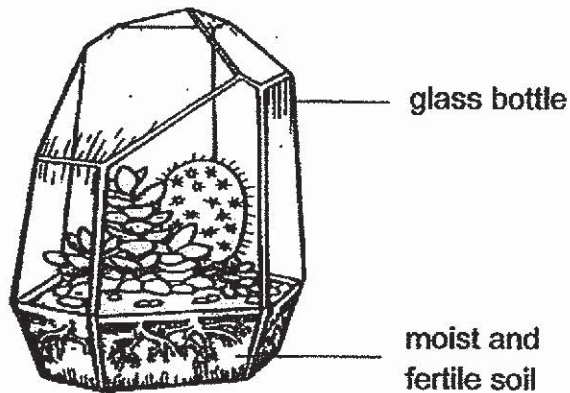

Which of the following statement(s) is/ are correct?

- A The plant would die three days later as there was no air.
- B The plants could only carry out photosynthesis but not respiration.
- C The plants survived as there was a constant supply of air and water.
- D The water in the soil would dry up and the plants would have no water.

- (1) B only
- (2) C only
- (3) A and C only
- (4) B and D only

12. The diagram shows a food web. Organisms P, Q, R and S are found in the same community.

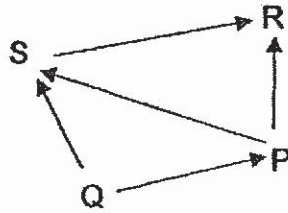

Which one of the following graphs correctly represents the number of organisms present in that community?

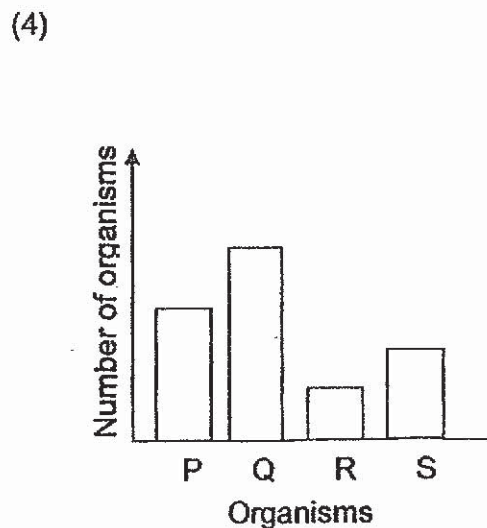
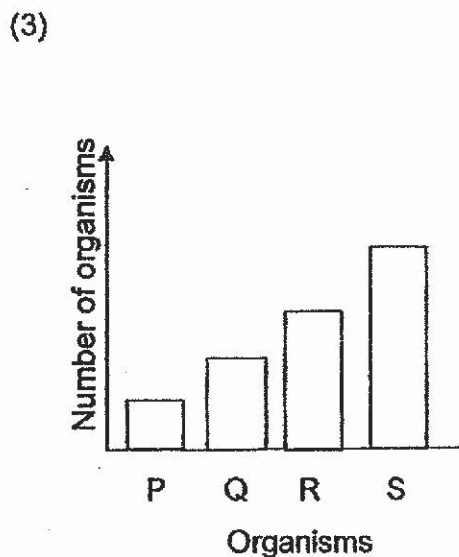
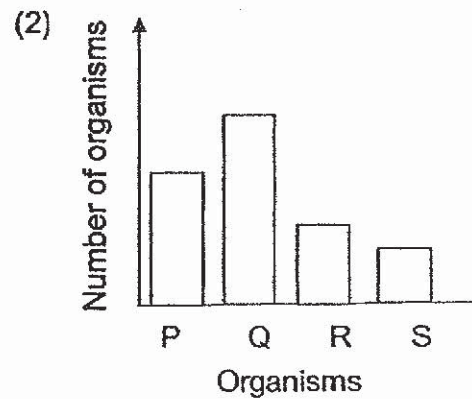
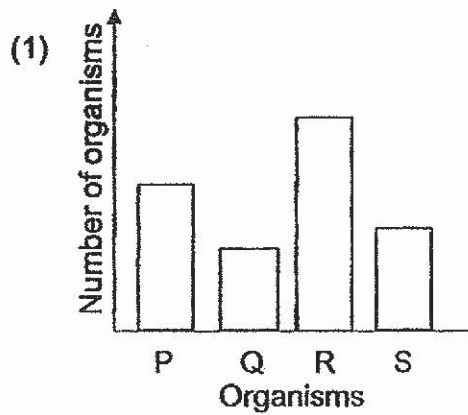

13. Study the following food web in a field.

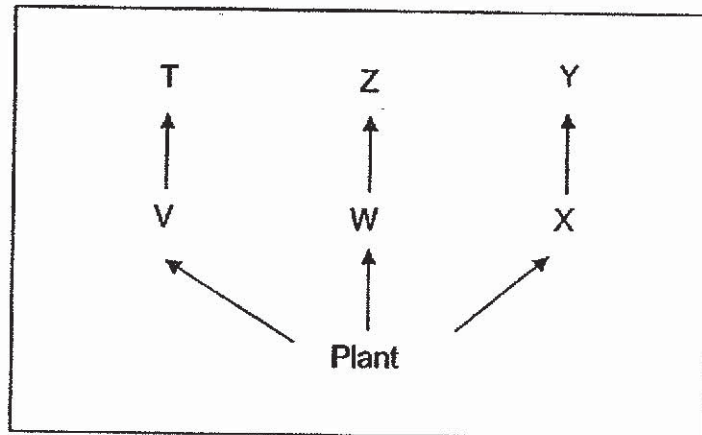

The use of pesticide in the field resulted in the death of most organism V and organism W only.

Which one of the following most likely shows the effect of pesticide on the population of organisms X and Z?

	Population size of organism X	Population size of organism Z
(1)	increases	remains the same
(2)	decreases	remains the same
(3)	decreases	increases
(4)	increases	decreases

14. Porcupines are very well adapted to live in the forest. They eat leaves, twigs, buds and even barks of trees.

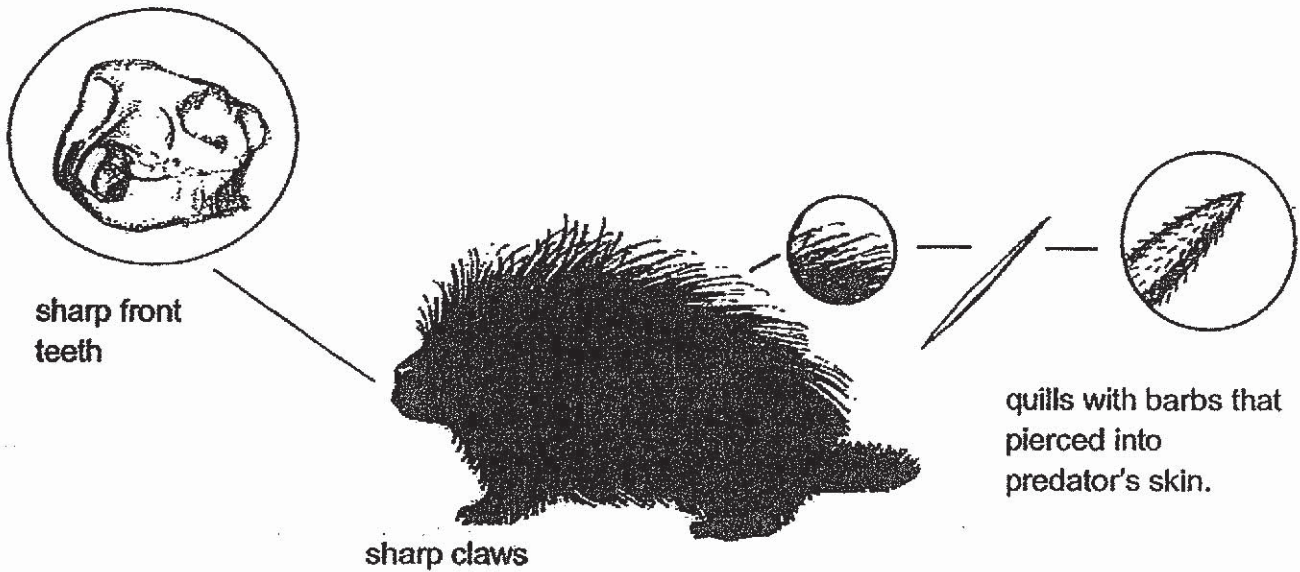

Which one of the following is a behavioural adaptation of the porcupine that enables it to survive well in the forest?

- (1) They have sharp claws for climbing trees.
- (2) They turn their backs and raise their quills in self-defense.
- (3) They have sharp front teeth that grow throughout their lives.
- (4) They have quills with barbs that can pierce into predator's skin.

15. The four graphs below show the changes in global sea levels over a period of time.

Which one of the following most likely shows the effect of continual deforestation activities on the sea level over time?

(1)

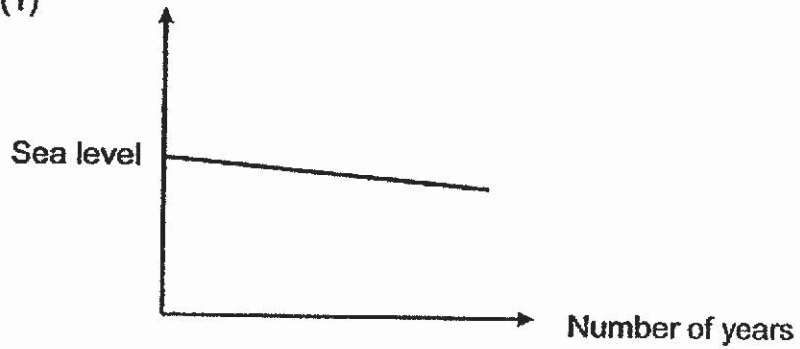

(2)

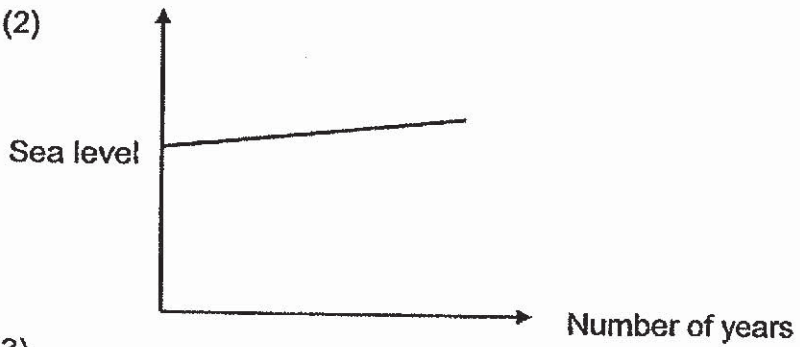

(3)

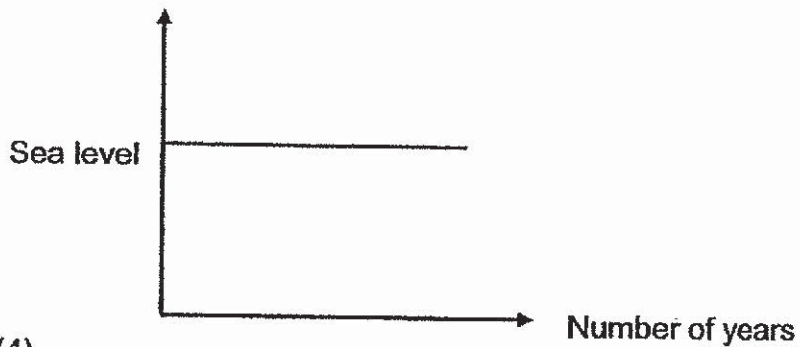

(4)

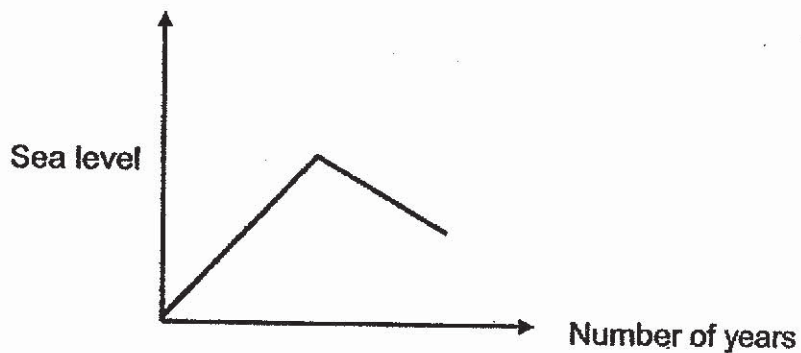

16. The table below shows how the amount of sugar produced by plants is affected by light intensity.

Light intensity (lux)	Amount of sugar produced (milligrams)			
	Plant E	Plant F	Plant G	Plant H
70	37	38	38	39
50	28	20	32	23
30	19	9	27	11
10	14	2	15	3

Which plants are suitable to be used as indoor plants?

- (1) Plants E and G
  - (2) Plants E and H
  - (3) Plants F and H
  - (4) Plants F and G
17. Chloe set up an experiment as shown below to compare four strips of different materials, J, K, L and M, which are of the same thickness.

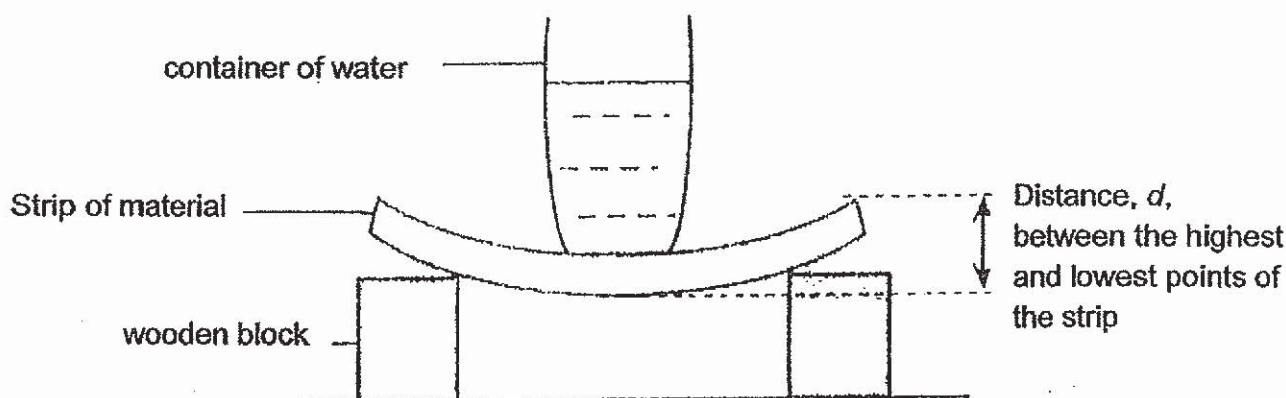

She placed a container containing  $100 \text{ cm}^3$  of water on each strip of material and she recorded the distance,  $d$ , as shown in the table below.

Materials	J	K	L	M
$d$ (mm)	38	55	5	42

Which materials are most suitable for making a food tray and a belt?

	Material for food tray	Material for belt
(1)	J	M
(2)	K	L
(3)	L	K
(4)	M	J

18. Jane set up the experiment below to find out about the properties of matter.

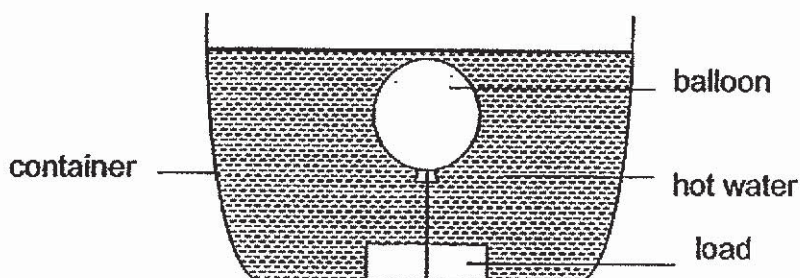

After some time, she observed both the size of the balloon and the water level in the container increased.

Which one of the following explains why the water level in the container increased?

- (1) The balloon expanded and increased in mass.
  - (2) The hot water expanded and occupied more space.
  - (3) The hot water increased in mass and occupied more space.
  - (4) The air in the balloon expanded and occupied more space in water.
19. The table below shows the melting and boiling points of two substances, P and Q.

Substance	Melting Point (°C)	Boiling point (°C)
P	55	230
Q	110	180

Which one of the following shows the correct properties of substances P and Q at 200 °C?

	Property of P	Property of Q
(1)	definite volume	definite shape
(2)	definite shape	definite volume
(3)	no definite volume	can be compressed
(4)	no definite shape	can be compressed



20. Two rooms, A and B, are separated by a glass window. Tiny water droplets are observed on the glass window in room A as shown below.

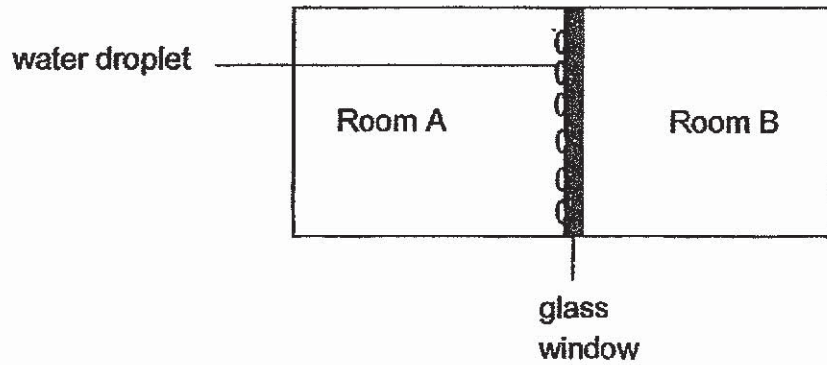

Based on the observation above, which one of the following shows the correct temperature in each room?

	Temperature of room A ( $^{\circ}\text{C}$ )	Temperature of room B ( $^{\circ}\text{C}$ )
(1)	15	40
(2)	40	5
(3)	40	40
(4)	5	15

21. The diagrams below show three circuit arrangements, A, B and C.

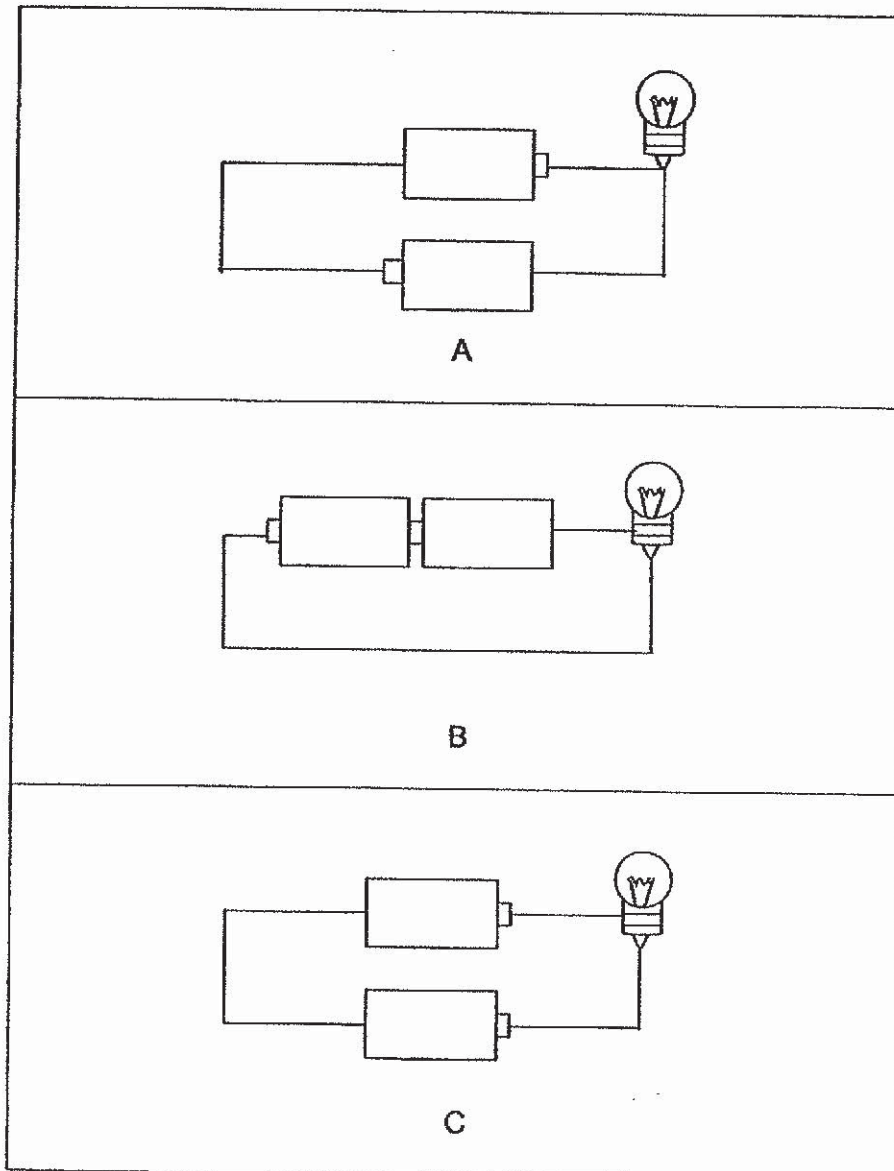

In which of the following arrangements would the bulb light up?

- (1) A only
- (2) B only
- (3) A and C only
- (4) B and C only

22. Five metal pins A, B, C, D and E were fixed onto a wooden board as shown in diagram 1 below. Diagram 2 shows a circuit connected to wires X and Y.

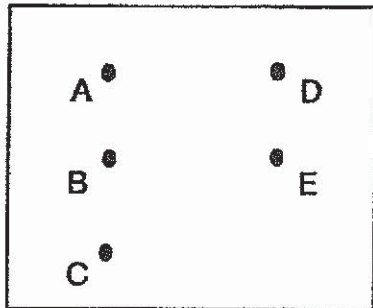

Diagram 1

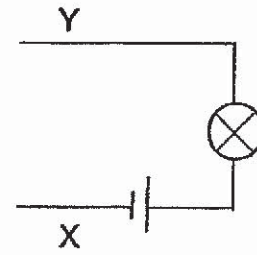
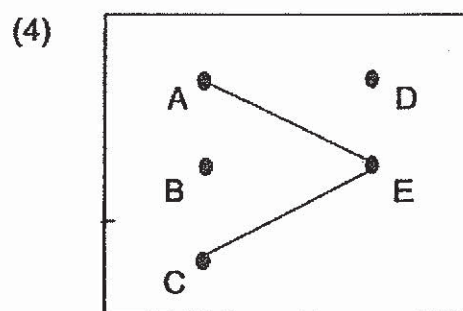
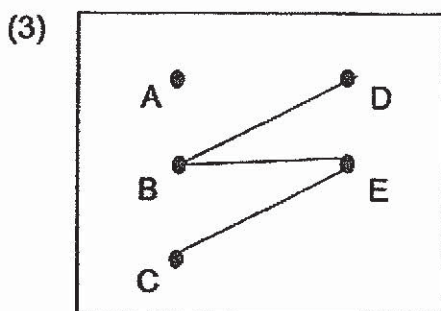
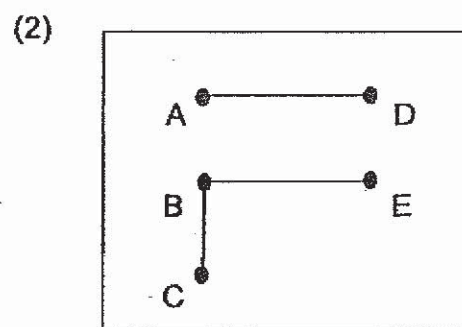
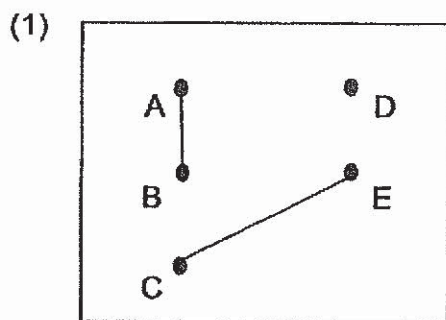

Diagram 2

Some of the pins in diagram 1 were connected with wires. Then Wires X and Y were connected to different pairs of pins. The results were recorded in the table below.

Pin connected to X	Pin connected to Y	Did the bulb light up?
A	B	No
A	C	Yes
B	D	No
D	E	No

Which of the following shows the correct arrangement of wires on the circuit card?



23. Clara prepared an experiment set-up with objects P, Q and R. She placed each object near a magnet, an iron nail and a plastic spoon and observe the interaction amongst them. Her observations were recorded in the table below.

Object	Observation		
	Magnet	Iron Nail	Plastic spoon
P	repel	attract	no interaction
Q	attract	no interaction	no interaction
R	no interaction	no interaction	no interaction

Based on Clara's observations, which of the following correctly represent objects P, Q and R?

	P	Q	R
(1)	copper bar	magnet	iron bar
(2)	magnet	copper bar	iron bar
(3)	magnet	iron bar	copper bar
(4)	iron bar	copper bar	magnet

24. A rectangular block has surfaces labelled F, G and H as shown in the diagram below. Surface F of the rectangular block was placed in contact with the wooden surface. Then the block was pulled back against the rubber band before it was released and slid across the wooden surface.

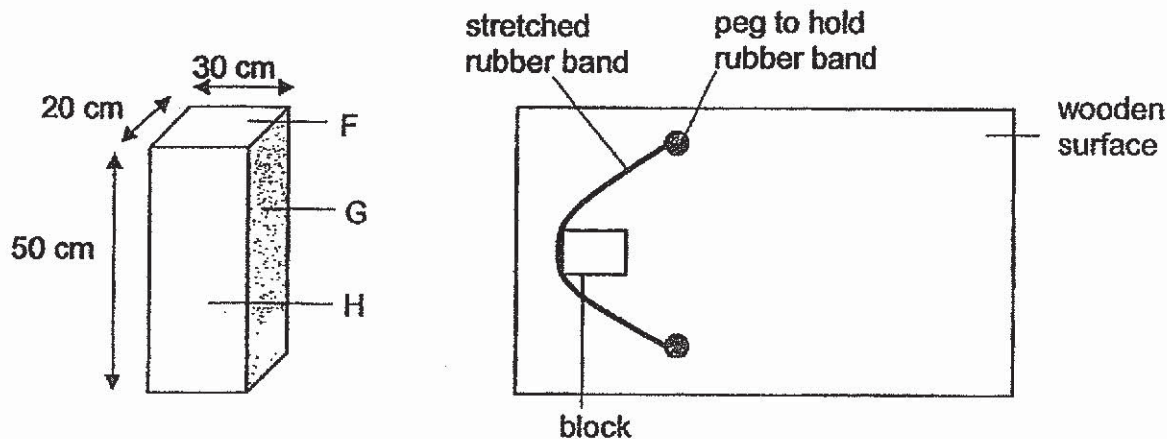

Rectangular block

Top view of set-up

The experiment was repeated with its two other surfaces, G and H, in contact with the wooden surface. The distance moved by the block was recorded as shown in the table below.

Surface	Area of contact with the wooden surface (cm <sup>2</sup> )	Distance moved by block on wooden surface (cm)
F	600	13
G	1000	13
H	1500	13

Based on the results of the experiment, which of the following statement(s) is / are true?

- A The distance moved by the block is not affected by the size of the contact area.
- B The gravitational force acting on the block is the greatest when it moved on surface H.
- C There is no frictional force between the block and the wooden surface as the block travelled the same distance.
- D Gravitational force and elastic spring force are the only forces acting on the wooden block as the block travelled on the wooden surface.

- (1) A only
- (2) B only
- (3) A and C only
- (4) A, B, C and D

25. Jason carried out an experiment using a balloon, string and iron straw as shown below. The string was passed through the iron straw and the balloon was then attached firmly to the iron straw with a magnet.

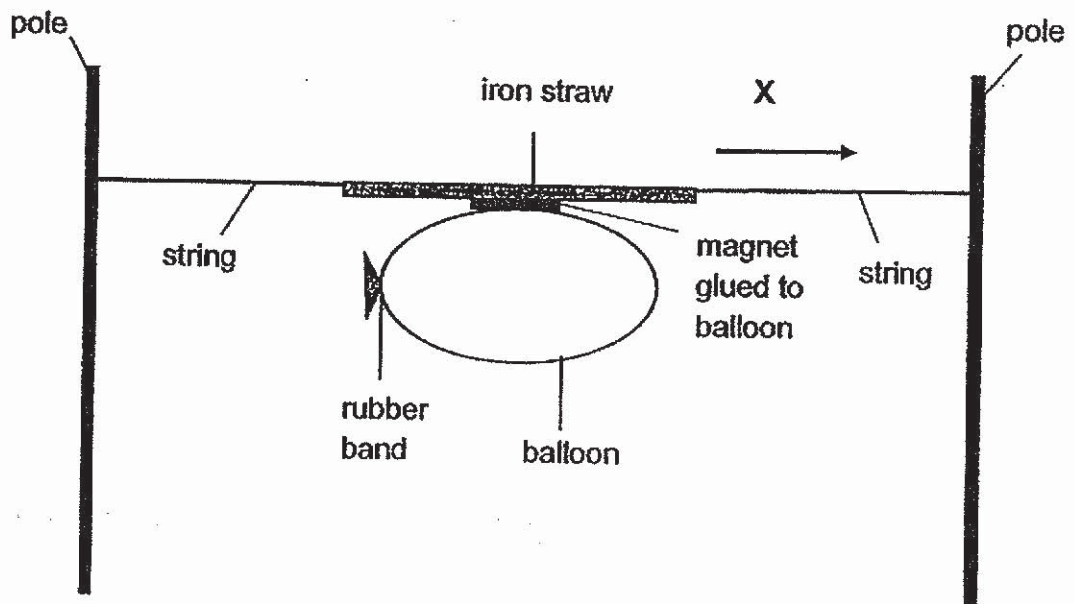

When the rubber band on the balloon was removed to release the air. The balloon and the iron straw moved in direction X.

Which of the following forces did the iron straw need to overcome when it was moving in direction X?

- A Frictional force
  - B Magnetic force
  - C Gravitational force
- 
- (1) A only
  - (2) B only
  - (3) A and C only
  - (4) A, B and C

26. In a dark enclosed room, four sheets, P, Q, R and S, were arranged in a straight line as shown below. When the candle was lit, a bright circular patch of light was observed only on sheet R.

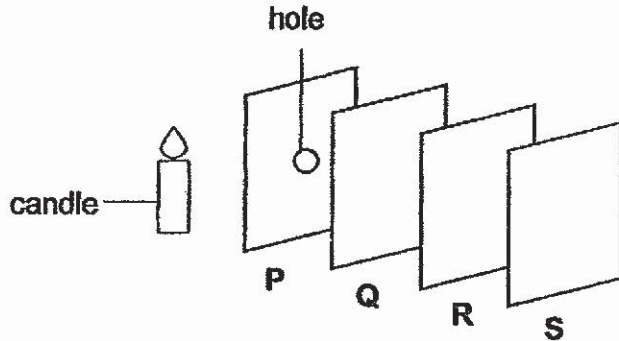

Based on the information above, which of the following statement(s) is/are definitely true?

- A Sheet S allowed some light to pass through it.
- B Sheets P and R did not allow any light to pass through it.
- C Sheet R allowed more light to pass through than sheet Q.

- (1) A only
- (2) B only
- (3) A and B only
- (4) B and C only

27. William conducted an experiment by heating three rods of identical length made of different metals, P, Q and R, for twenty minutes. He recorded the length of each rod before and after heating.

Metal	Length before heating (mm)	Length after heating (mm)
P	200	203
Q	200	212
R	200	208

William noticed there were gaps between train tracks, as shown below. He also observed that the gap was smaller on a hot day.

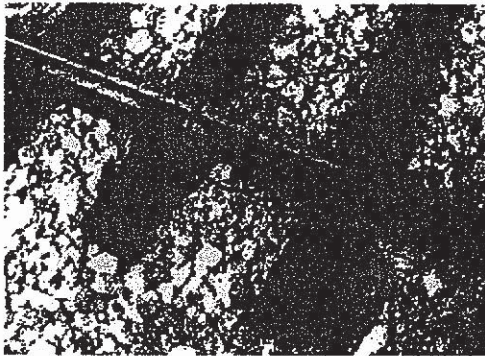

Gap between the train tracks

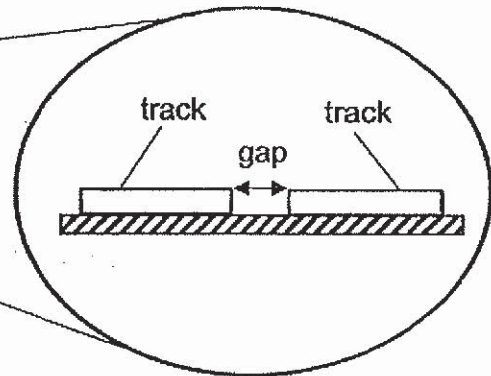

Magnified view of the gap

If metals P, Q and R were used to make the train tracks, which of the following choice of metals would result in the smallest and largest gaps between the tracks on a hot day?

	Smallest gap	Largest gap
(1)	P	R
(2)	Q	P
(3)	R	R
(4)	P	Q



28. The diagram below shows a girl diving into the water.

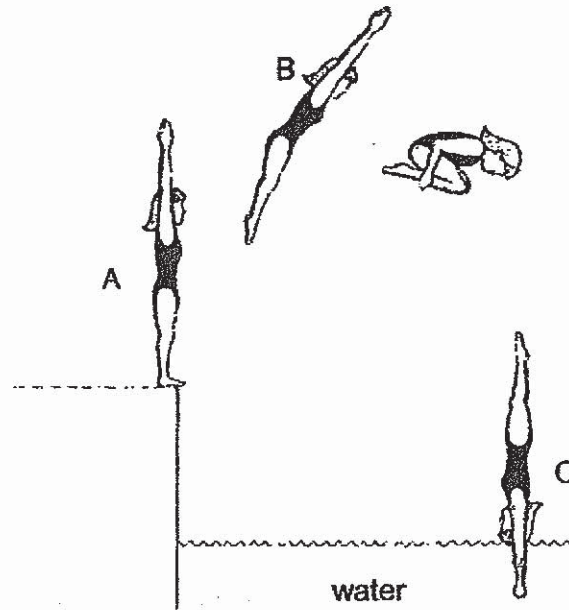

Which of the following shows how the amount of energy changes from A to B to C?

	Potential energy from A to B	Kinetic energy from B to C
(1)	decreases	decreases
(2)	decreases	increases
(3)	increases	decreases
(4)	increases	increases



Name : \_\_\_\_\_ Index No : \_\_\_\_\_ Class : P6 \_\_\_\_\_

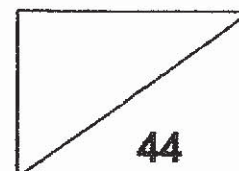

**SECTION B (44 marks)**

For questions 29 to 41, write your answers clearly in the spaces provided.

The number of marks available is shown in the brackets [ ] at the end of each question or part question.

29. Sam wanted to find out the conditions required for the growth of mould on fruit X. She placed fruit X in four identical sealed boxes, P, Q, R and S, exposed to different conditions as shown in the table below. A tick (✓) shows the presence of the condition.

Boxes	Conditions		
	Surrounding temperature (°C)	Presence of water	Presence of substance which absorbs water
P	35	✓	
Q	15	✓	
R	35		✓
S	15		✓

- (a) Sam observed that white mould started to appear on fruit X in box P. Give a reason for her observations. [1]

---

---

- (b) How did the mould appear since all boxes were sealed? [1]

---

---

Continue on next page

Score	
-------	--

*Continued from previous page*

One day, Sam was caught in the rain. When she reached home, she immediately kept her leather bag in the cupboard. A week later, she discovered some mould on the leather bag as shown below.

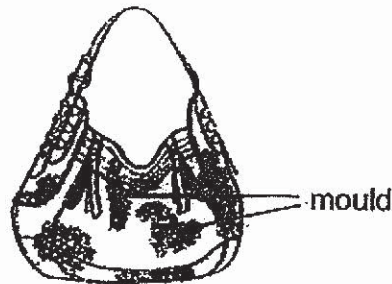

- (c) Sam's mother advised Sam to leave her wet bag under the Sun first before keeping it.

Explain how leaving the wet bag under the Sun helps to reduce the growth of mould. [1]

---

---

Score	1
-------	---

30. The diagram below shows two types of human reproductive cells, X and Y.

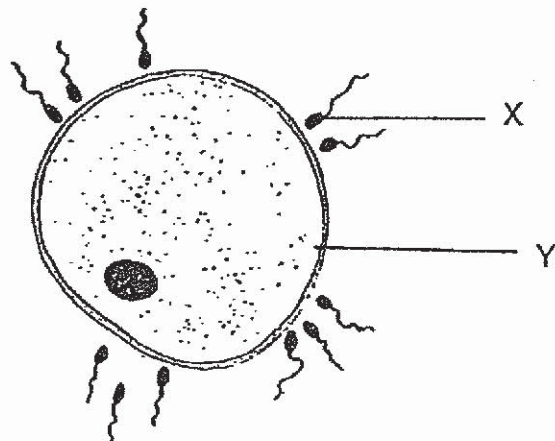

(a) Cell X is produced in large numbers. Give a reason for the observation. [1]

---



---

The diagrams below show the human reproductive systems.

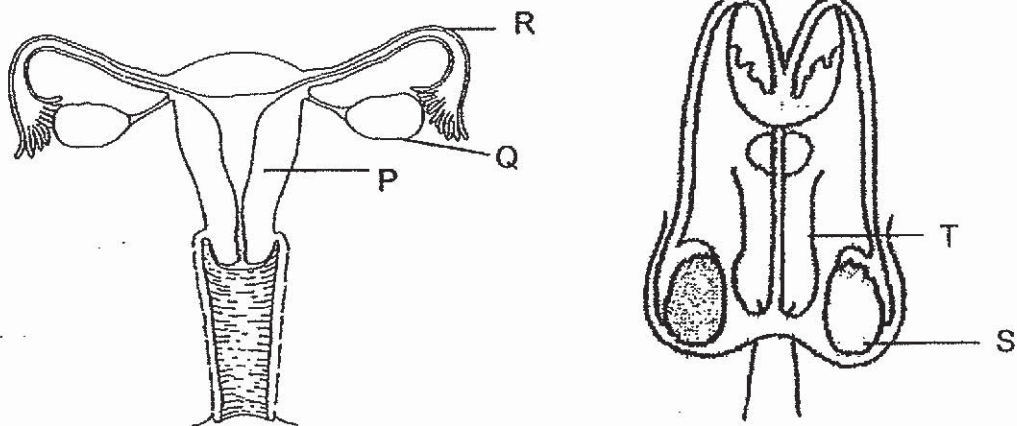

(b) Which parts, P, Q, R, S or T produce the following cells? [1]

(i) Cell X: \_\_\_\_\_

(ii) Cell Y: \_\_\_\_\_

Continue on next page

Score	2
-------	---

Continued from previous page

The diagrams below show two flowers, M and N, from the same type of plant.

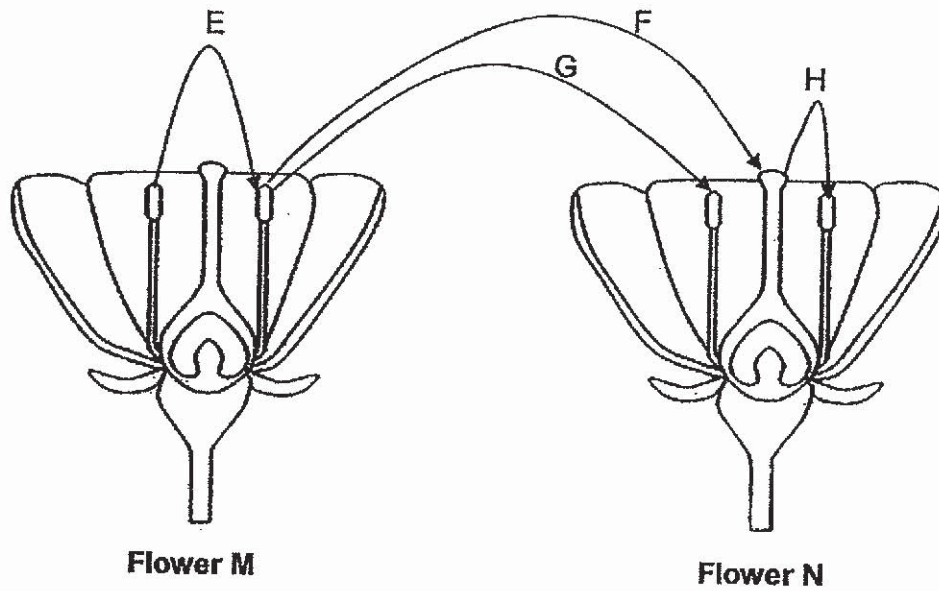

- (c) Identify the arrow(s), E, F, G and/or H, that represent(s) the process of pollination. [1]

---

---

- (d) State one characteristic of the flower that attracts animals to pollinate it. [1]

---

Score	
	2

31. Molly made a model of the human respiratory system using a cut bottle as shown below. A balloon was secured over the opening at the top and a rubber sheet was attached at the bottom of the bottle.

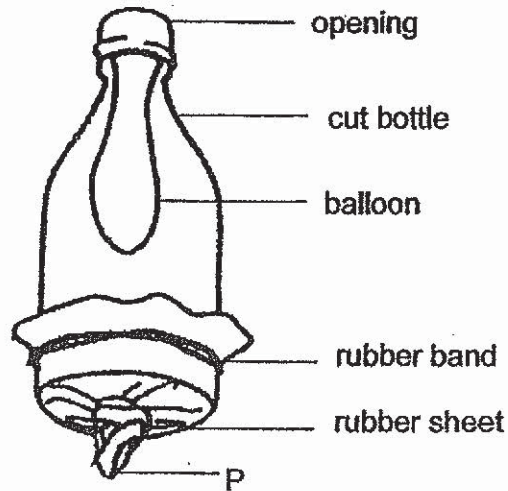

- (a) Which part of body do the following parts of the model represent? [1]

(i) balloon : \_\_\_\_\_

(ii) bottle : \_\_\_\_\_

- (b) What will happen to the balloon when part P of the rubber sheet was pulled downwards? [1]

---



---

- (c) State one difference between the composition of air entering the lungs and the air leaving the lungs in the human respiratory system. [1]

---



---

Score	3
-------	---

32. Melissa wanted to study the food relationships among organisms J, K, L and plant M. She kept different organisms in identical tanks which have sufficient air and water for one week. After one week, she recorded her results in the table below.

Tanks	Organisms kept together in the same tank	Number of Organisms	
		Start of Experiment	End of experiment
1	Plant M	30	5
	J	20	20
2	Plant M	30	30
	L	10	0
3	J	20	10
	K	10	10
4	Plant M	30	20
	K	10	5
	L	10	10

All animals L were found dead in tank 2 at the end of the experiment.

- (a) Based on the above information, complete the food web below.

[2]

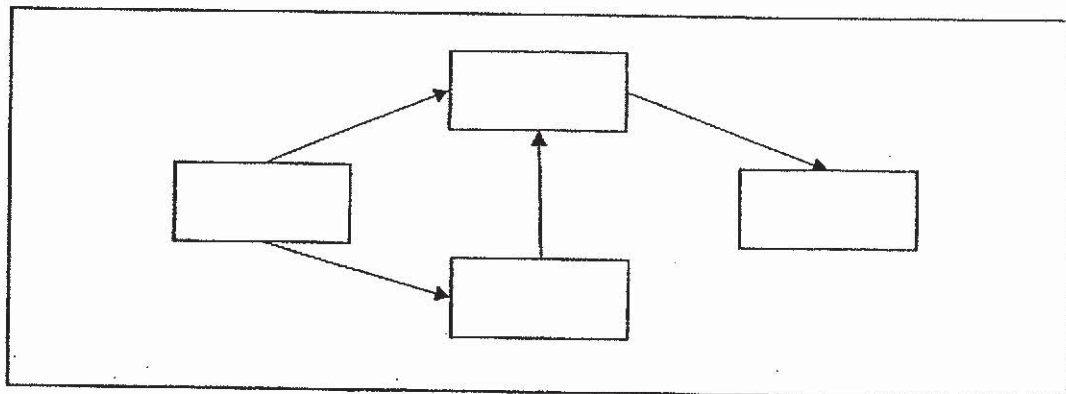

Continue on next page

Score	2
-------	---



Continued from previous page

The diagram below shows a habitat with some organisms.

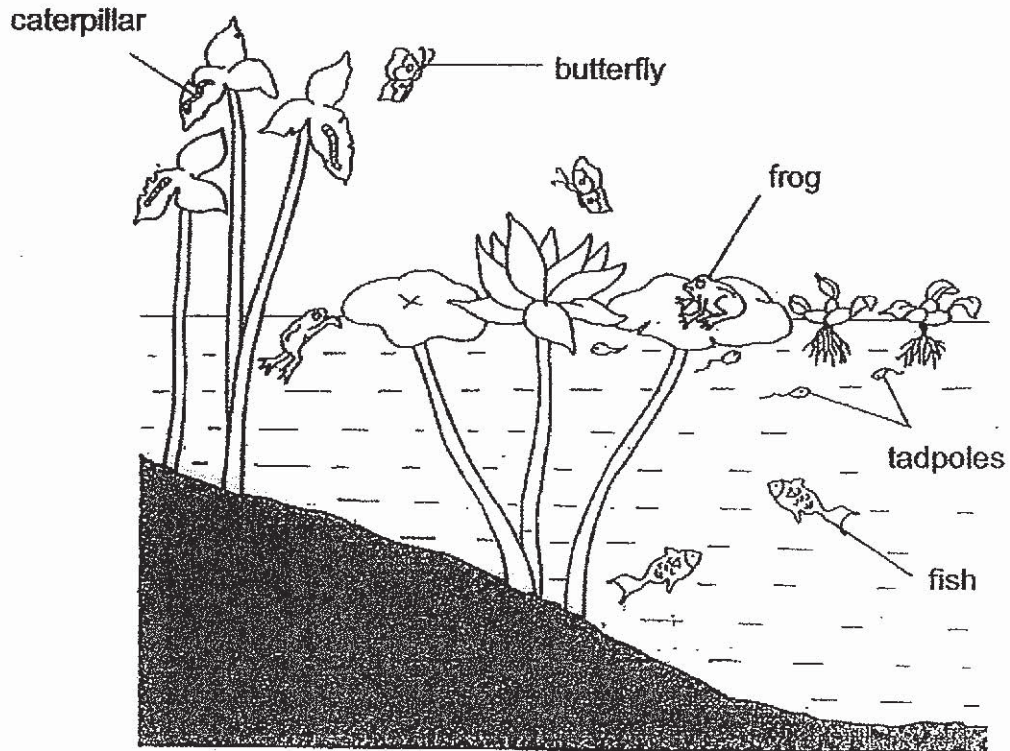

(b) Based on the diagram above, put a tick (✓) in the correct column on the table below to indicate if the statements are True or False. [2]

	Statements	True	False
(i)	There are five populations of animals.		
(ii)	There is one community with six populations.		
(iii)	There are more populations of consumers than populations of producers.		
(iv)	The groups of tadpoles, frogs, fish, caterpillars and butterflies form one community.		

Score	2
-------	---

33. Sophie heated identical objects, X and Y, to 80°C and then placed them in beakers A and B, as shown below. Both beakers were filled with the same amount of water at a temperature of 10°C.

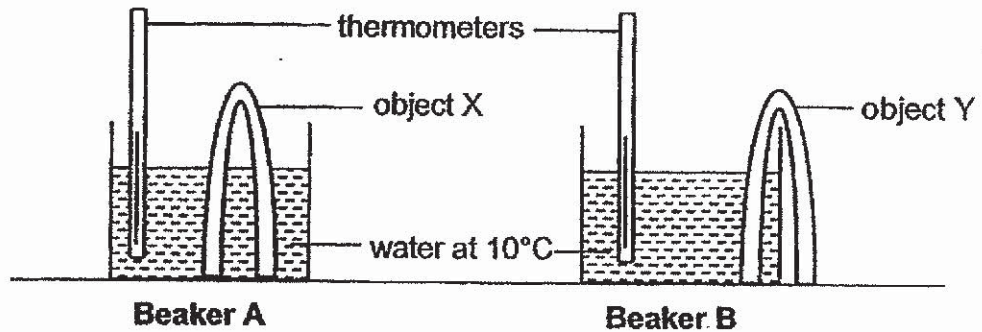

- (a) Sophie observed that the temperature of water in beaker A increased more quickly than that in beaker B. Explain Sophie's observation. [2]

---



---

The diagram below shows bird Z standing on one leg in water.

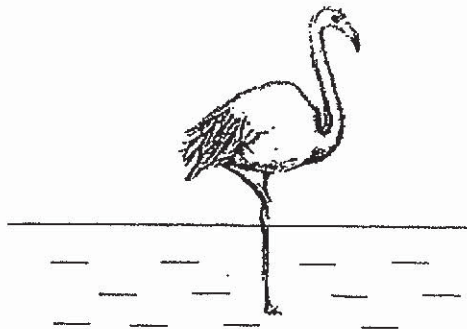

- (b) Explain how this adaptation benefits bird Z when the weather turns cold. [1]

---



---

Score	3
-------	---

34. The diagrams below show three waterproof containers, P, Q and R, made of different materials.

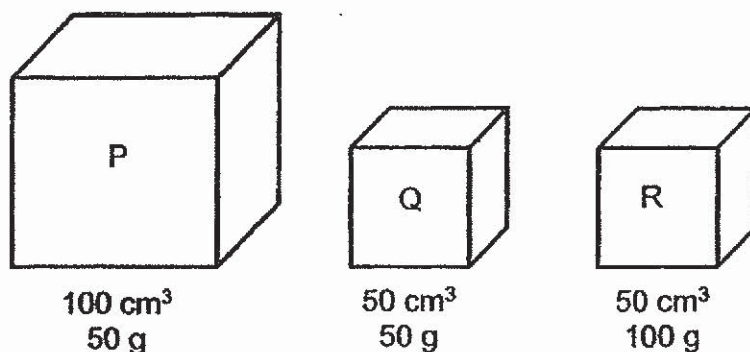

The diagram below shows a weighing balance.

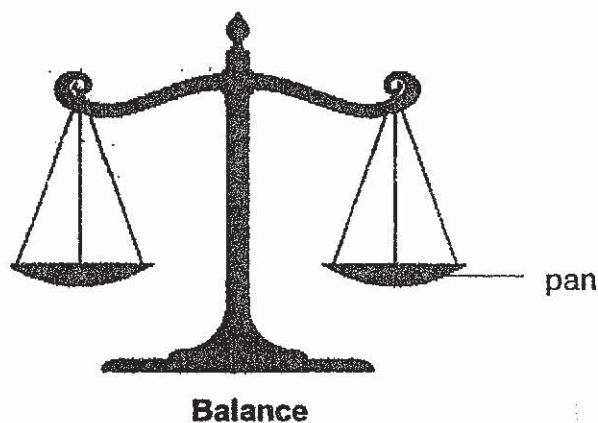

- (a) Which two containers, P, Q or R, should be placed on each pan on the weighing balance so that it remains balanced as shown in the above diagram? [1]

- (b) Give a reason for your answer in (a). [1]

Score	2
-------	---

Continued from previous page

The diagram below shows two cylinders, X and Y, containing marbles and water respectively.

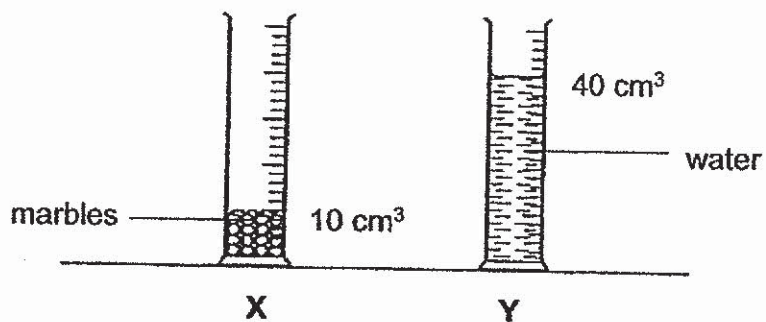

- (c) When all the marbles and water were poured into container P, it was less than half-filled. Explain this observation. [1]

---

---

Score	1
-------	---

35. Amin sprays himself with mist to cool himself on a hot day.

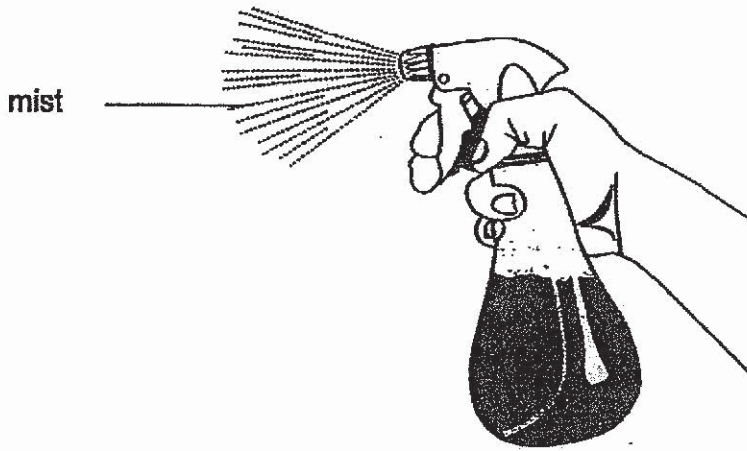

(a) Explain how spraying mist on himself helps him to cool down on a hot day. [1]

---

---

(b) Why does Amin feel colder when he is spraying mist on himself on a windy day? [1]

---

---

(c) After Amin stepped out from an air-conditioned bus, he found tiny water droplets on his spectacle lens. Explain how the water droplets were formed. [2]

---

---

Score	
	4

36. The diagram below shows a circuit. The table shows what happened to the light bulb when three different rods, P, Q and R, were connected one at a time to the contact points X and Y.

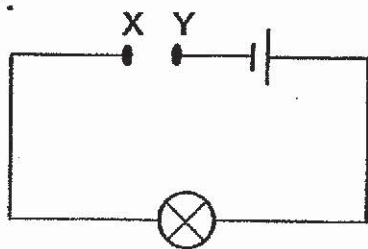

Rod that connects X and Y	Did the bulb light up?
P	Yes
Q	No
R	Yes

- (a) The diagram below shows another circuit with two bulbs. The same results were obtained when rods P, Q and R were used. The brightness of the each bulb remained the same for both circuits.

Based on the information above, draw wires in the circuit diagram below to show how the two bulbs were connected. [1]

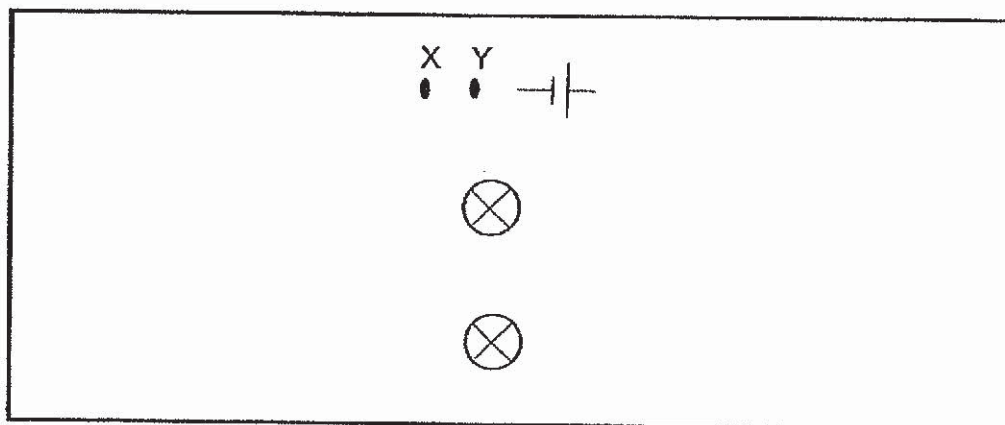

- (b) In another experiment, rods P, Q and R were placed at different positions in the circuit, as shown below.

Fill in the boxes below with the letters P, Q and R to show the correct positions of the rods such that only two bulbs will light up. [2]

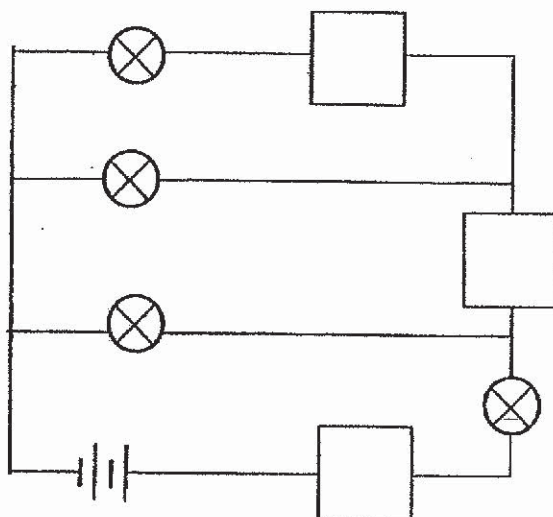

Score	3
-------	---

37. David attached Lego blocks Q and P to block L as shown in diagram below.

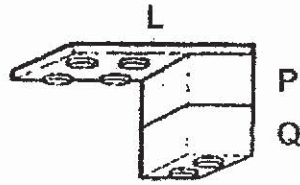

(a) Name the force that is acting on the blocks that enables them to be held together. [1]

David added another block R to Q and both blocks R and Q fell as shown below.

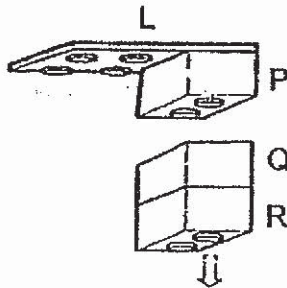

(b) Explain, in terms of forces, why the two blocks R and Q fell. [1]

(c) David wanted to separate block P from block L in the diagram below more easily.

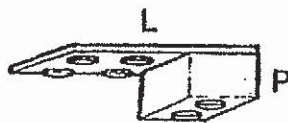

David's friend suggested that he should smear oil on all exposed surfaces of block P and then pull P away from L.

Do you agree with his friend's suggestion? Explain your answer. [1]

Score	3
-------	---

38. Melvin conducted an experiment using four springs, P, Q, R and S, of equal length.

He hung a metal rod M from two of the springs at an equal distance, X cm, apart. The results of his experiment are shown below.

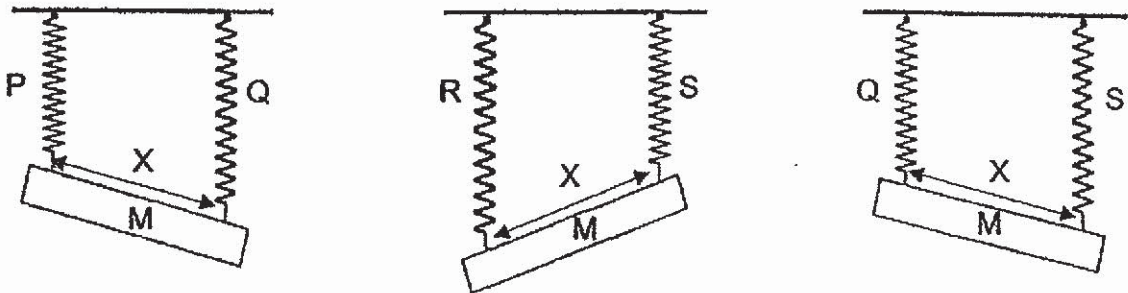

(a) Based on the results of the experiment, fill in the boxes with P, Q, R and S, next to the lines on the graph below that best represent the respective springs. [2]

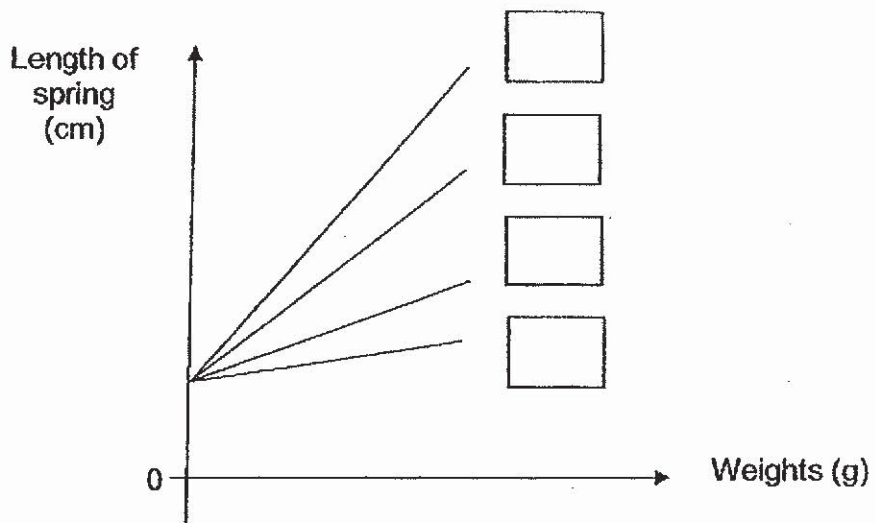

Continue on next page

Score	2
-------	---



Continued from previous page

In another experiment, Melvin used the set-up below to compare the mass of two pears which are of similar size.

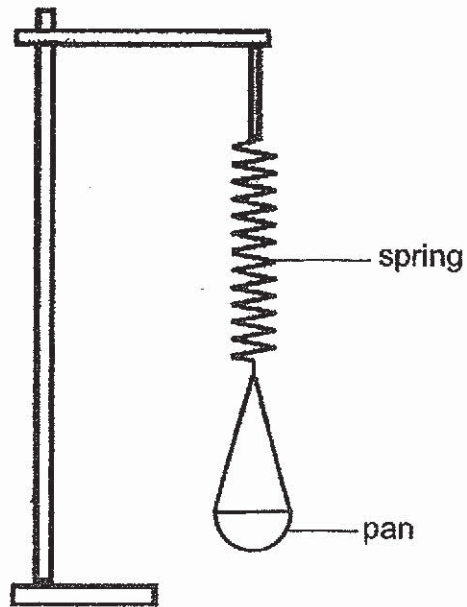

- (b) His mother suggested that spring R is the most suitable to be used for his set-up. Give a reason for her suggestion. [1]

---

---

Score	1
-------	---

39. The diagram below shows an experiment set-up using a torch and three wooden sticks, P, Q and R. The length of the shadow cast by each stick on the floor was measured.

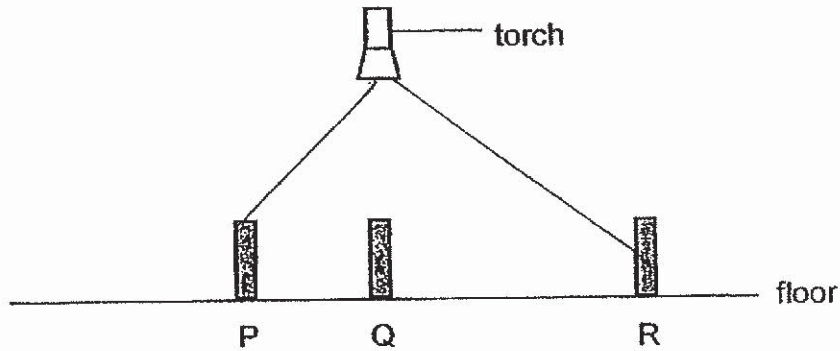

- (a) Two properties of light cause shadows to be formed. One of these properties is light is blocked by opaque objects. State the other property of light. [1]

---



---

- (b) Arrange the length of the shadow cast by sticks P, Q and R, starting with the longest shadow. [1]

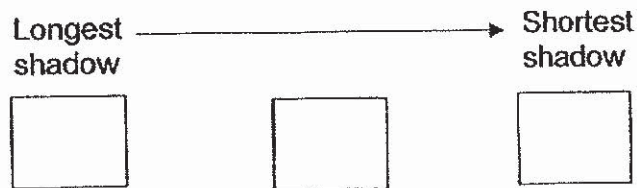

- (c) Using wooden stick P and without changing its position, suggest one way to increase the length of the shadow cast by it. [1]

---



---

Score	3
-------	---

40. The diagrams below show two identical ice cubes placed on blocks X and Y at room temperature. Blocks X and Y are made of different materials.

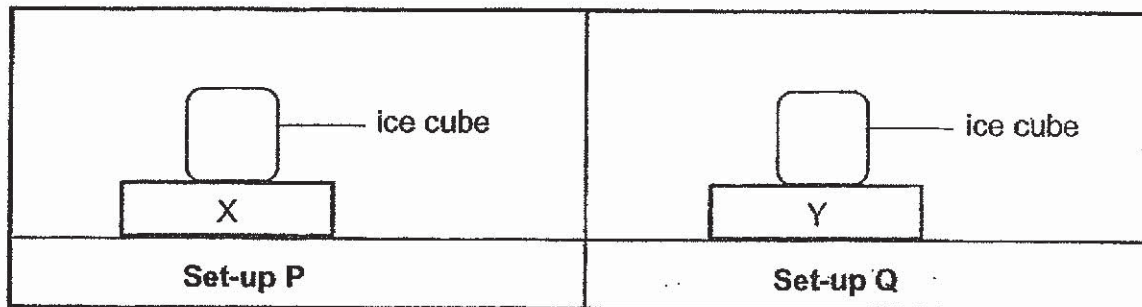

- (a) It was observed that the ice cube on block X took a shorter time to melt completely than that on block Y.

- (i) Based on the results above, what can be concluded about the property of X and Y? [1]

---

- (ii) Explain your answer in (a)(i). [1]

---



---

- (b) The mass of each ice cube was recorded over a period of time. The results are shown below.

Fill in the boxes with P and Q to show the correct results for each set-up. [1]

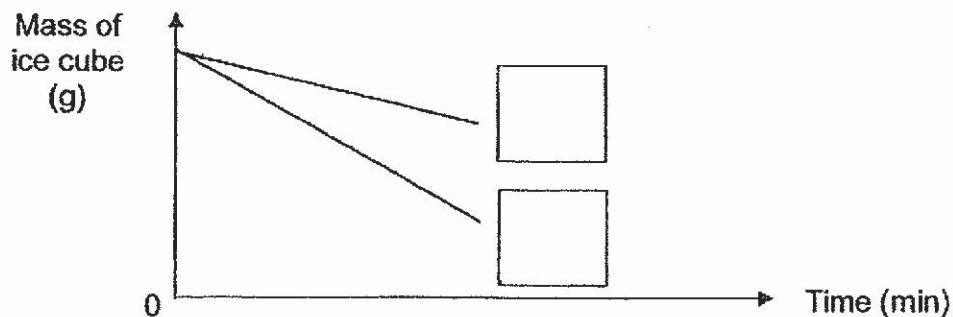

Score	3
-------	---

41. Jenny hung four balls, P, Q, R and S, above identical bells as shown below. The mass of balls P and R, was 100g each and the mass of balls Q and S was 200g each.

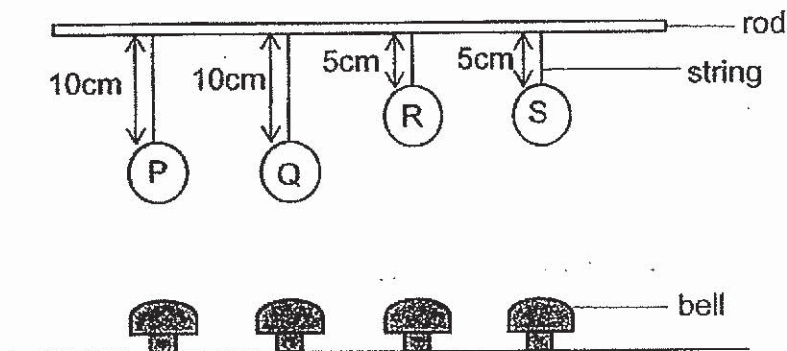

When each string was cut, the ball dropped and hit the bell below it.

- (a) Fill in the boxes below to show the main energy conversion when the string was cut. [1]

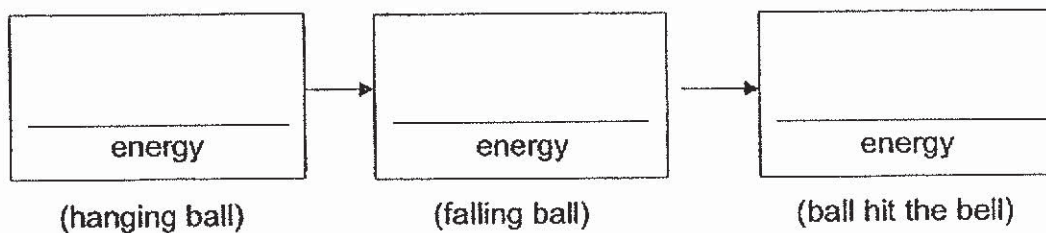

- (b) Which ball, P, Q, R or S, would produce the loudest and softest sound when it hit the bell? [1]

(i) Loudest sound : Ball \_\_\_\_\_

(ii) Softest sound : Ball \_\_\_\_\_

- (c) Explain your answer for (b)(i). [2]

---



---

- (d) Jenny wanted to find out if the height of the ball will affect the loudness of the bell. Which two balls should she use? [1]

---

- END OF PAPER -

Score	/
	5



**SCHOOL : RAFFLES GIRLS' PRIMARY SCHOOL**  
**LEVEL : PRIMARY 6**  
**SUBJECT : SCIENCE**  
**TERM : 2019 PRELIM**

**SECTION A**

Q 1	Q2	Q3	Q4	Q5	Q6	Q7	Q8	Q9	Q10
1	4	2	4	2	3	4	2	3	1
Q 11	Q12	Q13	Q14	Q15	Q16	Q17	Q18	Q19	Q20
2	4	4	2	2	1	3	4	4	2
Q 21	Q22	Q23	Q24	Q25	Q26	Q27	Q28		
2	4	3	1	1	2	2	4		

**SECTION B**

Q29)	<p>a) In Box P, there was the presence of water making the environment moist and the surrounding temperature is at 35°C which would provide warmth and allow mould to grow.</p> <p>b) Spores of fungi were already present in the box before sealing the box.</p> <p>c) The heat from the sun would dry up her bag from all the moisture.</p>
Q30)	<p>a) To increase the chance of at least one sperm fertilizing the egg.</p> <p>b) (i) S</p> <p>(ii) P</p> <p>c)</p> <p>d) large petals</p>
Q31)	<p>a) (i) lungs</p> <p>(ii) Rib-cage</p> <p>b) The balloon will inflate.</p>

	<p>c) Inhaled air has more oxygen, less carbon dioxide, less moisture and more dust than air leaving the lungs.</p>
Q32)	<p>a)</p> <pre> graph TD     M[Plant M] --&gt; K[K]     M --&gt; J[J]     J --&gt; K     K --&gt; L[L]   </pre> <p>b) (i) False (ii) True (iii) False (iv) False</p>
Q33)	<p>a) There is more contact surface area of X with water, more heat is conducted from X to the water faster.</p> <p>b) Less contact surface area of the body with the water, hence the body loss heat to the water slower.</p>
Q34)	<p>a) P and Q</p> <p>b) Both of the containers have the same mass of 50g.</p> <p>c) The water occupies the spaces in between the marbles and displaces the air.</p>
Q35)	<p>a) The mist contains tiny water droplets, his body would lose heat to the mist and evaporate to form water vapour, reducing the amount of heat in his body. Water droplets gain heat from the body to evaporate.</p> <p>b) The mist on Amin would gain heat from his body at a faster rate from the cooler surrounding, due to the wind and evaporate to form water vapour hence more heat is removed from his body.</p> <p>c) The water vapour in the surrounding air came into contact with the cooler surface of Amin's spectacle lens, lost heat and condensed to form tiny water droplets on his spectacle lens.</p>

Q36)

a)

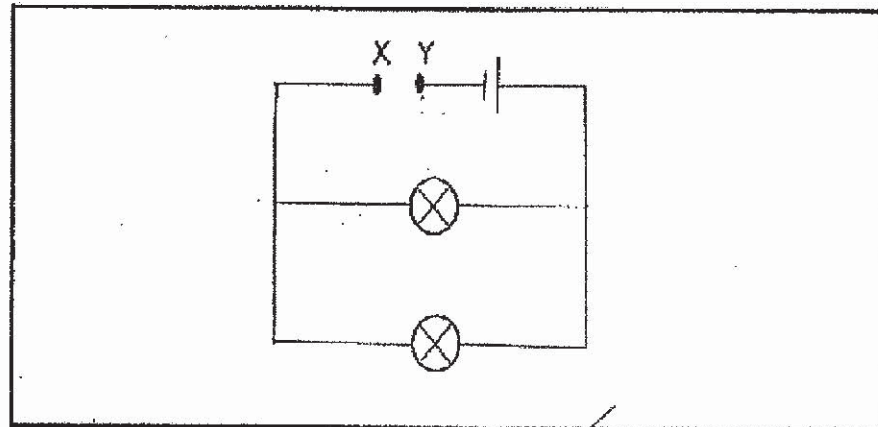

b)

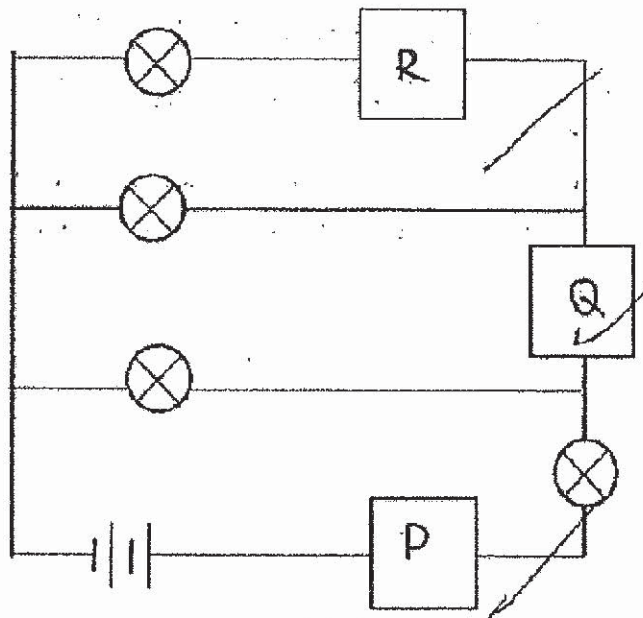

Q37)

a) Frictional force.

b) The gravitational force pulling the two blocks down is greater than the normal force acting between blocks P and Q.

c) Normal force is less than the frictional force between his hands and the block. He cannot have a good grip on it.

Q38)

a)

S  
Q  
P



	<p>b) Spring R. It extends the most when the same weight is hung on the springs.</p>
Q39)	<p>a) Light travels in a straight line.  b) R – P – Q  c) Move the torch further from P to the right.</p>
Q40)	<p>a) (i) X is a better conductor of heat than Y.  (ii) X conduct heat from the surrounding to the ice faster.  b) Q  P</p>
Q41)	<p>a) Gravitational potential – kinetic – sound  b) (i) S  (ii) P  c) It has the most gravitational potential energy which could be converted to kinetic energy and then to most sound energy.  d) Q and S</p>

