

**RAFFLES GIRLS' PRIMARY SCHOOL  
WEIGHTED ASSESSMENT 1  
PRIMARY SIX  
2023**

**SCIENCE**

Name: \_\_\_\_\_ ( )

Date : 21 February 2023

Class: P6 \_\_\_\_\_

Total Time: 50min

**INSTRUCTIONS**

1. Write your name, class and index number in the spaces provided above.
2. Do not turn over this page until you are told to do so.
3. Follow all instructions carefully.
4. Answer all questions.
5. For questions 1 to 8, write your answers clearly in the spaces provided.
6. The number of marks is shown in brackets [ ] at the end of each question or part question.

Your score out of 30	
Parent's signature	

1. The diagrams show the direction of blood flow in some parts of the human and fish bodies.

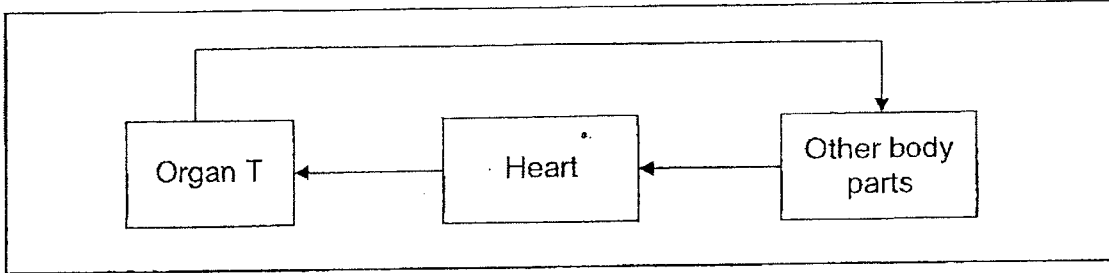

Circulatory system of a fish

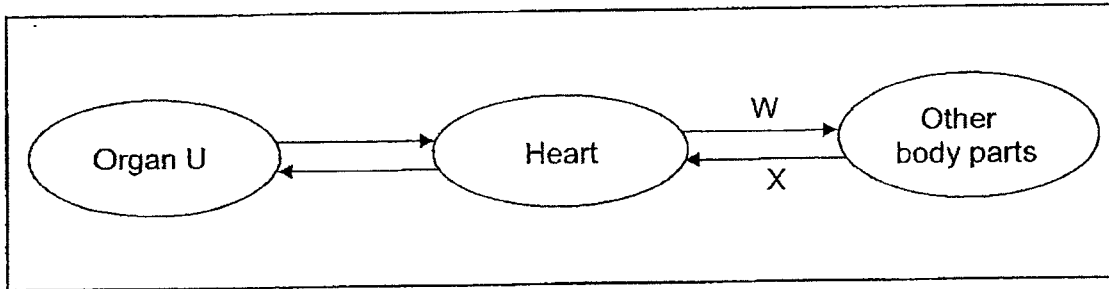

Circulatory system of a human

Based on the diagrams, answer the following questions.

- (a) Identify organs T and U. [2]

Organ T: \_\_\_\_\_

Organ U: \_\_\_\_\_

- (b) Name one substance in the blood where its amount is higher in W than X. [1]

\_\_\_\_\_

Score	3
-------	---

2. Ahmad prepared two set-ups, Y and Z, as shown in the diagram. He used two similar pots of plants watered with same amount of water. He put one pot of plant in a clear jar while the other pot of plant in an opaque jar. He placed them in the open field from 7a.m to 12a.m.

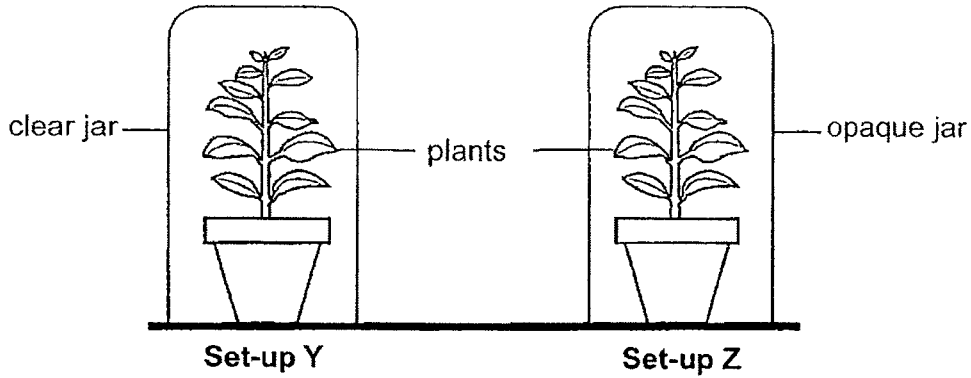

- (a) The graph shows the change in the amount of gases in **set-up Y** during the experiment. Label the gases in the boxes provided. [2]

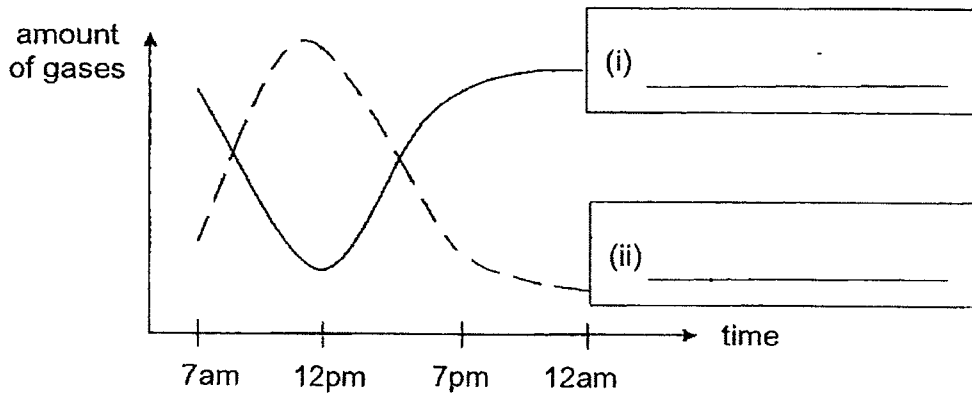

- (b) How would the amount of oxygen in **set-up Z** change from the start to the end of the experiment? Explain your answer. [2]

---



---

Score	4
-------	---

3. Betty prepared set-ups A and B as shown to find out if the amount of carbon dioxide affects the rate of photosynthesis.

When baking soda was mixed in water, it released carbon dioxide.

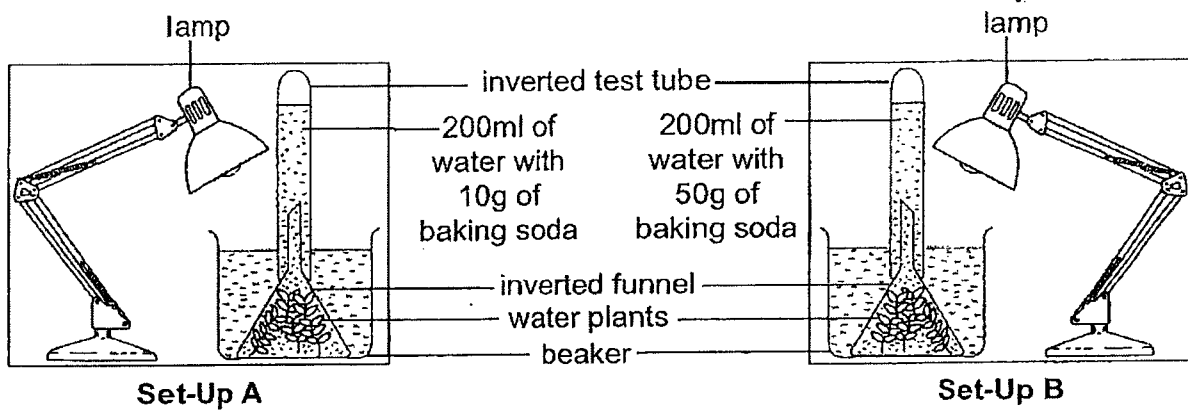

- (a) What result should she collect to measure the rate of photosynthesis? [1]

\_\_\_\_\_

- (b) State two variables that must be kept the same to ensure a fair test. [2]

(i) \_\_\_\_\_

(ii) \_\_\_\_\_

Continue on page 4

Score	3
-------	---

Continued from page 3

- (c) Based on the results she obtained, she plotted the graphs as shown. Label the graphs, **set-up A** and **set-up B**, to show which one represents the results for set-up A and set-up B. [1]

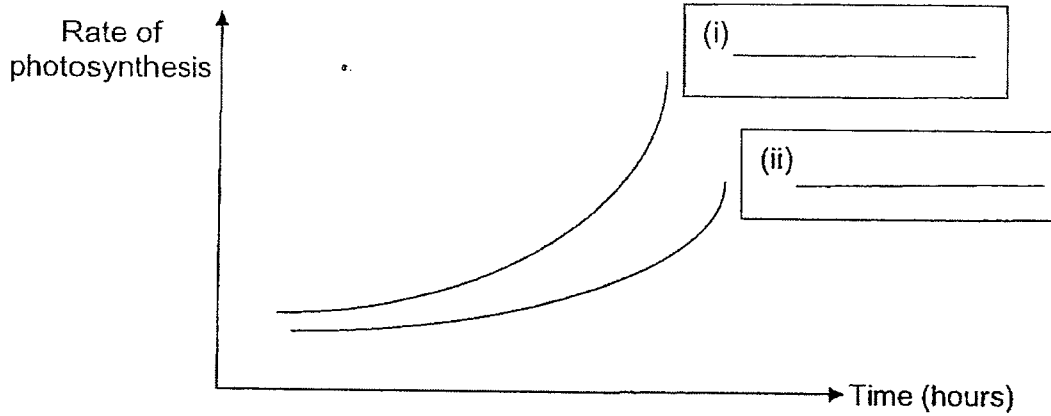

Her teacher told her that her experiment could be further improved by adding a control set-up as shown in the diagram.

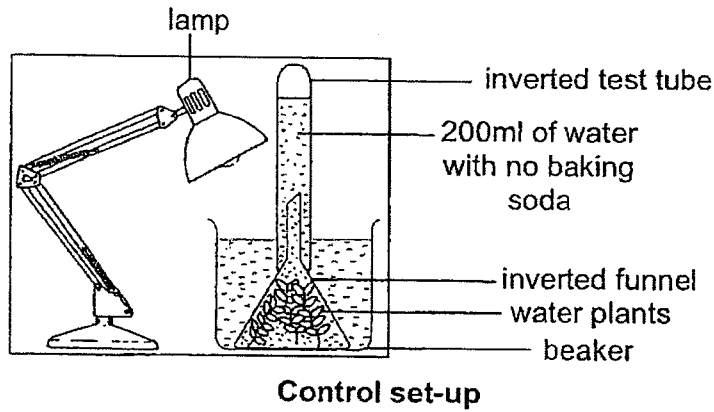

- (d) State the purpose of the control set-up. [1]

---



---

Score	1 / 2
-------	-------

4. Bala heated some water at 20°C. At the tenth minute, the water started to boil.

(a) State what boiling means. [1]

---

(b) In the diagram, draw the graph to show the change in temperature of water over twelve minutes. [1]

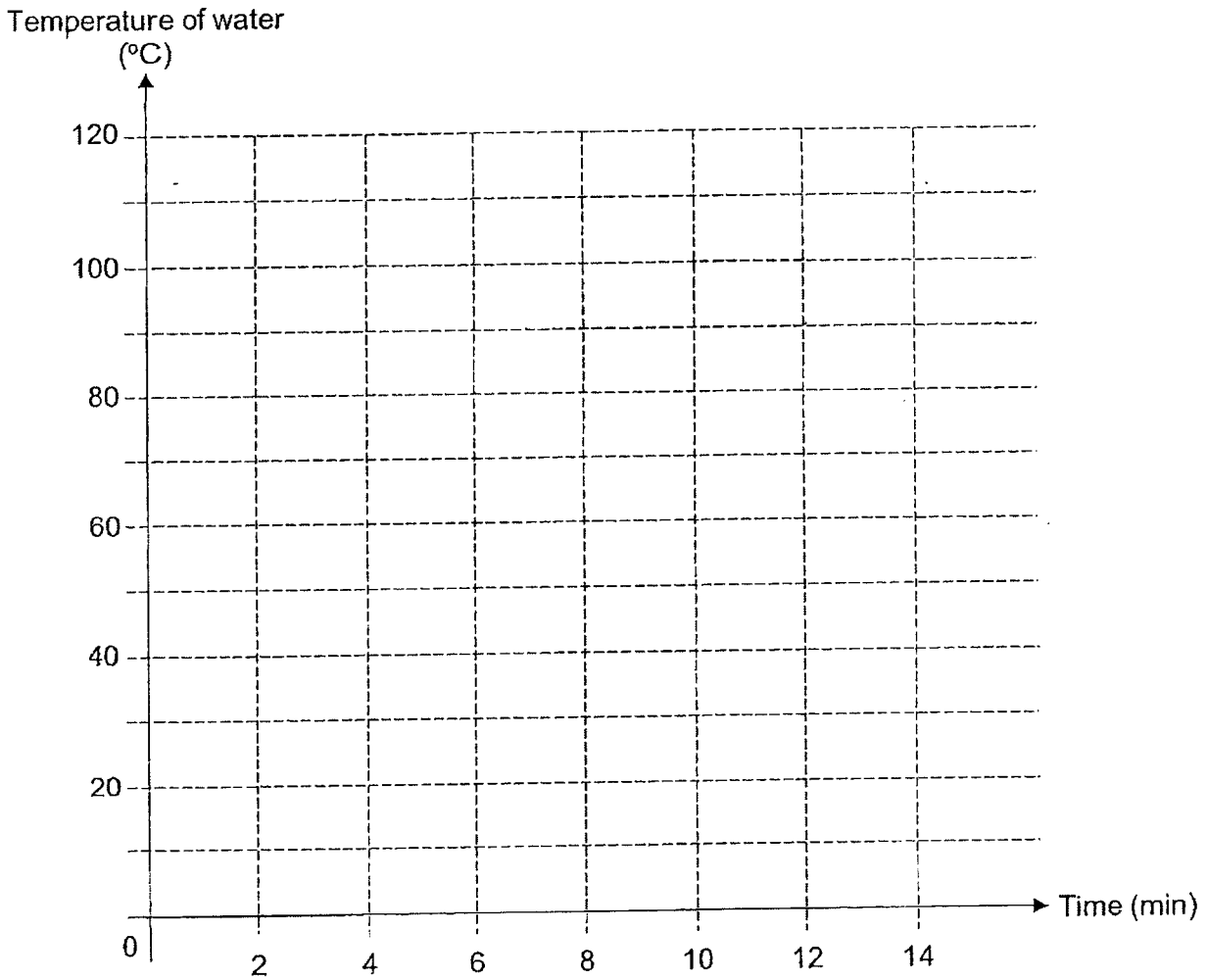

(c) State the change in state of water at the tenth minute. [1]

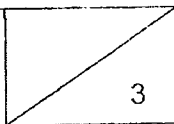
Score	
-------	---

5. The diagram shows a device that is used to collect clear water from muddy water.

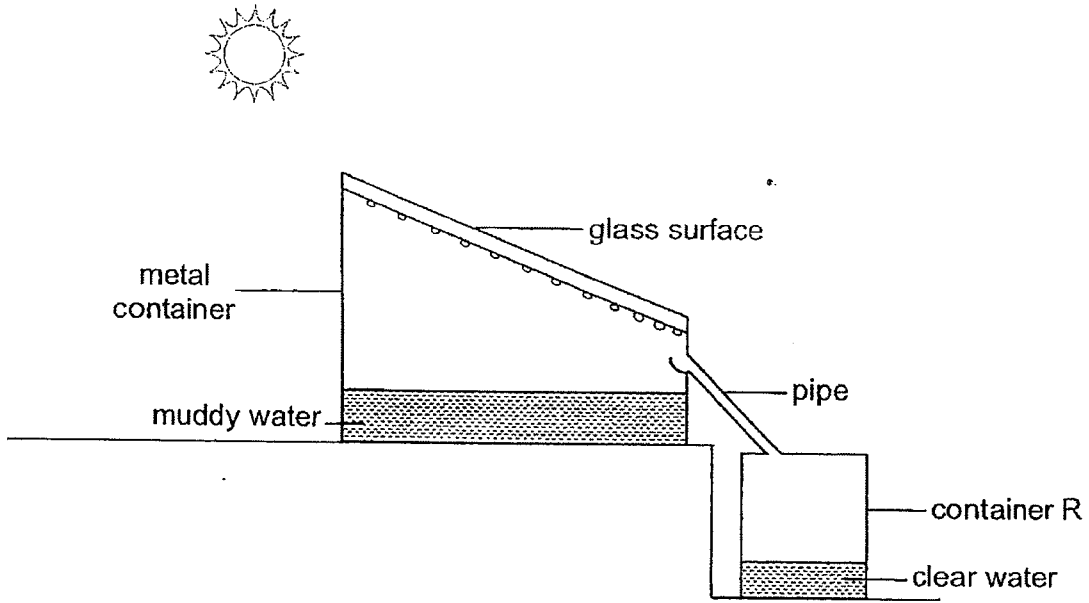

(a) Based on the diagram, explain how clear water in container R is obtained. [2]

---

---

Continue on page 7

Score	2
-------	---

Continued from page 6

The graph shows the volume of water collected in container R in a day based on the daily average temperature.

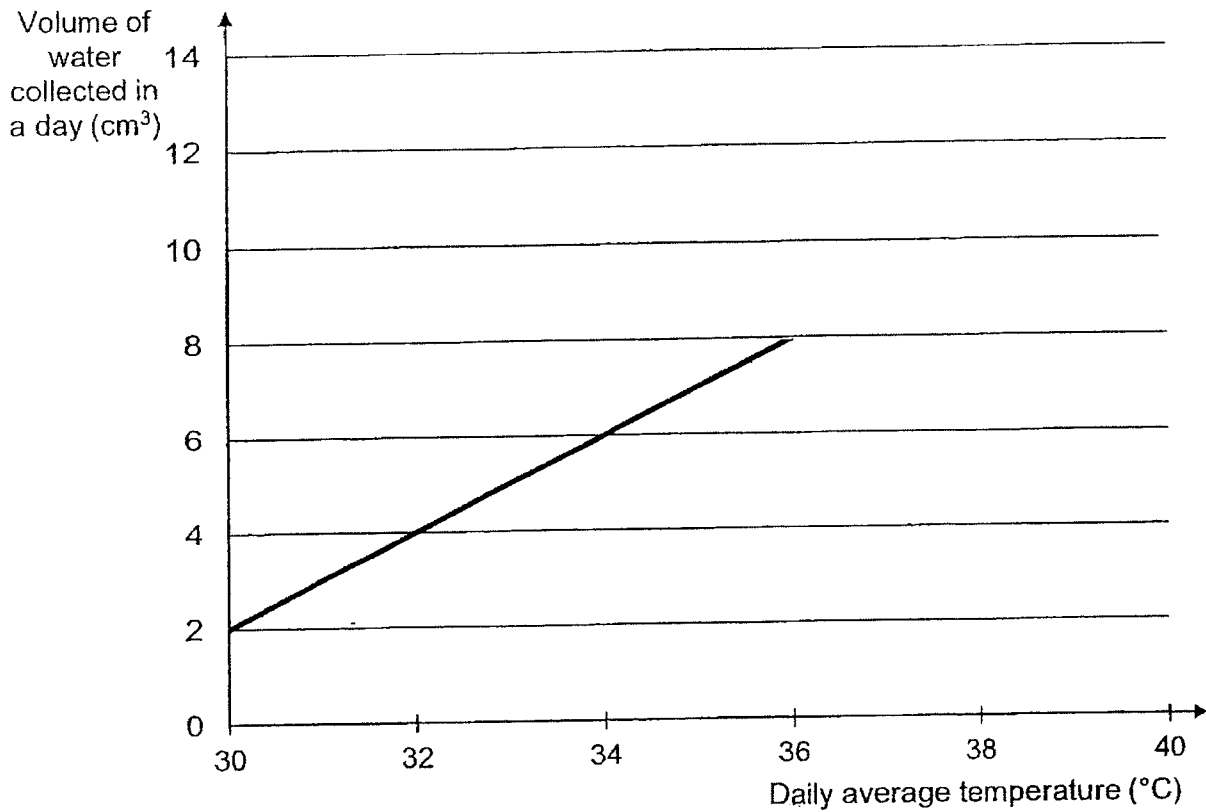

- (b) Based on the graph, predict the amount of water collected when the daily average temperature is 40°C. [1]

- (c) State the relationship between the daily average temperature and the volume of water collected in a day. [1]

Score	2
-------	---



6. The diagram shows a circuit. All the bulbs and batteries used in the circuit are in working condition. When the iron rod is resting on point K, bulb S lights up as shown in diagram C.

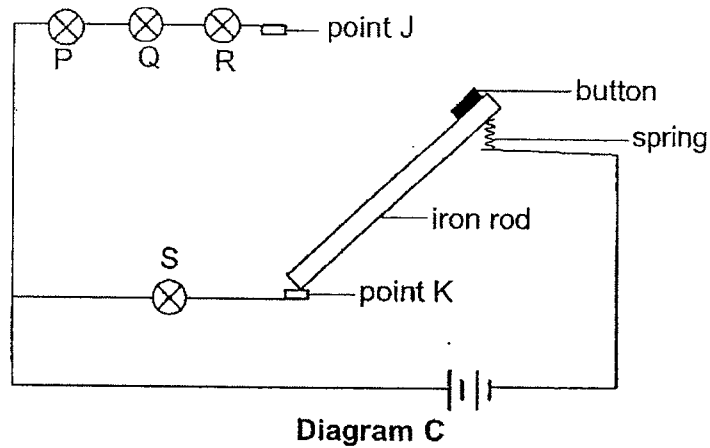

Once the button is pressed, the rod moves up and comes into contact with point J and bulbs P, Q and R will light up as shown in diagram D.

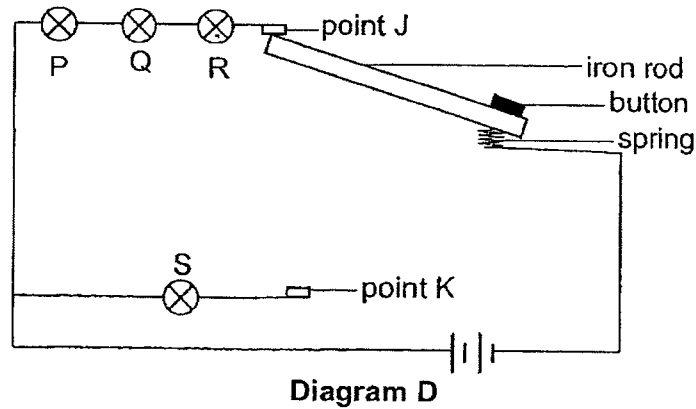

- (a) Which bulb(s) in diagram D will not light up when bulb P fuses? [1]

---

- (b) Describe what happened when the iron rod is replaced with a plastic rod in diagram D. Explain your answer clearly. [2]

---



---

Continue on page 9

Score	3
-------	---

Continued from page 8

- (c) Bulb S in diagram C lit up more brightly than bulbs P, Q, and R in diagram D. Complete the circuit diagram by drawing bulbs P, Q and R, so that they will have the same brightness as bulb S in diagram C. [1]

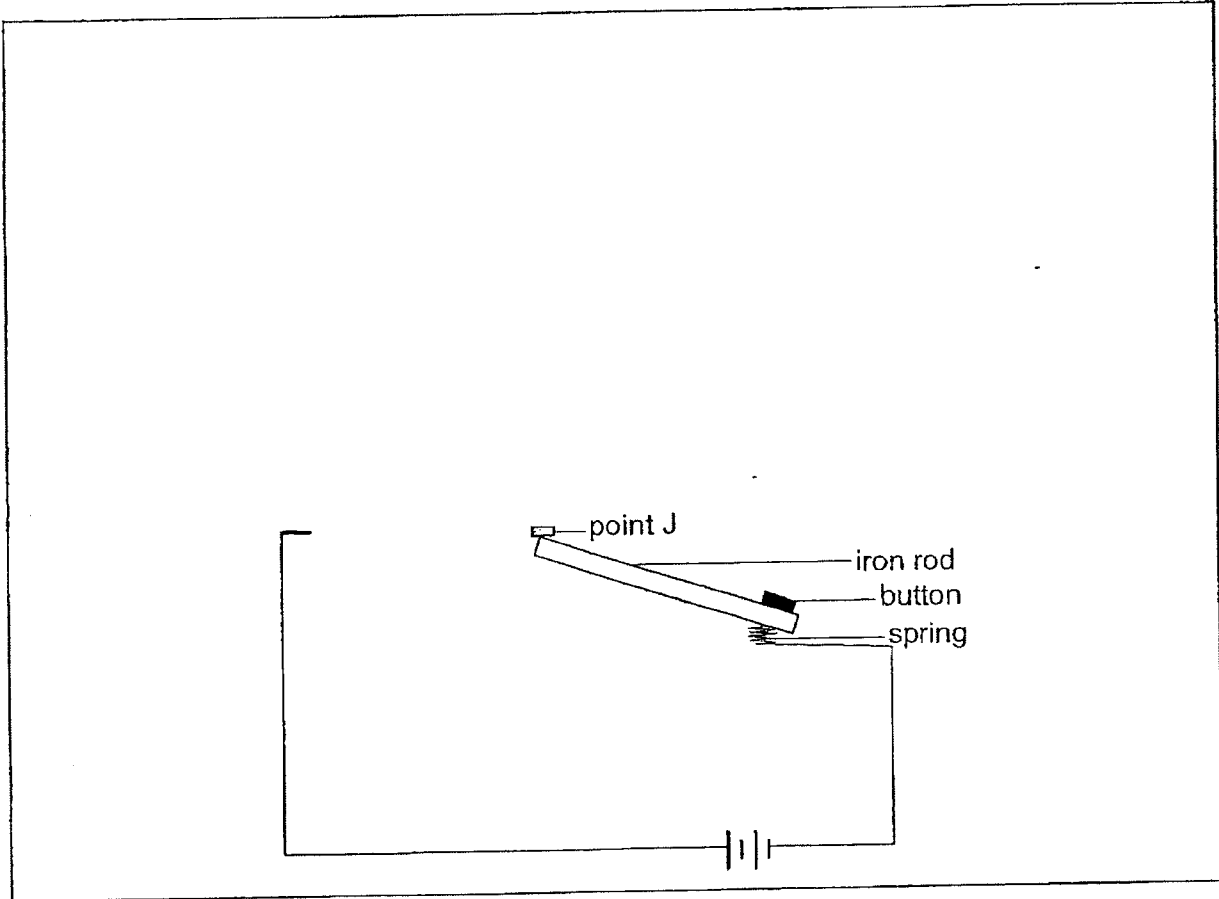

Score	1
-------	---

7. Tim set up an experiment as shown to find out how the number of stands of the container affects the temperature of water in it.

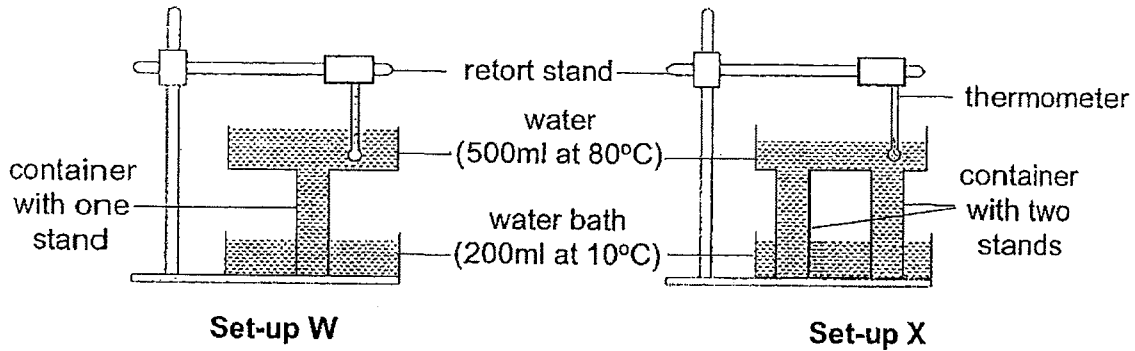

The graph shows the temperature change of water in the container.

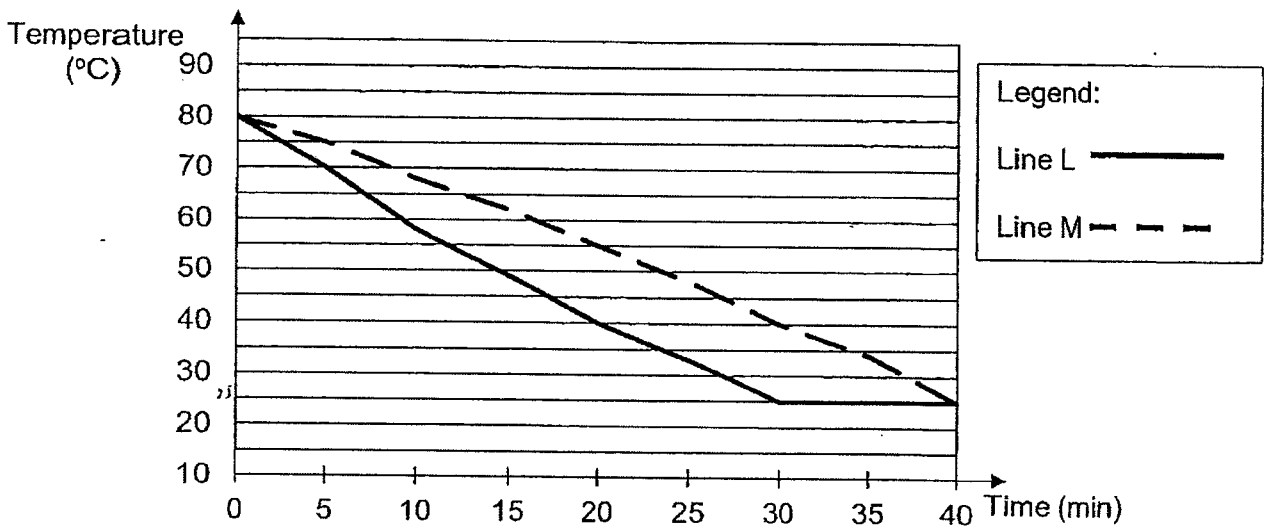

- (a) Based on the graph, state the room temperature. [1]

---

- (b) Which line, L or M, represents the temperature change of water in set-up X? Explain your answer. [2]

---



---

Score	3
-------	---

8. Three identical sized cups, E, F and G, made of different materials were each filled with 250ml of cold water. The table shows the change in temperature of the cold water in each cup over a period of twenty minutes.

Time (min)	Temperature of water in cup (°C)		
	Cup E	Cup F	Cup G
0	5	5	5
5	12	8	9
10	17	11	13
15	22	15	18
20	28	22	25

- (a) State what temperature means. [1]

---

- (b) Based on the data, arrange the cups, E, F and G, in order of their heat conductivity, starting from the best conductor of heat. [1]

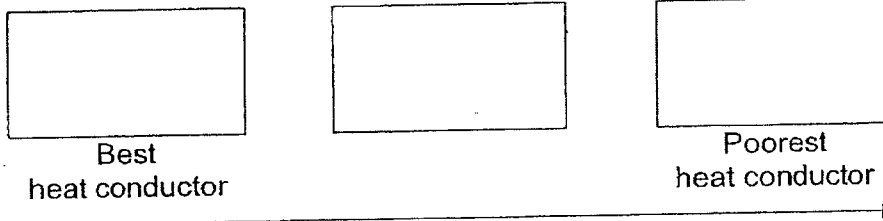

- (c) After two hours, all the cups were at the same temperature. Which one of the cups would feel the coldest to touch? Explain your answer. [2]

---



---

End of Paper

Score	4
-------	---

SCHOOL : RAFFLES GIRL'S PRIMARY SCHOOL

LEVEL : PRIMARY 6

SUBJECT : SCIENCE

TERM : WA1 2023

---

Q1)	<p>a) Organ T: Gills Organ U: Lungs</p> <p>b) oxygen</p> <p>c)</p>
Q2)	<p>a)i)carbon dioxide ii)oxygen</p> <p>b)It will decrease sunlight amount reach the jar as it is opaque. Plant cannot photosynthesis to reduce oxygen. It repress so it take in oxygen decreasing its amount in the set-P</p>
Q3)	<p>a) Number of oxygen bubbles.</p> <p>b) i)The intensity of light from the lamps. ii)Type of water plants.</p> <p>c)i)Set-up B ii)Set-up A</p> <p>c) To compare and confirm that the only difference in the number of oxygen bubbles is because of the baking soda added to the water.</p>
Q4)	<p>a) Boiling is a process when a liquid grains heat until it reaches boiling point and changes state to a gaseous state.</p>

b)

Temperature of water

(°C)

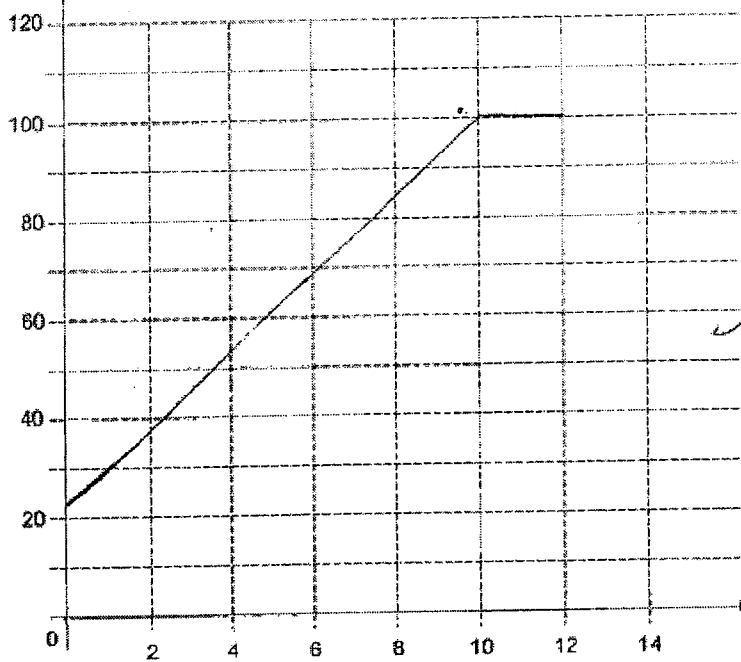

b) It changed from liquid to gas.

Q5)

a) Pure water in the muddy water gained heat from the sun and evaporated to form water vapour. The warmer water vapour came into contact with the cooler inner glass surface, lost heat and condensed to form water droplets. The water droplets slid down the glass surface through the pipe then into container R.

b) 12cm<sup>3</sup>

c) As the daily average temperature increases, the volume of water collected in a day also increases.

Q6)

a) Bulbs Q and R

b) None of the bulbs would light up. Plastic is an insulator of electricity. It would be an open circuit and electric current could not flow through the circuit. Thus, none of the bulbs would light up.

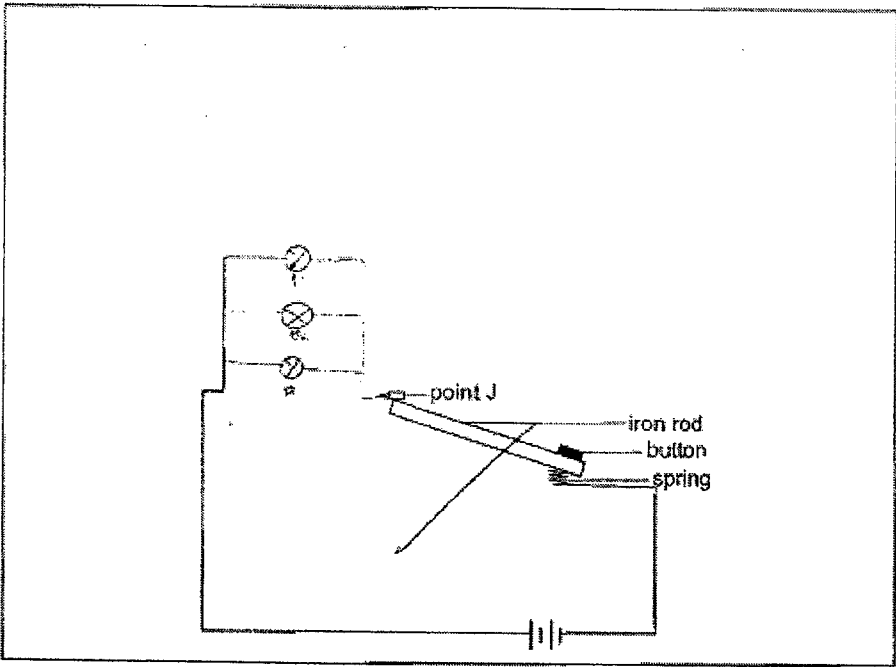
	<p>c)</p> 
Q7)	<p>a) 25°C</p> <p>b) L. Line L shows a faster change in temperature. The container in set has two stands and a greater surface area in contact with the water bath. The water in the container loses heat to the water bath faster.</p>
Q8)	<p>a) Temperature is the measurement of how hot or how cold something is.</p> <p>b) Cup E / Cup G / Cup F</p> <p>c) Cup E. Temperature of water in Cup E increases the faster. It is the best heat conductor Cup E gains heat from the hand the faster.</p>







**Rosyth School**  
**Term Assessment 2023 (Term 1)**

**SCIENCE**

**Primary 6**

Name: \_\_\_\_\_

Class: Pr 6- \_\_\_\_\_ Register No. \_\_\_\_\_

Date: 23 February 2023

Total

Marks:

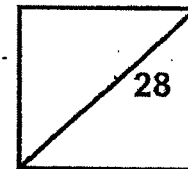

Duration: Total time for Booklets A and B: 1 h

---

## **Booklet A**

Instructions to Pupils:

1. Please do not turn this page until you are told to do so.
2. Follow all instructions carefully.
3. Answer all questions.
4. This paper consists of 2 booklets, Booklet A and Booklet B.
5. For questions 1 to 14 in Booklet A, shade the correct ovals on the Optical Answer Sheet (OAS) provided using a 2B pencil.

For each question from 1 to 14, four options are given. One of them is the correct answer. Make your choice (1, 2, 3 or 4). Write the correct answer in the OAS provided.

(28 Marks)

---

1 Study the digestive system diagram below.

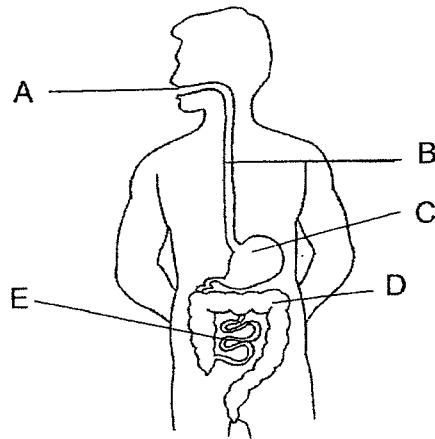

Which parts of the digestive system produce digestive juices?

- (1) C and E only
- (2) B and D only
- (3) A, C and E only
- (4) A, B, C, D and E

2 The diagram below shows how blood flows in the human body.

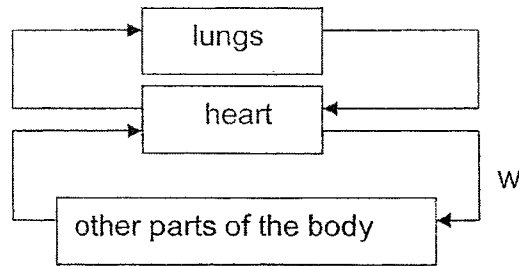

Blood samples were taken from blood vessels at W and X. The amount of oxygen in each of the blood samples was measured.

The graph below shows the amount of dissolved oxygen in W. The amount of oxygen in X was not identified.

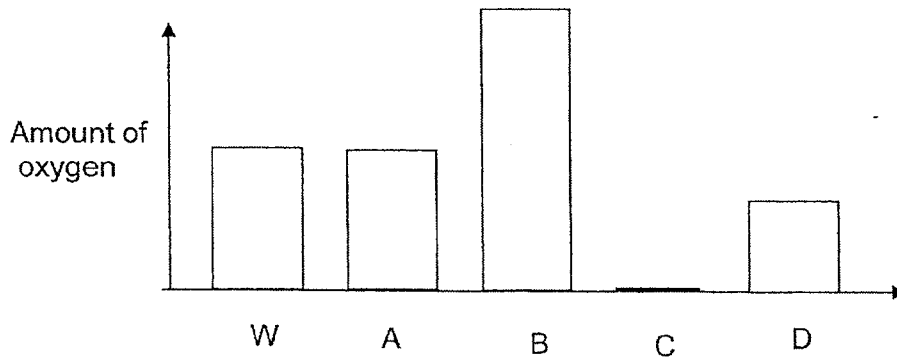

Which bar, A, B, C or D, would most probably represent the amount of oxygen in blood vessel X?

- (1) A
- (2) B
- (3) C
- (4) D

Read the following to answer questions 3 and 4.

Some researchers discovered that the rate of photosynthesis in algae can be determined by the sound level produced. The sound produced is caused by the moving tiny gas bubbles released from the algae in water.

- 3 The tiny gas bubbles are filled with \_\_\_\_\_.
- (1) air  
 (2) oxygen  
 (3) water vapour  
 (4) carbon dioxide
- 4 The researchers recorded the sound level produced by a group of algae in different areas, T, U and V.

The water conditions of T, U and V are as follows:

Area	Type of water	Concentration of carbon dioxide in water /mg per litre
T	clear water	5
U	muddy water	5
V	clear water	10

Question 4 is continued on page 5

Which of the following correctly shows the sound level of the three areas?

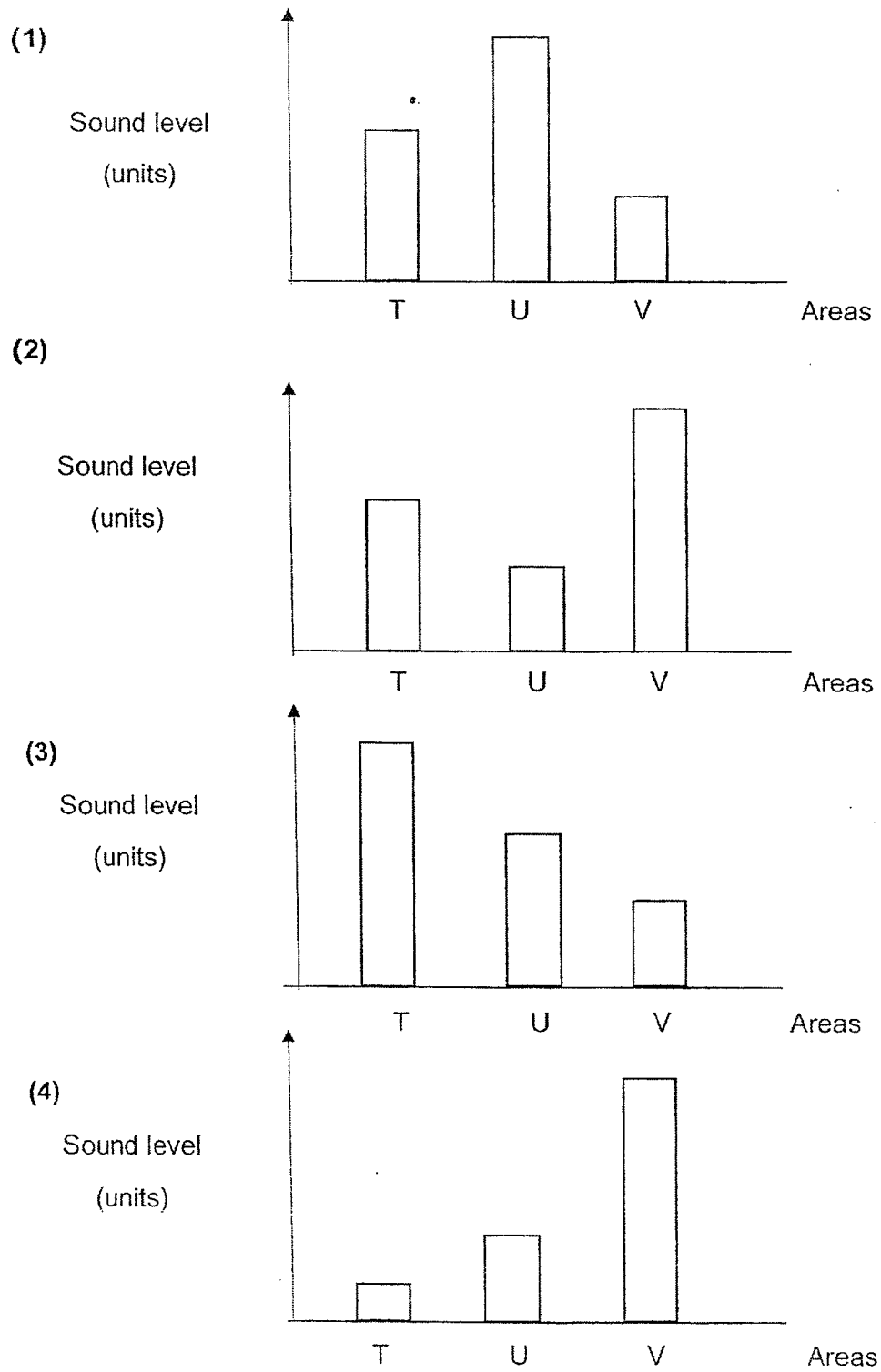

- 5 Ahmad prepared two set-ups, R and S, as shown below.

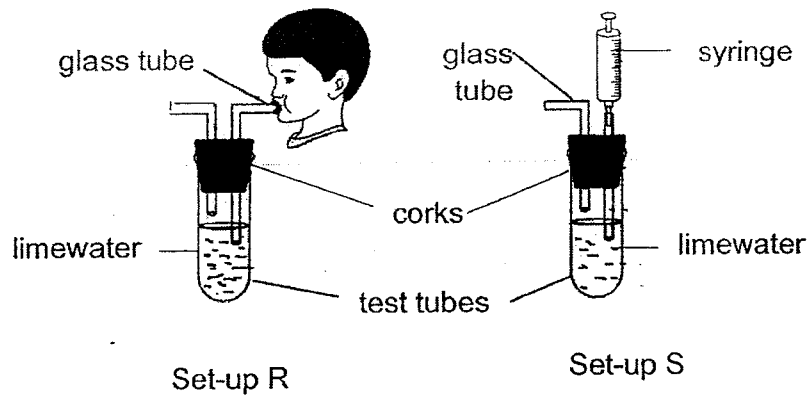

He blew air into the test tube of set-up R through the glass tube. The same amount of surrounding air was pushed through the syringe into the test-tube in set-up S. The limewater in set-up R turned milky while the limewater in set-up S remained clear.

What is the difference between inhaled air and exhaled air inferred by the above experiment?

- (1) There is more oxygen in inhaled air.
  - (2) There is more water vapour in exhaled air.
  - (3) There is more carbon dioxide in exhaled air.
  - (4) There is an equal amount of nitrogen in inhaled and exhaled air.
- 6 Photosynthesis requires \_\_\_\_\_ energy.
- (1) heat
  - (2) light
  - (3) kinetic
  - (4) potential

- 7 Ahmad was feeling cold as he was walking in a cool windy place. Then he sat down resting his bottom on a rock. Immediately, his bottom felt colder.

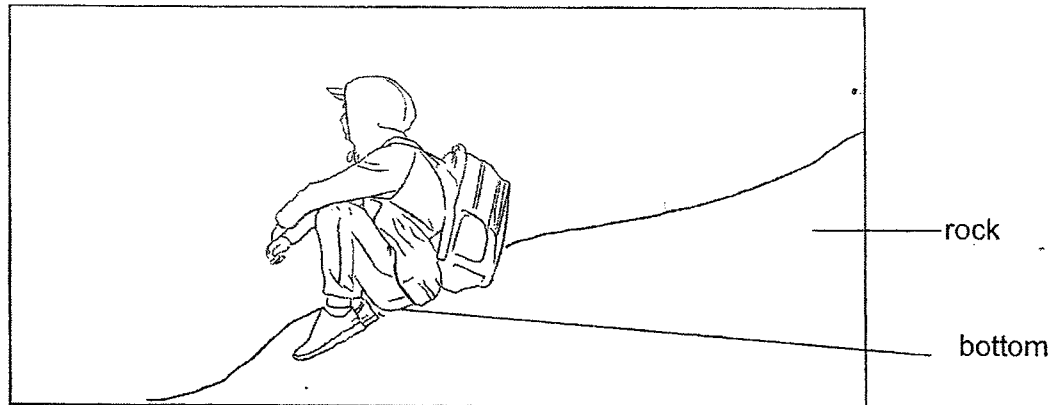

His bottom felt colder because it \_\_\_\_\_.

- (1) lost heat to the rock
- (2) did not gain heat from the rock
- (3) lost more heat to the surrounding air
- (4) is not exposed to the surrounding air

- 8 Maxine has a special drinking mug. When a hot drink is poured into the mug, the outer part of the mug will change from black to a white as shown below. As the hot drink cools down it will change to black again.

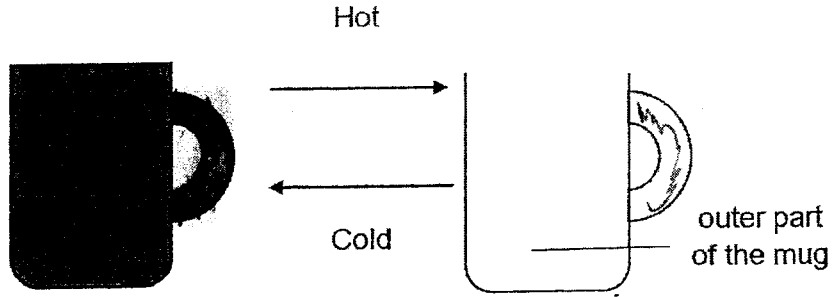

She conducted an experiment using four special mugs made of different materials, A, B, C and D. She poured the same volume of boiling water into each of the four mugs and measured the time taken for the mugs to change from black to white respectively. The results are as shown below.

Material	Time taken to change from black to white completely /minutes
A	1
B	Did not change to white
C	5
D	Immediately changed to white

Which material mug is the best to keep ice cubes?

- (1) A
- (2) B
- (3) C
- (4) D



- 9 The diagram below shows a lifeboat moving down a ramp.

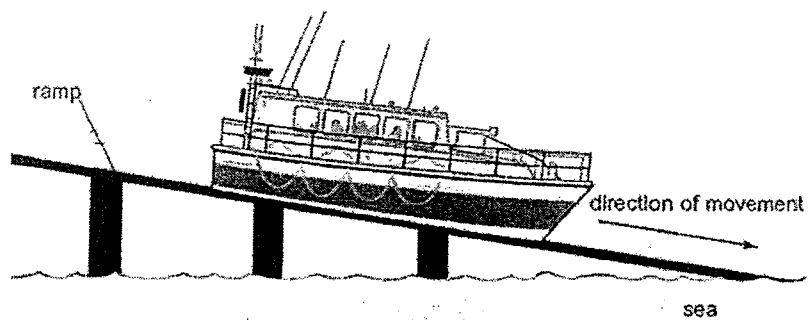

As the lifeboat is moving down, which form of energy is decreasing?

- (1) Heat energy
- (2) Sound energy
- (3) Kinetic energy
- (4) Potential energy

10 Study the diagram below.

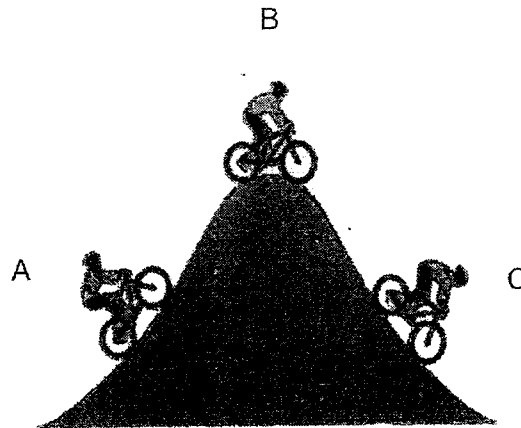

Energy conversion takes place as the cyclist moves from A to C.

Which one of the following shows the main form(s) of energy possessed by the cyclist as he moved from A to C respectively?

	<b>A</b>	<b>B</b>	<b>C</b>
(1)	Kinetic + Potential	Potential only	Kinetic only
(2)	Kinetic + Potential	Potential only	Kinetic + Potential
(3)	Kinetic only	Potential only	Kinetic + Potential
(4)	Kinetic + Heat	Potential + Kinetic	Kinetic + Heat

11 The diagram below is a simplified model of how a steamship works.

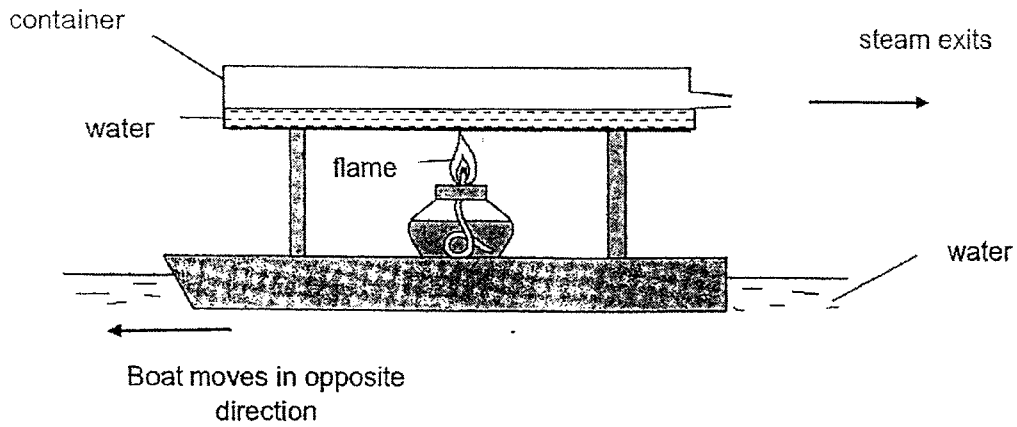

Based on the diagram, which of the following correctly describes the energy conversion in a steamship?

- (1) Heat energy + Light energy  $\longrightarrow$  Kinetic energy
- (2) Kinetic energy  $\longrightarrow$  Heat energy  $\longrightarrow$  Kinetic energy
- (3) Chemical potential energy  $\longrightarrow$  Heat energy  $\longrightarrow$  Kinetic energy
- (4) Chemical potential energy  $\longrightarrow$  Light energy  $\longrightarrow$  Kinetic energy

- 12 Sufen conducted an experiment with a wound-up toy car. At each try, she changed the number of turns of the key and measured the distance travelled by the toy car upon release.

Which of the following is/ are possible aim(s) for the above experiment?

A: To find out if amount of potential energy will affect amount of kinetic energy

B: To find out if the mass of the toy car will affect the distance travelled by the toy car

C: To find out if the number of turns of the key will affect the distance travelled by the toy car

(1) B only

(2) C only

(3) A and C only

(4) B and C only

- 13 The diagram below shows how energy can be converted from one form to another.

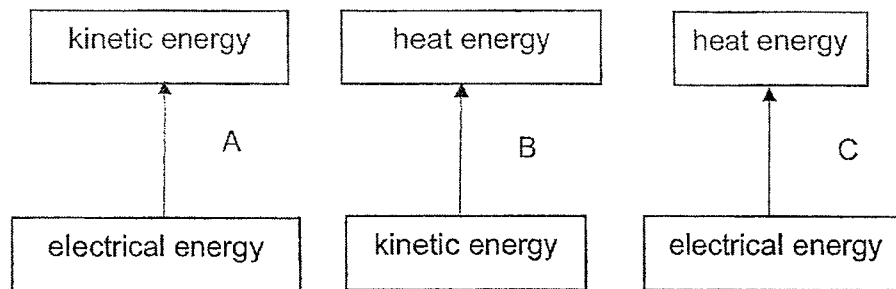

Which set of activities best represents the conversion of energy as shown above?

	<b>A</b>	<b>B</b>	<b>C</b>
(1)	Moving flag	Toasting a bread in an oven	Cooking rice in pressure cooker
(2)	Moving car	Moving flag	Turning a wind turbine
(3)	Moving escalator	Pushing a table across a floor	Rubbing hands together
(4)	Moving lift	Rubbing hands together	Toasting a bread in an oven

14 The diagram below shows a solar cooker.

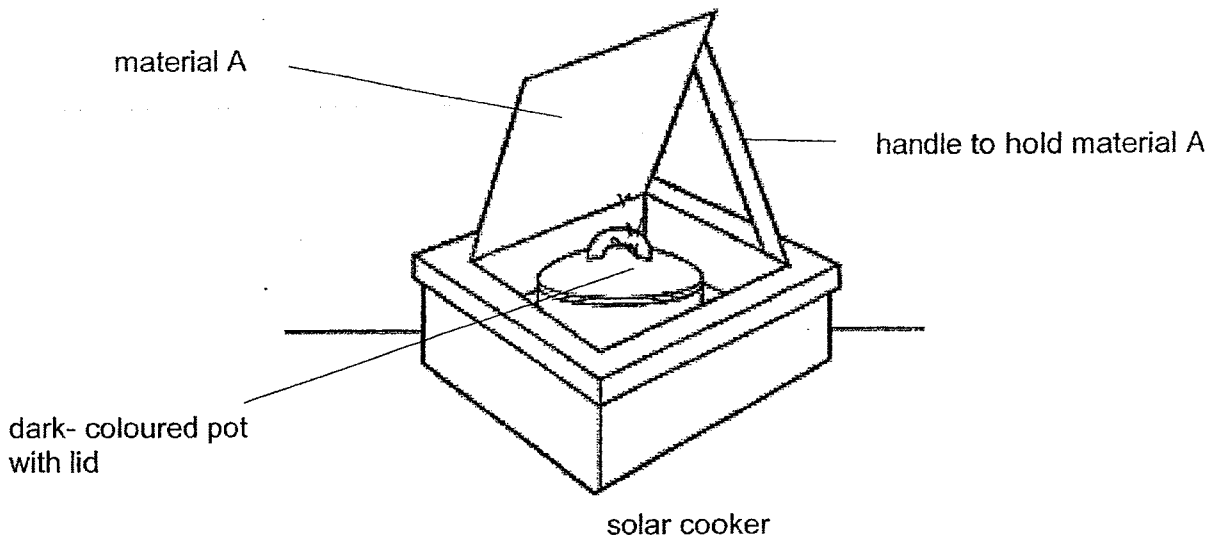

Solar cooker uses the rays of the sun to cook the food in the dark-coloured pot with lid.

Which of the following shows the correct energy conversion and the best material for A in a solar cooker?

	<b>Energy conversion</b>	<b>Material A</b>
(1)	Heat energy to Light energy	dull and black
(2)	Heat energy to Potential energy	shiny and reflective
(3)	Light energy to Heat energy	dull and black
(4)	Light energy to Heat energy	shiny and reflective

(Go to Booklet B)