



**HENRY PARK PRIMARY SCHOOL**

**PRELIMINARY ASSESSMENT 2020**

**PRIMARY 6**

**SCIENCE**

**BOOKLET A (56 MARKS)**

**INSTRUCTIONS TO CANDIDATES**

1. Do not turn over this page until you are told to do so.
2. Follow all instructions carefully.
3. Answer all questions.
4. Shade your answers on the Optical Answer Sheet (OAS) provided.

Name: \_\_\_\_\_ (      )

Class: Primary 6 (      )

Date: 25 August 2020

Total Time: 1 h 45 min

<b>Booklet</b>	<b>Marks</b>	
<b>A</b>		/ 56
<b>B</b>		/ 44
<b>Total (A+B)</b>		/ 100

Parent's Signature: \_\_\_\_\_

**Booklet A (56 marks)**

For each question from 1 to 28, four options are given. One of them is the correct answer. Make your choice (1, 2, 3 or 4). Shade the correct oval (1, 2, 3 or 4) on the **Optical Answer Sheet**.

1. The diagrams show 2 trees, R and S, at the same location in a garden.

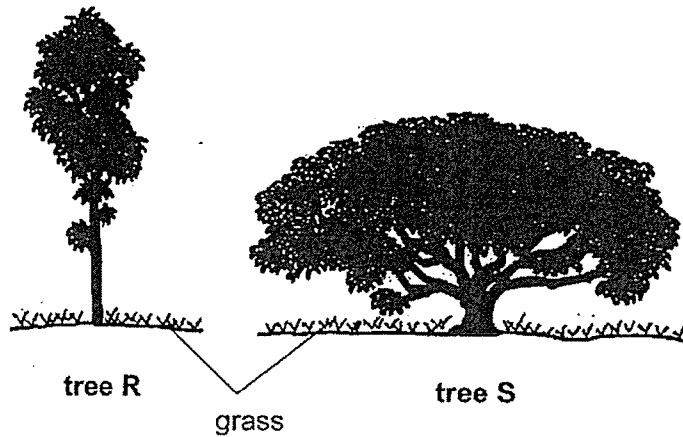

Jack noticed that the grass under one of the trees grew more healthily than that of the other.

Which of the following correctly shows the tree under which the grass was healthier and the reason?

	Tree	Reason
(1)	R	The grass gets more sunlight to make food.
(2)	R	Fewer animals can make their homes in the tree.
(3)	S	The temperature under the tree is lower.
(4)	S	The grass does not get beaten by the falling rain.

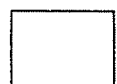

2. Joel saw animal X in a muddy area.







Animal X

Animal X has the following characteristics:

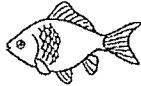
- A It has fins.
- B It lays eggs.
- C It breathes through gills.
- D Its body is covered with scales.

Joel was told to classify animal X in either Group P or Group Q as shown below.

Group P	Group Q
  	  

Which of the characteristics of animal X would help Joel in his classification?

- (1) A and C only
- (2) B and C only
- (3) A, C and D only
- (4) A, B and D only

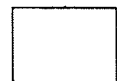

3. The graph below shows the number of days of each stage in the life cycle of an insect.

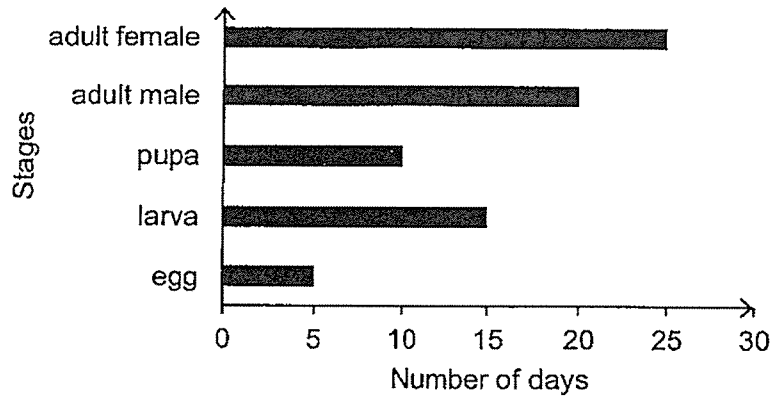

Based on the graph, Johari wrote the following statements.

- A The larva takes 5 days to hatch from the egg.
- B The insect takes 40 days to become an adult.
- C The male insect dies soon after it fertilises the eggs.
- D The insect takes 25 days to change from larva to pupa.

Which of the above statement(s) is/are correct?

- (1) A only
- (2) B only
- (3) A and C only
- (4) B and D only



4. The diagram below shows what the inside of a seed looks like.

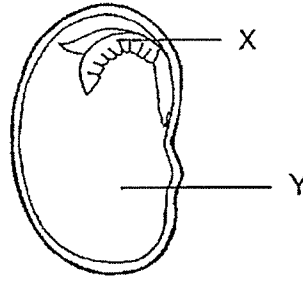

Which of the following graphs correctly shows the change in mass of parts X and Y if the seed is germinating and growing?

(1)

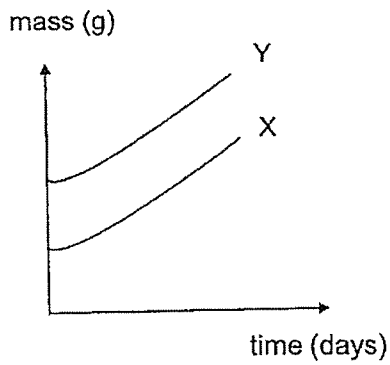

(2)

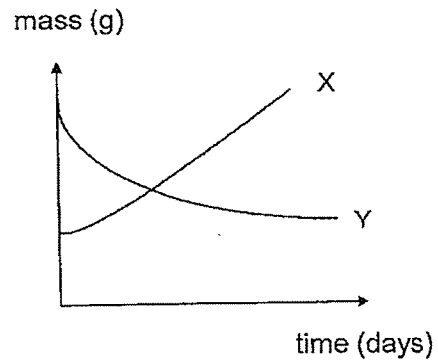

(3)

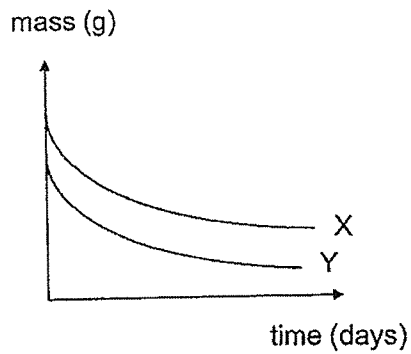

(4)

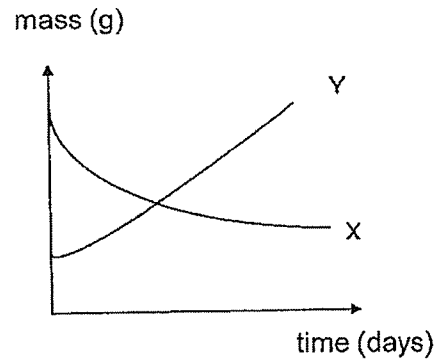

5. Dina placed five identical small plants into separate pots of the same size containing the same amount of soil.

She wanted to investigate how different conditions affect the growth of plants.

The different conditions are shown in the table below. A tick (✓) represents the presence of the factors.

Condition	Pot A	Pot B	Pot C	Pot D	Pot E
Presence of water	✓	✓	✓	-	✓
Presence of sand	✓	-	✓	✓	✓
Presence of light	✓	✓	-	✓	✓
Presence of minerals	-	✓	✓	✓	✓

The diagrams show Dina's plants after one week.

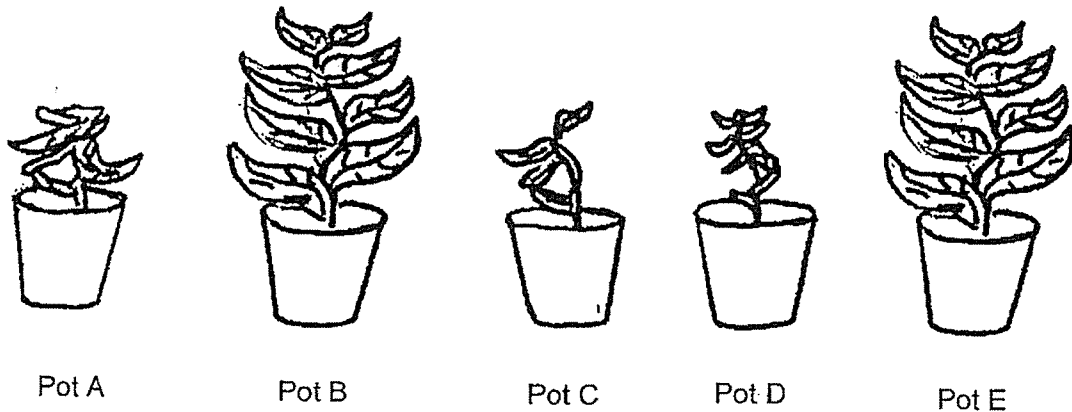

According to Dina's results, which factor has the least effect on plant growth?

- (1) water
- (2) sand
- (3) light
- (4) minerals



6. The diagram shows blood flowing through the large intestine of the human body.

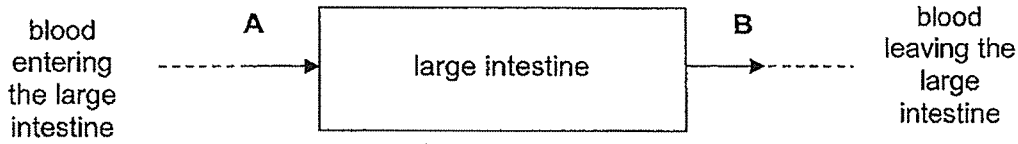

Which of the following is correct about the amount of oxygen, carbon dioxide and water in the blood flowing in A as compared to B?

Blood flowing in A has		
(1)	more oxygen	less carbon dioxide
(2)	more oxygen	more carbon dioxide
(3)	less oxygen	more carbon dioxide
(4)	less oxygen	less carbon dioxide

7. The diagram below shows the male reproductive system in human.

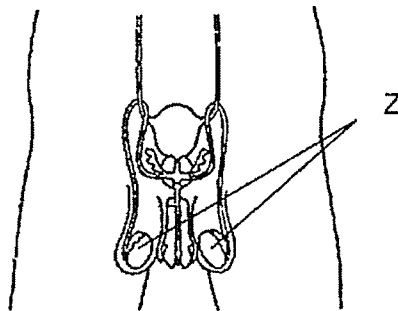

If parts Z are removed, what will most likely happen as a result?

- (1) The production of sperms will not take place.
- (2) The number of sperms produced will be reduced.
- (3) The sperms produced will not be able to fertilise the eggs.
- (4) The movement of sperms towards the eggs will be slower.



8. Ahmad opened up fruit D shown below and found many seeds inside.

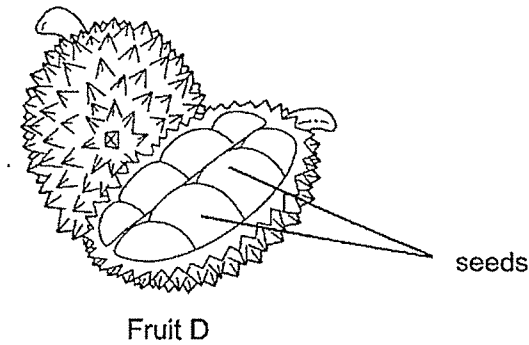

Which of the following statements about fruit D are correct?

- A There were many ovules in the ovary of the flower.  
 B Pollination and fertilisation had taken place to form the fruit above.  
 C The strong smelling seeds attracted animals to eat and help dispersed them. ✓
- (1) A and B only  
 (2) A and C only  
 (3) B and C only  
 (4) A, B and C
9. The diagram shows process P carried out by plants.

Process P

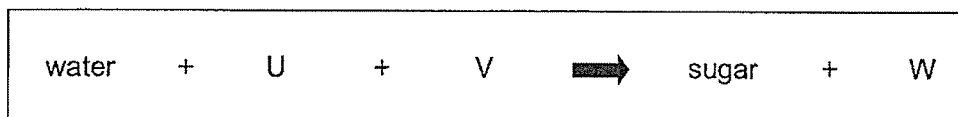

Which of the following correctly describes U, V and W?

	U	V	W
(1)	carbon dioxide	warmth	oxygen
(2)	oxygen	warmth	carbon dioxide
(3)	oxygen	light	carbon dioxide
(4)	carbon dioxide	light	oxygen





10. The diagram shows the stages and processes X and Y in the life cycle of a flowering plant.

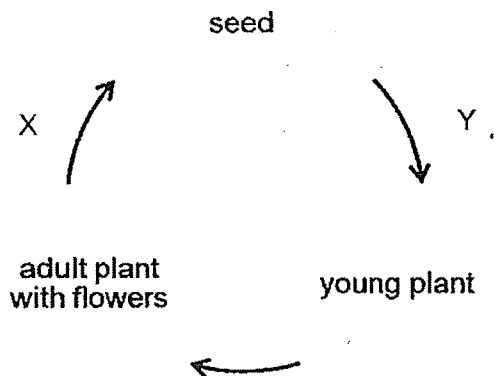

Which of the following correctly shows the possible process for X and Y?

	Process X	Process Y
(1)	germination	dispersal
(2)	fertilisation	pollination
(3)	fertilisation	germination
(4)	dispersal	pollination



11. Mary set up an experiment as shown below.

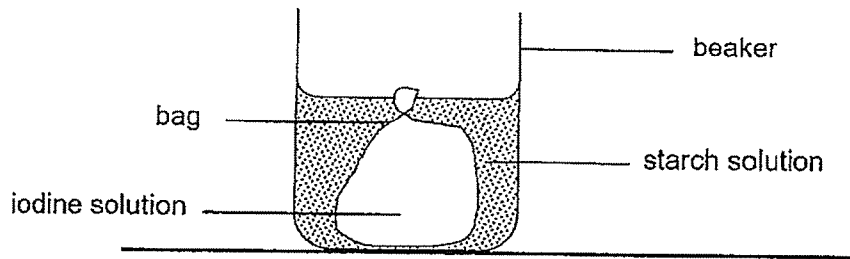

After a few hours, a dark blue coloration was observed in the starch solution outside the bag in the beaker.

The diagram below shows a plant cell.

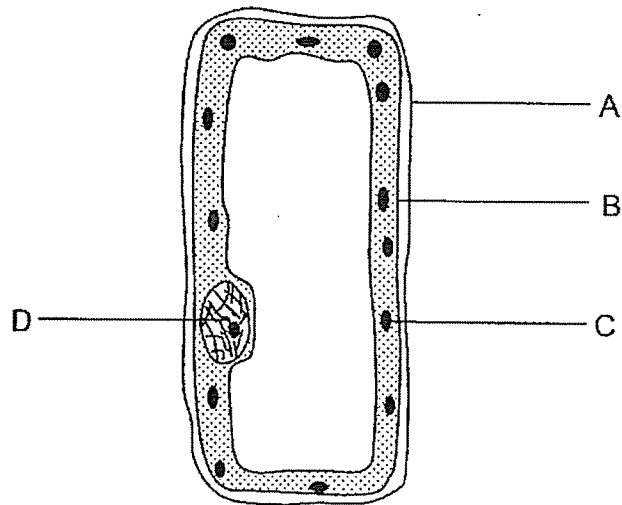

Which part of the cell, A, B, C or D, does the bag in Mary's experiment represent?

- (1) A
- (2) B
- (3) C
- (4) D



12. Hashim wanted to find out the effect of substance W on an aquatic plant. He placed some water moss fern in a beaker of water containing substance W as shown below.

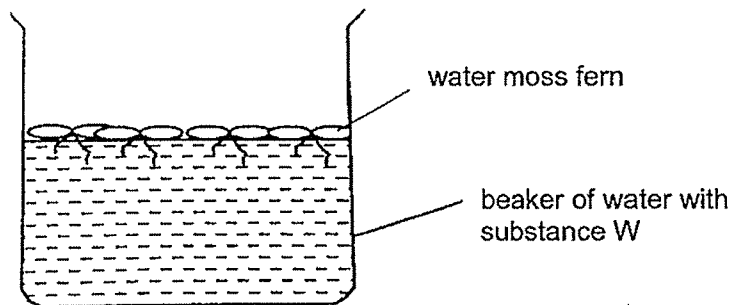

Which of the following should Hashim do to enable him to compare the effect of substance W on the water moss fern after two weeks?

- A Pour a layer of oil on the water at the start.
- B Set up a control beaker containing water and water moss fern only at the start.
- C Measure the mass of water moss fern after two weeks.
- D Count the number of water moss fern that are alive after two weeks.

- (1) A and B only
- (2) C and D only
- (3) A, C and D only
- (4) B, C and D only



13. The diagram below shows several air sacs, surrounded by blood vessels, which are found in our lungs. The blood vessel X carries blood from the heart while the blood vessel Y carries blood to the heart.

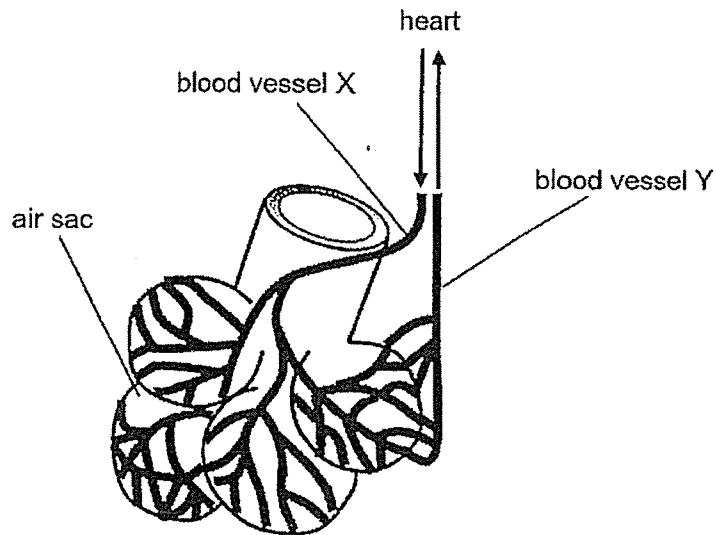

Which of the following statements are correct about X, Y and the air sac?

- A The blood in X is richer in oxygen than the blood in Y.
- B The blood in Y is poorer in carbon dioxide than the blood in X.
- C The air leaving the air sac and out of the lungs contains nitrogen.
- D The blood vessels around the air sac help to exchange gases efficiently.

- (1) A and B only
- (2) C and D only
- (3) B, C and D only
- (4) A, B and D only

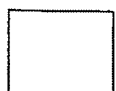

14. Ravi placed a bell jar over a plant which had been watered. He then covered the bell jar with a thick black cloth. Next, he placed his set-up under the sun from 9 a.m. to 12 noon.

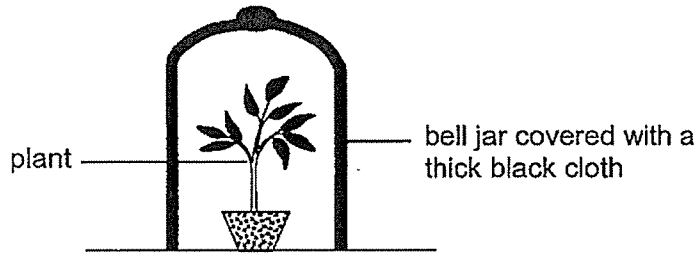
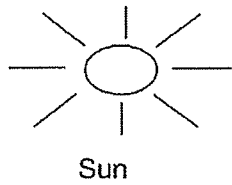

Which one of the following graphs shows correctly the changes in the amount of carbon dioxide and oxygen in the bell jar during the period of time?

(1) amount of gas ( $\text{cm}^3$ )

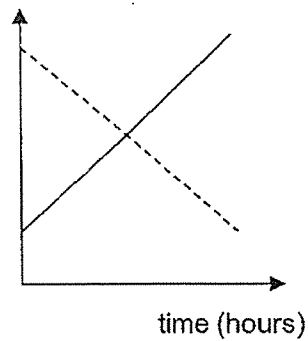

(2) amount of gas ( $\text{cm}^3$ )

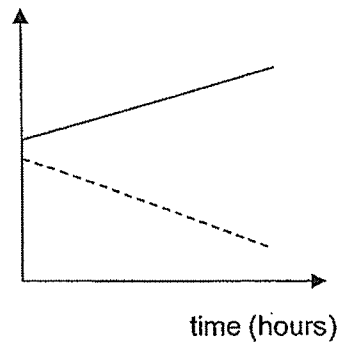

(3) amount of gas ( $\text{cm}^3$ )

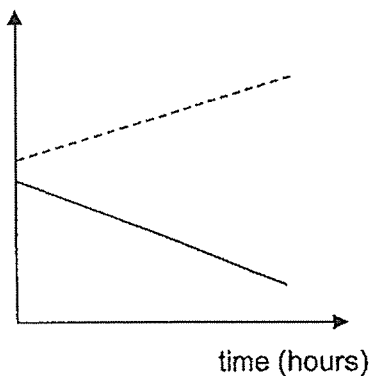

(4) amount of gas ( $\text{cm}^3$ )

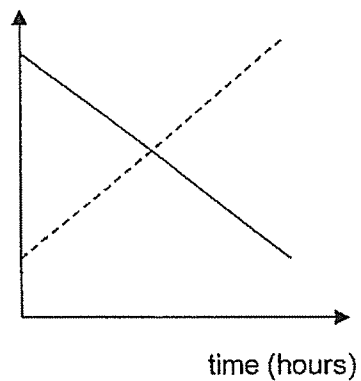

Key:

- oxygen
- - - carbon dioxide



15. The flow chart below shows some properties of materials A, B, C, D, E and F.

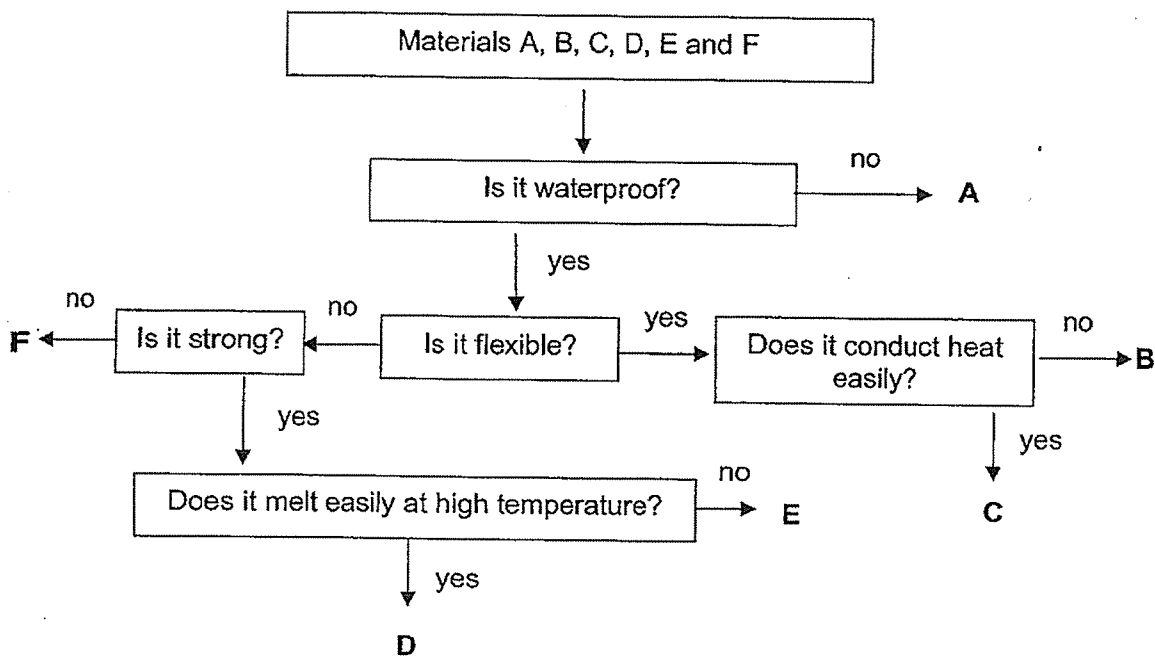

Based on the information above, which of the following shows the most suitable material for making gloves and helmets for firemen?

	Gloves	Helmets
(1)	A	C
(2)	B	D
(3)	B	E
(4)	C	F



16. The diagrams show three objects of different shapes and made of different materials.

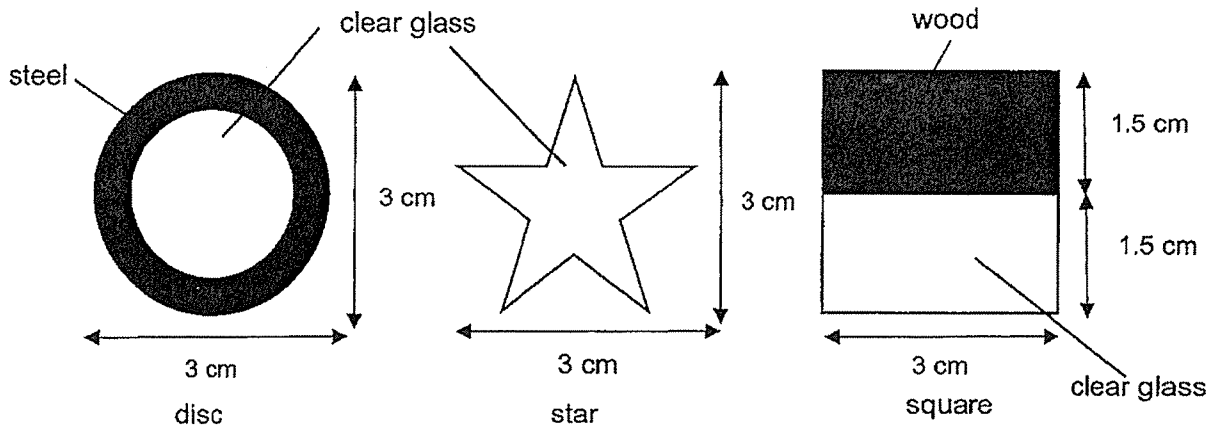

The three objects were glued together. They were placed between a torch and a screen as shown below.

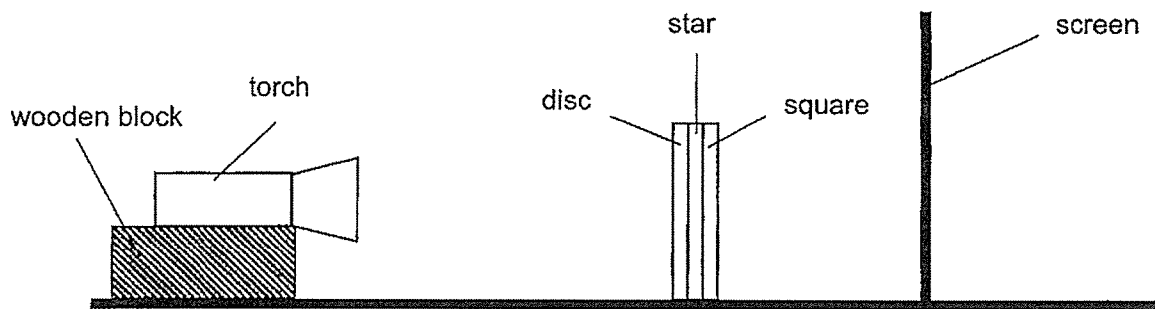

Which one of the following shows the shadow cast on the screen?

(1)



(2)

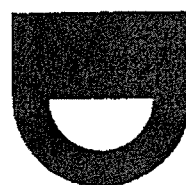

(3)



(4)



17. Two substances, S and T, were in a beaker placed on a table as shown below.

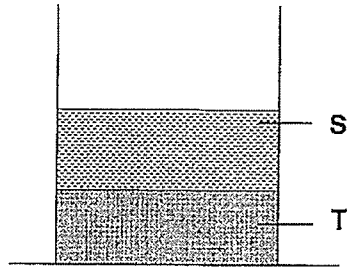

The same beaker was then placed on a wooden wedge as shown below.

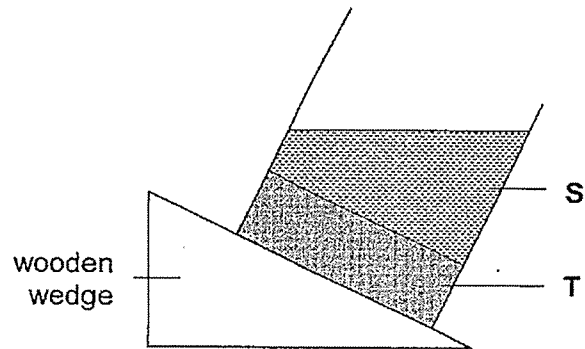

Based on the diagrams above, which of the following statements about substances S and T are correct?

- A Substances S and T occupy space.
- B Substances S and T have definite volumes.
- C Substance S cannot be compressed but substance T can.
- D Substance S has a definite shape but substance T does not.

- (1) A and B only
- (2) C and D only
- (3) A, B and D only
- (4) B, C and D only

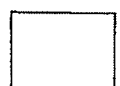



18. Study the diagram below carefully. The capacity of the enclosed glass container is  $800 \text{ cm}^3$  and it contains some water at the start.

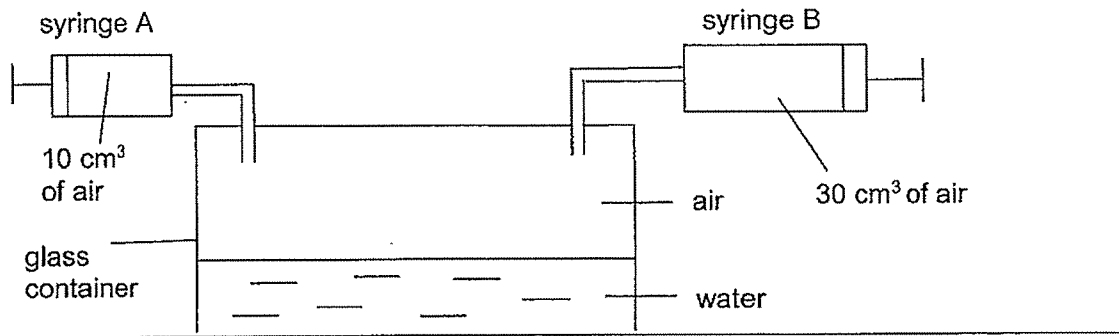

When syringes A and B are pushed in completely twice, the final volume of air in the glass container becomes  $480 \text{ cm}^3$ .

What is the volume of water in the glass container before the syringes are pushed in?

- (1)  $280 \text{ cm}^3$
- (2)  $320 \text{ cm}^3$
- (3)  $400 \text{ cm}^3$
- (4)  $720 \text{ cm}^3$



19. Roy placed a torch at position K. The torch shone at an object that was placed at position M as shown below. A shadow was cast on the screen.

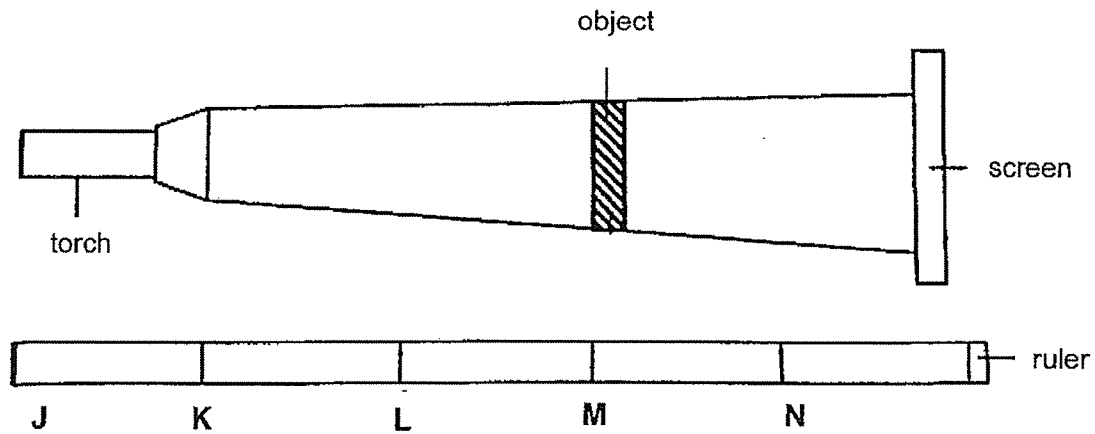

At which positions of the ruler should the torch and the object be placed so as to obtain a bigger shadow on the screen than before?

	Position of torch	Position of object
A	K	N
B	J	K
C	L	M
D	J	N

- (1) A and C  
 (2) A and D  
 (3) B and C  
 (4) B and D

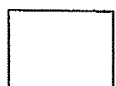

20. Anne set up an experiment as shown below using two iron bars, P and Q, which have a mass of 40 g each.

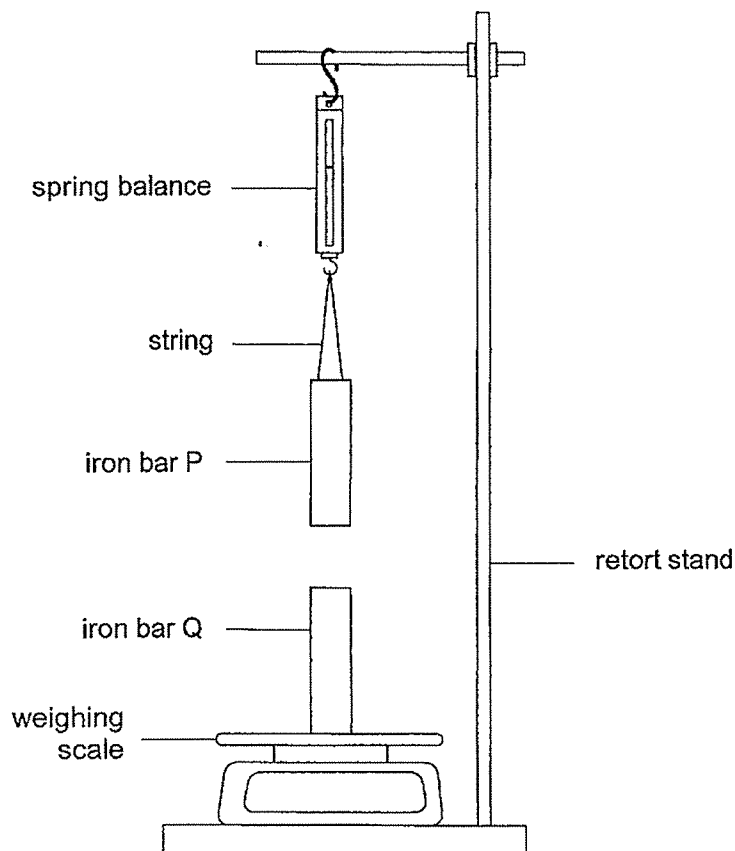

The table below shows the readings on the weighing scale and spring balance when the iron bars were arranged as shown above.

Reading on spring balance	Reading on weighing scale
Less than 40 g	More than 40 g

Based on the results in the table above, which one of the following statements is most likely to be correct?

- (1) Iron bar P and iron bar Q are both magnets.
- (2) Iron bar Q can attract more iron nails than iron bar P.
- (3) There is force of attraction between iron bar P and iron bar Q.
- (4) When iron bar Q is turned upside down, the reading on the spring balance will decrease. (     )



21. Sharon had four mugs of the same size and thickness. They were made of different materials W, X, Y and Z. She filled each mug with 250 ml of hot water at 60°C. The temperature of the water in the mugs was then measured every two minutes.

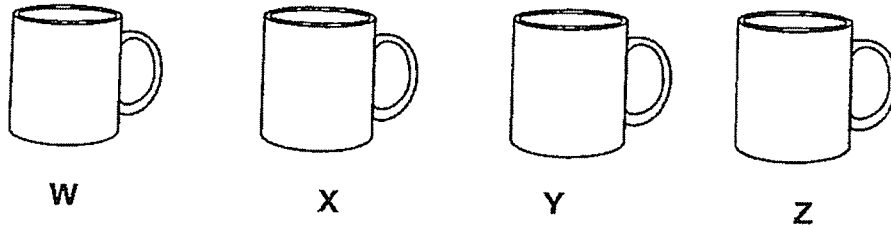

The results of the experiment were plotted on the graph below.

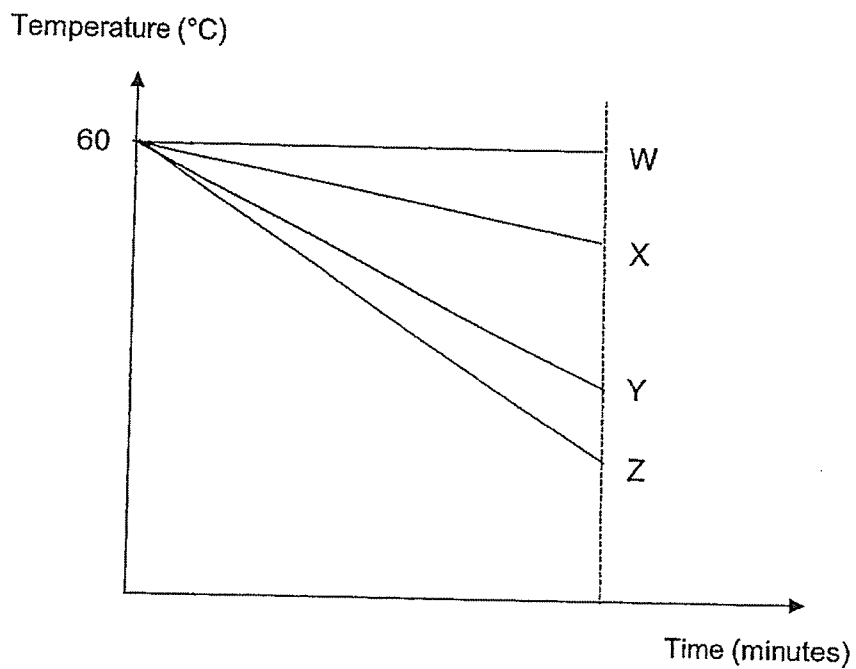

Which of the following statements about the four materials are correct?

- A Material X is a poorer conductor of heat than material Z.
- B Material Z is the best conductor of heat among the four materials.
- C Water will heat up the fastest if it is placed in the mug made of material W.
- D Water remained hot for a longer period of time in the mug made of material Y than material X.

- (1) A and B only
- (2) C and D only
- (3) A, B and D only
- (4) A, C and D only

( )



22. The diagram shows the movement of water in the environment.

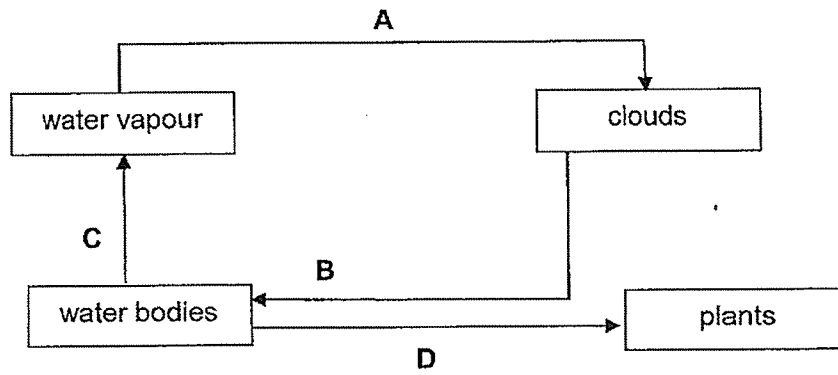

Based on the diagram given, which of the following correctly shows the change in state of water?

	From liquid to gas	From gas to liquid
(1)	B	D
(2)	C	A
(3)	C	A and B
(4)	A and D	B



23. John set up a circuit as shown below which consists of three bulbs, A, B and C, as well as three different materials, X, Y and Z.

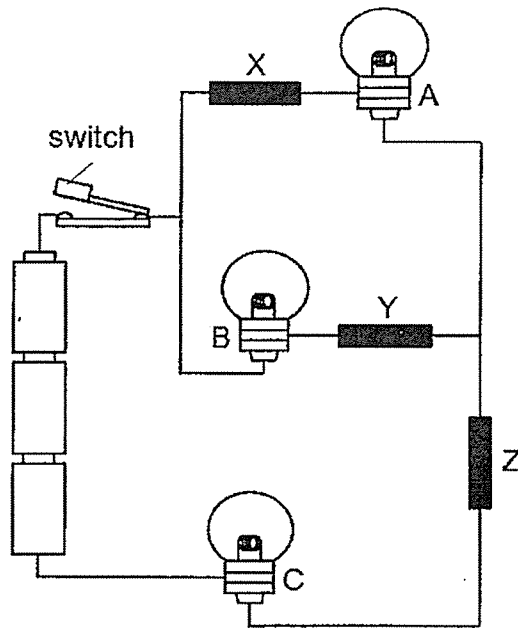

When the switch is closed, only bulbs B and C lit up.  
What are some possible reasons for this observation?

- A Bulb A has fused.
- B Material X cannot conduct electricity.
- C The batteries are not connected properly.
- D Materials Y and Z are conductors of electricity.

- (1) A and C only
- (2) B and D only
- (3) A, B and D only
- (4) A, B, C and D

( )



24. Joyce made a toy with a block and a balloon. She pumped air into the balloon and then released it. The toy moved on the surface of the table in the direction shown by the arrow in the diagram below. It came to a stop at position X.

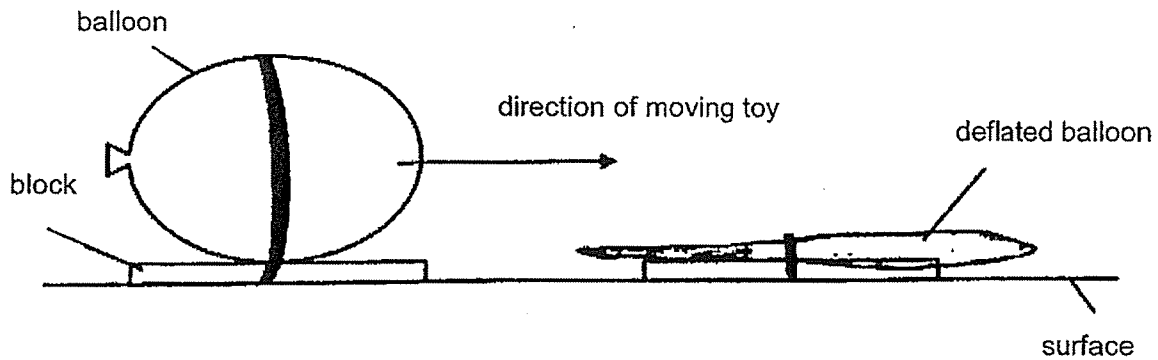

Which of the following correctly shows the energy conversion in the toy beginning with the balloon filled with air?

- (1) chemical potential energy  $\longrightarrow$  gravitational potential energy  $\longrightarrow$  heat energy + sound energy
- (2) gravitational potential energy  $\longrightarrow$  kinetic energy + heat energy + sound energy
- (3) gravitational potential energy  $\longrightarrow$  elastic potential energy + kinetic energy + heat energy + sound energy
- (4) elastic potential energy  $\longrightarrow$  kinetic energy  $\longrightarrow$  kinetic energy + heat energy + sound energy ( )



25. Peter hung three wooden blocks, A, B and C, one at a time, from a string and released each one from either position X or Y as shown in the diagram below.

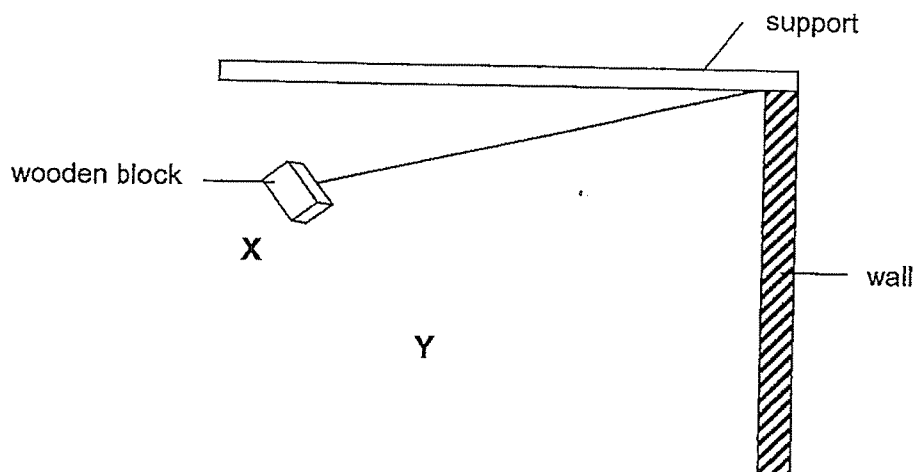

The mass of each block and the position from which it was released are shown in the table below.

Wooden block	Mass of wooden block (g)	Position from which it was released
A	100	X
B	200	X
C	100	Y

Each time the block hit the wall, a sound was produced. Peter measured the sound level using a data logger and recorded his findings. Which of the following correctly shows the sound level recorded for each wooden block?

Sound recorded in units			
	A	B	C
(1)	300	350	300
(2)	350	300	350
(3)	300	350	225
(4)	225	300	350

( )





26. Arif dropped a ball from a table. The dotted lines shown in the diagram below represent the path that the ball took.

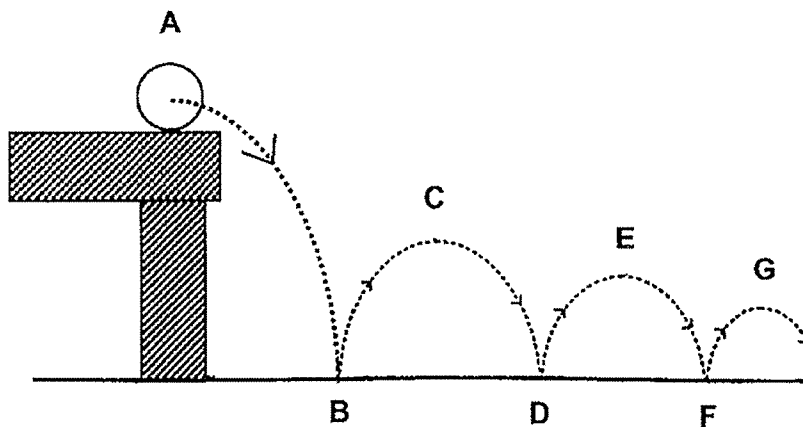

Based on the diagram, Arif wrote the following statements in his notebook.

- A The kinetic energy increases from A to B.
- B The kinetic energy decreases from D to E.
- C The potential energy remains unchanged from A to C.
- D The potential energy increases from F to G.

Which of the statements written by Arif are correct?

- (1) A and B only
- (2) A and D only
- (3) A, B and D only
- (4) B, C, and D only

( )



27. Kai and Don were playing a game of Frisbee (a light plastic disc). Kai threw the Frisbee as shown in diagram 1.

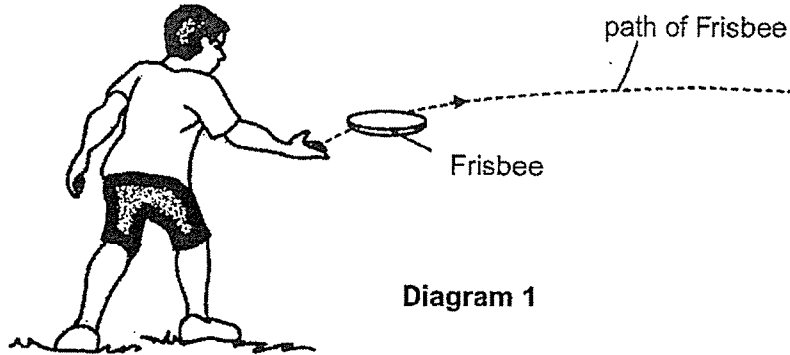

Don tried to catch the Frisbee as shown in diagram 2 but failed. He only managed to touch the Frisbee.



Which of the following statements about forces correctly explain the result of Kai's and Don's actions?

	<b>Kai</b>	<b>Don</b>
(1)	A force stops a moving object.	A force changes the direction of a moving object.
(2)	A force changes the speed of a moving object.	A force causes a stationary object to move.
(3)	A force causes a stationary object to move.	A force changes the speed of a moving object.
(4)	A force changes the shape of an object.	A force stops a moving object.

( )



28. The diagram below shows a car driving up a slope.

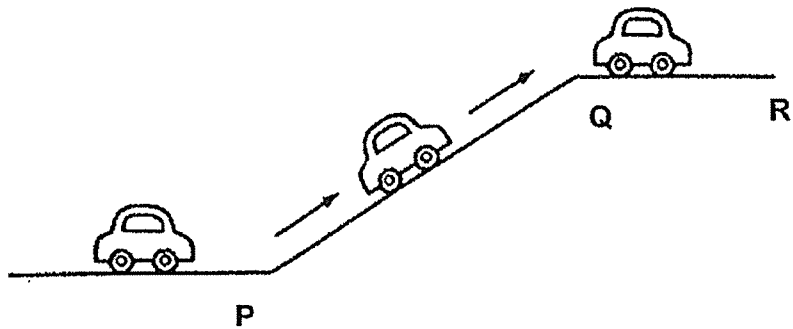

Which of the following correctly shows the change in gravitational force as the car moves from P to Q and from Q to R?

	P to Q	Q to R
(1)	increases	increases
(2)	increases	remains unchanged
(3)	remains unchanged	increases
(4)	remains unchanged	remains unchanged

( )

End of Booklet A





**HENRY PARK PRIMARY SCHOOL**

**PRELIMINARY ASSESSMENT 2020**

**PRIMARY 6**

**SCIENCE**

**BOOKLET B (44 MARKS)**

**INSTRUCTIONS TO CANDIDATES**

1. Do not turn over this page until you are told to do so.
2. Follow all instructions carefully.
3. Answer all questions.

Name: \_\_\_\_\_ (     )

Class: Primary 6 (     )

Date: 25 August 2020

Total Time: 1 h 45 min

Marks for Booklet B: \_\_\_\_\_



**Booklet B (44 marks)**

Write your answers to questions 29 to 41 in the spaces given.

29. Shawn conducted an experiment as shown below.

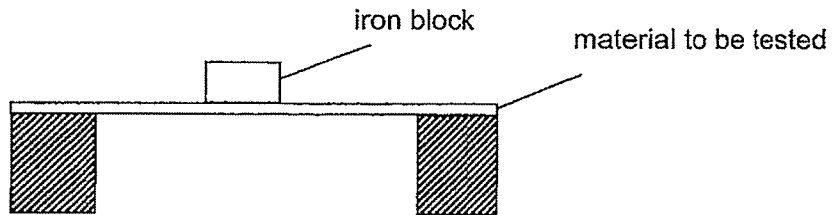

He tested four materials, W, X, Y and Z, separately by placing iron blocks, each weighing 1 kg, on each material until it broke.

He recorded the results of his experiment in the table below.

Material	Number of iron blocks that caused the material to break
W	8
X	12
Y	15
Z	5

(a) Which property of the materials was Shawn testing?

[1]

The diagram below shows a bumper car in an amusement park. The cars will bump into one another at part Q.

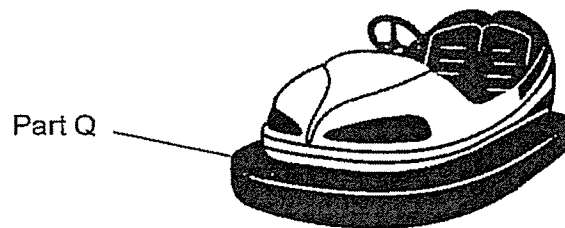

(b) Which material, W, X, Y or Z, is the most suitable for making part Q of the bumper car? Give a reason for your choice of answer.

[2]



30. The diagrams show a cockroach and its life cycle.

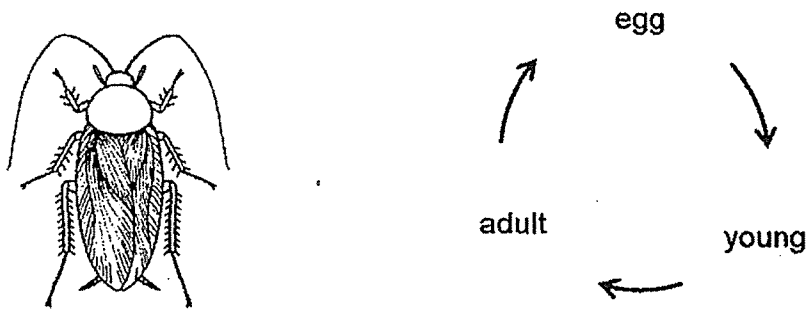

(a) The cockroach lays many eggs at a time.

Explain how this helps the cockroach in the continuation of its kind.

[1]

---

---

(b) The diagram below shows the life cycle of insect X.

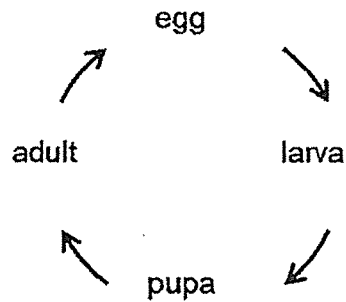

Benny compared the life cycle of the cockroach and that of insect X.

Other than the number of stages in the life cycle, state another difference between the life cycles of the cockroach and insect X.

[1]

---

---



31. The graphs show the change in the mass of four different types of food, A, B, C and D, in different parts of the digestive system.

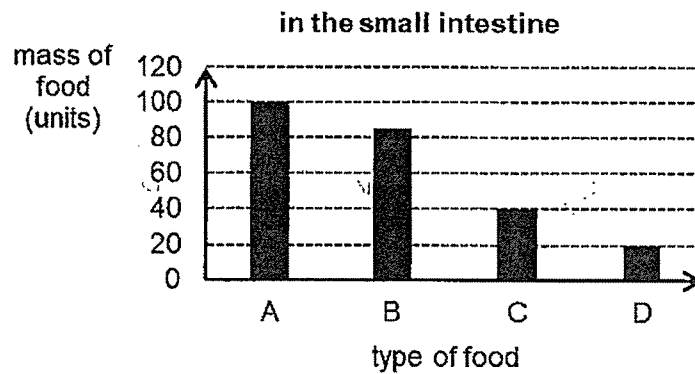
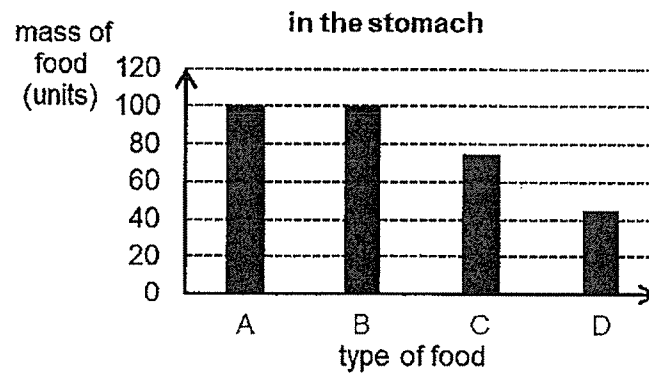
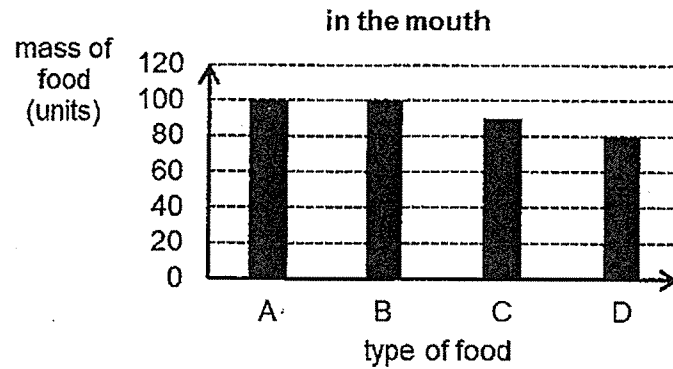

- (a) Based on the graphs, which type of food is digested only in the small intestine? [1]

---

- (b) Describe what happens to the digested food in the small intestine. [1]

---



32. Henry placed four plants in identical jars, each containing water at the same level of 250 mm as shown below. He then placed the four set-ups, A, B, C and D, next to the window for three hours.

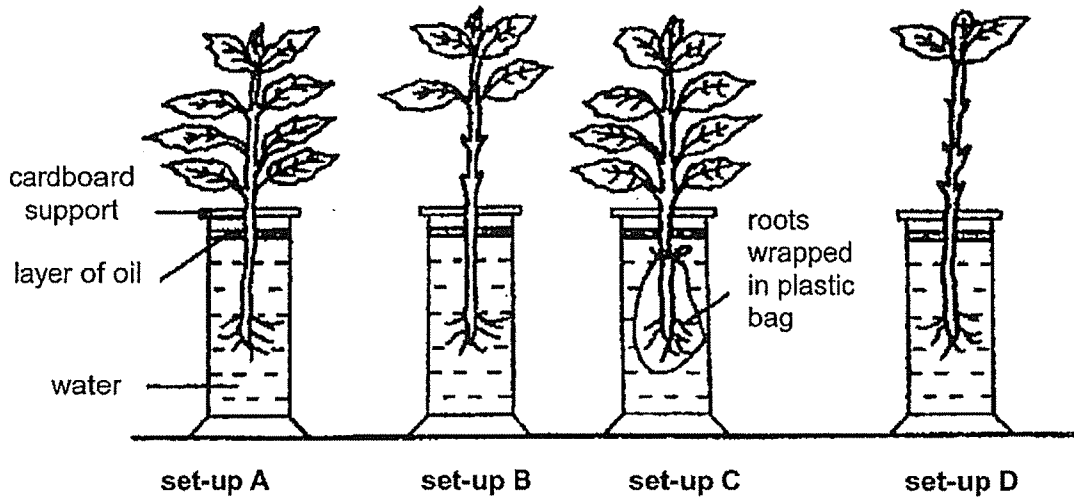

At the end of the experiment, Henry measured the height of water in each jar. He found the height to be 250 mm, 245 mm, 240 mm and 230 mm.

- (a) Write 'A, B, C and D' in the boxes below to show the correct results of the experiment for each set-up. [1]

Height of water at start of experiment (mm)	250	250	250	250
Height of water at end of experiment (mm)	250	245	240	230
set-up	<input type="checkbox"/>	<input type="checkbox"/>	<input type="checkbox"/>	<input type="checkbox"/>

- (b) If Henry wanted to show that the roots of the plants take in water, which two set-ups should he compare? [1]

- (c) Based on your answer in (b), which set-up serves as a control? Give a reason for your choice. [1]





33. The diagram below shows a plant while the arrows represent part of the transport system found in the plant.

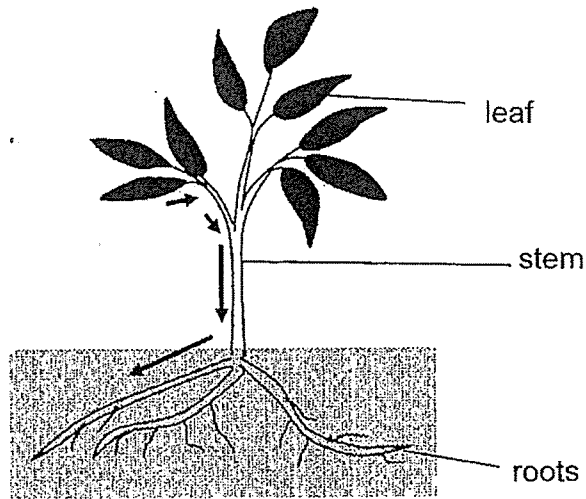

- (a) Identify the type of tubes in the transport system represented by the arrows and describe its function in the plant. [2]

(i) Type of tubes: \_\_\_\_\_

(ii) Function: \_\_\_\_\_

\_\_\_\_\_

\_\_\_\_\_

- (b) Besides absorbing water and mineral salts, state another function of the roots in the plant. [1]

\_\_\_\_\_

\_\_\_\_\_

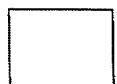

34. The diagrams below show two fruits, X and Y, which disperse their seeds when they split open.

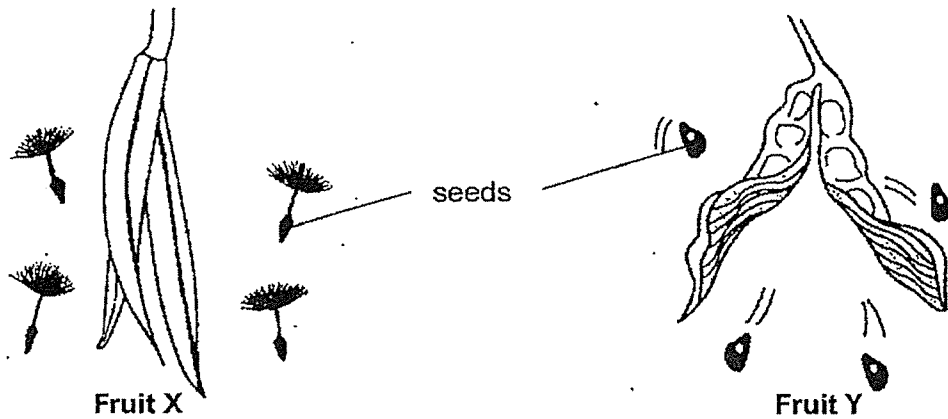

- (a) Based on the diagrams, which fruit, X or Y, is more likely to disperse its seeds further away from its parent plant? Explain your answer. [1]

---



---

- (b) The diagrams below show flowers S and T from two different plants.

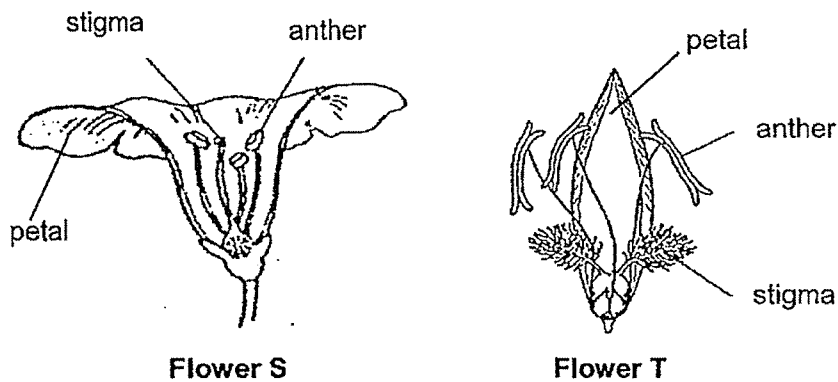

- Based on the diagrams, which flower, S or T, is likely to have its flower pollinated by an animal? Give two reasons for your answer.

[2]

Animal-pollinated flower: \_\_\_\_\_

Reason 1:

---

Reason 2:

---



35. Mark conducted an experiment with the set-up shown below.

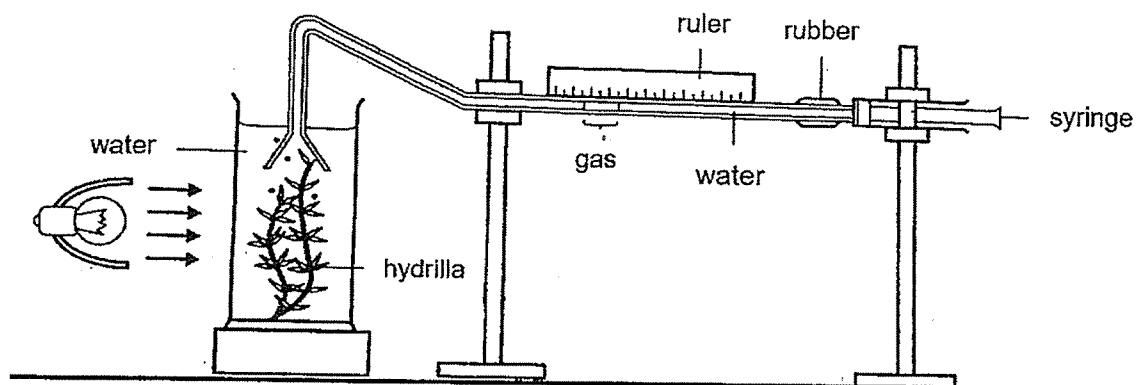

He recorded his observation in the table below.

Distance of lamp from hydrilla (cm)	Length of gas column produced in 5 minutes (mm)
10	14
35	12
75	9
100	7
150	4
200	1
250	0

(a) Identify the independent and dependent variable in Mark's experiment.

[1]

Independent variable: \_\_\_\_\_

Dependent variable: \_\_\_\_\_



Question 35 continued

- (b) How does the length of the gas column change with the distance of the lamp from the hydrilla? [1]

---

---

- (c) Explain your answer in (b). [1]

---

---

Using the same set-up, Mark conducted a second experiment using two different water plants, X and Y. He plotted the results as shown in the graphs below.

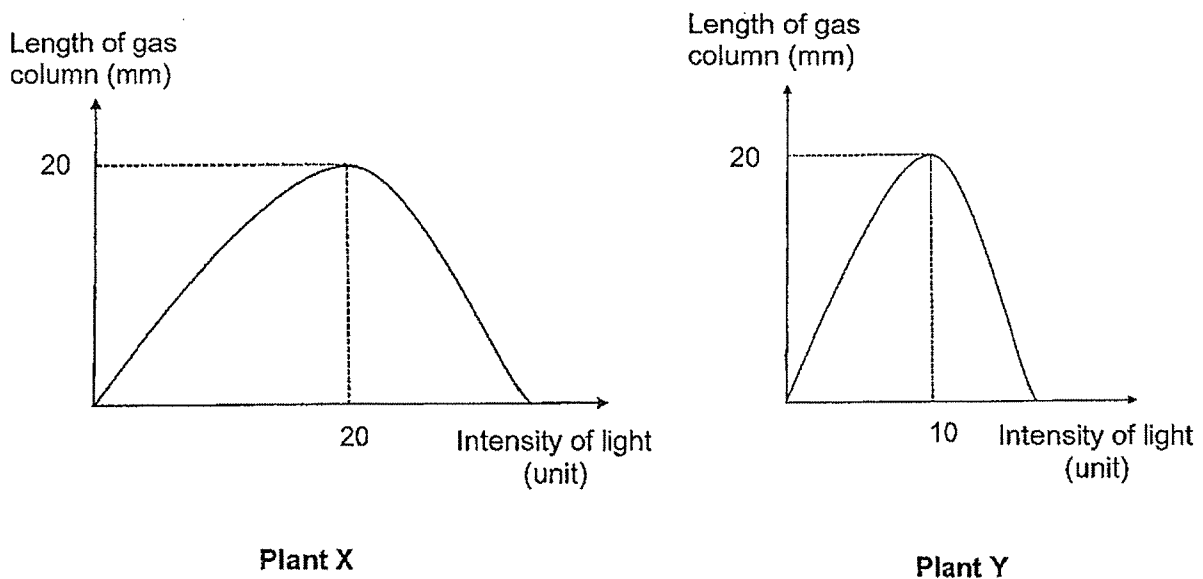

- (d) Based on the results of his second experiment, which water plant, X or Y, should be placed in the shady part of his pond? Explain your answer. [2]

---

---

---



36. Jun Jie conducted an experiment by placing a syringe filled with air between two pieces of wooden plank as shown below. As he added identical boxes, one at a time, onto the piece of wooden plank above the syringe, he measured the volume of air trapped in the syringe.

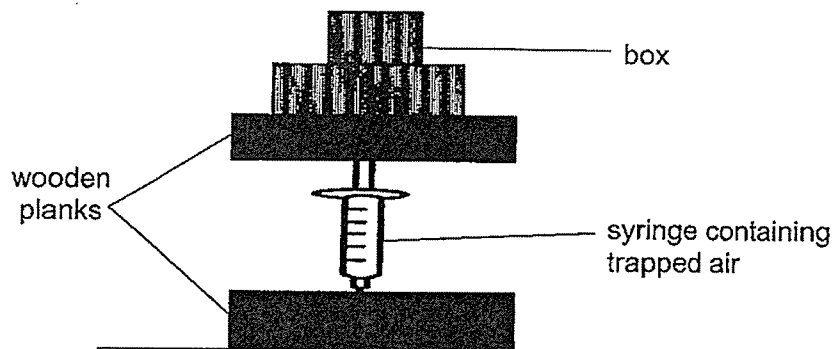

Jun Jie recorded the volume of the air trapped in the syringe in the table below.

Number of boxes added	0	1	2	3	4	5
Volume of the air trapped in syringe (cm <sup>3</sup> )	100	60	50	35	30	27

- (a) The volume of air trapped in the syringe decreased as more boxes were added onto the plank above the syringe. State the property of air which explains this observation. [1]

---



---

- (b) The mass of air trapped in the syringe was 4.8 g when one box was placed onto the wooden plank above the syringe.

State the mass of air trapped in the syringe when 4 boxes are added.

Explain your answer.

[2]

---



---



37. Tom conducted an investigation using three different types of mammals, P, Q and R. For each type of mammal, he used 5 animals. He measured the length of fur and the amount of air trapped by their coat of fur.

He plotted the results of his investigation in the diagram below. Each symbol represents one type of mammal.

Amount of air trapped ( $\text{cm}^3$ )

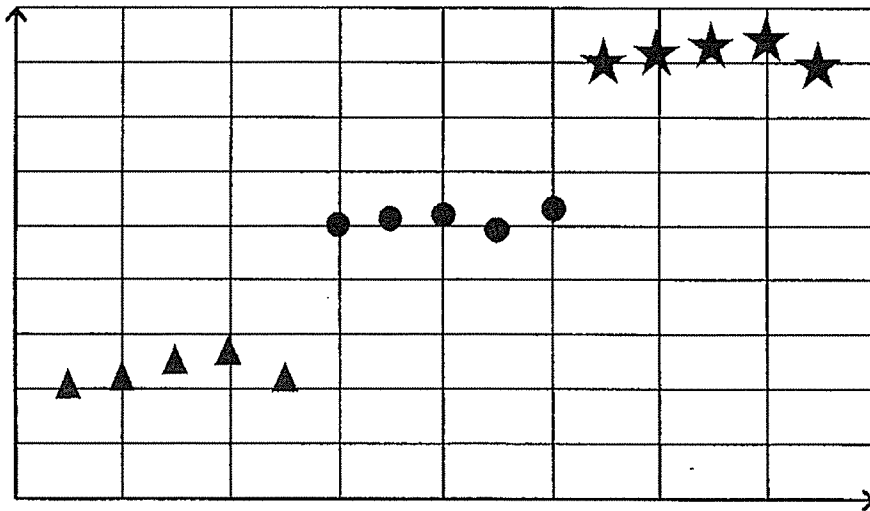

Length of fur (cm)

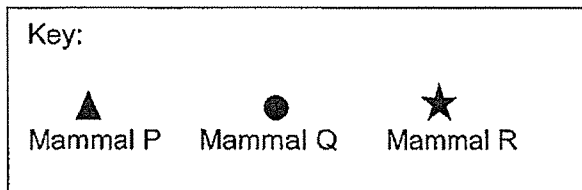

- (a) How does trapping air enable mammals to keep themselves warm? [2]

---



---

- (b) Based on the results of his investigation, which mammal, P, Q or R, has fur that is best for making winter clothes? [1]

---

- (c) Explain your answer in (b). [2]

---



---



---

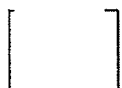

38. Siti boiled a pot of water and observed that substances X and Y were formed as shown in the diagram below.

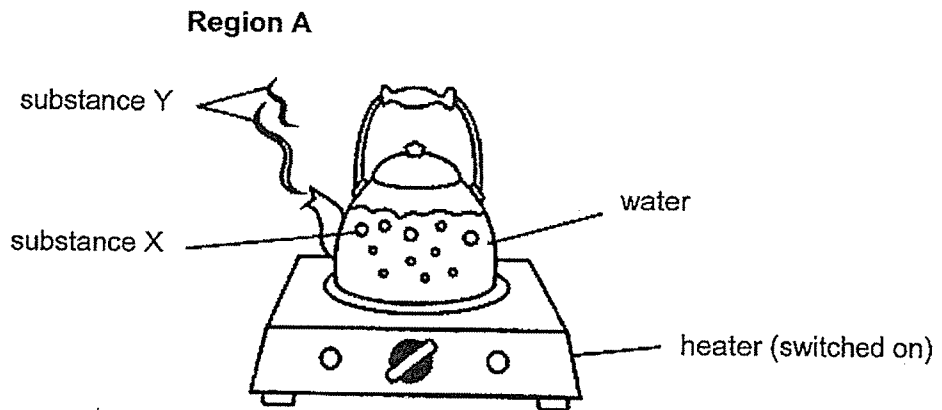

- (a) Identify the state of substances X and Y. [1]

Substance X: \_\_\_\_\_

Substance Y: \_\_\_\_\_

- (b) Describe how substance Y is formed. [2]

---

---

---

- (c) Siti observed that substance Y could no longer be seen beyond region A. Explain her observation. [1]

---

---



39. Two teams of pupils, A and B, were given some items to set up an electric circuit during a competition. The teams had to use **all** the items given to form their circuit.

Each team was given the following items:

- 1 battery
- 2 identical bulbs
- 1 switch
- some wires

At the end of the competition, team B's bulbs were brighter than team A's.

- (a) Draw the two circuit diagrams formed by teams A and B respectively during the competition. [2]

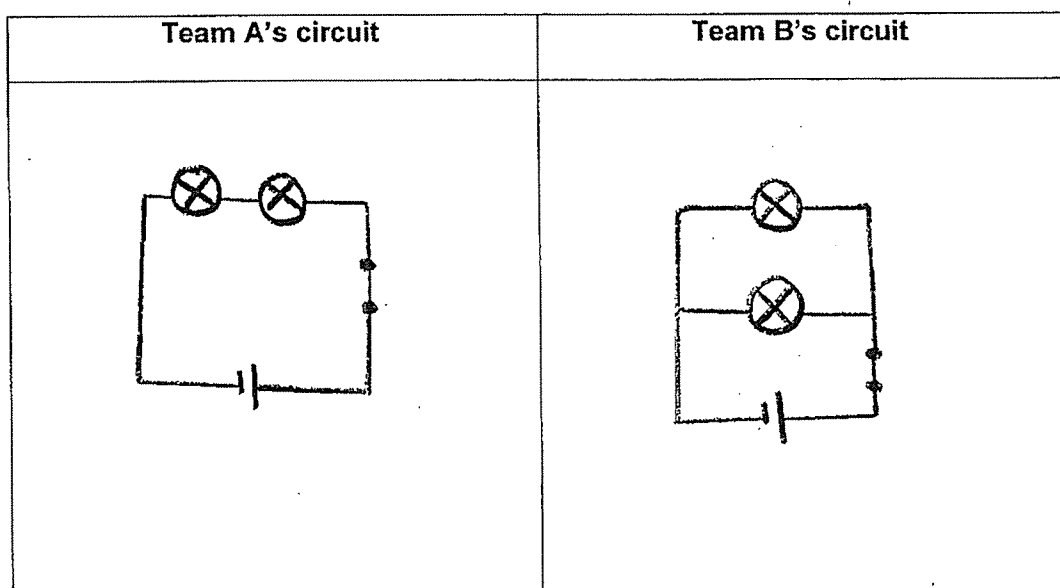





40. Raju carried out an investigation to see how high a basketball can bounce when it was dropped from different heights as shown below.

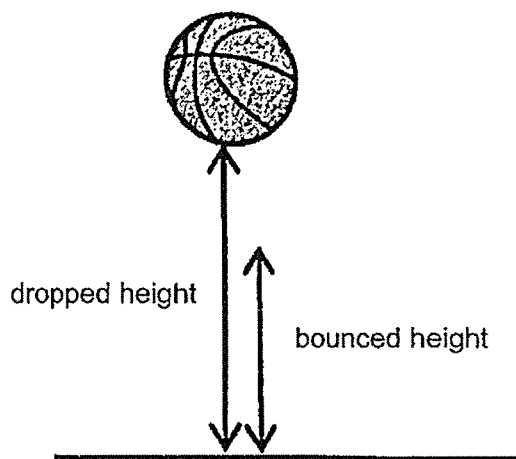

He recorded his findings in the table below.

<b>Dropped height (cm)</b>	30	50	70	90	110
<b>Bounced height (cm)</b>	22	45	57	78	100

- (a) Raju observed that the bounced height is always lower than the dropped height. Give a reason for Raju's observation. [1]

---



---

Raju also measured the loudness of the sound made when the ball first bounced on the ground. The table below shows his measurements.

<b>Dropped height (cm)</b>	30	50	70	90	110
<b>Loudness of first bounce (unit)</b>	100	130	165	190	225

- (b) Using energy conversion, explain how the loudness of the first bounce is affected by the height from which the ball was dropped. [2]

---



---



---



41. Ming was pulling a box filled with books along the floor as shown below.

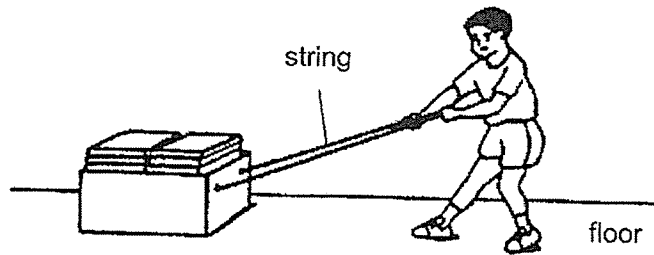

(a) Name the force that caused Ming to find difficulty in pulling the box. [1]

---

(b) Besides causing difficulty in pulling the box, what is another problem that the force mentioned in (a) may cause to the box? [1]

---

(c) State how the force mentioned in (a) can also be useful to Ming in pulling the box. [1]

---

The diagram below shows animal S which crawls on its soft foot. The underside of its foot produces a slimy substance

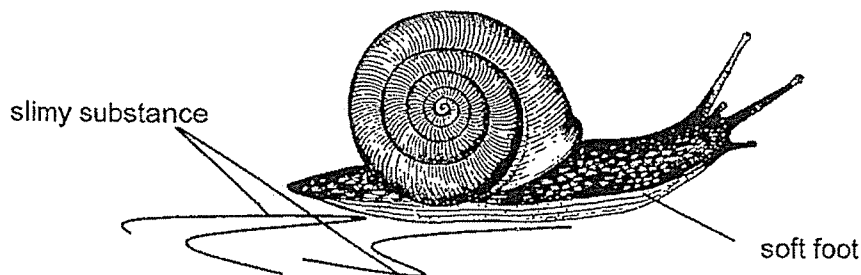

(d) Explain how the slimy substance helps animal S to move on the ground. [1]

---

---

End of Booklet B



SCHOOL : HENRY PARK PRIMARY SCHOOL  
LEVEL : PRIMARY 6  
SUBJECT : SCIENCE  
TERM : 2020 PERLIM

---

**SECTION A**

Q 1	Q2	Q3	Q4	Q5	Q6	Q7	Q8	Q9	Q10
1	3	1	2	2	1	1	4	4	3
Q 11	Q12	Q13	Q14	Q15	Q16	Q17	Q18	Q19	Q20
2	4	3	4	3	2	1	2	3	1
Q 21	Q22	Q23	Q24	Q25	Q26	Q27	Q28		
1	2	3	4	3	3	3	4		

## 2020 Science Prelims

### Suggested Answers

QN	Suggested answer
29a	strength
29b	Material Y (C). It takes the most number of blocks to break it (E). Y is the strongest so does not break easily when other cars knock into part Q (R).
30a	It increases the chance of more young growing into adult (to reproduce).
30b	The young of the cockroach looks like the adult but the young of insect X does not look like the adult.
31a	B
31b	Digested food is absorbed into the bloodstream.
32a	C, D, B, A
32b	A and C
32c	Set-up C. The roots are wrapped in plastic bag to prevent them from taking in water.
33a(i)	Food-carrying tubes
33a(ii)	They transport food made in the leaves to the roots / other plant parts.
33b	The roots help to hold the plant firmly to the soil.
34a	Fruit X. The seeds have fine hair-like parts that allow them to be carried away by wind.
34b	Flower S. Reason 1: It has large petals. Reason 2: The anthers and stigma do not hang outside the flower.
35a	Independent variable: distance between light and plant Dependent variable: length of gas column produced in 5 minutes
35b	As the distance between the light and plant increases, the length of the gas column decreases.
35c	As the distance between the light and plant increases, the light intensity decreases, thus the rate of photosynthesis decreases.
35d	Plant Y. The length of the gas column reaches 20mm at a lower light intensity. Thus, at the shady part of the pond, plant Y can still make enough food.

