



NAN HUA PRIMARY SCHOOL  
SEMESTRAL ASSESSMENT 2 – 2013  
PRIMARY 4

SCIENCE

BOOKLET A

30 Multiple Choice Questions (60 marks)

Total Time for Booklets A and B : 1 hour 45 minutes

INSTRUCTIONS TO CANDIDATES

1. Write your name and index number in the space provided.
2. Do not turn over the page until you are told to do so.
3. Follow all instructions carefully.
4. Answer all questions.
5. Shade your answers in the Optical Answer Sheet (OAS) provided.

**Marks Obtained**

Booklet A		/ 60
Booklet B		/ 40
Total		/100

Name: \_\_\_\_\_ ( )

Class: P 4 \_\_\_\_\_

Date : 28 October 2013

Parent's Signature: \_\_\_\_\_

---

**Section A: (30 x 2 marks = 60 marks)**

For each question from 1 to 30, four options are given. One of them is the correct answer. Make your choice (1, 2, 3 or 4). Shade the correct oval (1, 2, 3 or 4) on the Optical Answer Sheet.

1. Which one of the following is a non-living thing?



(1)



(2)



(3)

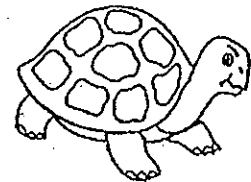

(4)

2. The table below shows how some living things can be grouped.

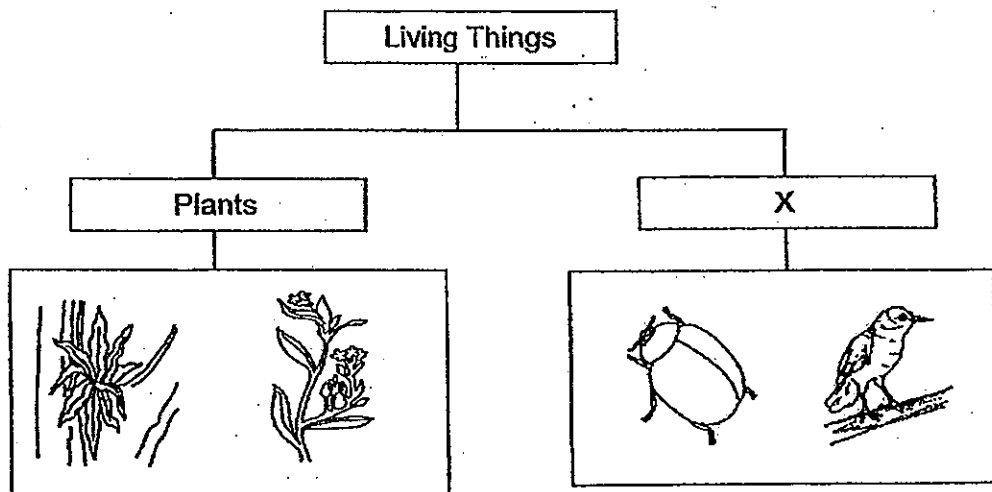

Which one of the following is the most suitable heading for group X?

- (1) Animals
- (2) Birds
- (3) Fungi
- (4) Mammals

3. The diagram below shows some books on a bookshelf.

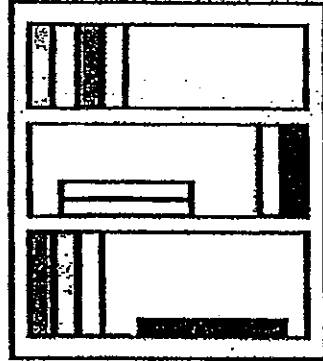

Wood is used to make the bookshelf because wood \_\_\_\_\_.

- (1) is strong
- (2) is flexible
- (3) is opaque
- (4) floats on water

4. The picture below shows a hibiscus plant.

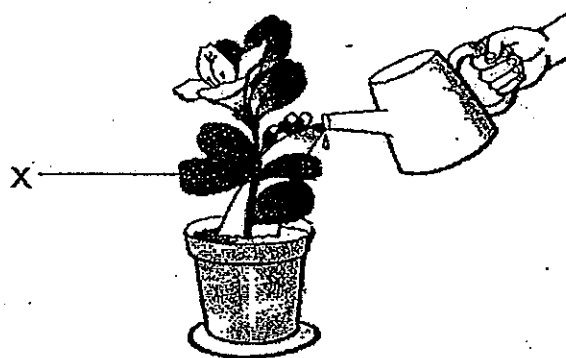

Part X helps the plant to \_\_\_\_\_.

- (1) make food
- (2) grow upright
- (3) absorb water
- (4) absorb nutrient

5. The picture below shows a stomach which is part of our digestive system.

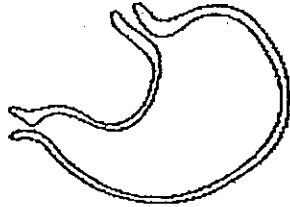

stomach

Which organ does the food travel to when it leaves the stomach?

- (1) gullet
  - (2) mouth
  - (3) large intestine
  - (4) small intestine
6. Which one of the following objects can be attracted by a magnet?

(1) a gold coin

(2) a steel can



(3) a plastic knife

(4) a rubber ball

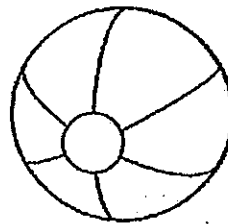
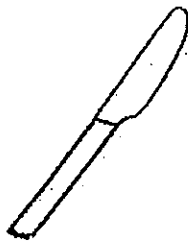

7. Which one of the following is a source of light?

(1) a box

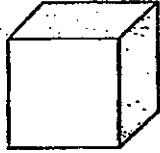

(2) a candle



(3) the moon

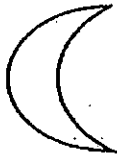

(4) the star



8. Mary wants to measure the temperature of hot water in a beaker.

Which one of the following diagrams shows the correct position of the thermometer when taking the temperature reading?

(1)

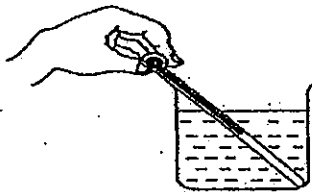

(2)

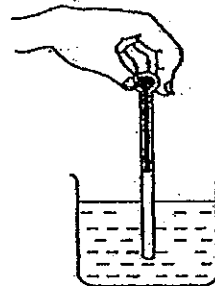

(3)

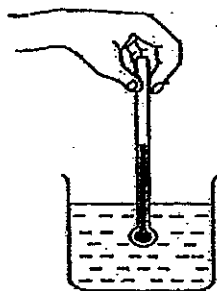

(4)

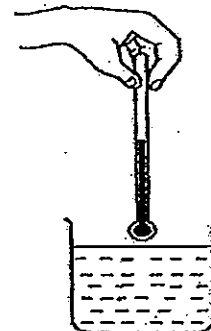

9. The diagram below shows the life cycle of an animal.

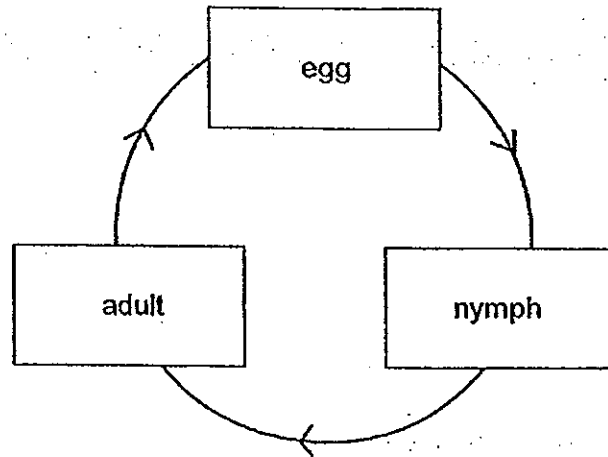

Which animal is likely to have a life cycle as shown above?

- (1) frog
  - (2) beetle
  - (3) butterfly
  - (4) cockroach
10. Matter is anything that has mass and occupies space.

Which one of the following is **NOT** matter?

- (1) air
- (2) book
- (3) flower
- (4) sunlight

11. Charlie conducted an experiment on a type of organism. He placed 60 of these similar organisms equally in 3 setups.

Setup	Number of organisms	Amount of food given per day (grams)	Amount of water given per day (ml)
A	20	250	200
B	20	250	400
C	20	250	800

After a week, he observed the number of organism that is alive in each setup. What was the aim of Charlie's experiment?

He wanted to find out \_\_\_\_\_ affects the number of organisms that are alive in the setup after a week.

- (1) if the presence of water
- (2) if the presence of food and water
- (3) how the amount of water given per day
- (4) how the amount of food and water given per day

12. Plants A, B, C and D have common characteristics as shown in the table below. A tick (✓) shows the presence of the characteristic of the plant.

Characteristics	Plant A	Plant B	Plant C	Plant D
Grow on land	✓	✓		
Reproduce from spores.	✓			✓

Based on the given information above, which letters, P, Q, R and S, in the chart below best represent plant B?

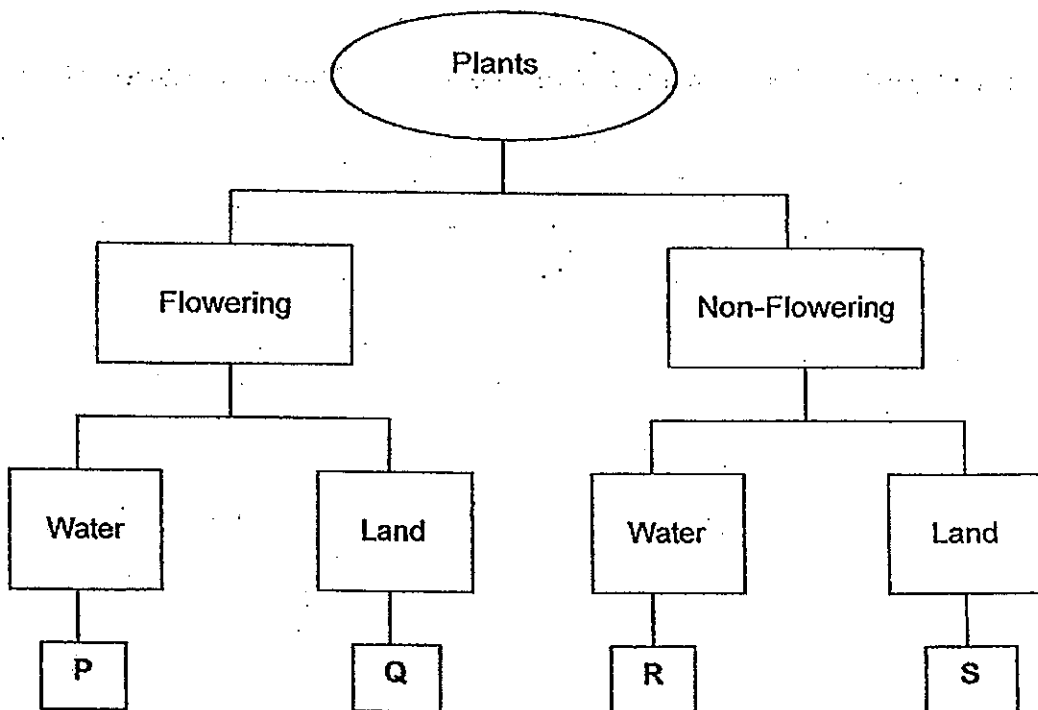

- (1) Letter P
- (2) Letter Q
- (3) Letter R
- (4) Letter S



13. Tom used an iron nail to conduct a scratch test to compare the hardness of three different materials, W, X and Y. He recorded his observations in the table below.

Material	X	Y	W
Presence of scratches	hardly any scratches	some scratches	a lot of scratches

Which one of the following conclusions is correct?

- (1) Material X is the softest.
- (2) Material W is the hardest.
- (3) Material X is softer than material Y.
- (4) Material Y is harder than material W.

14. Which of the following is not a function of roots?

- (1) Roots take in water
- (2) Roots take in sunlight.
- (3) Roots take in mineral salts.
- (4) Roots anchor the plant firmly to the ground.

15. The diagram below shows the dentures of Mrs Chin.

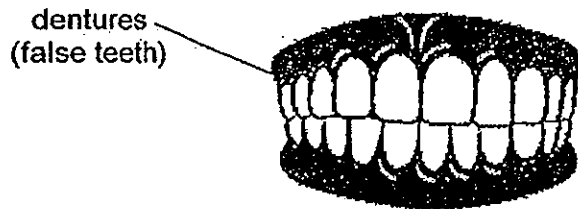

How are the dentures useful to her?

- (1) The dentures digest her food.
  - (2) The dentures push down the food into her gullet.
  - (3) The dentures release digestive juices into her mouth.
  - (4) The dentures break the food she eats into smaller pieces.
16. The diagram below shows a horseshoe magnet with different parts labelled A, B, C and D.

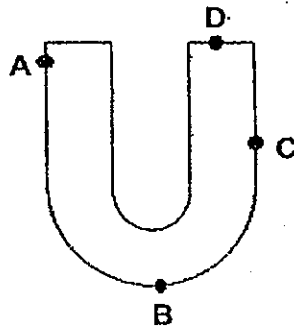

Which of the following best represents the number of iron nails that these parts will attract?

	A	B	C	D
(1)	6	1	4	8
(2)	9	2	7	1
(3)	8	5	2	6
(4)	2	8	5	1

17. Jane was given 4 boxes, each containing a mixture of two different types of items. In which box would Jane be able to separate the items successfully using a magnet?

(1)

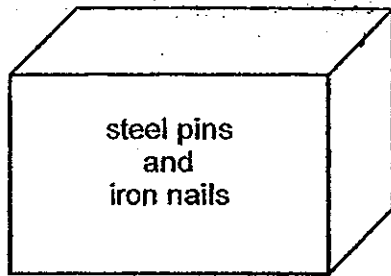

(2)

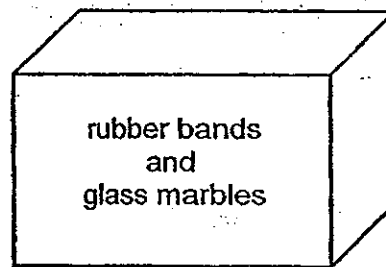

(3)

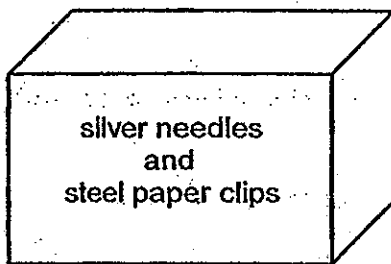

(4)

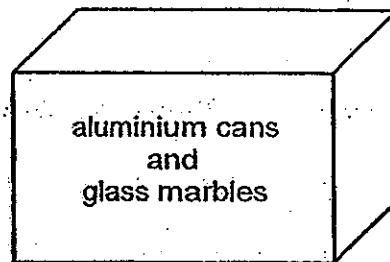

18. Which of the following statements are true of light?

- (1) Light rays can travel in all directions.
- (2) Light is able to bend around an object.
- (3) Light cannot pass through translucent objects.
- (4) Only objects with smooth surfaces can reflect light.

19. Vicky set up an experiment as shown below.

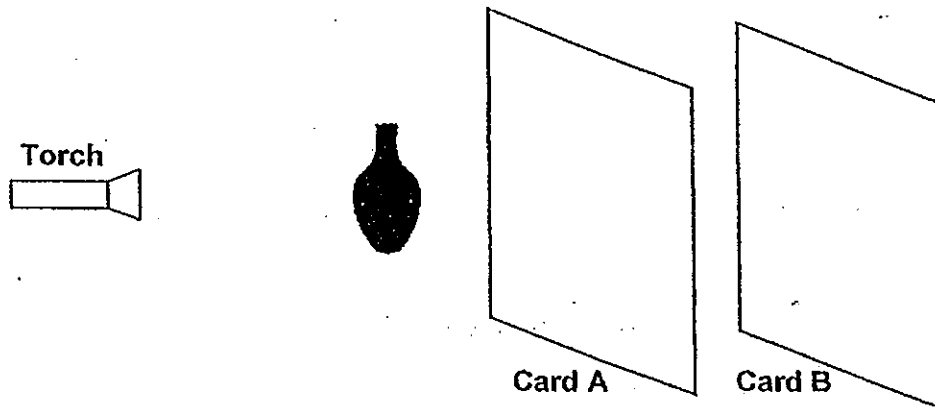

What materials should Vicky use for Card A and Card B if she wants the torch to successfully cast a dark shadow of the ceramic vase on card B?

	Card A	Card B
(1)	frosted glass	opaque cardboard
(2)	clear glass	translucent plastic
(3)	black cardboard	transparent glass
(4)	clear plastic	opaque plastic

20. The diagram below shows four unlit torches, A, B, C and D, pointing at a toy soldier.

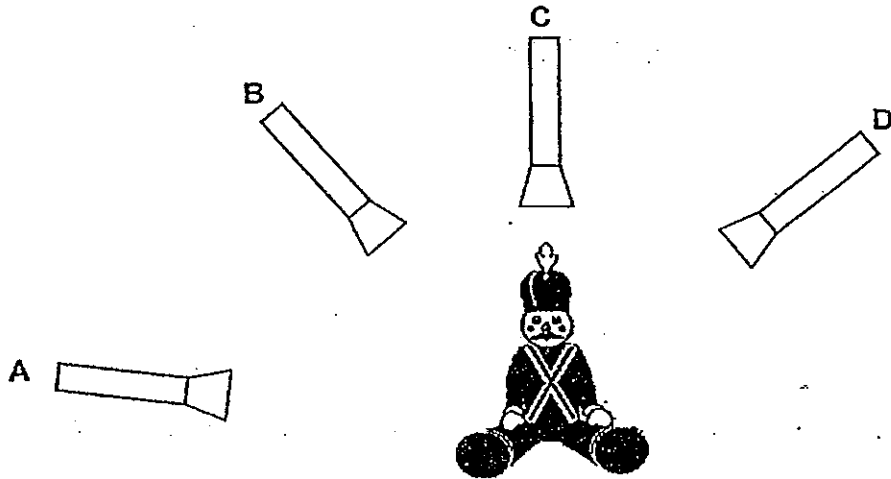

Joe switched on the torch one by one and recorded the length of the shadow cast by the toy using each torch. Which of the following observations is correct?

	Length of shadow cast using torch A (cm)	Length of shadow cast using torch B (cm)	Length of shadow cast using torch C (cm)	Length of shadow cast using torch D (cm)
(1)	5	13	18	12
(2)	15	11	5	12
(3)	5	12	15	18
(4)	11	13	5	15

21. David poured all the water from container A and container B into a basin.

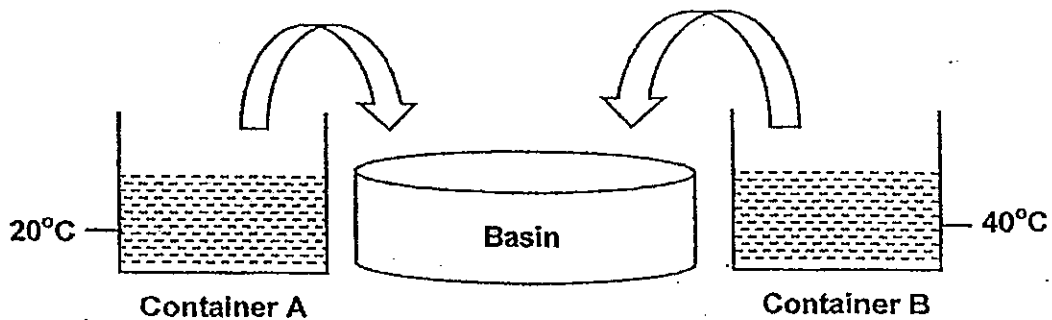

What would be the temperature of the water in the basin?

- (1) 20°C
  - (2) 30°C
  - (3) 40°C
  - (4) 60°C
22. The alcohol level of a laboratory thermometer drops when it is placed in a beaker of ice. Why does the alcohol level drop?
- (1) The alcohol loses heat to the ice and contracts.
  - (2) The thermometer loses heat to the ice and contracts.
  - (3) The alcohol gains coldness from the ice and contracts.
  - (4) The thermometer gains heat from the ice and expands.

23. William wanted to find out if the material of three cups A, B and C, affects the temperature of the water. He prepared 3 setups as shown below and placed them on a bench in his garden which was exposed to direct sunlight.

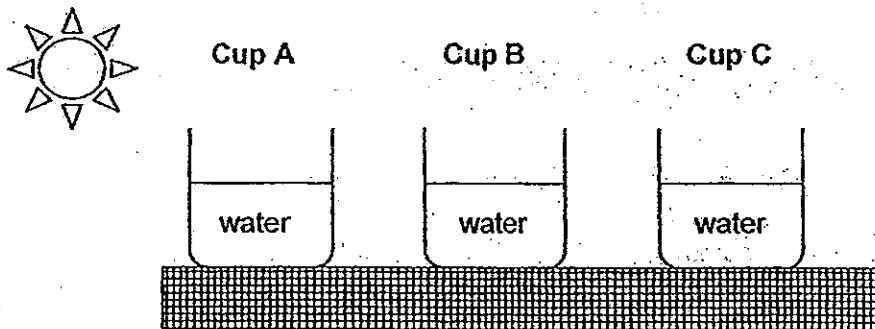

What are the variables that William must keep the same in order to conduct a fair test?

- A The materials used to make the cups.
- B The amount of water poured into each cup.
- C The starting temperature of water in each cup.
- D The time taken for the water in each cup to reach the highest temperature.

- (1) A and B
- (2) A and D
- (3) B and C
- (4) C and D

24. Study the classification table below.

Group 1	Group 2
Beetle Butterfly Mosquito	Frog Chicken Cockroach

Which one of the following statements about the two groups of organisms is true?

- (1) Animals in group 1 are insects while animals in group 2 are not insects.
- (2) Animals in group 1 reproduce by laying eggs but animals in group 2 give birth to young.
- (3) Animals in group 1 have four stages in their life cycles while animals in group 2 have three stages in their life cycle.
- (4) The young of animals in group 1 have wings but the young of animals in group 2 do not have wings.

25. Which of these statements are false?

- A All plants grow only from seeds.
- B Leaves provide food for seeds to germinate.
- C All plants produce fruits which contain seeds.
- D Seeds need air, moisture and warmth to germinate.

- (1) A and C only
- (2) B and D only
- (3) A, B and C only
- (4) A, B, C and D

26. Study the chart below.

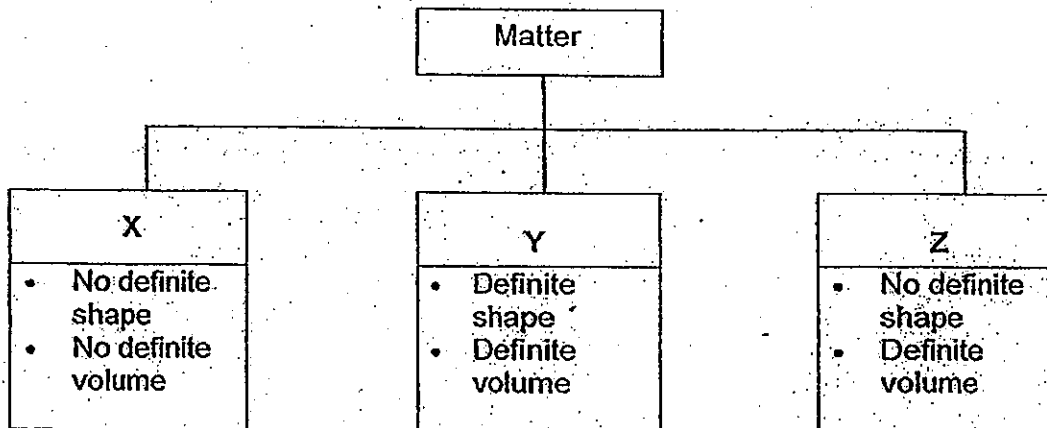

Which of the following correctly classifies clay, oil and steam?

	X	Y	Z
(1)	Oil	Clay	Steam
(2)	Steam	Oil	Clay
(3)	Oil	Steam	Clay
(4)	Steam	Clay	Oil



27. A can is filled with water up to its spout as shown below.

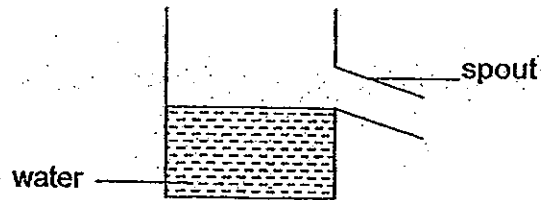

When a pebble is placed gently inside the can so that it is completely covered by the water, water flows out from the spout.

Why does the water flow out of the spout?

- (1) The pebble and the water increase in mass.
- (2) The pebble and the water increase in volume.
- (3) The pebble occupies space and the water increase in volume.
- (4) The pebble occupies space and both the water and pebble cannot occupy the same space.

28. The diagram below shows a simplified version of the Water Cycle.

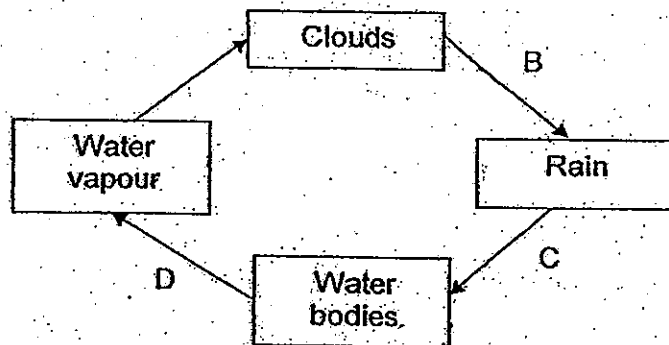

Which processes, A, B, C and/or D, involve(s) a change in the state of water?

- (1) A only
- (2) A and D only
- (3) C and D only
- (4) A, B and D only

29. Which one of the following does not help to conserve water?

- (1) Repair leaks and dripping taps immediately.
- (2) Wash vegetables and dishes in a sink filled with water.
- (3) Rinse your mouth under a running tap instead of using a tumbler.
- (4) Collect rinse water from the washing machine for flushing the toilet.

30. The graph below shows how the temperature of Substance X changed when it was heated.

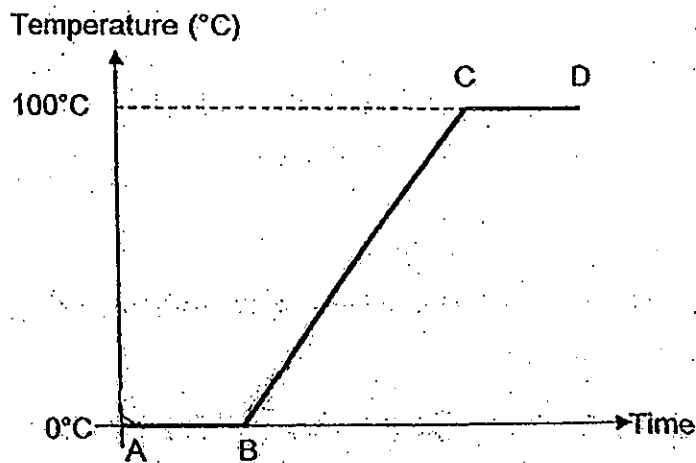

What is most likely to be happening from B to C?

- (1) Substance X is melting to become liquid.
- (2) The temperature of Substance X is decreasing.
- (3) Substance X is gaining heat from a heat source.
- (4) Substance X is boiling and changes into steam.



NAN HUA PRIMARY SCHOOL  
SEMESTRAL ASSESSMENT 2 – 2013  
PRIMARY 4

SCIENCE

BOOKLET B

14 Open-ended questions (40 marks)

Total Time for Booklets A and B : 1 hour 45 minutes

INSTRUCTIONS TO CANDIDATES

1. Write your name and index number in the space provided.
2. Do not turn over the page until you are told to do so.
3. Follow all instructions carefully.
4. Answer all questions.
5. Write your answers in this booklet.

Marks Obtained

Section B		/40
-----------	--	-----

Name: \_\_\_\_\_ ( ) Class: P 4 \_\_\_\_\_

Date : 28 October 2013

Parent's Signature: \_\_\_\_\_

---

**Section B: (40marks)**

Write your answers to question 31 to 44. The number of marks available is shown in brackets [ ] at the end of each question or part question.

31. Jane observed and grouped some living things as shown in the table.

F	G
duck	ant
eagle	mosquito
chicken	butterfly

What are the suitable headings for F and G?

[2]

Group F: \_\_\_\_\_ Group G: \_\_\_\_\_

32. The diagram below shows the human digestive system.

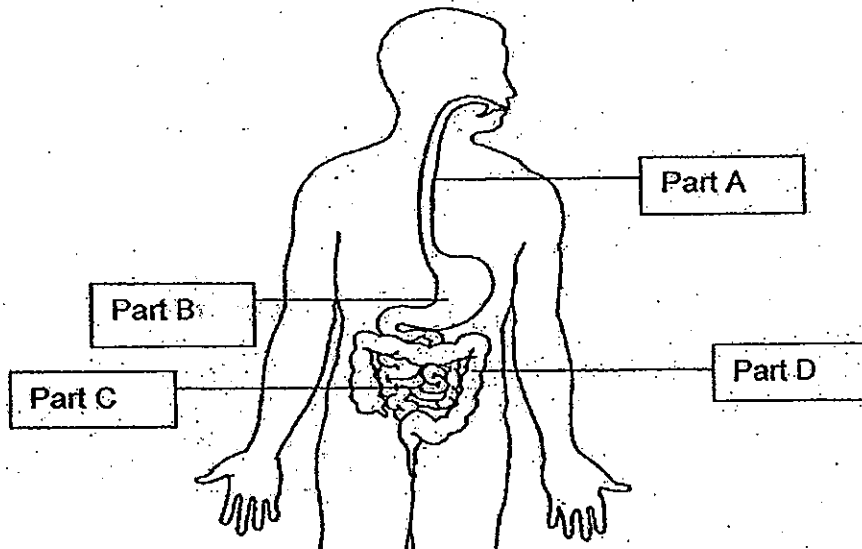

Identify the part where

a) digestion is completed: \_\_\_\_\_

[1]

b) water is absorbed into the body: \_\_\_\_\_

[1]

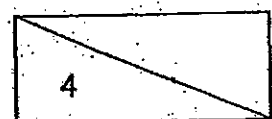

33. The diagram below shows how Celine sees the apple.

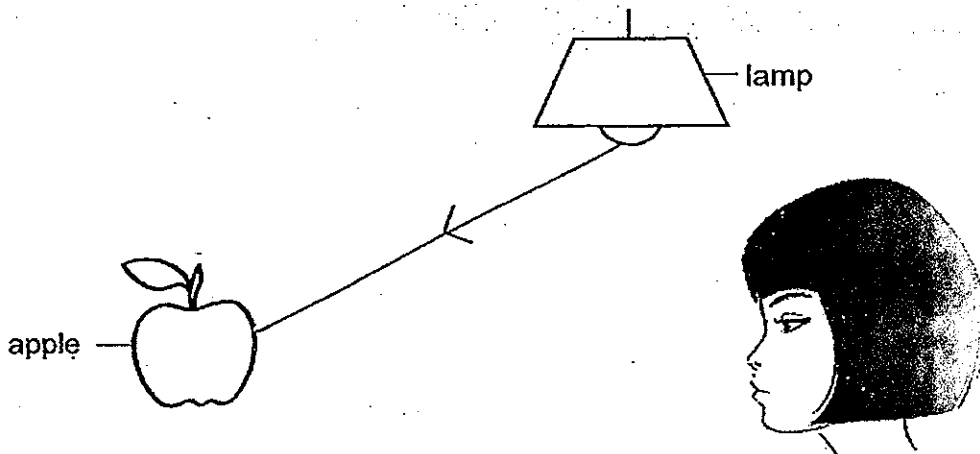

The \_\_\_\_\_ from the lamp is \_\_\_\_\_ by the apple and enters Celine's eye. [2]

34. Sean places a metal spoon in a cup of hot water.

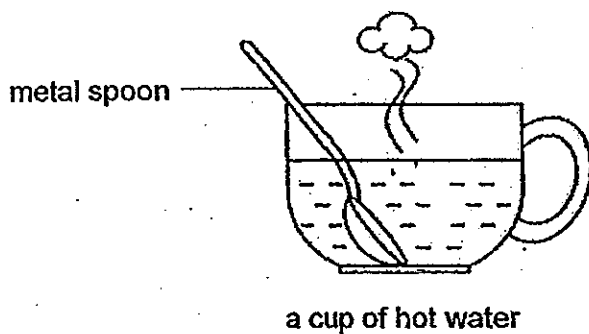

The spoon becomes warmer after a while because the hot water \_\_\_\_\_ heat to the spoon and the spoon \_\_\_\_\_ heat from the hot water. [2]

hot

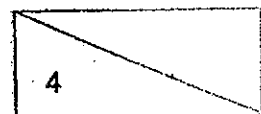

35. John compares the mass of three fruits.  
Study the diagrams below and circle the correct comparison.

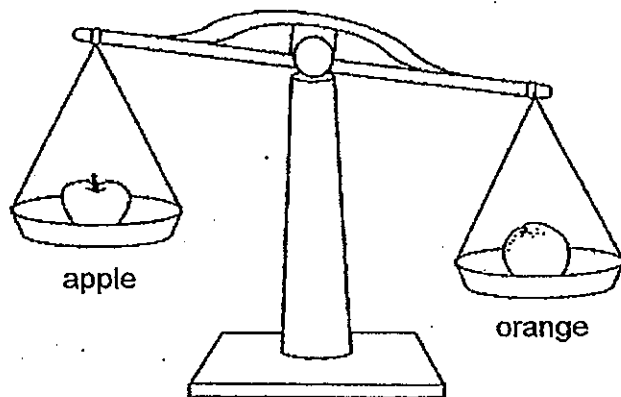

- a) The orange 'is heavier than' / 'has the same mass as' / 'is lighter than' the apple. [1]

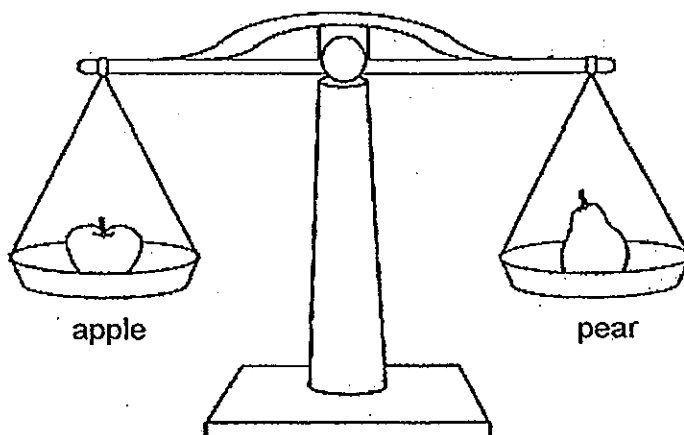

- b) The pear 'is heavier than' / 'has the same mass as' / 'is lighter than' the apple. [1]

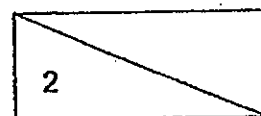

36. Kim carried out an experiment to compare the strength of string A and string B. She placed 15-gram weights on each string until each of the string broke. She recorded the results in a table as shown below.

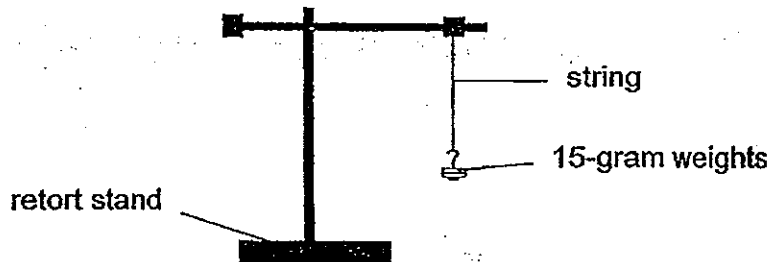

String	Number of 15-gram weights added
A	2
B	5

- a) Based on the information provided above, identify the independent variable and dependent variable of the experiment. [2]

Put a tick (✓) in the correct boxes below.

Variables	Independent variable	Dependent Variable
Type of string		
Strength of the retort stand		
Type of weights added		
Number of weights added		

- b) State one important characteristic of the two strings that must be kept the same in order to ensure a fair test. [1]

---

- c) Which string should Kim use to hang an artwork which weighs 60g? [1]

---

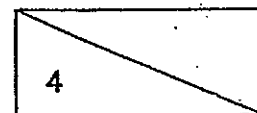

37. The diagram below shows the position of the tiny tubes found in the stem of a rose plant.

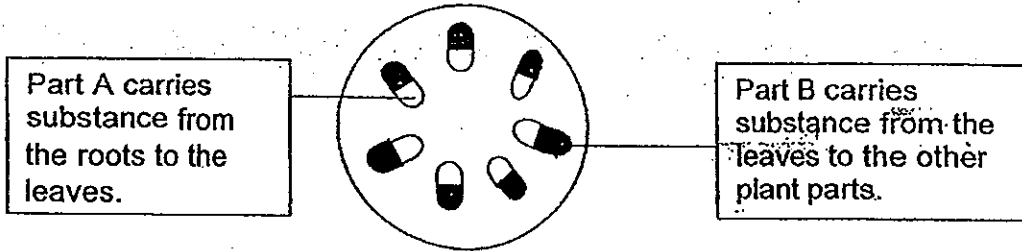

a) Name one substance carried by part A and part B. [2]

Part A: \_\_\_\_\_ Part B: \_\_\_\_\_

b) Salina found a type of insect on a plant in her garden. She observed that the insects are found mostly on the stem and leaves of the plant.

Her mother told her that the insects feed on the food that is made by the plant.

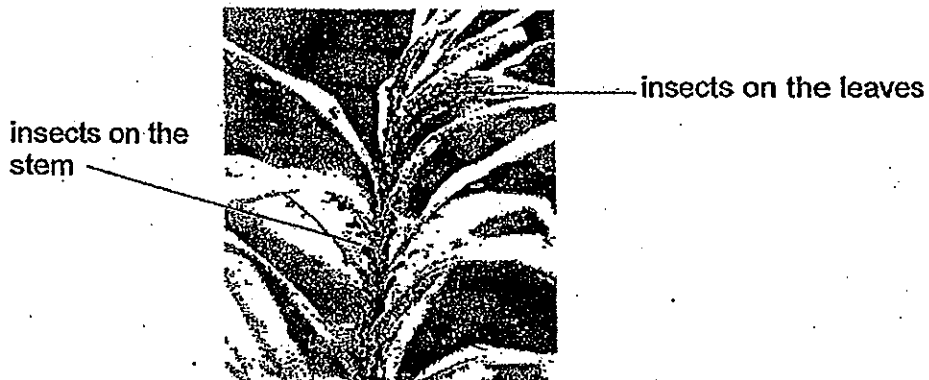

Explain why the insects are found on the stem of the plant? [1]

---



---

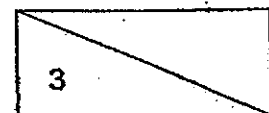



38. The table below shows <sup>three</sup> ~~three~~ different electromagnets that were set up and the number of paperclips they picked up.

Electromagnet	Number of batteries	Number of coils around the nail	Number of paperclips picked up
P	2	15	10
Q	2	30	20
R	4	15	20
S	5	15	25

a) If Jane wants to find out whether the number of batteries affects the strength of the electromagnet. Which two electromagnets can she use for comparison? [1]

---

b) What is the relationship between the number of batteries and the number of paperclips picked up by the electromagnets? [1]

---

---

c) Beside changing the number of batteries, suggest another way to increase the number of paperclips picked up by electromagnet R. [1]

---

---

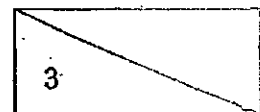

39. The diagram below shows the pupils of Newton Kindergarten watching a magic show performed by a famous magician in the school hall.

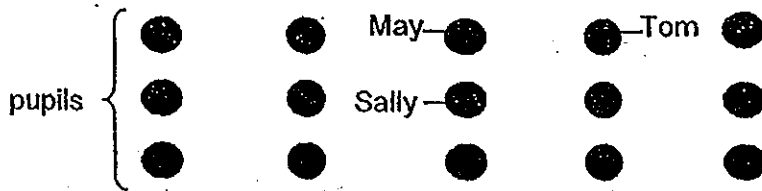
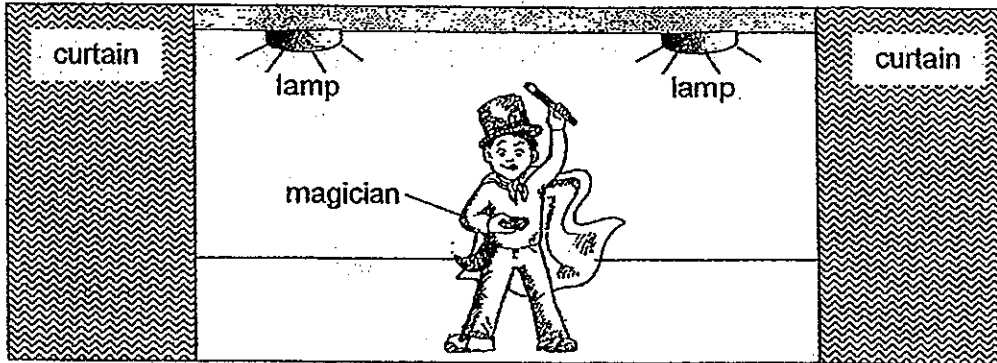

- a) Explain why Tom is able to see the magician from where he is seated. [1]

---



---

- b) Explain why Tom is not able to see the magician when the curtain is closed. [1]

---



---

- c) Sally is unable to see the magician as May is taller than her. What property of light does this show? [1]

---

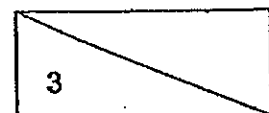

40. Muthu conducted an experiment using containers A and B, which were made of different materials. He placed container A on a floor and shone a torch at it. He observed that a dark shadow was formed on the floor. Then he repeated the experiment using container B and observed that there was a faint shadow formed on the floor.

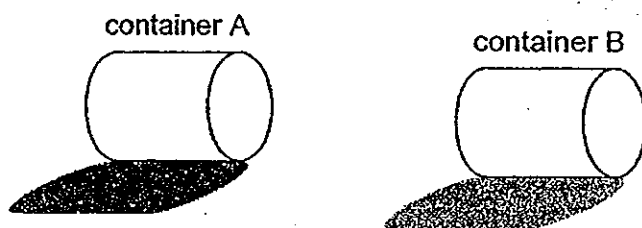

- (a) Based on the above experiment, give an example of a material used to make container A and container B. [2]

Container A: \_\_\_\_\_

Container B: \_\_\_\_\_

- (b) Explain why container A cast a dark shadow but container B cast a faint shadow. [2]

---

---

---

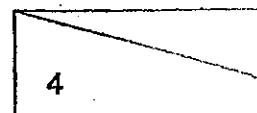

41. Mr Lee, a manager of Central Supermarket conducted an experiment to find out the amount of time taken for boiling water to lose heat and reach room temperature in three different brands of thermal flasks, A, B and C, of similar shape and size. He presented his findings in the graph below.

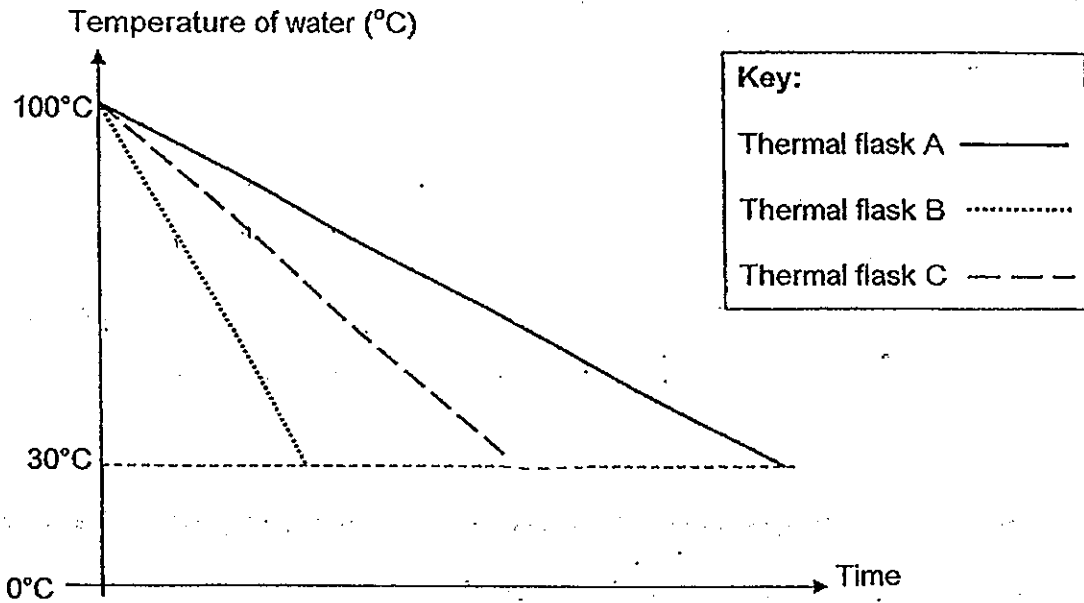

- (a) Study the graph above. Arrange the thermal flasks, A, B and C, according to their heat conductivity in the boxes below [1]

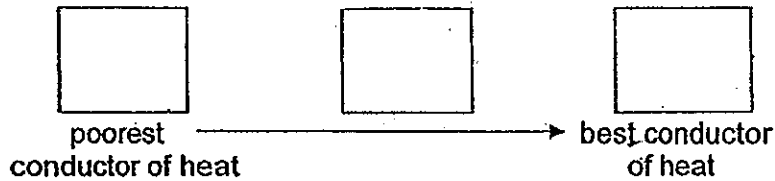

- (b) Which thermal flask, A, B or C, would Mr Lee recommend to his customers? Give a reason for your answer. [2]

---



---

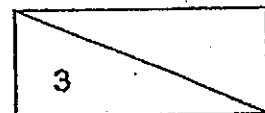

42. Study the flow chart below and answer the questions that follow.

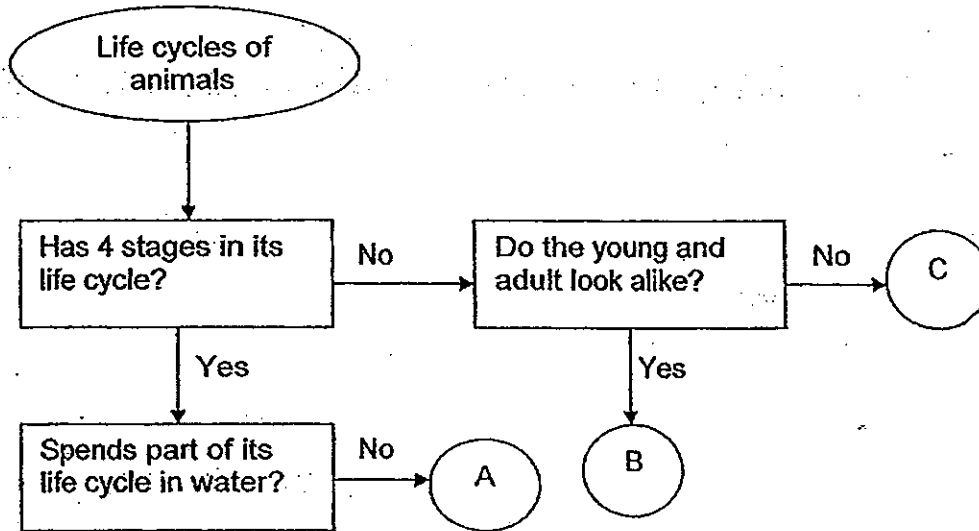

a) Based on the flow chart above, how would you describe Animal A? [2]

---

---

b) Can Animal B be a butterfly? Why? [1]

---

c) Based on the flow chart above, give an example of Animal C. [1]

---

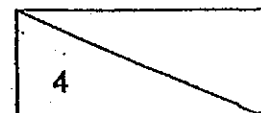

43. The table below shows the freezing point and boiling point of three different types of substance, P, Q, and R.

Substance	Freezing point ( $^{\circ}\text{C}$ )	Boiling point ( $^{\circ}\text{C}$ )
P	-15	90
Q	0	100
R	-3	120

- (a) What is the state of substance P when the temperature is  $0^{\circ}\text{C}$ ? [1]

---

- (b) State one difference between the property of substance Q and the property of substance R when the temperature is  $110^{\circ}\text{C}$  [1]

---

---

- (c) Which of the above substance, P, Q or R is pure water? Why? [1]

---

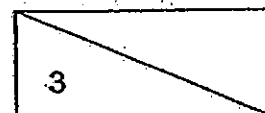

44. The diagram below shows a model of a water cycle set up by Renny to demonstrate the formation of rain. She noticed that hardly any water droplets were formed on the underside of the aluminium sheet.

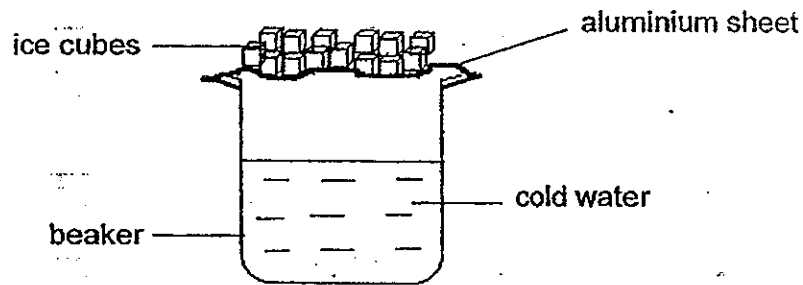

- (a) How can Renny improve her set-up so that water droplets can be formed on the underside of the aluminium sheet? [1]

---

---

- (b) Explain how the improved set-up will enable Renny to observe water droplets forming on the underside of the aluminium sheet. [2]

---

---

---

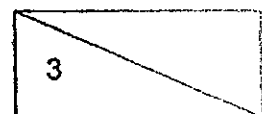

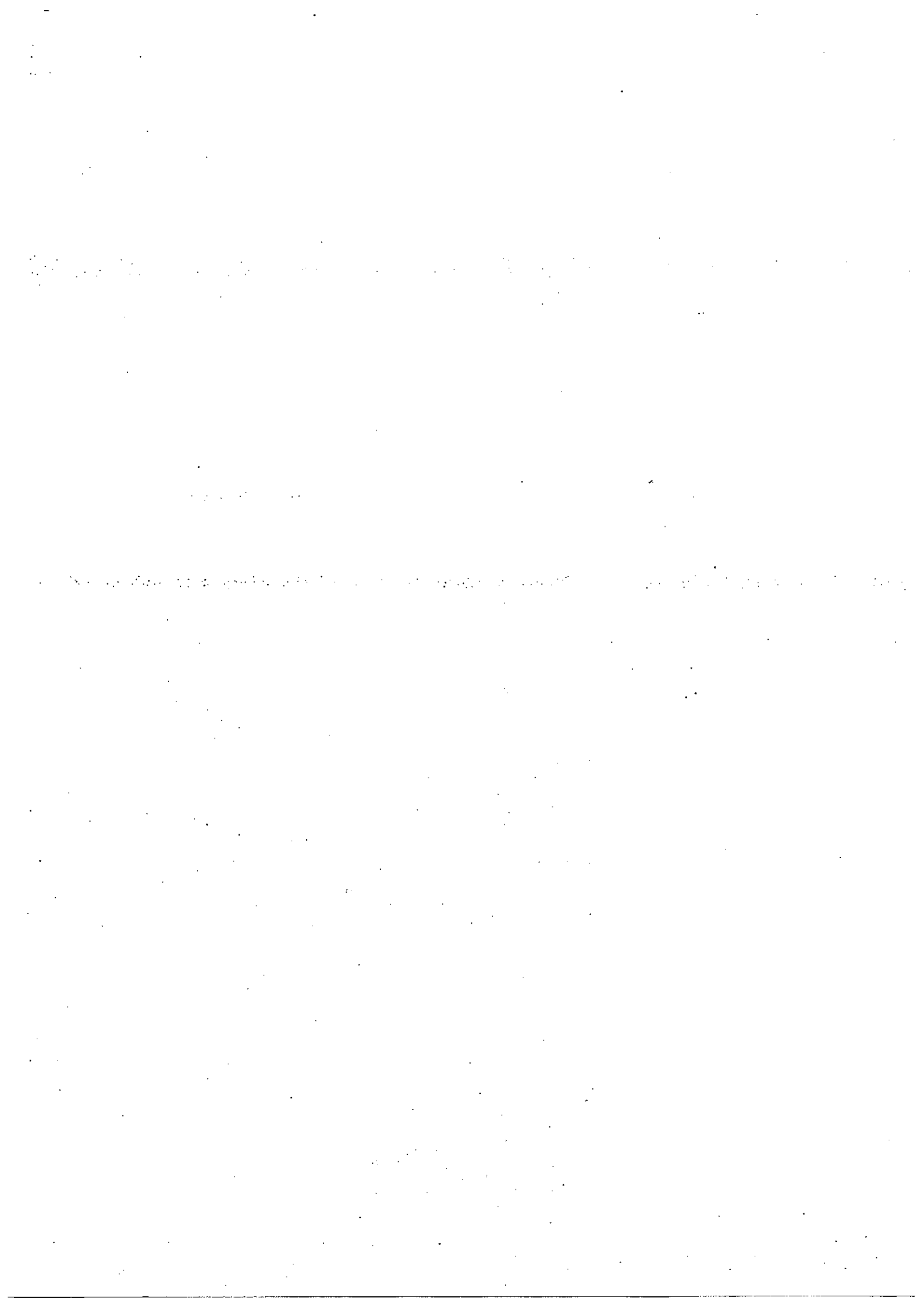



# ANSWER SHEET

**EXAM PAPER 2013**

**SCHOOL : NAN HUA**

**SUBJECT : PRIMARY 4 SCIENCE**

**TERM : SA2**

## Section A

Q1	Q2	Q3	Q4	Q5	Q6	Q7	Q8	Q9	Q10	Q11	Q12	Q13	Q14	Q15	Q16	Q17
3	1	1	1	4	2	4	3	4	4	3	2	4	2	4	1	3

Q18	Q19	Q20	Q21	Q22	Q23	Q24	Q25	Q26	Q27	Q28	Q29	Q30
1	4	2	2	1	3	3	3	4	4	2	3	3

## Section B

Q31. F: Birds G: Insects

Q32. a) Part C

b) Part D

Q33. light; reflected

Q34. lost; gained

Q35. a) is heavier than

b) has the same mass as

Q36. a)

Variables	Independent Variable	Dependent Variable
Type of string	√	
Strength of the retort stand		
Type of weight added		
Number of weights added		√

b) The thickness of both strings should be kept the same.

c) String B

Q37. a) Part A: water Part B: food

b) They will be able to get the food carrying tubes in the stem and take in the food made by the plant.

- Q38. a) Electromagnets R and S  
b) The greater the number of batteries used, the greater the amount of paperclips get picked up.  
c) Increase the number of coils around the nail.

- Q39. a) The light from the lamp on the magician and he reflected the light into Tom's eyes.  
b) The reflected light cannot pass through the curtain into Tom's eyes.  
c) Light travels in straight lines.

- Q40. a) Container A: Wood Container B: Frosted glass.  
b) As container A is an opaque object, it does not allow any light to pass through it thus forming a dark shadow while container B is a translucent object and allows some light to pass through thus forming a faint shadow.

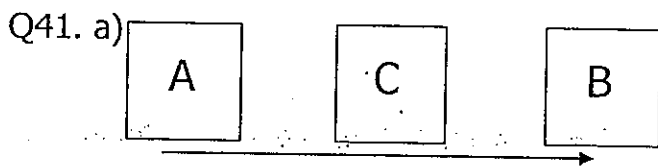

- b) Thermal flask A. It is the poorest conductor of heat and is able to keep water hot for the longest period of time.

- Q42. a) Animal A has 4 stages in its life cycle and it does not spend part of its life cycle in water.  
b) No. The young of a butterfly does not look like its adult and it has 4 stages in its life cycle while animal B does not have a 4 stage life cycle.  
c) Frog

- Q43. a) Liquid  
b) Substance Q does not have a definite volume at  $110^{\circ}\text{C}$  while substance R has a definite volume at  $110^{\circ}\text{C}$ .  
c) Substance Q. It has the same boiling and freezing point as pure water.

- Q44. a) Put hot water in a beaker instead of cold water.  
b) The warm water will evaporate into water vapour. When the water vapour touches the cooler underside of the aluminium foil, it will lose heat and condense into water droplet.

NANYANG PRIMARY SCHOOL

PRIMARY 4 SCIENCE

SEMESTRAL ASSESSMENT 1  
2013

**BOOKLET A**

Date : 14<sup>th</sup> May 2013

Duration : 1 h 45 min

Name : \_\_\_\_\_ (     )

Class: Primary 4 (     )

Parent's signature: .....

**DO NOT OPEN THIS BOOKLET UNTIL YOU ARE TOLD TO DO SO.  
FOLLOW ALL INSTRUCTIONS CAREFULLY.**

Booklet A consists of 17 printed pages including this cover page.