

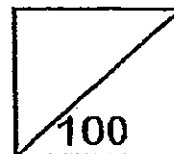

Rosyth School  
Semestral Examination for 2012  
STANDARD SCIENCE  
Primary 5



Name: \_\_\_\_\_

Total  
Marks:

Class: Pr 5- \_\_\_\_\_

Register No. \_\_\_\_\_

Duration: 1 h 45 min

Date: 14 May 2012

Parent's Signature: \_\_\_\_\_

---

## Booklet A

**Instructions to Pupils:**

1. Do not open the booklets until you are told to do so.
2. Follow all instructions carefully.
3. This paper consists of 2 booklets, Booklet A and Booklet B.
4. For questions 1 to 30 in Booklet A, shade the correct ovals on the Optical Answer Sheet (OAS) provided using a 2B pencil.
5. For questions 31 to 44, give your answers in the spaces given in the Booklet B.

|           | Maximum   | Marks Obtained |
|-----------|-----------|----------------|
| Booklet A | 60 marks  |                |
| Booklet B | 40 marks  |                |
| Total     | 100 marks |                |

\* This booklet consists of 18 pages.

**Part I (60 Marks)**

For each question from 1 to 30, four options are given. One of them is the correct answer. Make your choice (1, 2, 3 or 4). **Shade the correct oval (1, 2, 3 or 4) on the Optical Answer Sheet.**

1. David wanted to find out if food is needed for living things to survive. Which of the following variables should he keep the same for the experiment?

A: air  
B: water  
C: food  
D: number of organism

- (1) A and B only  
(2) C and D only  
(3) A, B and D only  
(4) A, B, C and D

2. What is the similarity between birds and mammals?

(1) They have wings  
(2) They have two legs  
(3) They have a backbone  
(4) They have hair on their bodies

3. The diagram below shows a rose plant.

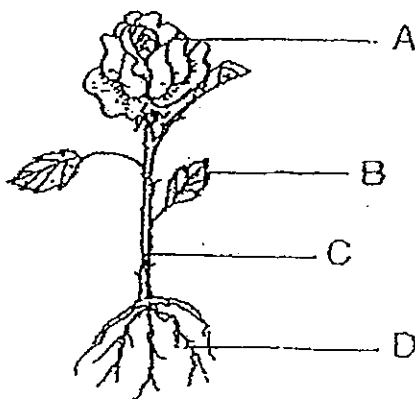

In which part of the rose plant (A, B, C or D) is food made?

- (1) A  
(2) B  
(3) C  
(4) D

4. Refer to the flowchart below.

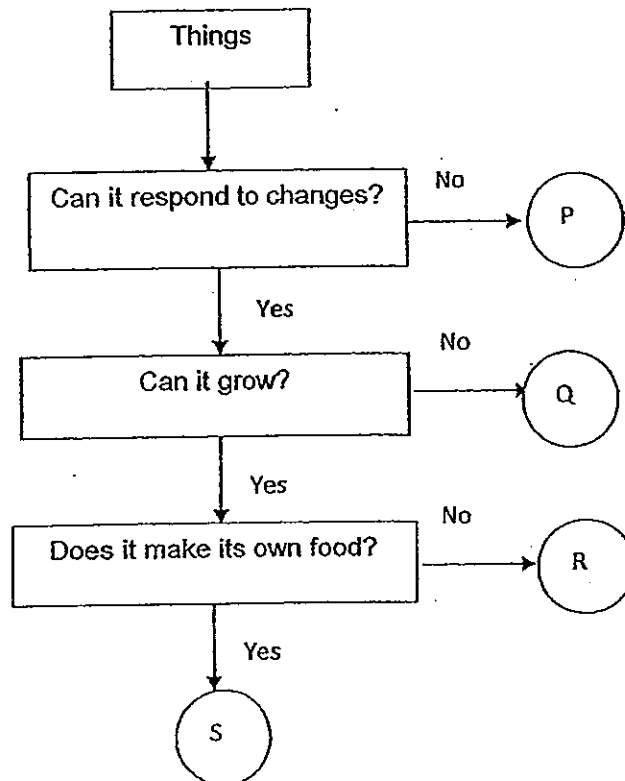

Which one of the above represents a plant?

- (1) P
- (3) R

- (2) Q
- (4) S

5. The diagram below shows a seedling.



At this stage of growth, from which part does the seedling get its food?

- (1) roots  
(2) stem  
(3) leaves  
(4) seed leaves
6. Which of the following statements about cells are true?
- A: All cells are the building blocks of life.  
B: All cells cannot be seen by the naked eye.  
C: Living things can be made up of one cell or many cells.  
D: All cells are made up of a cell membrane, cytoplasm, nucleus and cell wall.
- (1) A and B only  
(2) A and C only  
(3) B and C only  
(4) C and D only
7. Look at the plant cell below carefully.

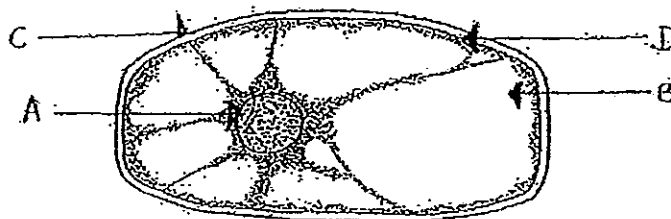

Which part of the cell supports and protects the cell?

- (1) A  
(2) B  
(3) C  
(4) D

8. Aminah referred to a table as shown below.

| Cell Types     | Cell Wall | Chloroplasts | Small Vacuoles | Nucleus |
|----------------|-----------|--------------|----------------|---------|
| Hydrilla Cell  | Yes       | Yes          | No             | Yes     |
| Cheek cell     | No        | No           | Yes            | Yes     |
| Red Blood cell | No        | No           | Yes            | No      |

Based on the above information, she drew a flow chart as shown below.

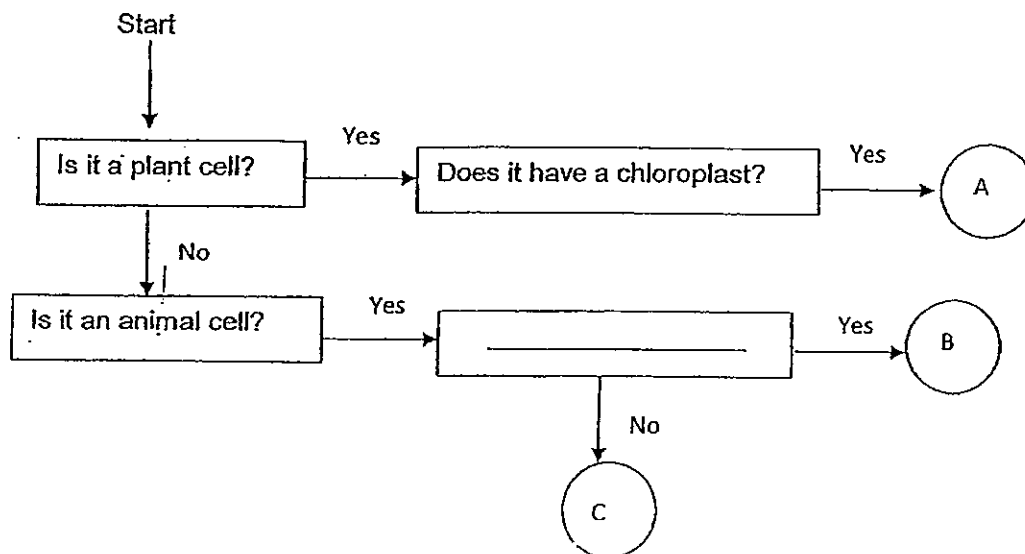

What question should be asked so that C can represent red blood cells?

- (1) Does it have a nucleus?
- (2) Does it have a cell wall?
- (3) Does it have chloroplast?
- (4) Does it have small vacuoles?

9. Study the activity below.

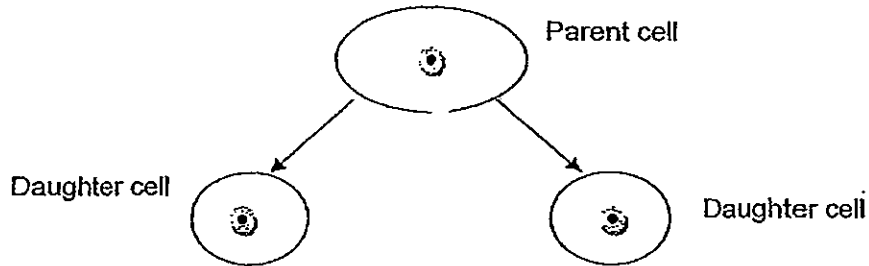

Which part of the cell controls the above activity?

- (1) Nucleus
- (2) Cytoplasm
- (3) Cell membrane
- (4) Cell wall

10. The table below lists the parts of a cell. The tick (✓) represents the part of a cell W, X, Y and Z have.

| Part of the cell | Cell W | Cell X | Cell Y | Cell Z |
|------------------|--------|--------|--------|--------|
| Cytoplasm        | ✓      | ✓      | ✓      | ✓      |
| Cell membrane    | ✓      | ✓      | ✓      | ✓      |
| Cell wall        |        | ✓      | ✓      |        |
| Nucleus          |        | ✓      | ✓      | ✓      |
| Chloroplast      |        |        | ✓      |        |

Siti studied the onion shoot growing from an onion as shown below.

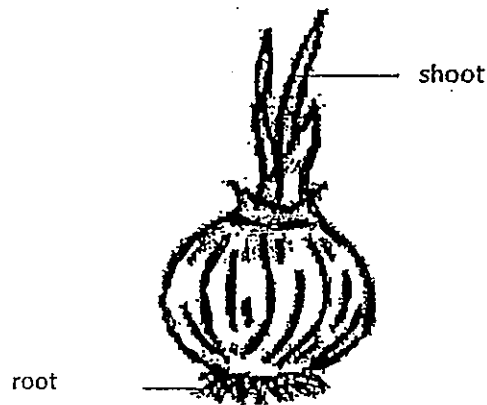

Which cell will most likely represent the shoot of the onion?

- (1) Cell W
- (2) Cell X
- (3) Cell Y
- (4) Cell Z

11. Kok Meng saw fruits growing on a plant as shown below.

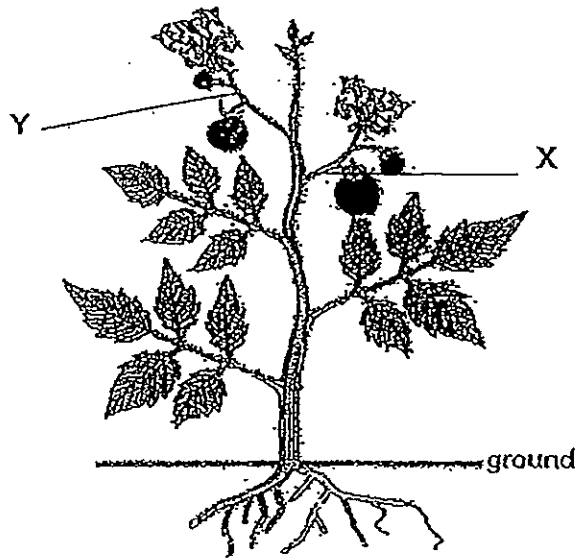

He removed part(s) of the covering on branch X. After a week he observed that the fruits on branch Y were bigger while the fruits on branch X remained the same size.

Kok Meng made a reference to a cross-section of a plant stem as shown below.

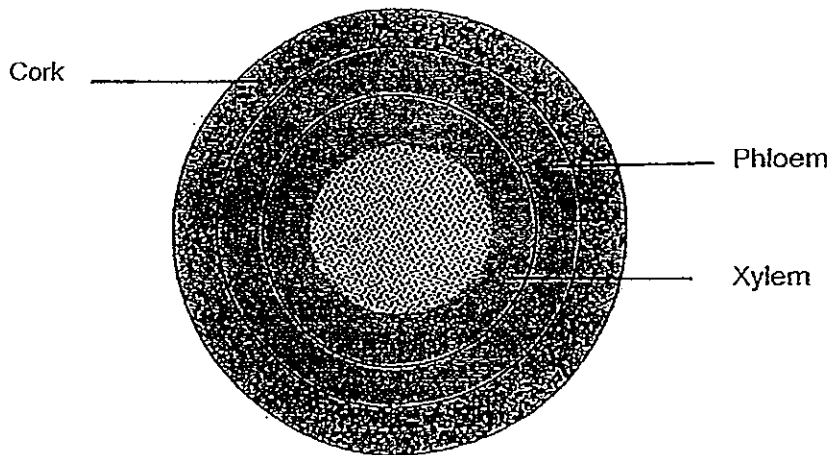

Which part(s) of the stem did he remove?

- (1) cork only
- (2) cork and phloem only
- (3) phloem and xylem only
- (4) cork, phloem and xylem

12. Sam studied the traffic on Singapore roads. He drew four different ways in which the cars can travel on the roads.

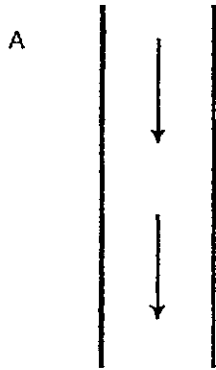

One- way traffic on a road

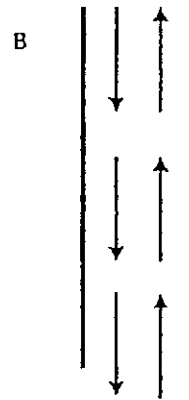

Two- way traffic on a road

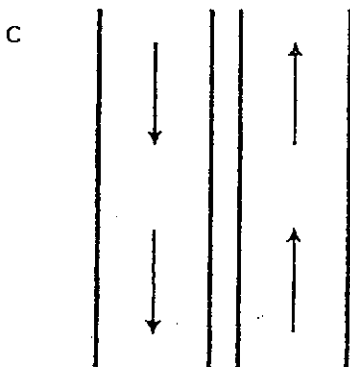

Two- way traffic on two separate roads

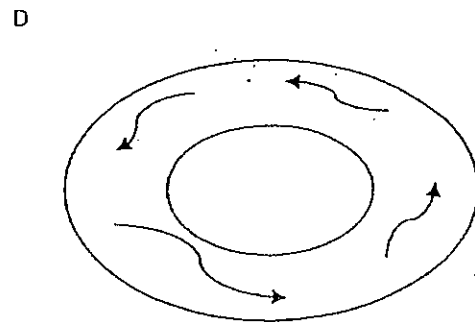

A roundabout traffic.

Which of the above best represents the plant transport system for both food and water?

- (1) A
- (3) C

- (2) B
- (4) D



13. Ahmad set up four boxes with plants covered with four types of paper A, B, C and D with different degrees of transparency respectively.

He recorded the transparency of the papers as shown below.

| Paper | Amount of light that can pass through it (lux) |
|-------|--|
| A     | 400  |
| B     | 800  |
| C     | 1000   |
| D     | 600  |

In which box (A, B, C or D) will the water uptake be the most?

- (1) A  
 (2) B  
 (3) C  
 (4) D

14. Study the table below about the human circulatory system and the plant transport system.

|     | Human Circulatory System  | Plant Transport System   |
|-----|---|--|
| (A) | Does not have tubes to transport materials                                  | Has tubes that transport materials   |
| (B) | Transports oxygen, digested food, carbon dioxide, water and other materials | Transports water, dissolved mineral salts and food to other parts of the plant |
| (C) | Transports undigested food  | Transports food produced by the leaves   |
| (D) | Has a heart to pump blood through the system                                | Has no part to pump the substances through the system                          |

Which of the following statements above are true about the human circulatory and plant transport systems?

- (1) A and B only  
 (2) B and D only  
 (3) A, C and D only  
 (4) B, C and D only

15. Devi prepared a set-up as shown below.

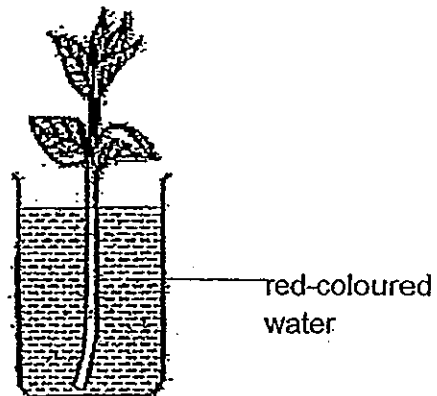

She observed that the leaves were stained red after a few days.

Next she prepared another set-up as shown below.

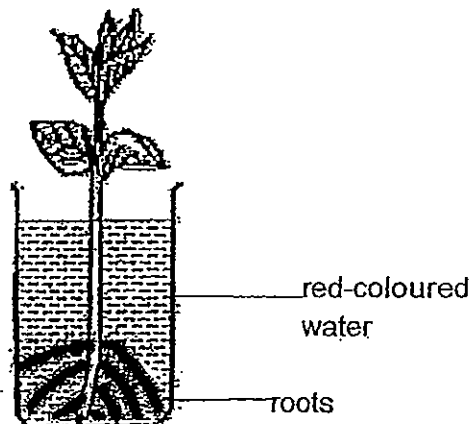

She wanted to observe if the leaves were stained red after a few days.

What is the aim of her experiment?

- (1) To find out if roots are needed for the uptake of water
- (2) To find out if roots will affect the uptake of coloured water
- (3) To find out if stem will affect the uptake of coloured water
- (4) To find out if stem is needed for the transport of coloured water

16. Which of the following parts belong to the circulatory system?

- A: nose
- B: mouth
- C: heart
- D: blood vessels

(1) A and B only

(2) C and D only

(3) B, C and D only

(4) A, B, C and D

17. Study the two diagrams below. They show the respiratory systems of two organisms.

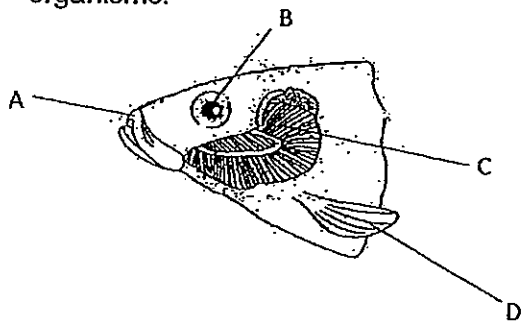

Organism X

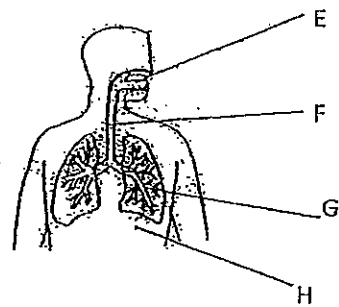

Organism Y

Which part of the respiratory system of organisms X and Y allow the exchange of gases to take place?

|     | Organism X | Organism Y |
|-----|------------|------------|
| (1) | B          | F          |
| (2) | A          | E          |
| (3) | C          | G          |
| (4) | D          | H          |

18. Which of the following statements about our body systems are true when we are sleeping?

- A: The digestive system breaks down food.
- B: The skeletal and muscular systems allow movement.
- C: The circulatory system transports nutrients around our body.
- D: The respiratory system exchanges carbon dioxide for oxygen.

(1) A and B only

(2) B and C only

(3) B, C and D only

(4) A, B, C and D

19. Arrange the following statements in the correct order to show how the circulatory system works in our body.

- A: The heart pumps the blood back to the lungs.
- B: Blood that is now rich in oxygen flows to the heart.
- C: The heart then pumps the blood to the rest of the body.
- D: Blood that is rich in carbon dioxide flows back to the heart.

(1) A, D, C, B

(2) B, D, C, A

(3) D, C, A, B

(4) D, A, B, C

20. The breathing rate of a girl was measured when she carried out three activities one after another for a certain period of time. First she rested on a bed, then she jogged on the spot and finally sat down to rest.

Which one of the graphs represents the breathing rate of the girl?

(1)

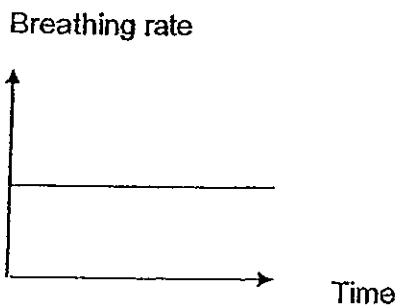

(2)

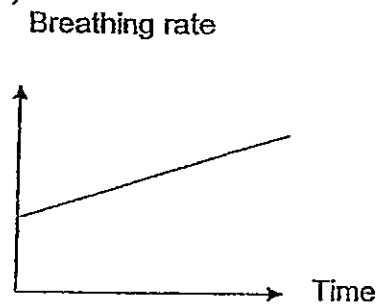

(3)

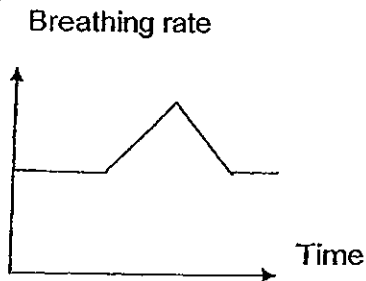

(4)

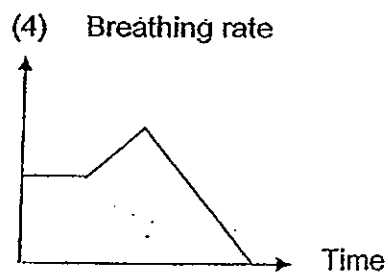

21. A nail was used to scratch the surface of four materials W, X, Y and Z. The depth of the scratches on the surfaces were recorded.

| Material | Depth of scratches(mm) |
|----------|------------------------|
| W        | 10                     |
| X        | 1                      |
| Y        | 6                      |
| Z        | 15                     |

Which is the best material to make a chopper to cut mutton into pieces?

- (1) W  
(3) Y

- (2) X  
(4) Z

22. Which of the following materials is an insulator of electricity?

- (1) iron
- (3) copper

- (2) steel
- (4) plastic

23. Study the table below.

| Material | Properties                             |
|----------|--|
| P        | Waterproof<br>Transparent              |
| Q        | Hard<br>Fragile                        |
| R        | Waterproof<br>Conductor of electricity |
| S        | Hard<br>Opaque                         |

Based on the above information, which of the following material(s) is/are definitely conductor(s) of heat?

- (1) P only
- (3) Q and R only

- (2) R only
- (4) P and S only

24. Ah Lim wanted to find out the strength of four different strips of materials. He hung 4 different amounts of weights( 150g, 300g, 450g and 650g ) onto the strips and observed if they would break. The results of his experiment are shown in the table below.

| Type of materials | Weight hung   |               |               |       |
|-------------------|---------------|---------------|---------------|-------|
|                   | 150g          | 300g          | 450g          | 650g  |
| Material 1        | broke         | broke         | broke         | broke |
| Material 2        | did not break | broke         | broke         | broke |
| Material 3        | did not break | did not break | did not break | broke |
| Material 4        | did not break | did not break | broke         | broke |

Which material should Ah Lim choose if he wants to hang a bundle of 400g of newspapers?

- (1) Material 1  
(2) Material 2  
(3) Material 3  
(4) Material 4
25. Minah tested a simple electrical circuit using materials W, X, Y and Z with different combinations. She recorded the results as shown below.

| Materials | Does the bulb light up? |
|-----------|-------------------------|
| X and Y   | No                      |
| W and X   | Yes                     |
| Y and Z   | No                      |
| W and Z   | Yes                     |

Which of the following materials are conductors of electricity?

- (1) W and X only  
(2) W and Z only  
(3) X, Y and Z only  
(4) W, X and Z only



26. The circuit below has four bulbs.

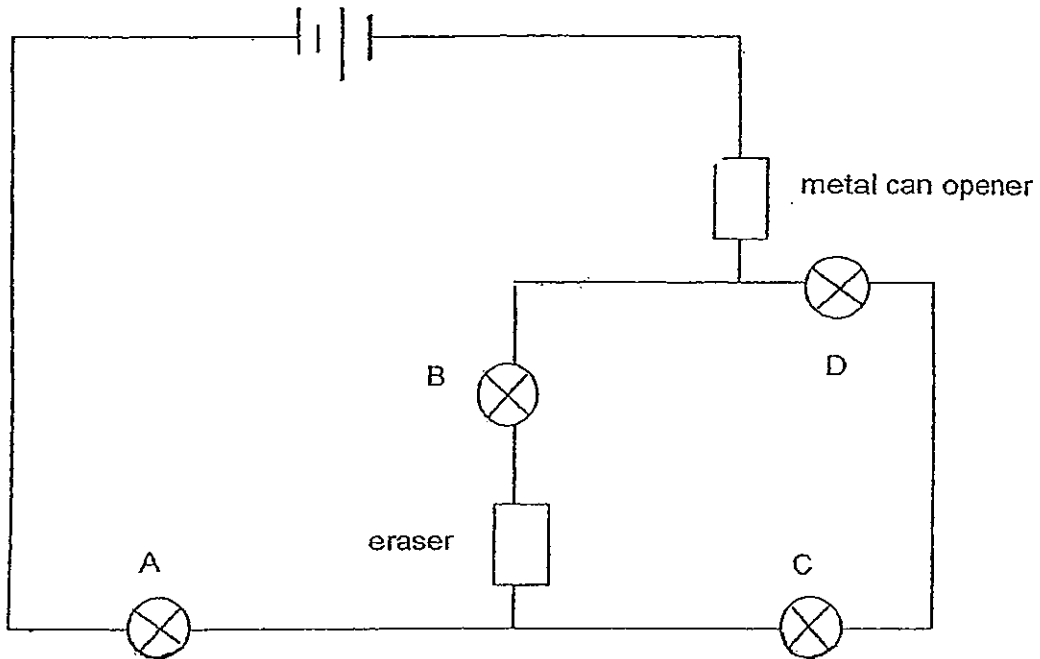

Which one of the above bulbs will not light up?

- |       |       |
|-------|-------|
| (1) A | (2) B |
| (3) C | (4) D |

27. Li Peng wanted to find out how the arrangement of bulbs in a circuit affects the brightness of the bulbs. Which variables should she keep the same for a fair experiment?

- A: The number of bulbs
- B: Brightness of the bulbs
- C: The number of batteries
- D: The voltage of the bulbs

- |                     |                   |
|---------------------|-------------------|
| (1) A and B only    | (2) C and D only  |
| (3) A, C and D only | (4) A, B, C and D |

28. All the batteries, wires and bulbs used in each of the four electrical circuits below are identical. Arrange the circuits from the brightest to the least bright.

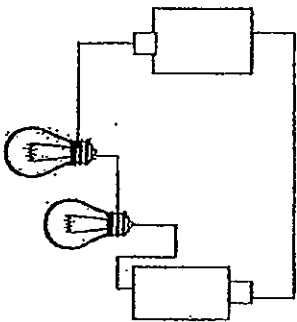

Circuit A

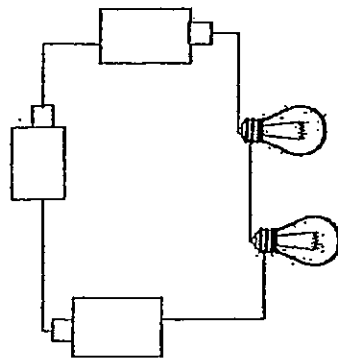

Circuit B

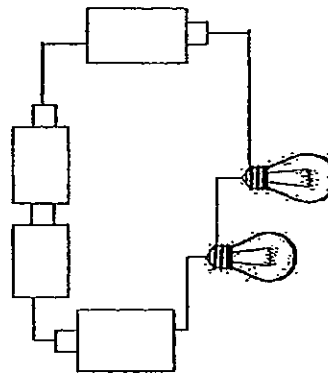

Circuit C

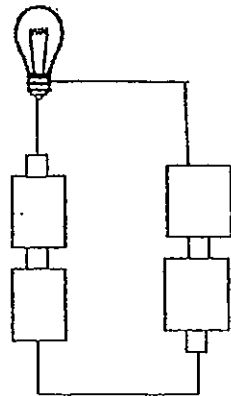

Circuit D

- (1) D, C, A, B  
 (3) D, B, C, A

- (2) D, A, B, C  
 (4) D, C, B, A

29. The circuit diagram below consists of 4 bulbs and 3 bells.

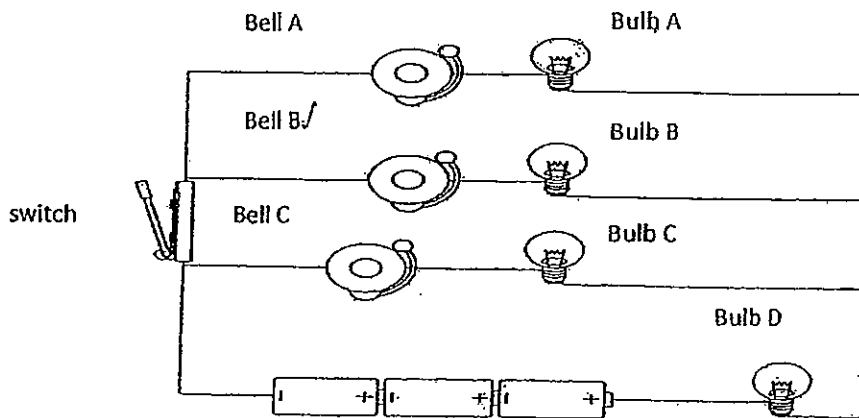

If the switch was closed, only bells B and C rang. Which bulbs in the circuit would light up when that happened?

- (1) A and B only  
 (2) B and C only  
 (3) B, C and D only  
 (4) A, B, C and D

30. A circuit was set up using three identical lamps L1, L2 and L3 and three switches S1, S2 and S3.

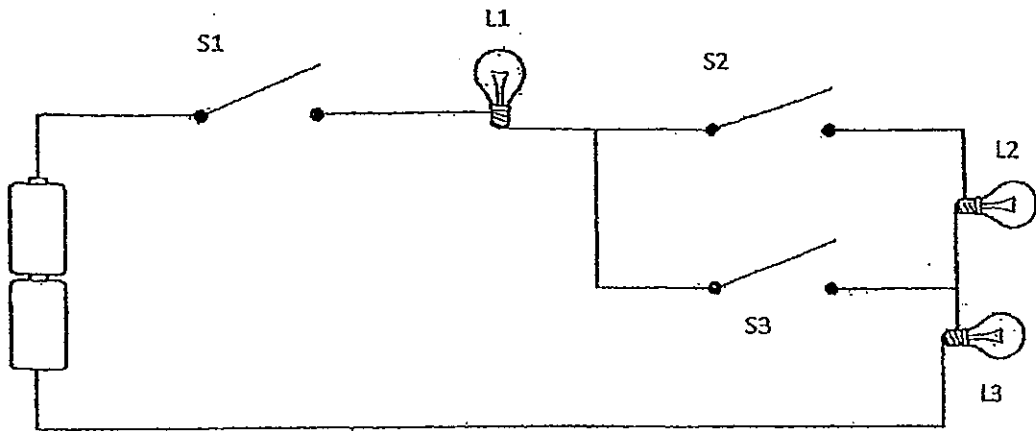

Under which conditions would only L2 not be lit?

| Condition | S1     | S2     | S3     |
|-----------|--------|--------|--------|
| A         | closed | open   | closed |
| B         | open   | closed | open   |
| C         | closed | closed | open   |
| D         | open   | closed | closed |

- (1) A only  
(3) A and D only

- (2) C only  
(4) A, B and D only

End of Part I



**Rosyth School**  
**Semestral Examination for 2012**  
**STANDARD SCIENCE**  
**Primary 5**

Total  
Marks:

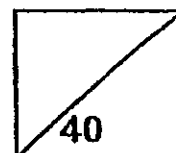

Name: \_\_\_\_\_

Class: Pr 5- \_\_\_\_\_

Register No. \_\_\_\_\_

Duration: 1 h 45 min

Date: 14 May 2012

Parent's Signature: \_\_\_\_\_

---

## **Booklet B**

**Instructions to Pupils:**

1. For questions 31 to 44, give your answers in the spaces given in this Booklet B.

\* This booklet consists of 14 pages.

**Part II (40 Marks)**

For questions 31 to 44, write your answers in this booklet.

31. Study the table carefully. Serene has divided the animals into two groups X and Y.

| Animals |             |
|---------|-------------|
| X       | Y           |
| Parrot  | Cockroach   |
| Eagle   | Butterfly   |
| Mynah   | Mosquito    |
| Chicken | Grasshopper |

- (a) Provide the headings for X and Y. (2m)

(i) X : \_\_\_\_\_

(ii) Y : \_\_\_\_\_

- (b) Now Serene wanted to divide the animals in group Y into 2 groups. Complete the table below. (2m)

| Y                      |                        |
|------------------------|------------------------|
| A : 3-stage life cycle | B : 4-stage life cycle |
|                        |                        |
|                        |                        |
|                        |                        |
|                        |                        |

32. The diagram below shows the roots of three different plants.

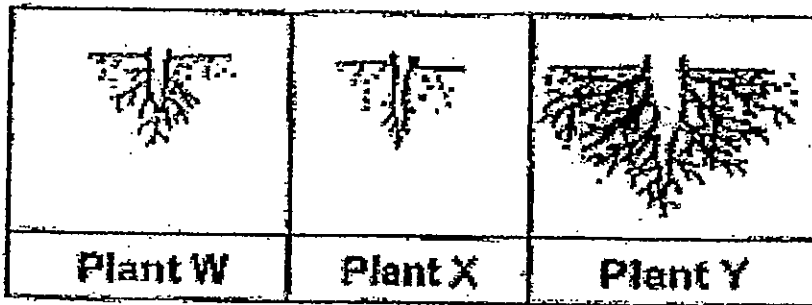

(a) Which plant has roots that hold it most firmly to the ground? Give a reason. (1m)

---

(b) Give another function of roots. (1m)

---

33. The diagram shows a single-cell organism when viewed under a microscope.

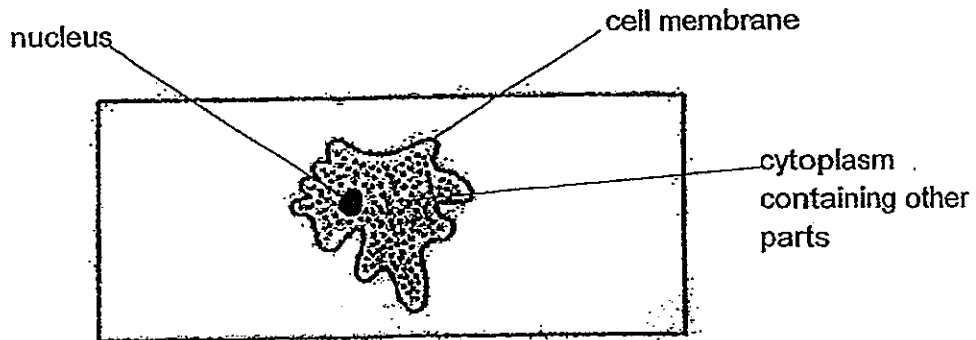

- (a) Does the cell belong to an animal or plant? Support your choice. (1m)

---

- (b) If you want to see the other parts in the cytoplasm, what will you have to do? (1m)

---

34. Ravi wanted to find out if the temperature of sugar solution affects the rate of cell division. He prepared the set-ups as shown in the table below.

| Set- up | Temperature of sugar solution |
|---------|-------------------------------|
| A       | 10°C                          |
| B       | 30°C                          |
| C       | 60°C                          |

He placed 20 yeast cells in each of the three similar containers. These containers were placed at the same location.

He recorded the results as shown below.

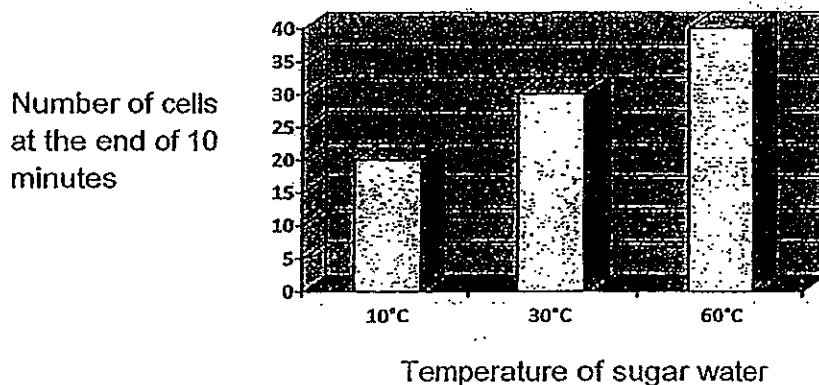

- (a) State two other variables that he should keep the same. (2m)

Ravi's mother wanted to use yeast cells to make bread as carbon dioxide produced by the yeast cells would make the bread soft.

- (b) Which temperature of water should his mother use to mix the yeast cells? Explain why. (1m)



35. Refer to the table below.

(a) Match the organisms to the correct type of organism. (1m)

| Organism | Type of Organism |
|----------|------------------|
| Amoeba   | Multicellular    |
| Frog     | Unicellular      |

(b) Why is cell division important for the two organisms above? (2m)

Amoeba: \_\_\_\_\_

\_\_\_\_\_

\_\_\_\_\_

Frog: \_\_\_\_\_

\_\_\_\_\_

\_\_\_\_\_

36. Stanley carried out an experiment as shown below. He set up beaker A and Beaker B. He put a balsam plant in Beaker A only. Both beakers have a layer of oil on the surface of the water. He then left both set-ups in the open for a week.

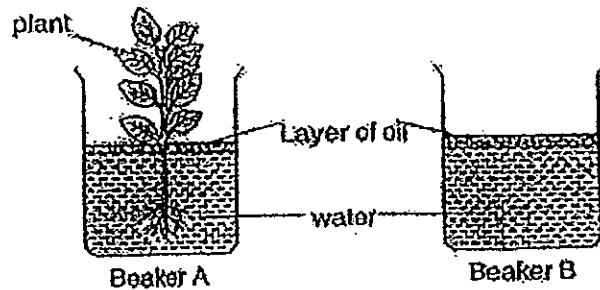

He recorded the water level in both beakers at the start of the experiment and at the end of the week. The results are shown in the table below.

| Beaker | Volume of water at the start of the experiment | Volume of water at the end of the experiment |
|--------|--|--|
| A      | 100 ml   | 85 ml  |
| B      | 100 ml   | 100 ml                                       |

- (a) Why was there less water left in Beaker A at the end of the experiment? (1m)

---



---

- (b) What is the purpose of setting up Beaker B in the experiment? (1m)

---



---

- (c) What should Stanley do to ensure that the result above is reliable? (1m)

---



---

37. Study the diagram below.

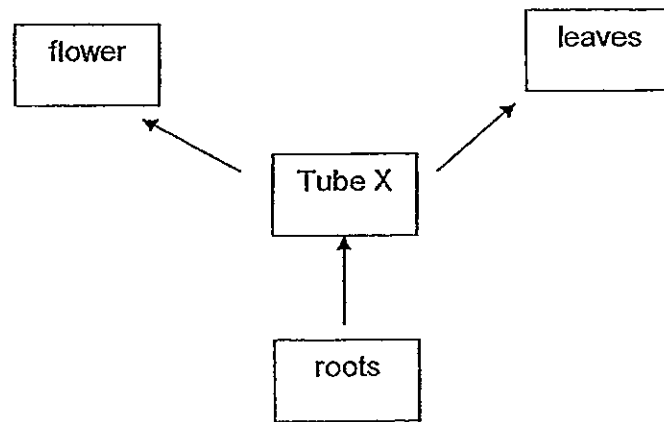

(a) Identify the tube X. (1m)

Mary prepared 3 set-ups A, B and C as shown below.

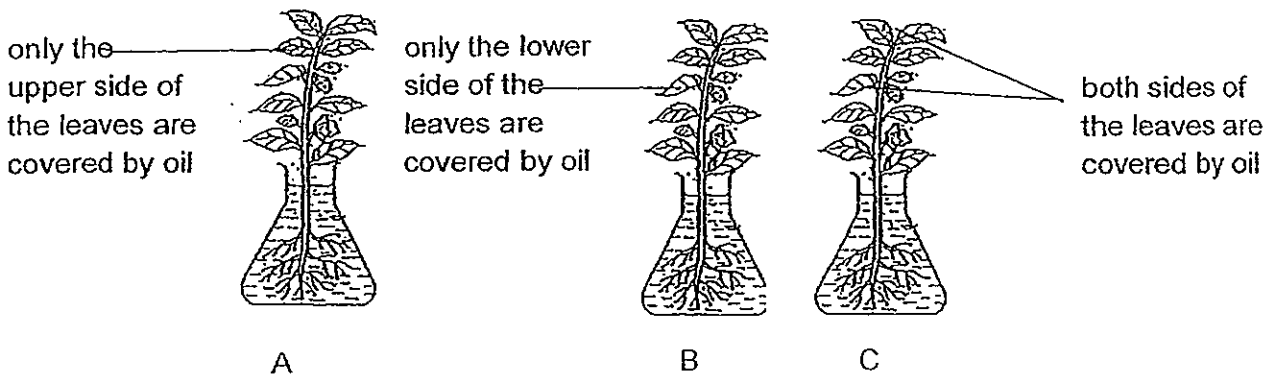

(b) Arrange the set-ups from the highest amount of water left to the lowest amount of water left in the flask after some time. (1m)

\_\_\_\_\_

(c) What factor has affected the rate of water absorption in the plants above? (1m)

\_\_\_\_\_

38. The diagrams below show our respiratory system and digestive system.

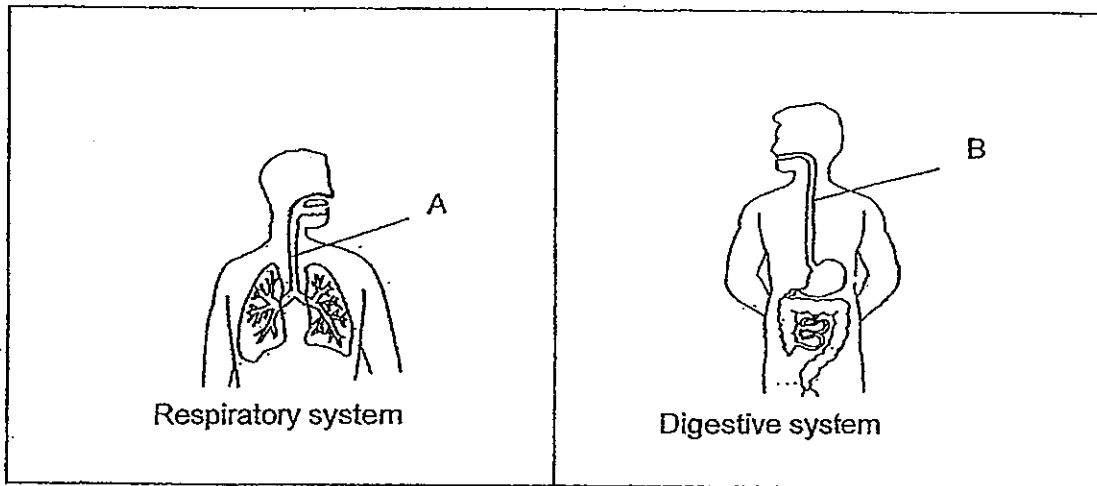

State the functions of Part A and Part B.

(2m)

Part A: \_\_\_\_\_  
\_\_\_\_\_

Part B: \_\_\_\_\_  
\_\_\_\_\_

39. The table below shows Jane's pulse rate as she cycles at different speed.

| Speed of cycling<br>(metres per minute) | Heart rate<br>(beats per minute) |
|---|----------------------------------|
| 10                                      | 80                               |
| 30                                      | 90                               |
| 50                                      | 100                              |
| 70                                      | 100                              |
| 90                                      | 100                              |

(a) Describe the relationship between speed of cycling and heart rate. (2m)

---

---

(b) Explain why the heart rate increases when we exercise. (2m)

---

---

40. The diagram below shows three parts of a human body.

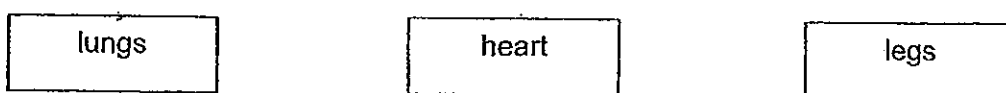

(a) Draw two arrows above to show how the blood rich in oxygen is circulated to the legs. (1m)

(b) How is the heart important to the system above? (1m)

---

---

(c) How do the respiratory system and the digestive system work together with the circulatory system? (2m)

(i) Respiratory system: \_\_\_\_\_

---

(ii) Digestive system: \_\_\_\_\_

---

41. Study the two circuits below. Identical bulbs and batteries have been used in the circuits.

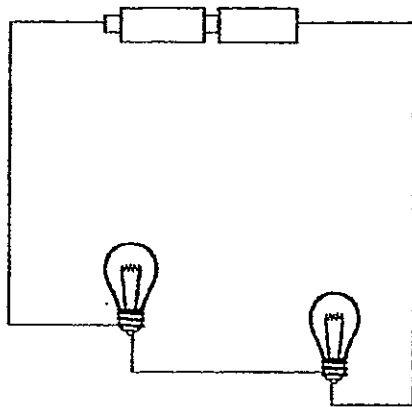

Circuit J

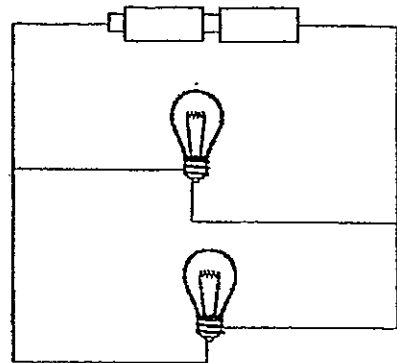

Circuit K

- (a) In what way is Circuit J different from Circuit K in terms of the arrangement of the bulbs? (1m)

---

---

- (b) What should you do if you want the brightness of the bulbs in Circuit J to be the same as Circuit K without changing the arrangement of bulbs? (1m)

---

---

- (c) Which circuit J or K would you prefer to use in your home? Explain why. (1m)

---

---

42. Peter used two bulbs, two batteries and some wires to set up Circuit A as shown below. The bulbs and batteries are identical.

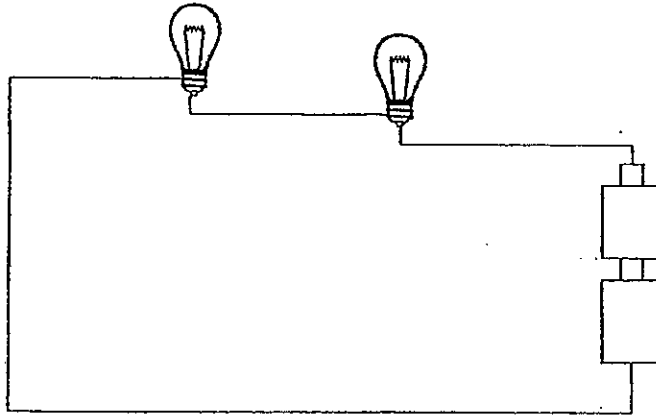

Circuit A

He repeated the experiment with a different number of batteries. The results of the experiment are shown in the table below. On a rating scale of (1) – (3), (1) represents the least bright and (3) represents the brightest.

| Number of batteries | Rating scale |
|---------------------|--------------|
| 3                   | (1)          |
| 4                   | (2)          |
| 5                   | (3)          |

- (a) What was the aim of Peter's experiment? (1m)

---



---

- (b) When a sixth battery was added to the circuit, the bulbs did not light up even though the batteries were arranged in the correct way. Explain why. (1m)

---



---



43. In Singapore, you can find solar light trees in certain places.

(a) What is the main electric source for the solar light tree to be lit? (1m)

\_\_\_\_\_

(b) What is the advantage of using solar light trees as compared to the normal street lamps? (1m)

\_\_\_\_\_

\_\_\_\_\_

44. Three rods P, Q and R were placed in the two electric circuits shown below. The bulbs in both circuits lit up.

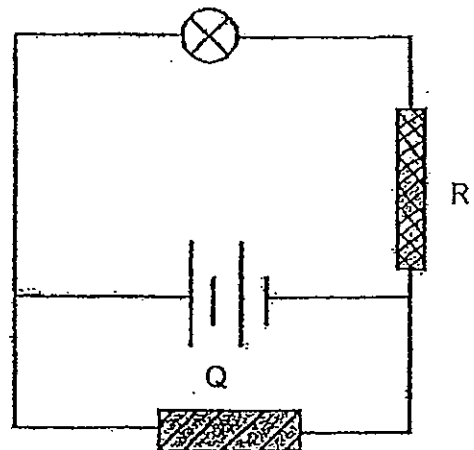
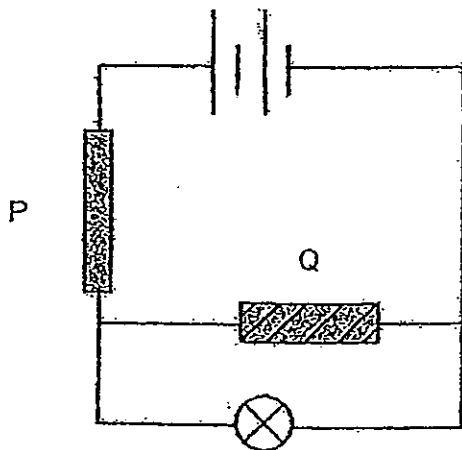

(a) One of the rods was an electrical insulator. State which rod it was. (1m)

\_\_\_\_\_

\_\_\_\_\_

Question 44 is continued on page 14

The three rods, P, Q and R were then placed at positions A, B and C in another electric circuit as shown below.

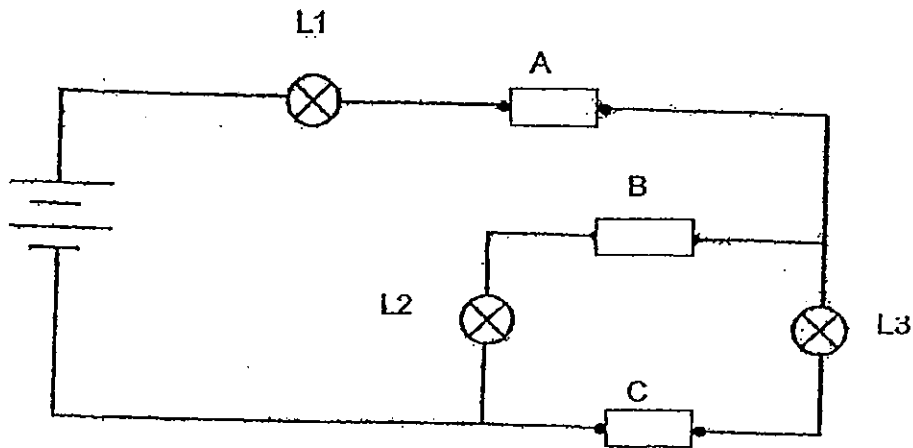

- (b) Complete the table below. For each scenario, indicate which bulbs lit up by putting a tick (✓) in the correct column. (2m)

| Scenario | Positions where rods were placed |            |            | Lamps that lit up |    |    |
|----------|----------------------------------|------------|------------|-------------------|----|----|
|          | Position A                       | Position B | Position C | L1                | L2 | L3 |
| 1        | P                                | R          | Q          |                   |    |    |
| 2        | R                                | Q          | P          |                   |    |    |

End of Paper

# ANSWER SHEET

EXAM PAPER 2012

SCHOOL : ROSYTH  
SUBJECT : PRIMARY 5 SCIENCE

TERM : SA1

|    |    |    |    |    |    |    |    |    |     |     |     |     |     |     |     |     |
|----|----|----|----|----|----|----|----|----|-----|-----|-----|-----|-----|-----|-----|-----|
| Q1 | Q2 | Q3 | Q4 | Q5 | Q6 | Q7 | Q8 | Q9 | Q10 | Q11 | Q12 | Q13 | Q14 | Q15 | Q16 | Q17 |
| 3  | 3  | 2  | 4  | 4  | 2  | 3  | 1  | 1  | 3   | 2   | 3   | 3   | 2   | 2   | 2   | 3   |

|     |     |     |     |     |     |     |     |     |     |     |     |     |
|-----|-----|-----|-----|-----|-----|-----|-----|-----|-----|-----|-----|-----|
| Q18 | Q19 | Q20 | Q21 | Q22 | Q23 | Q24 | Q25 | Q26 | Q27 | Q28 | Q29 | Q30 |
| 4   | 4   | 3   | 2   | 4   | 2   | 3   | 4   | 2   | 3   | 4   | 3   | 1   |

31)a) i) Birds                      ii) Insects

b) A: Parrot, Eagle, Mynah, Chicken, Grasshopper, Cockroach

B: Mosquito, Butterfly

32)a) Plant Y. It has the deepest roots that spread the most into the soil.

b) It absorbs water and nutrients from the ground.

33)a) Animal cell. Animal cells do not have cell wall to give them shape.

b) Magnify the cell to a bigger magnification.

34)a) Type of yeast cells and type of sugar.

b) 10°C. There will be most cells some carbon dioxide will be produced.

35)a) Amoeba                                      Multicellular

Frog

Unicellular

b) Amoeba: Cell division replaces the damaged cells and replaces the cells which are dead to continue its living in earth.

Frog: Cell division replaces the damaged cells and replaces the cells which are dead to continue its living in earth.

36)a)The roots of the plant absorbed the water for the plant so there was less water left in Beaker A.

b)It is to prove that plants take in water.

c)Repeat the test.

37)a)Xylem tube.

b)C, B, A.

c)Number of stomata.

38)Part A: It pushes the oxygen to the lungs.

Part B: It pushes the food to the stomach.

39)a)The higher be intensity of the acuity the faster the heart rate until it reaches 100 heart beats per minute after which the heart rate remains the same.

b)The heart rate increases to pump blood faster to give more oxygen to the body parts.

40)a)lungs → heart → legs

b)It pumps the blood rich in oxygen to the legs.

c)i)It provides oxygen to be transported in the body.

ii)It provides digested food to be transported in the body.

41)a)Circuit J is in series arrangement while Circuit K is in Parallel arrangement.

b)Add in two more batteries to Circuit J arrangement one batteries in Circuit K.

c)Circuit K. If one of the bulbs fuses the others will still light up.

42)a)To see if the number of batteries affect the brightness of the bulb.

b)The filament of the bulbs became too hot and fused and this created

43)a)Sun.

b)Sun is a renewable source of energy.

44)a)Rod Q.

b)1)L1, L2

2)L1, L3