



Rosyth School
Preliminary Examination 2012
Primary 6 Mathematics

Name: _____

Register No. _____

Class: Pr 6- _____

Date: 23 August 2012

Parent's Signature: _____

Total Time for Booklets A and B : 50 minutes

PAPER 1
(Booklet A)

Instructions to Pupils:

1. Do not open this booklet until you are told to do so.
2. Follow all instructions carefully.
3. Shade your answers in the Optical Answer Sheet (OAS) provided.
4. You are not allowed to use a calculator.
5. Answer all questions.

Section	Maximum Mark	Marks Obtained
Paper 1 (Booklet A)	20	

* This booklet consists of 7 pages (excluding this cover page)

This paper is not to be reproduced in part or whole without the permission of the Principal.

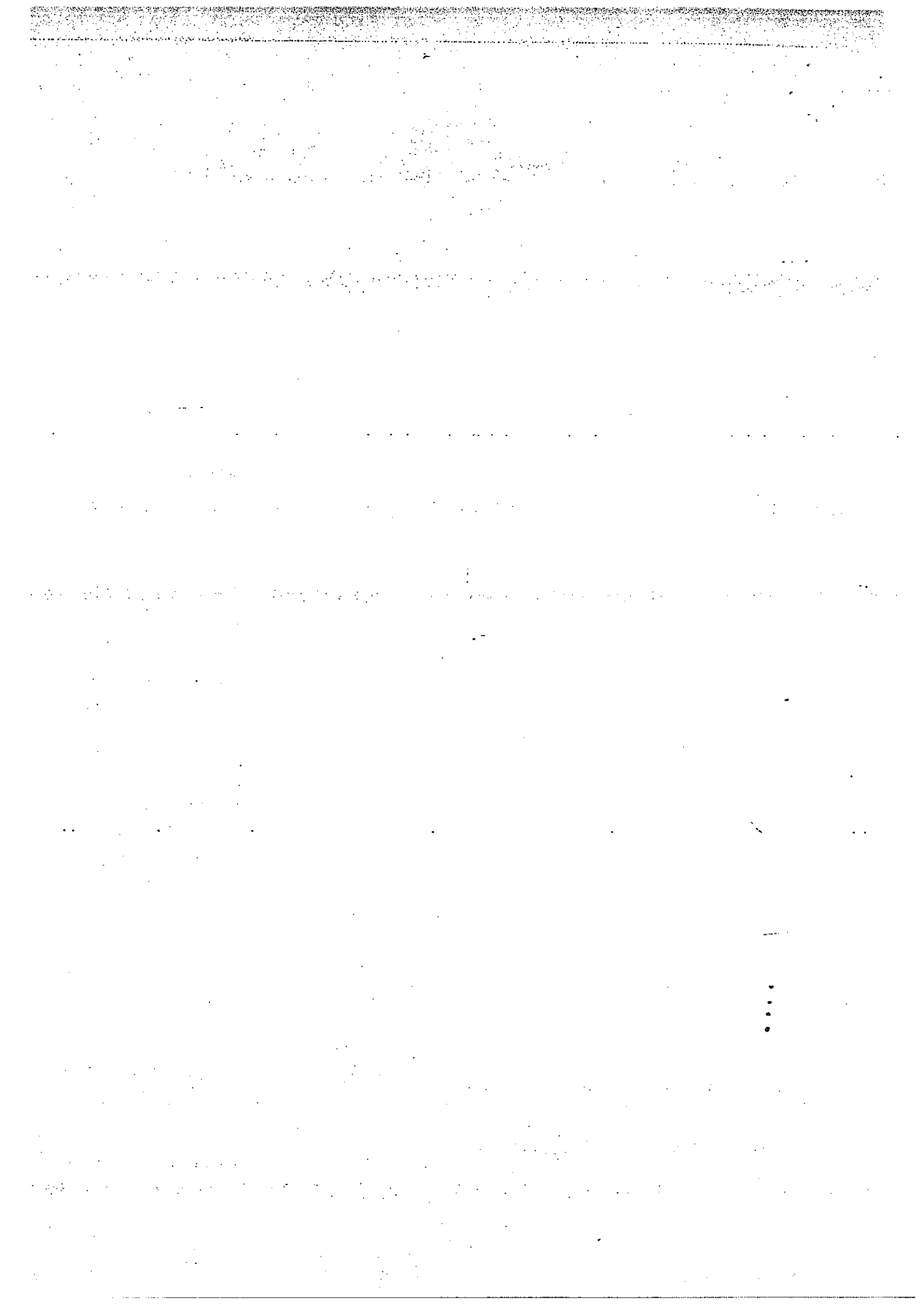

Questions 1 to 10 carry 1 mark each. Questions 11 to 15 carry 2 marks each. For each question, four options are given. One of them is the correct answer. Make your choice (1, 2, 3 or 4). Shade the oval (1, 2, 3 or 4) on the Optical Answer Sheet.

(20 marks)

1. Find the quotient when 6024 is divided by 6.

- (1) 14
- (2) 104
- (3) 1 004
- (4) 1 044

2. Chris starts counting 9 to 79, taking one second to say each number. How long does he take to count from 9 to 79 altogether?

- (1) 1 min 9 sec
- (2) 1 min 10 sec
- (3) 1 min 11 sec
- (4) 1 min 19 sec

3. $\frac{1}{8} + \frac{2}{8} + \frac{3}{8} = \boxed{?} \times 3$

- (1) $\frac{1}{4}$
- (2) $\frac{1}{8}$
- (3) $\frac{1}{12}$
- (4) $\frac{3}{4}$

4. 3 hundreds, 9 tenths and 5 thousandths is ?

(1) 300.095

(2) 300.905

(3) 300.950

(4) 390.005

5. The solid below is painted blue. How many cubes have 3 faces painted blue?

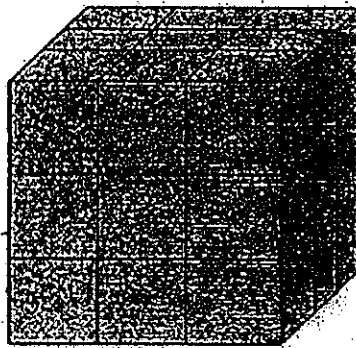

(1) 8

(2) 19

(3) 27

(4) 4

6. How many faces does the following solid have?

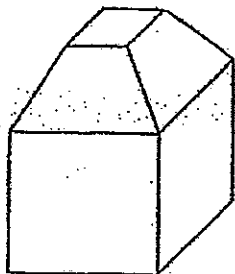

- (1) 5
- (2) 7
- (3) 9
- (4) 10

7. Juliana had \$800. She gave \$40y to her son and the remainder was shared equally among her 3 daughters. How much did each daughter receive?

- (1) $\$(\frac{760y}{3})$
- (2) $\$(\frac{800-40y}{3})$
- (3) $\$(800 - \frac{40y}{3})$
- (4) $\$(800 - 120y)$

8. Arun was born on 13 April 2003.
How old will he be on 13 November 2012?

- (1) 9 years 7 months
- (2) 9 years 8 months
- (3) 10 years 7 months
- (4) 10 years 8 months

9. The graph below shows the points scored by pupils who participated in a Math competition. 2 points were awarded for each correct answer and 1 point was awarded for a partially correct answer. What is the maximum number of questions answered correctly by Suling?

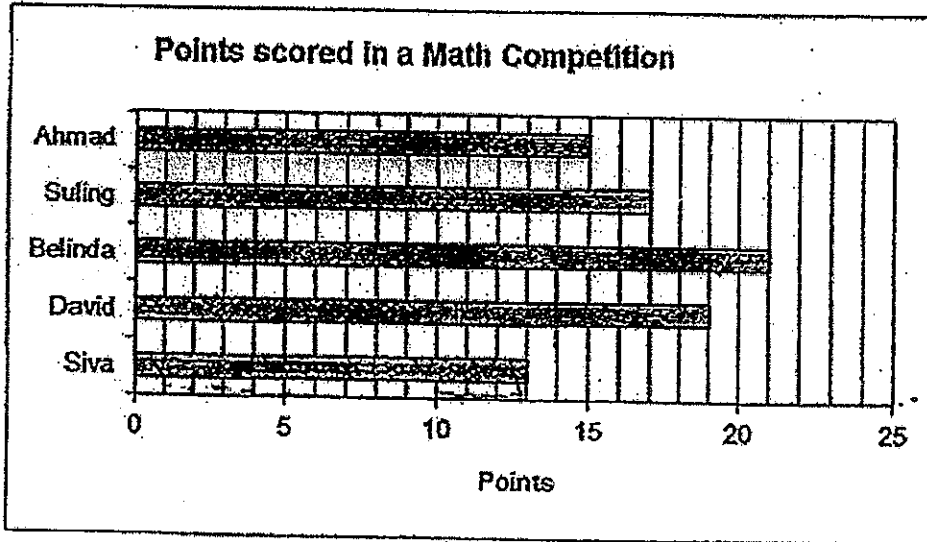

- (1) 8
- (2) 9
- (3) 16
- (4) 17

10. Sharon's luggage weighs 12.3 kg. Muthu's luggage is 940 g lighter than Sharon's. What is the mass of Muthu's luggage?

- (1) 11 kg 36 g
- (2) 11 kg 360 g
- (3) 13 kg 24 g
- (4) 13 kg 240 g

11. A supermarket had a promotion that allowed an exchange of chocolate wrappers for free chocolate bars.

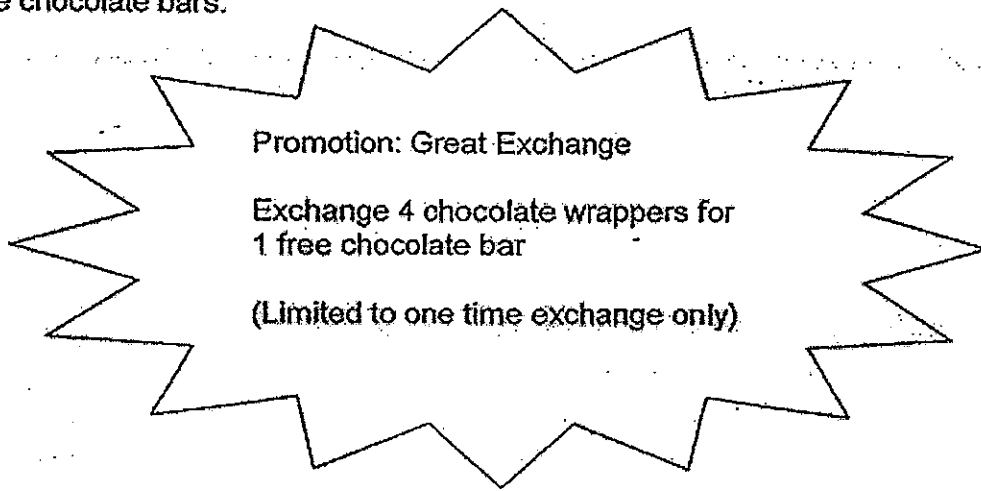

Menasha had 256 chocolate wrappers. What is the largest possible number of free chocolate bars that Manesha could have exchanged?

- (1) 51
- (2) 52
- (3) 64
- (4) 65

⋮

12. The figure below is not drawn to scale. Find the value of x .

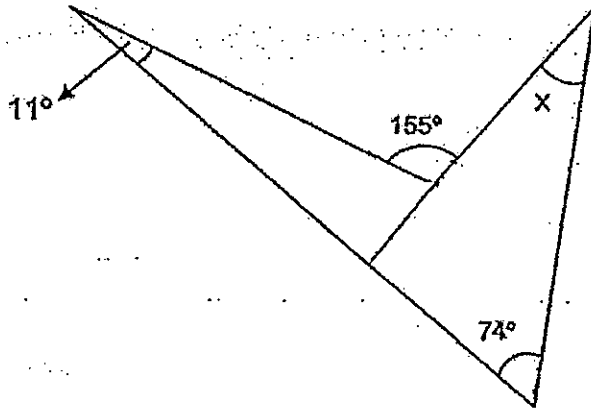

- (1) 11°
- (2) 14°
- (3) 70°
- (4) 95°

13. Given that 40 % of $P = 25$ % of Q , what percentage of P is Q ?

- (1) 15 %
- (2) 62.5 %
- (3) 65 %
- (4) 160 %

14. The figure below shows a rectangle ABCD. E is the mid-point of BD and F is the mid-point of BE. Given that the total shaded area is 147 cm^2 and the length of AD is 21 cm, find the length of DC.

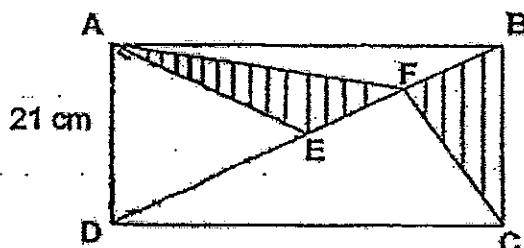

- (1) 14 cm
 (2) 21 cm
 (3) 28 cm
 (4) 42 cm
15. Miss Sum covered $\frac{2}{5}$ of the journey at an average speed of 60 km/h for $3\frac{1}{2}$ hours. She continued her remaining journey at the same speed. Find the distance of her remaining journey.

- (1) 105 km
 (2) 210 km
 (3) 315 km
 (4) 525 km

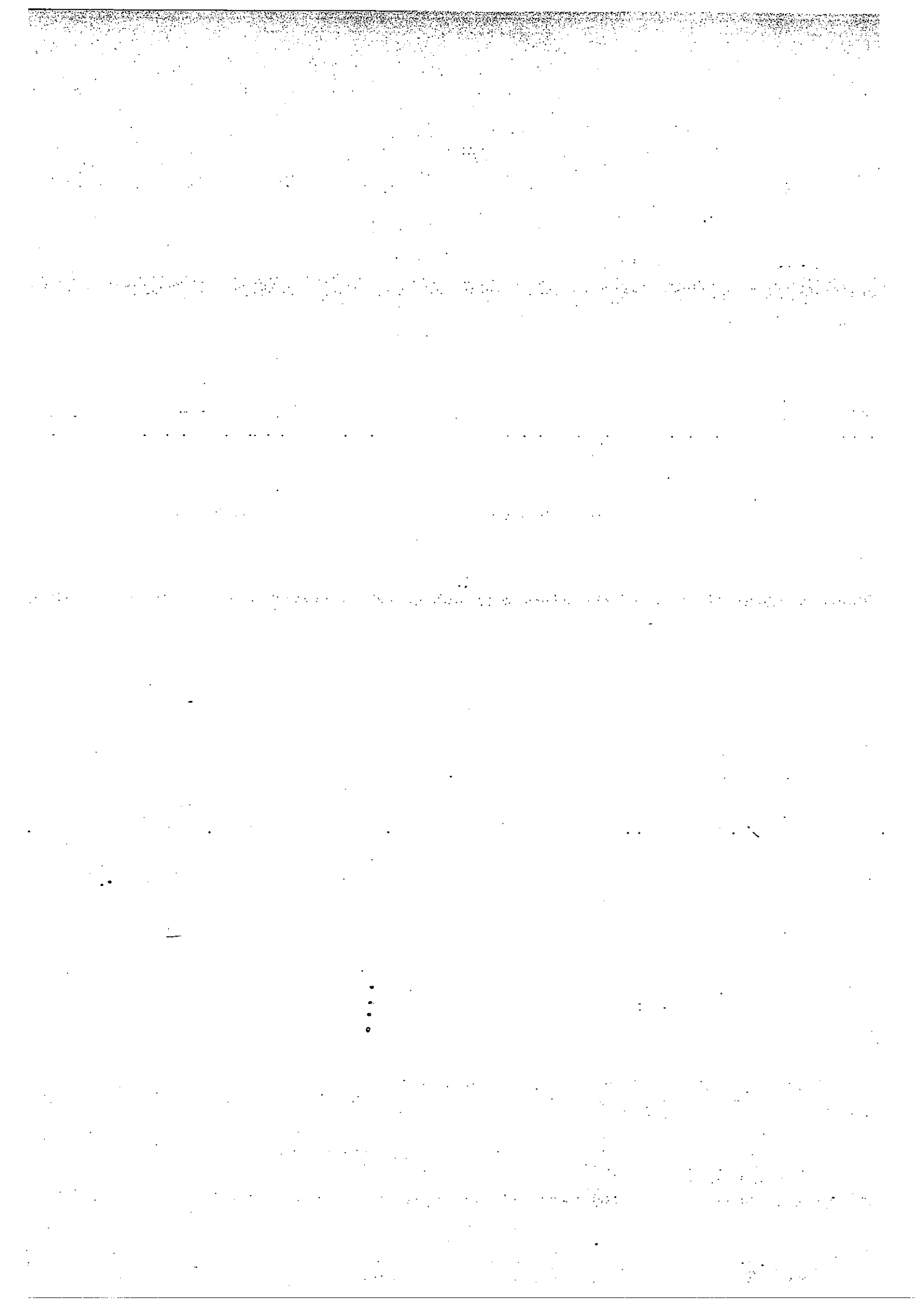

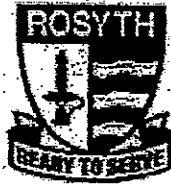

Rosyth School
Preliminary Examination 2012
Primary 6 Mathematics

Name: _____ Register No. _____

Class: Pr 6 - _____

Date: 23 August 2012 Parent's Signature: _____

Total Time for Booklets A and B : 50 minutes

PAPER 1
(Booklet B)

Instructions to Pupils:

1. Do not open this booklet until you are told to do so.
2. Follow all instructions carefully.
3. You are not allowed to use a calculator
4. Answer all questions.

Section	Maximum Mark	Marks Obtained
Paper 1 (Booklet B)	20	

*** This booklet consists of 7 pages (excluding this cover page)**

This paper is not to be reproduced in part or whole without the permission of the Principal.

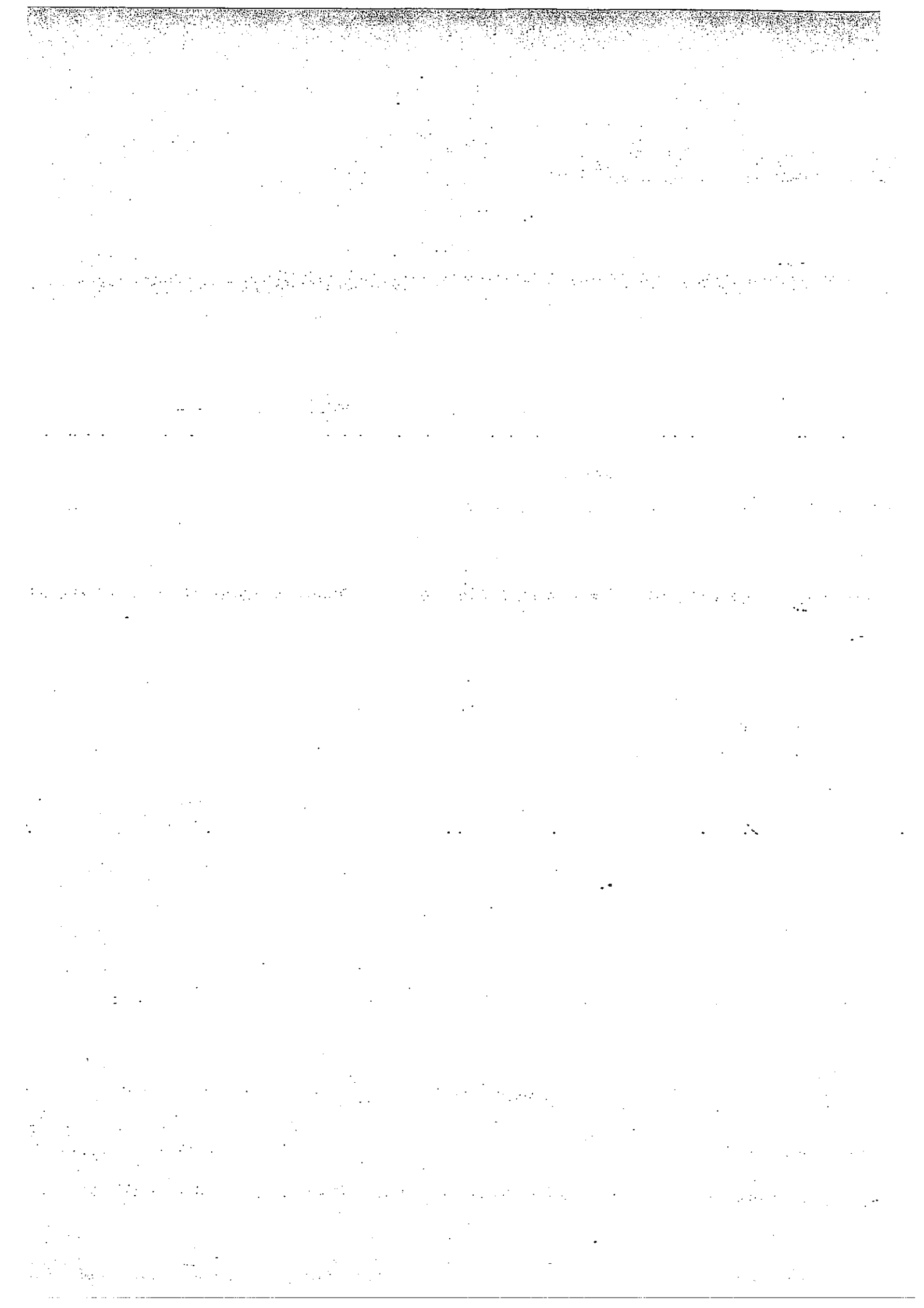

Questions 16 to 25 carry 1 mark each. Write your answers in the spaces provided. For questions which require units, give your answers in the units stated.

(10 marks)

Do not write
in this space

16. What is the length of the pencil as shown in the figure below?

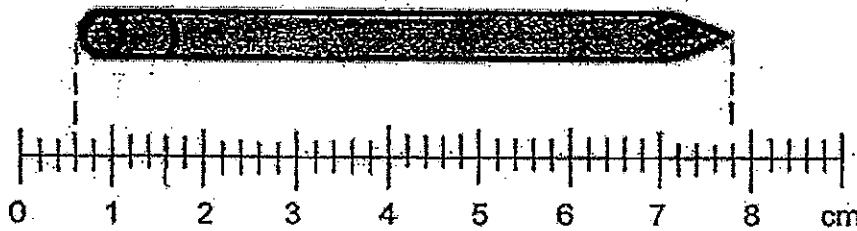

Ans: _____ cm

17. Express $7\frac{3}{8}$ litres in ml.

Ans: _____ ml

18. Find the smallest whole number that gives 4 000 when rounded off to the nearest hundred.

Ans: _____

19. In the figure below, ABC is a straight line. Given that $AB = \frac{3}{4}AD$,

what is the area of the triangle BCD?

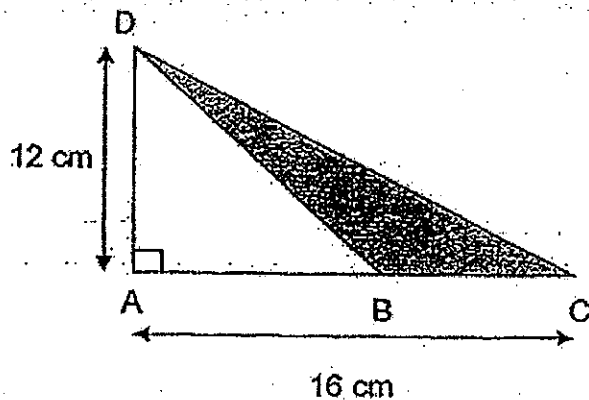

Ans: _____ cm^2

20. Find the perimeter of a quarter circle with radius 21 cm.

(Take $\pi = \frac{22}{7}$)

Ans: _____ cm

21. What is the missing number in the box?

$$8 : 28 = \boxed{?} : 63$$

Ans: _____

Do not write
in this space

22. Express 5.88 as a mixed number in the simplest form.

Do not write
in this space

Ans: _____

23. $\frac{2}{5}$ of Amy's savings is equal to $\frac{3}{7}$ of Marilyn's savings.
Amy's savings is \$75. What is Marilyn's savings?

Ans: \$ _____

24. Shade two more unit squares to make the figure symmetrical about the line XY.

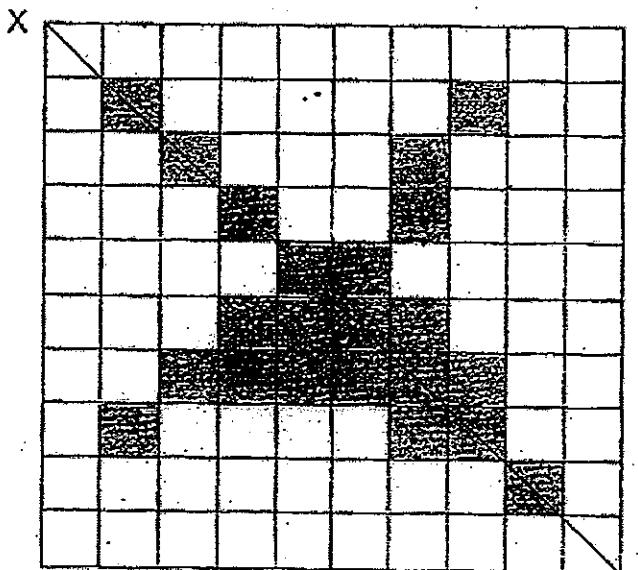

25. The pattern in the box shows part of a tessellation. Extend the tessellation by drawing two more unit shapes in the space provided in the box.

Do not write in this space

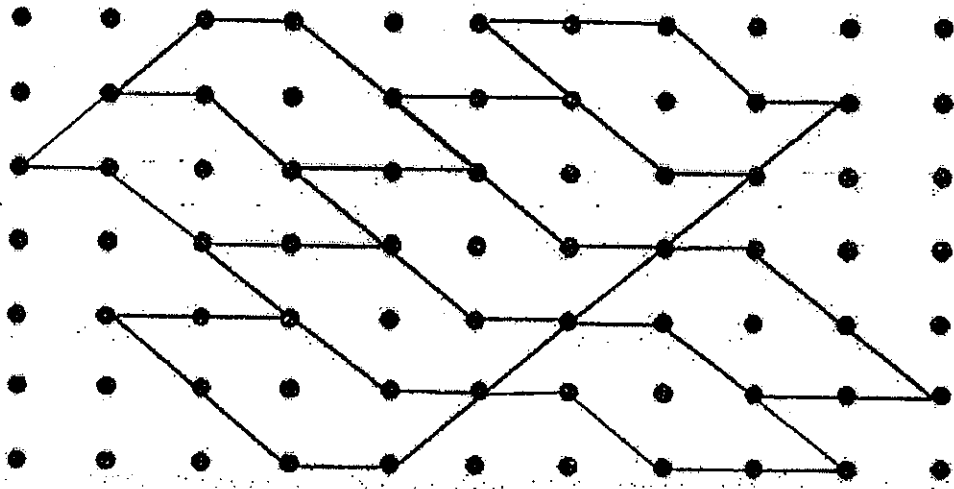

Questions 26 to 30 carry 2 marks each. Show your workings clearly in the space provided for each question and write your answers in the spaces provided. For questions which require units, give your answers in the units stated.

(10 marks)

Do not write
in this space

26. The table below shows the sale of tickets for a school musical concert. Study the table carefully and answer the question.

Category	Ticket Prices (in dollars)	Number of tickets sold
A	30	150
B	35	130
C	40	90
D	45	30
E	50	11

Which category of tickets fetched the greatest amount of money?

Ans: _____

27. The figure below is not drawn to scale. Find the value of y .

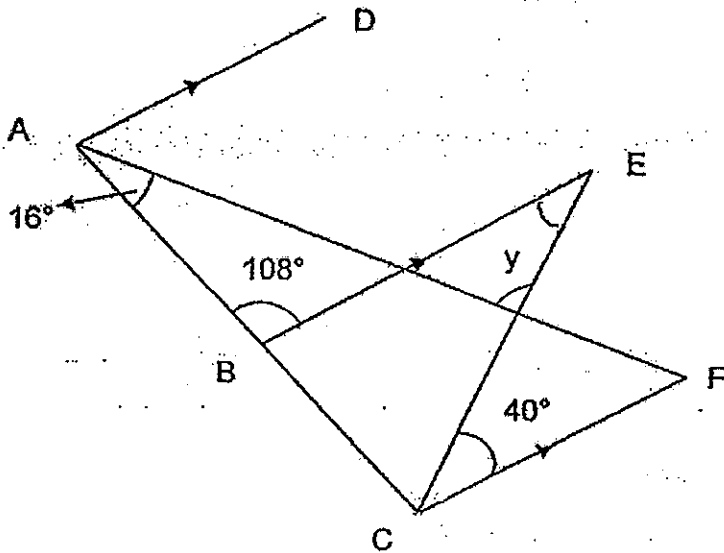

Do not write
in this space

Ans: _____ $^\circ$

28. The average of 8 consecutive even numbers is 85.
What is the smallest number among the 8 numbers?

Ans: _____

29. 55% of the beads in a bag are red. The rest are blue and green beads in the ratio of 3 : 2. There are 196 more red than blue beads. How many beads are there in the bag altogether?

Do not write
in this space

Ans: _____

30. Jonah had $\$w$ at first. He spent half of the money on lunch and bought 8 pens at $\$1.50$ each. How much money had he left? Express your answer in terms of w .

Answer: \$ _____

End of Paper

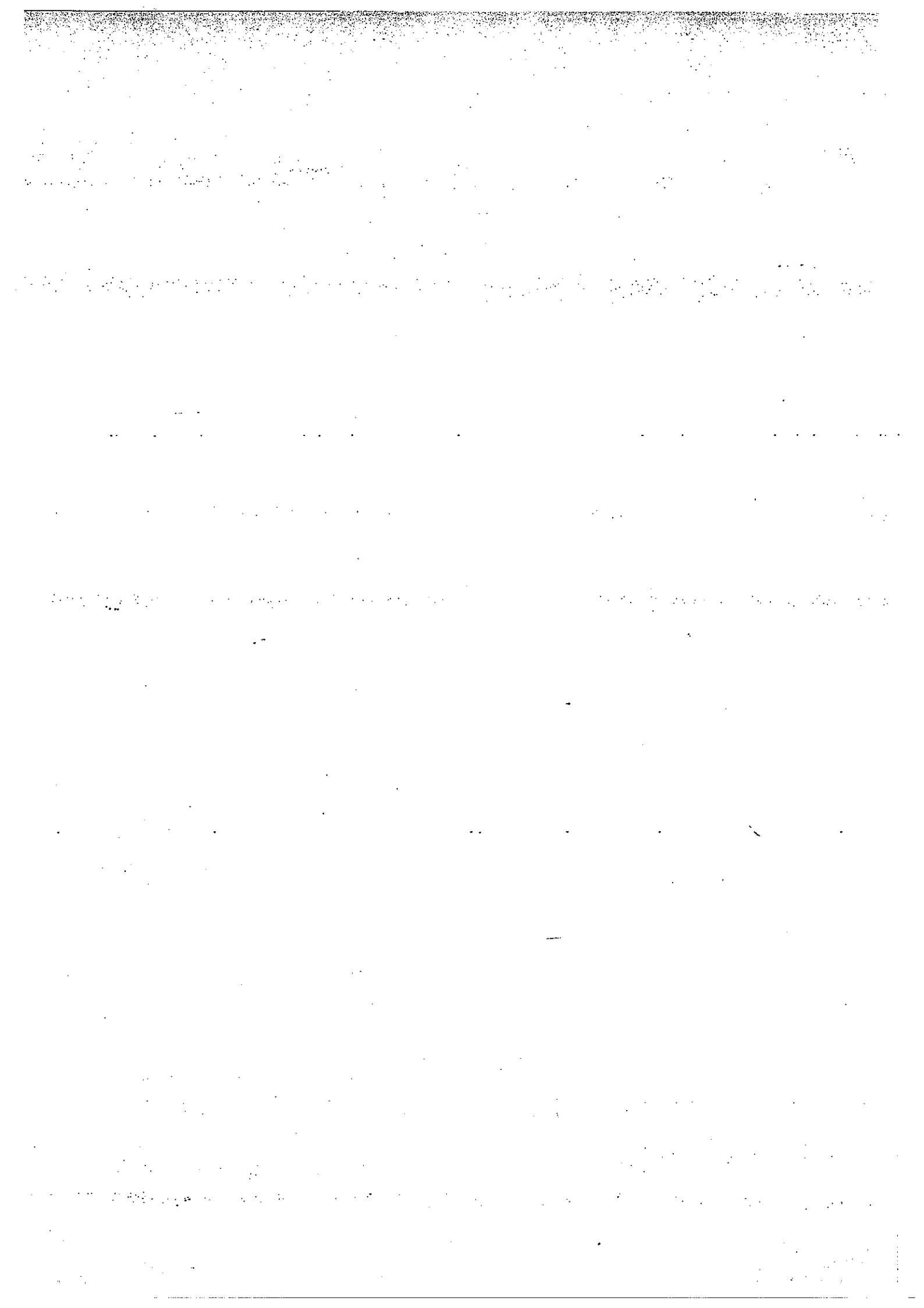



Rosyth School
Preliminary Examination 2012
Primary 6 Mathematics

Name: _____

Register No. _____

Class: Pr 6- _____

Date: 23 August 2012

Parent's Signature: _____

Time: 1 h 40 min

PAPER 2

Instructions to Pupils:

1. Do not open this booklet until you are told to do so.
2. Follow all instructions carefully.
3. **Show your workings clearly** as marks are awarded for correct working.
4. Write your answers in this booklet.
5. You are allowed to use a calculator
6. Answer all questions.

Questions	Maximum Mark	Marks Obtained
Q 1 to 5	10	
Q 6 to 18	50	

Section	Maximum Mark	Marks Obtained
Paper 1	40	
Paper 2	60	
Total	100	

* This booklet consists of 18 pages (excluding this cover page)
This paper is not to be reproduced in part or whole without the permission of the Principal.

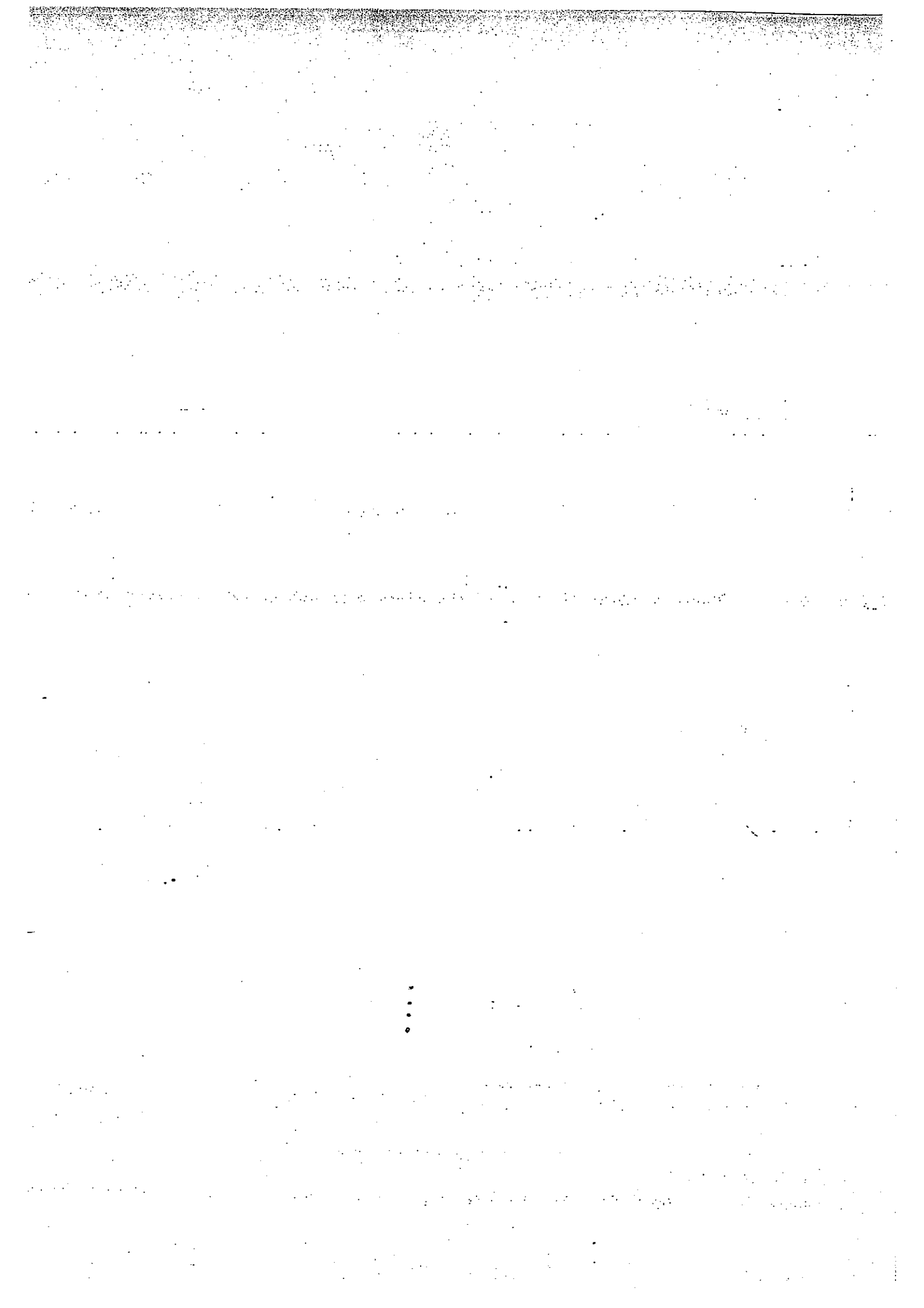

Questions 1 to 5 carry 2 marks each. Show your working clearly in the space provided for each question and write your answers in the spaces provided. For questions which require units, give your answers in the units stated.

Do not write in this space

(10 marks)

- 1) The line graph below shows the change in the merchandise export of country Y for the past 5 years. Study the graph and answer questions (a) and (b).

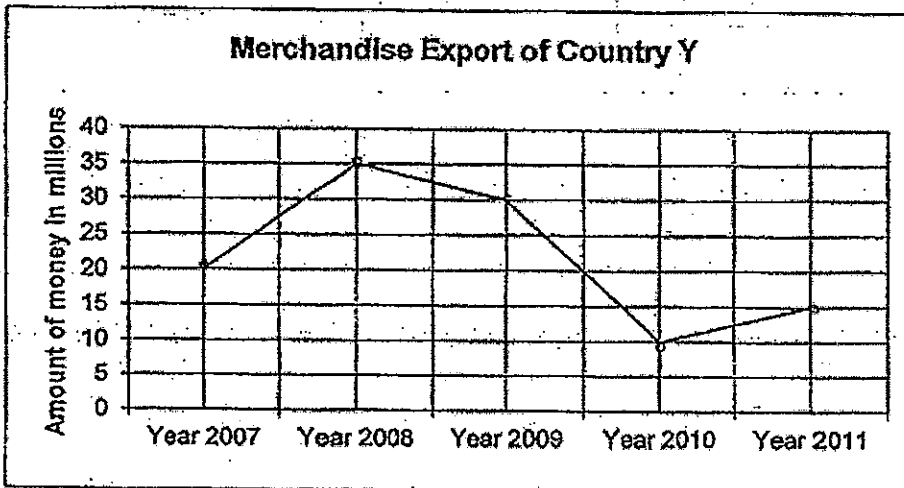

- a) What is the value of country Y's export in the year 2008?

Answer : \$ _____ [1m]

- b) During which one-year period was the increase in the amount of money the greatest?

Answer : From _____ to _____ [1m]

2) Two different brands of rice are on promotion at a supermarket.

Do not write
in this space



BRAND A
Fragrant rice
5 kg @ \$18.40
per packet



BRAND B
Fragrant rice
10 kg @ \$34.50
per packet

Special offer for
Brand B
Buy 2 get 1 free !

Mrs Lim wants to buy 40 kg of rice. How much will she save if she buys Brand B rice instead of Brand A rice?

Answer : \$ _____

(Go on to the next page)

3) The length and breadth of a rectangle is 20 cm and 16 cm respectively.

When the length is increased by 15% and its area is increased by $43\frac{3}{4}\%$,

what is the new breadth?

Do not write
in this space

Answer : _____ cm

- 4) The figure is made up of a square and a circle. O is the centre of the circle. What is the area of the shaded region given that triangle FOG has an area of 16 cm^2 ? (Take $\pi = 3.14$)

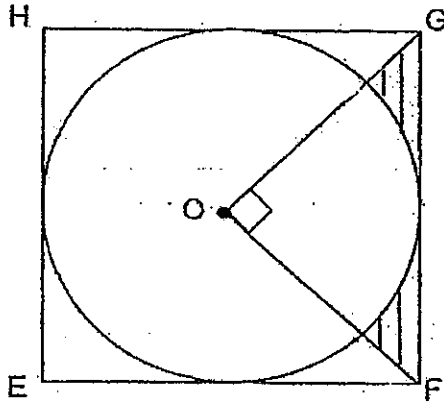

Do not write
in this space

Ans: _____ cm^2

5) The pie chart below shows the cost of 4 types of toys.

Do not w
in this sp

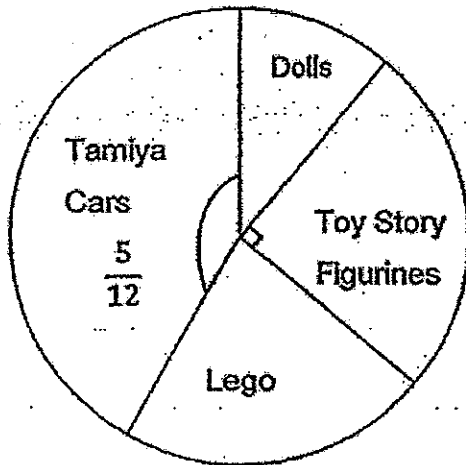

Item	Cost (\$)
Dolls	100
Toy Story Figurines	?
Lego	200
Tamiya Cars	?

What is the cost of the Tamiya Cars?

Ans: \$ _____

Questions 6 to 18, show your working clearly in the space provided for each question and write your answers in the spaces provided. The number of marks available is shown in brackets [] at the end of each question or part-question. (50 marks)

Do not write in this spaces

- 6) The figure below is not drawn to scale. It shows two identical right-angled triangles ABC , DEC and a square $GHFC$. $\angle GCD = 42^\circ$ and $\angle FCB = 35^\circ$. Find $\angle ACE$.

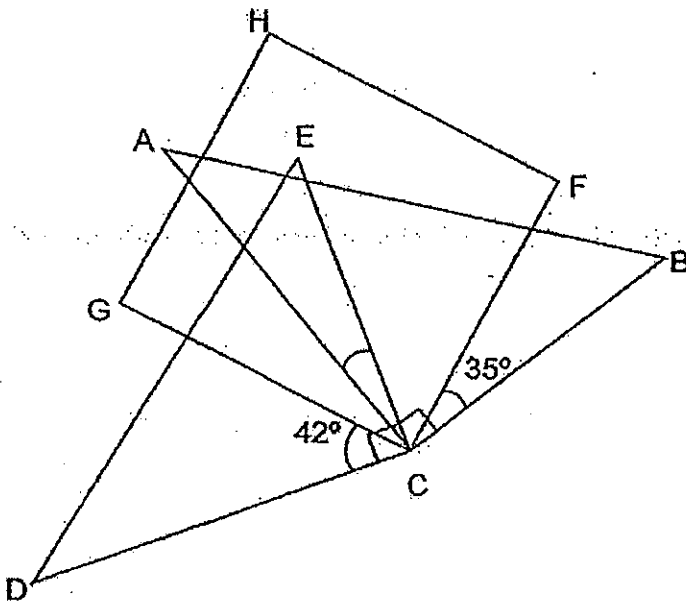

Ans: _____ [3m]

- 7) The tickets for a circus show are priced at \$150 and \$88. The ratio of the number of \$150 tickets to the number of \$88 tickets is $2 : 3 \frac{3}{4}$ of the \$150 tickets and all the \$88 tickets were sold. The ticket sales amounted to \$78 240. How much more would have been collected if all the tickets were sold?

Do not write
in this space

Ans: _____ [3m]

- 8) The ratio of Iskandar's savings to Norman's savings is 2 : 3. They spent \$865 each on a present for a friend. After that, Iskandar's savings is $\frac{2}{5}$ of Norman's savings. How much did Norman save at first?

Do not write
in this space

Ans: _____ [3m]

- 9) Joseph has four times as many stickers as Kumar. If Joseph gives Kumar 12 stickers, Joseph will be left with 18 more stickers than Kumar. Find the total number of stickers the two boys have.

Do not write
in this space

Ans: _____ [3m]

- 10) Tank X measuring 50 cm long, 24 cm wide and 60 cm high was completely filled with water. Tank Y measuring 75 cm long, 24 cm wide and 40 cm high was empty. When water was poured from Tank X to Tank Y without spilling, the heights of the water level in the 2 tanks became the same. Find the amount of water that was poured from Tank X to Tank Y.

Do not write
in this space

Ans: _____ [3m]

- 11) Wendy has big and small chicken and duck eggs in her farm. She has 275 chicken eggs and 225 duck eggs. The ratio of big chicken eggs to small duck eggs is 5 : 2. The total number of big chicken eggs and big duck eggs is 300. Find the total number of small chicken eggs in her farm.

Do not write
in this space.

Ans: _____ [3m]

- 12) Mr Siew drove from Town X to Town Y at 60 km/h. If he increased his speed by 12 km/h, he would reach Town Y 1 hour earlier. Find the speed he must travel after the first 120 km so that he can reach Town Y $\frac{4}{5}$ h earlier.

Do not write
in this space

Ans: _____ [4m]

- 13) In a quiz, 4 marks were awarded for each correct answer to a question and 3 marks were deducted for each wrong answer. No points were awarded if a question was not answered. The following table shows the results of 2 children who took part in the quiz. However, some ink was spilled on the table so some of the numbers cannot be seen.

Do not write
in this space

Name	Number of Wrong Answers	Number of Questions not answered	Points Obtained
Anthony	25	0	165
Benny	13		229

- (a) How many questions were there in the quiz?
- (b) How many questions did Benny not answer?

Ans: (a) _____ [2m]

(b) _____ [2m]

- 14) Two boxes A and B contain 368 bags altogether. The ratio of the number of red bags to the number of green bags in box A is 1 : 3. The ratio of the number of red bags to the number of green bags in box B is 1 : 2. There are 264 green bags in boxes A and B altogether. How many green bags are there in box B?

Do not write
in this space

Ans: _____ [4m]

15) In the morning, the number of blueberry cupcakes baked was 50% that of strawberry cupcakes. By afternoon, 20 more blueberry cupcakes were baked while 32 strawberry cupcakes were given away. The number of blueberry cupcakes became 70% of the number of strawberry cupcakes by the afternoon.

- a) What was the number of strawberry cupcakes by afternoon?
- b) What was the number of blueberry cupcakes by afternoon?

Do not write
in this space

Ans: (a) _____ [4m]

(b) _____ [1m]

- 16) The figure below is made up of 3 identical circles and an equilateral triangle touching the points P, Q and R on the circles. Given that the area of the triangle PQR is 60 cm^2 and the diameter of the circle is 14 cm , find the area of the shaded part using the calculator value of π .
(Give your answer correct to 2 decimal places)

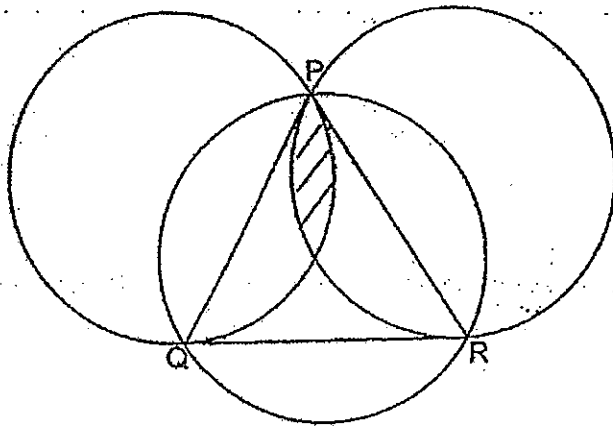

Do not write
in this space

Ans: _____ [5m]

(Go on to the next page)

17) Peter, June and Benny decided to buy a present for their grandmother. Peter agreed to contribute 25% of the cost of the present while June agreed to pay 30% of the remaining amount. The rest of the cost would be paid by Benny. When the cost of the present had increased by 20%, Benny had to pay \$100.80 for his share.

- a) What was the original price of the present?
- b) How much did June have to pay in the end?

Do not write
in this space

Ans: (a) _____ [3m]

(b) _____ [2m]

(Go on to the next page)

- 18) Two buses X and Y left ABC interchange at 6.35 a.m. to pick up passengers. They travelled at an uniform speed in opposite directions round a 55 km circular route. Bus X took 50 minutes to complete each round. After every 30 minutes, the two buses would meet. At what time would the two buses meet at the interchange again?

Do not write
in this space.

Ans: _____ [5m]

End of Paper

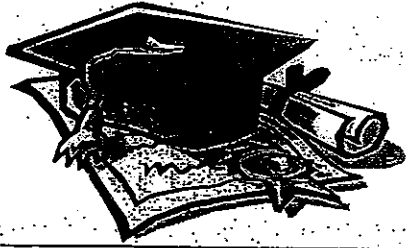

ANSWER SHEET

EXAM PAPER 2012

SCHOOL : ROSYTH
SUBJECT : PRIMARY 6 MATHEMATICS

TERM : SA2

Q1	Q2	Q3	Q4	Q5	Q6	Q7	Q8	Q9	Q10	Q11	Q12	Q13	Q14	Q15
3	3	1	2	1	4	2	1	1	2	3	3	4	3	3

16) 7.2cm

17) 7375ml

18) 3950

19) 42cm²

20) 75

21) 18

22) 522/25

23) \$70

24)

25)

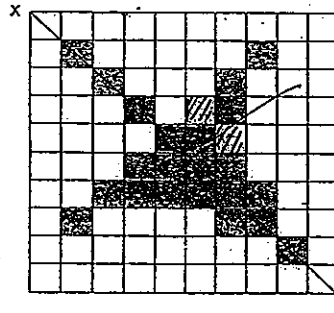
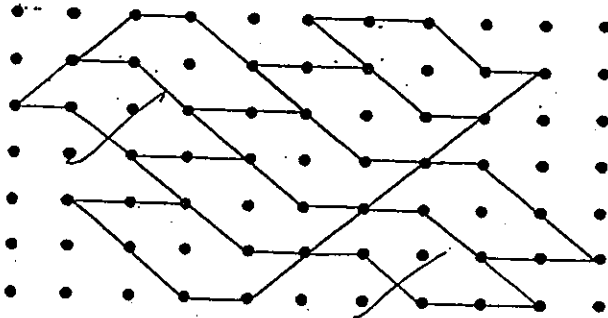

26) category B

27) 84°

28) 78

29) 700

30) \$(w/2 - \$12)

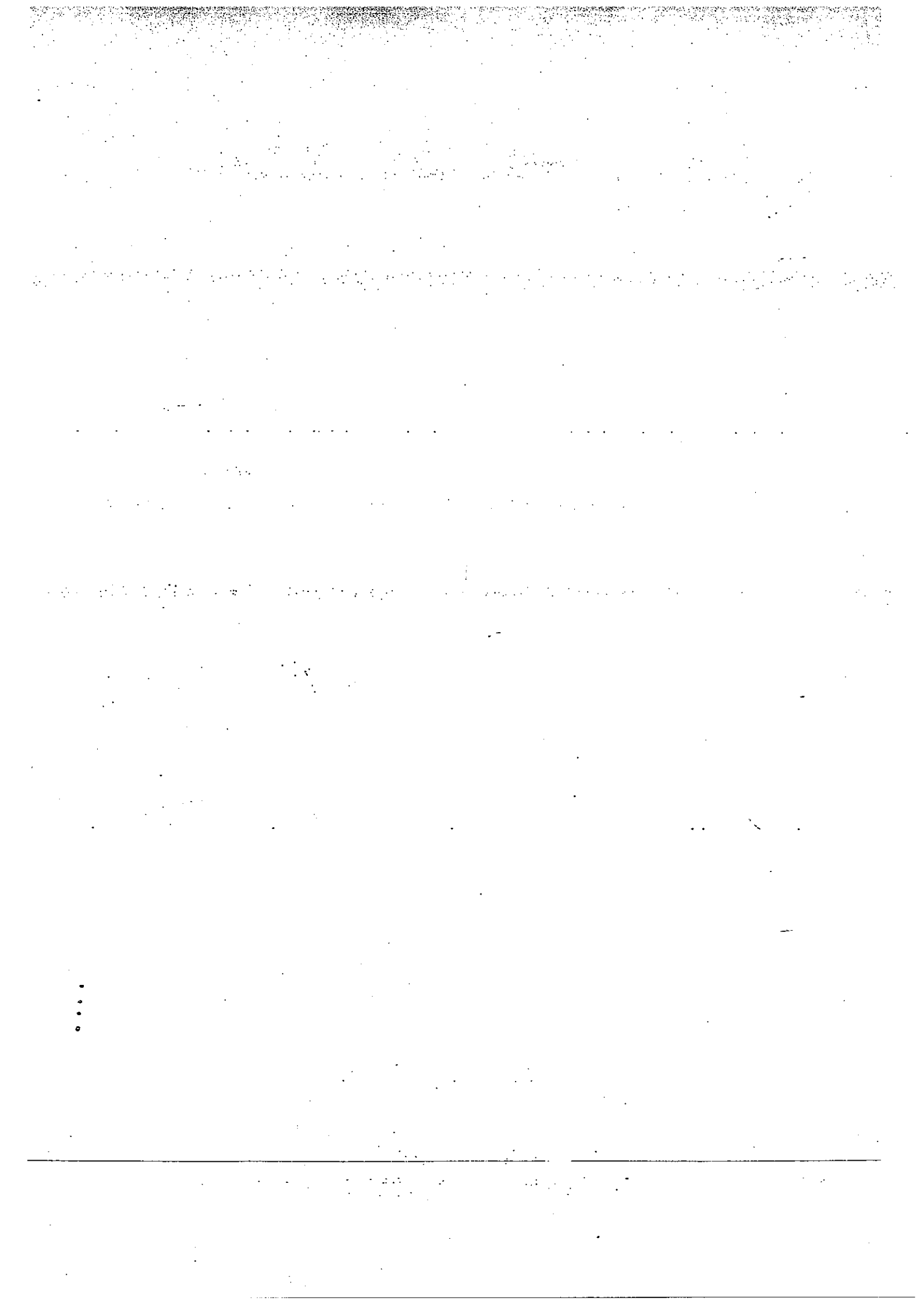



ROSYTH SCHOOL

NAME _____

CLASS _____

DATE 29/8/12

SUBJECT Math Paper 2 Corrections

GROUP _____

Year 2007 ~~#~~ → ~~20~~ 20 million

Year 2008 → 35 million

Year 2009 → 30 million

Year 2010 → 10 million

Year 2011 → 15 million

1a) Ans → \$35 million

to

1b) Ans → 2007 ~~to~~ 2008

↓

2007 to 2008 → 35 million - 20 million = 15 million → Increase

2008 ~~to~~ 2009 → 35 million - 30 million = 5 million

2009 to 2010 → 30 million - 10 million = 20 million → Decrease

2

$$\begin{aligned} \text{Brand A} & \rightarrow 5 \text{ kg} \rightarrow \$18.40 \quad \downarrow \times 8 \\ & \times 8 \downarrow 40 \text{ kg} \rightarrow 18.40 \times 8 \quad \downarrow \\ & = \$147.20 \end{aligned}$$

$$\begin{aligned} \text{Brand B} & \rightarrow 10 \text{ kg} \rightarrow \$34.50 \quad \downarrow \times 3 \\ & \times 3 \downarrow 30 \text{ kg} \rightarrow 34.50 \times 3 + 1 \text{ free} \\ & = \$103.50 \end{aligned}$$

$$\begin{aligned} \text{Savings} & \rightarrow \$147.20 - \$103.50 \\ & = \$43.70 \end{aligned}$$

Ans → \$43.70

20

16

16

20

$$L \rightarrow 100\% \rightarrow 20 \text{ cm}$$

$$\Rightarrow 115\% \rightarrow \frac{115}{100} \times 20 \\ = 23 \text{ cm}$$

$$\text{Area} \rightarrow 20 \times 16 = 320 \text{ cm}^2$$

$$100\% \rightarrow 320$$

$$143\frac{3}{4}\% \rightarrow 320 \times 143\frac{3}{4}\% \div 100\% \\ = 320 \times \frac{575}{4} \times \frac{1}{100} = 460$$

$$b = \frac{A}{L} = \frac{460}{20} = 23 \text{ cm} \\ \text{Ans} \rightarrow 20 \text{ cm}$$

$$\text{Area of square} \rightarrow 16 \times 4 = 64$$

$$\text{Side of square} \rightarrow \sqrt{64} = 8$$

$$\text{Diameter of circle} \rightarrow 8$$

$$\text{radius of circle} \rightarrow 8 \div 2 = 4$$

$$\text{Area of quadrant} \rightarrow 4 \times 4 \times 3.14 \times \frac{1}{4} \\ = 12.56$$

$$\text{shaded Area} = 16 - 12.56 = 3.44$$

$$\text{Ans} = 3.44 //$$

5. Toy story $\rightarrow \frac{1}{4}$

Tamara $\rightarrow \frac{5}{12}$

$$\text{Dolls + Lego} \rightarrow 1 - \frac{1}{4} - \frac{5}{12} = \frac{4}{12}$$

$$100 + 200 = 300$$

$$M \rightarrow 300 \div 4 = 75$$

P6 Prelim 2012
Paper 2 Answer Key

6)

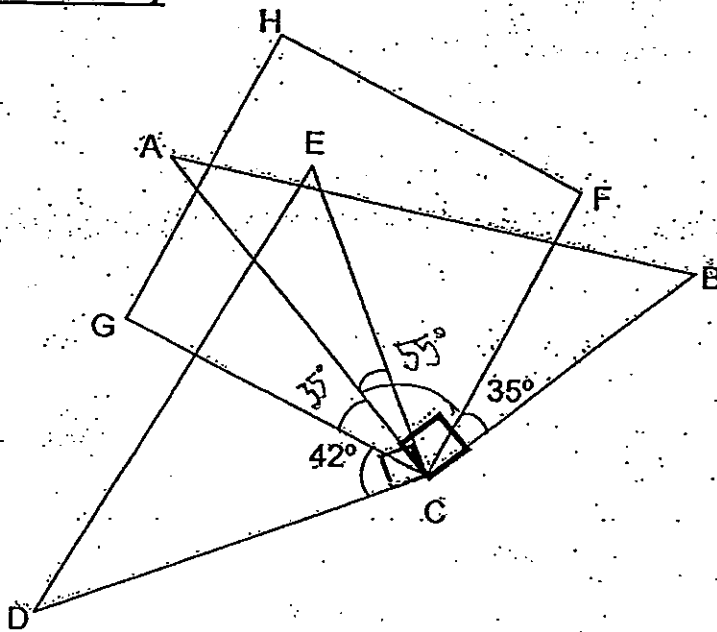

Look at Triangle ABC:

$$\angle ACF = 90^\circ - 35^\circ \text{ (Right-angled triangle ABC)}$$

$$= 55^\circ$$

Look at square CFGH:

$$\angle GCA = 90^\circ - 55^\circ \text{ (using the square)}$$

$$= 35^\circ$$

Look at triangle DEC:

$$\angle ACE = 90^\circ - 42^\circ - 35^\circ$$

$$= 13^\circ$$

Mod: Constant Difference Concept

8)	<u>Before</u>	<u>I : N</u>	<u>Difference</u>
		2 : 3	1
	<u>After</u>	2 : 5	3

Since each spent the same amount, the difference must be the same.

<u>Before</u>	<u>I : N</u>	<u>Difference</u>
	6 : 9	3
	-\$865 ↓ ↓ -\$865	
<u>After</u>	2 : 5	3

$$6 - 2 = 4 \quad 4 u \longrightarrow \$865 \quad 1 u \longrightarrow \$865 \div 4 = \$216.25$$

$$9 u \longrightarrow \$216.25 \times 9 = \underline{\underline{\$1\,946.25}}$$

9)

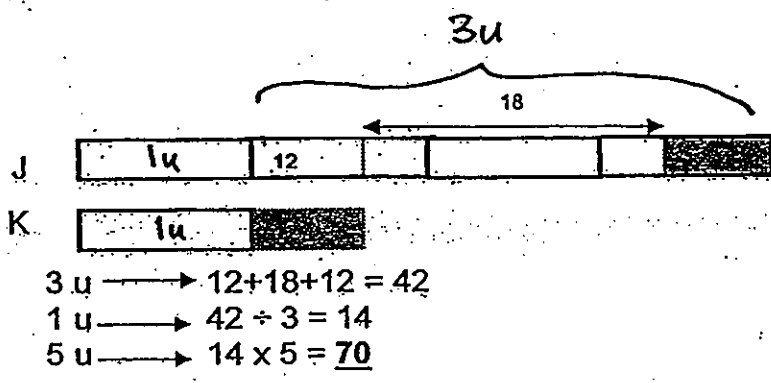

10)

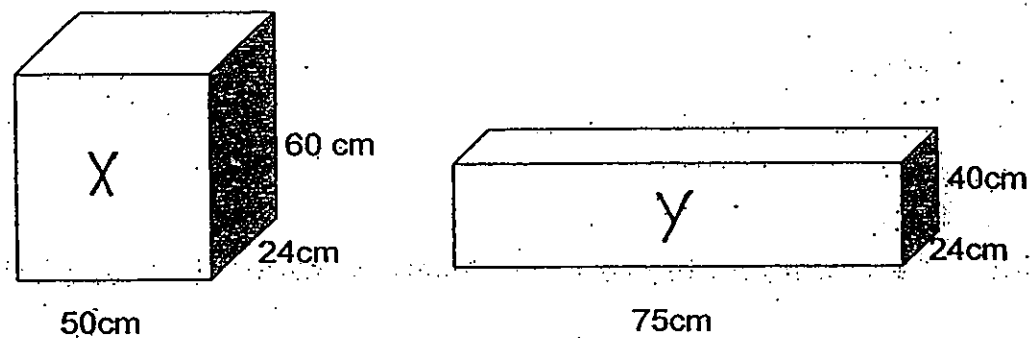

Vol of water in Tank X = $50 \text{ cm} \times 24 \text{ cm} \times 60 \text{ cm}$
 $= 72\,000$

Pour some of water from X into Y until they reach the same height in both containers
 New water level = $72\,000 \div [(50 \times 24) + (75 \times 24)] = 24$

$60 \text{ cm} - 24 \text{ cm} = 36 \text{ cm}$
 $36 \text{ cm} \times 50 \text{ cm} \times 24 \text{ cm} = \underline{43\,200 \text{ cm}^3}$

11)

	Chicken eggs	Duck eggs	Total
	275	225	500
Big	5u	300 - 5u	300
Small		2u	

Method 1:

$300 - 5u + 2u = 225$
 $3u = 75$
 $1u = 25$

$5 \times 25 = 125$ (big chicken eggs)
 $275 - 125 = \underline{150}$ (small chicken eggs)

Alternative method:

	chicken	ducks	total
total	275	225	500
No of units (simplest form) use calculator - short cut	11u	9u	20u
Big	5u	7u	300 (12u)
Small	6u	2u	

$$5u + 7u \rightarrow 12u$$

$$12u \rightarrow 300$$

$$6u \rightarrow 300 \div 2 = 150$$

12) distance travelled is the same \rightarrow inverse proportion

Old Speed : New Speed

$$60 : 72$$

$$= 5 : 6$$

Old Time : New Time

$$6 : 5$$

$$\text{Difference in time} : 6u - 5u = 1u$$

$$1 \text{ unit} = 1 \text{ hour}$$

$$6 \text{ units} = 6 \text{ hours}$$

$$\text{Total Distance travelled} = 60 \text{ km/h} \times 6 \text{ h} = 360 \text{ km}$$

$$\text{(new time)} \rightarrow 6 \text{ h} - \frac{4}{5} \text{ h} = 5\frac{1}{5} \text{ h}$$

$$\text{(Time for 120 km)} \rightarrow 120 \text{ km} \div 60 \text{ km/h} = 2 \text{ h}$$

$$\text{(time left)} \rightarrow 5\frac{1}{5} \text{ h} - 2 \text{ h} = 3\frac{1}{5} \text{ h}$$

$$\text{(Distance left)} \rightarrow 360 \text{ km} - 120 \text{ km} = 240 \text{ km}$$

$$\text{(Speed)} \rightarrow 240 \text{ km} \div 3\frac{1}{5} \text{ h} = 75 \text{ km/h}$$

- 13) (a) total marks deducted $\rightarrow 25 \times 3 = 75$
 Total marks if all correct $\rightarrow 165 + 75 = 240$
 No of qns answered correctly $\rightarrow 240 \div 4 = 60$
 Total no of qns $\rightarrow 60 + 25 = 85$

- (b) marks deducted $\rightarrow 13 \times 3 = 39$
 Marks if all qns are correct $\rightarrow 229 + 39 = 268$
 No of qn answered correctly $\rightarrow 268 \div 4 = 67$
 No of qns not answered $\rightarrow 85 - 67 - 13 = 5$

Alternative method:

60	correct qns			240m
25	wrong qns	$\times 3$	=	-75m
85	total qns			165m

$\div 4$

67	correct qns			268	m
13	wrong qns	$\times 3$	=	-39m	
	total qns			229m	

$\div 4$

$85 - 67 - 13 = 5$

14) Method 1:

Box A
R : G

Box B
R : G

$1u : 3u$

$1p : 2p$



264

$368 - 264 = 104$ (Total no. of red bags in Box A and B) (M1)

$1u + 1p = 104 \rightarrow (1)$

$(1) \times 2 \rightarrow 2u + 2p = 208 \rightarrow (2)$

$3u + 2p = 264 \rightarrow (3)$

$(3) - (2) \rightarrow u = 56$

$2(56) + 2p = 208$

$2p = 96$

Method 2:

$$\begin{array}{r} 4u + 3p \longrightarrow 368 \text{ (1)} \\ 3u + 2p \longrightarrow 264 \text{ (2)} \end{array}$$

$$\begin{array}{r} (1) \times 3: 12u + 9p \longrightarrow 1104 \\ (2) \times 4: 12u + 8p \longrightarrow 1056 \end{array}$$

$$\begin{array}{r} \text{Take the difference: } p \longrightarrow 1104 - 1056 = 48 \\ 2p \longrightarrow 48 \times 2 = \underline{96} \end{array}$$

Box A

$$\begin{array}{r} R : G : \text{Total} \\ 1u : 3u : 4u \end{array}$$

Box B

$$\begin{array}{r} R : G : \text{Total} \\ 1p : 2p : 3p \end{array}$$

15)

At first	B	S	B	S
	1u	2u	10u	14u
	+20	-32	+200	-224
At the end	7p	10p	70p	70p

$$14u - 224 = 10u + 200$$

$$4u = 424$$

$$1u = 106$$

a) Strawberry $\rightarrow 2 \times 106 = 212$
 $212 - 32 = \underline{180}$

b) Blueberry $\rightarrow 106 + 20 = \underline{126}$

$$\begin{array}{l} \text{or } 1u + 20 = 7p \quad (1) \\ 2u - 32 = 10p \quad (2) \end{array}$$

$$(1) \times 10: 10u + 200 = 70p$$

$$(2) \times 7: 14u - 224 = 70p$$

$$\begin{array}{r} \text{Take the difference: } 4u = 200 + 224 \\ = 424 \end{array}$$

$$\begin{array}{r} 1u = 424 \div 4 \\ = 106 \end{array}$$

$$\begin{array}{r} 7p = 106 + 20 \\ = \underline{126} \end{array}$$

(Blueberry cupcakes by afternoon part b answer)

$$\begin{array}{r} 10p = 126 \div 7 \times 10 \\ = \underline{180} \end{array}$$

(Strawberry cupcakes by afternoon, Part a answer)

(a) 180

(b) 126

16)

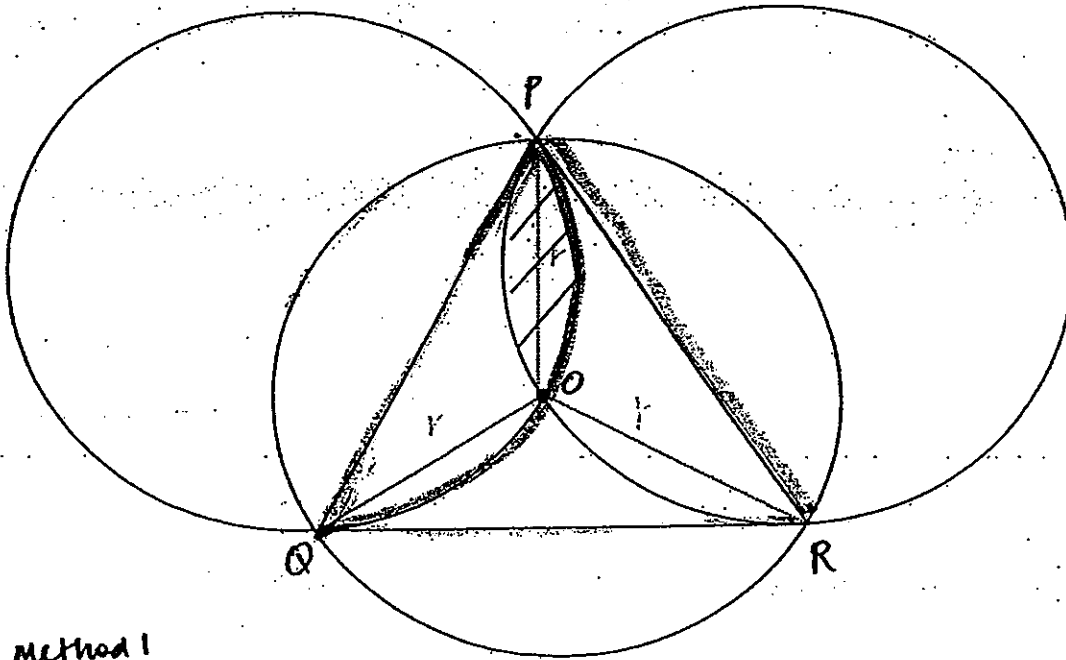

Method 1

16) Area of one small triangle = $60 \div 3 = 20$

Area of one circle = $\pi \times 7 \times 7 = 49\pi$

Area of 3 segments = circle - big Δ
 $= 49\pi - 60 = 93.93804003$

Area of 1 segment
 $= 93.93804003 \div 3 = 31.31268001$

Area of shaded part = segment - small Δ
 $= 31.31268001 \text{ cm}^2 - 20 \text{ cm}^2 = 11.31268001 \text{ cm}^2$

- O is centre of circle
- r is radius = 7cm.

$= 11.3 \text{ cm}^2$

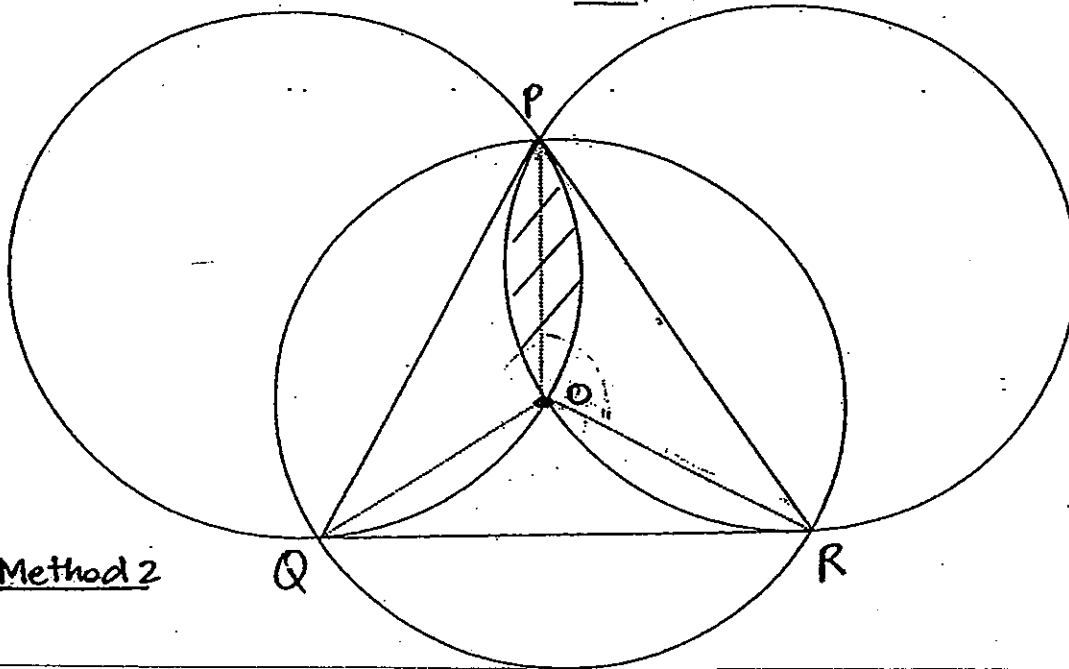

Method 2

17)

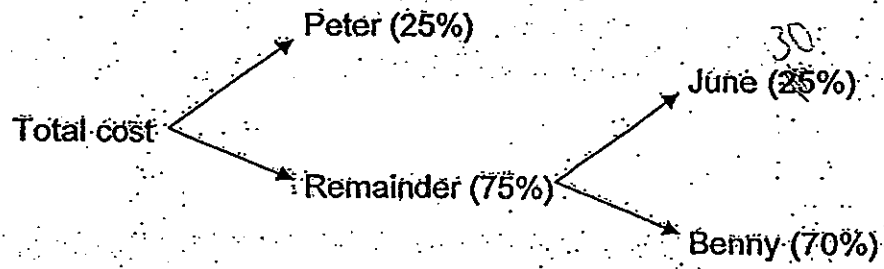

Method 1.

- Peter → 25%
- June → $30\% \times (100 - 25)\% = 22.5\%$ (of total)
- Benny → $100\% - 25\% - 22.5\% = 52.5\%$ (of total)
- 52.5% → \$100.80
- 100% → \$192
- 120% → \$192
- 100% → \$160

b) 100% → \$192
 22.5% → $\frac{\$192}{100} \times 22.5 = \underline{\$43.20}$

Method 2:

120% → \$100.80
 100% → $\frac{\$100.80}{120} \times 100 = \84 (paid by Benny at first)
 70% → \$84
 100% → $\frac{\$84}{70} \times 100 = \120 (Remainder)
 75% → \$120
 100% → $\frac{\$120}{100} \times 75 = \underline{\$160}$

b) 70% → \$100.80
 30% → $\frac{\$120}{70} \times 30 = \underline{\$43.20}$

18) Speed of bus X = $55 + \frac{50}{60} = 66$

Distance covered by bus Y = $55 - \frac{30}{60} \times 66 = 22$

Speed of bus Y = $22 + \frac{30}{60} = 44$

$66 : 44 = 3 : 2$

Starting from the interchange, they would meet again when bus X has travelled 3 rounds and bus Y has travelled 2 rounds.

Time taken by bus X = $(55 \times 3) \div 66 = 2\frac{1}{2}$

$2\frac{1}{2}$ h

6.35 a.m. → 9.05 a.m.