

Index No.

--	--	--	--	--	--	--	--	--	--



Maha Bodhi School
2015 Preliminary Examination
Primary 6
Mathematics
Paper 1
(Booklet A)

Name : _____ ()

Class : Primary 6 MA ()

Date : 14 August 2015

Total Duration for Booklets A and B: 50 min

INSTRUCTIONS TO CANDIDATES:

1. Write your Index No. in the boxes at the top right hand corner.
2. Do not turn over this page until you are told to do so.
3. Follow all instructions carefully.
4. Answer all questions.
5. Shade your answers in the Optical Mark Sheet provided.
6. The use of calculators is **NOT** allowed.

Questions 1 to 10 carry 1 mark each. Questions 11 to 15 carry 2 marks each.
For each question, four options are given. One of them is the correct answer.
Make your choice (1, 2, 3 or 4). Shade the oval (1, 2, 3 or 4) on the Optical Mark Sheet. (20 marks)
All diagrams are not drawn to scale.

1. In which one of the following numbers does the digit 8 have the largest value?

- (1) 76 589
- (2) 68 795
- (3) 579 846
- (4) 489 567

2. Express $\frac{5}{6} \div 2$ in its simplest form.

- (1) $\frac{5}{12}$
- (2) $\frac{3}{5}$
- (3) $1\frac{2}{3}$
- (4) $2\frac{2}{5}$

3. How many minutes are there in $3\frac{2}{5}$ h ?

- (1) 184 min
- (2) 204 min
- (3) 220 min
- (4) 340 min

4. Find the area of the shaded triangle.

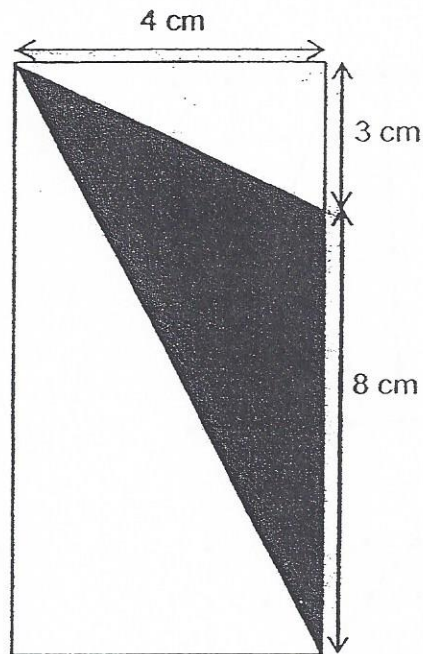

- (1) 16 cm^2
(2) 22 cm^2
(3) 32 cm^2
(4) 44 cm^2
5. 24 out of 50 pupils like ice cream while the rest of them like milkshake. Find the percentage of pupils who like milkshake.
- (1) 24%
(2) 26%
(3) 48%
(4) 52%

6. Which one of the dotted lines in the figures below is a line of symmetry?

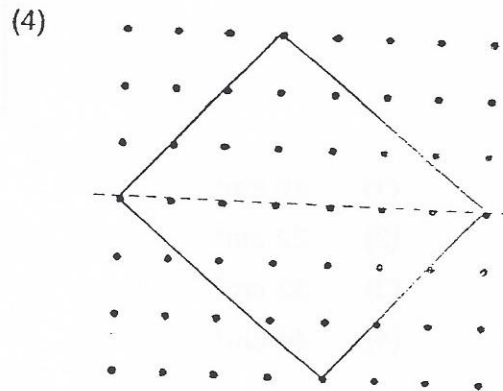
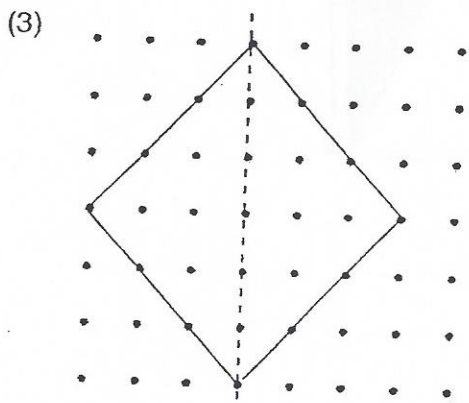
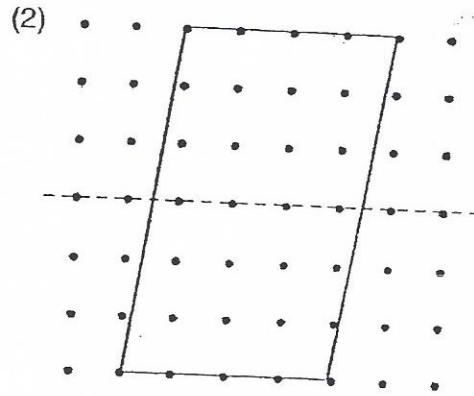
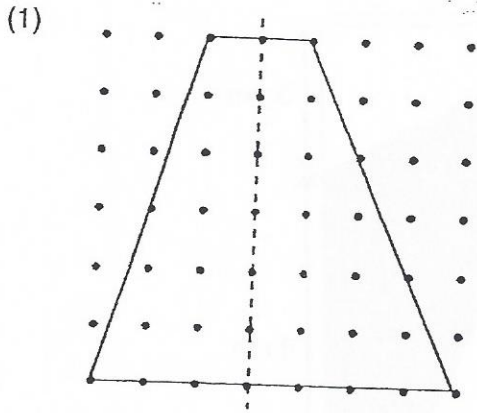

7. Square and round buttons are shown below. What is the ratio of the number of black square buttons to the total number of round buttons?

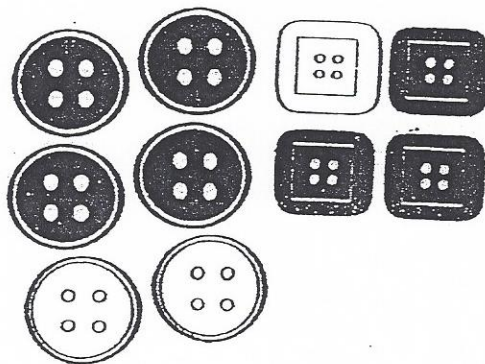

- (1) 1 : 2
- (2) 2 : 3
- (3) 3 : 4
- (4) 3 : 10

8. The bar graph below shows the time taken by 4 boys to complete a race.

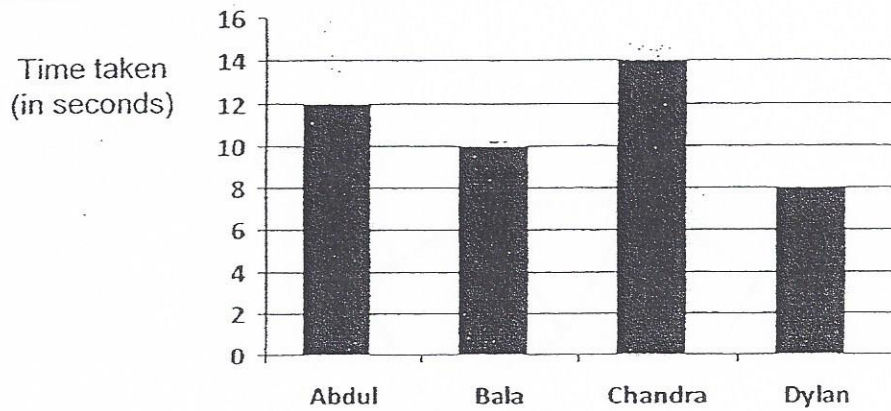

Which boy finished third in the race?

- (1) Abdul
- (2) Bala
- (3) Chandra
- (4) Dylan

9. All 36 pupils in Primary 6 Benevolence voted for the colour of their class T-shirt.

The result is shown in the pie chart below.

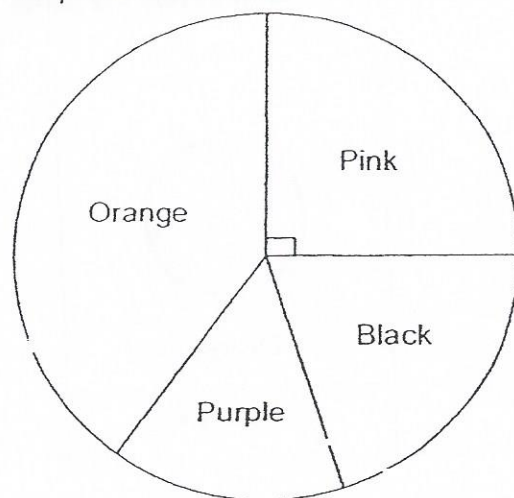

16 pupils opted for Orange. Find the total number of pupils who opted for Black and Purple.

- (1) 9
- (2) 11
- (3) 16
- (4) 20

10. 3 identical squares and 2 identical triangles were used to form the net of a solid as shown below.

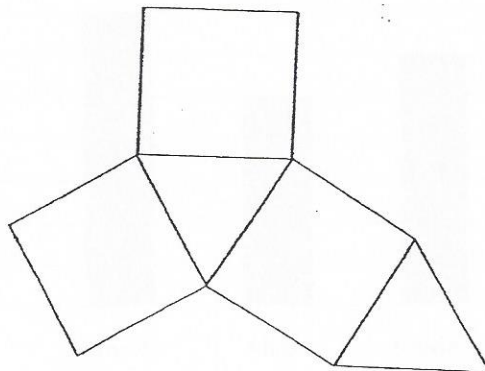

4 statements were used to describe it. Which statement is correct?

- (1) The prism has 5 faces.
 - (2) This is a net of a pyramid.
 - (3) The solid figure formed has 10 corners.
 - (4) A cube can be formed with 3 such solids.
11. To make a fruit salad, Mdm Norah needed to buy the same number of apples and oranges.

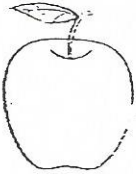
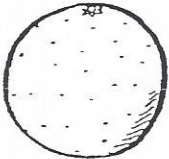
	
Apple	Orange
6 for \$2	4 for \$3

What was the least amount she could have spent?

- (1) \$12
- (2) \$13
- (3) \$24
- (4) \$26

12. A motorist travelled at 60 km/h for the first $\frac{1}{6}$ h. Then he travelled at 90 km/h for another $\frac{1}{3}$ h. What was the total distance he travelled?
- (1) 28 km
 - (2) 40 km
 - (3) 75 km
 - (4) 150 km
13. Mr Lim bought $\frac{2}{3}$ kg of grapes. He ate $\frac{1}{4}$ of the grapes and gave the remainder equally to his 5 sisters. How many kilograms of grapes did each sister receive?
- (1) $\frac{1}{2}$ kg
 - (2) $\frac{3}{20}$ kg
 - (3) $\frac{1}{12}$ kg
 - (4) $\frac{1}{10}$ kg
14. What is the difference between 13 tens and 13 tenths?
- (1) 11.7
 - (2) 12.87
 - (3) 128.7
 - (4) 129.87
15. A basin was $\frac{3}{8}$ filled with water. 600 ml of water was added and it became half full. How much water was there in the basin at first?
- (1) 375 ml
 - (2) 450 ml
 - (3) 1800 ml
 - (4) 4800 ml

1. The first part of the document is a list of names and their corresponding addresses.

2. The second part of the document is a list of names and their corresponding addresses.

(1)
(2)
(3)
(4)

3. The third part of the document is a list of names and their corresponding addresses.

4. The fourth part of the document is a list of names and their corresponding addresses.

(5)
(6)
(7)
(8)

5. The fifth part of the document is a list of names and their corresponding addresses.

6. The sixth part of the document is a list of names and their corresponding addresses.

(9)

7. The seventh part of the document is a list of names and their corresponding addresses.

8. The eighth part of the document is a list of names and their corresponding addresses.

(10)
(11)
(12)
(13)

Index No.

						-	
--	--	--	--	--	--	---	--



Maha Bodhi School
2015 Preliminary Examination
Primary 6
Mathematics
Paper 1
(Booklet B)

Name : _____ ()

Marks:

20

Class : Primary 6 MA ()

Date : 14 August 2015

Total Duration for Booklets A and B: 50 min.

INSTRUCTIONS TO CANDIDATES:

1. Write your Index No. in the boxes at the top right hand corner.
2. Do not turn over this page until you are told to do so.
3. Follow all instructions carefully.
4. Answer all questions.
5. Write all your answers in this booklet.
6. The use of calculators is **NOT** allowed.

Questions 16 to 25 carry 1 mark each. Write your answers in the spaces provided.
For questions which require units, give your answers in the units stated. (10 marks)
All diagrams are not drawn to scale.

16. Express 0.875 as a fraction in its simplest form.

Ans: _____

17. Find the diameter of the coin.



Ans: _____ cm

18. The figure below is a parallelogram.

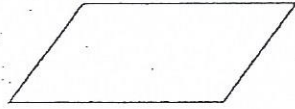

How many of the figures in the box below are also parallelograms?

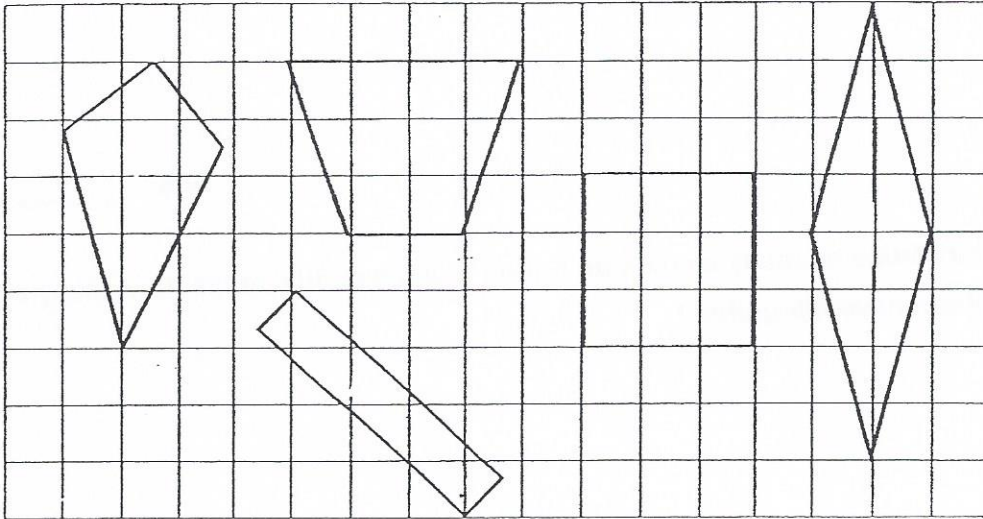

Ans: _____

19. At the zoo, Ahmad made a half-turn, followed by another 135° to his left to face the lion enclosure.

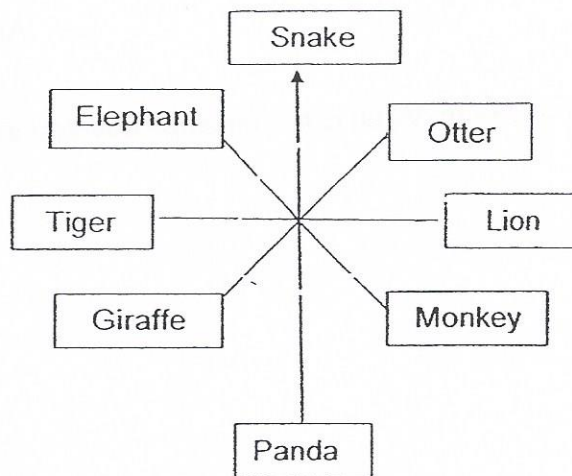

Which enclosure was Ahmad facing before he made any turn at all?

Ans: _____

20. Simplify $13h + 5 - 4h \times 3$.

Ans : _____

21. Joo has thrice as many stamps as Koon. If Joo has 36 stamps, how many stamps do Joo and Koon have altogether?

Ans: _____ stamps

22. A wheel has a radius of 21 cm. What is the distance covered if it makes 10 revolutions?

(Take $\pi = \frac{22}{7}$)

Ans: _____ cm

23. The picture graph shows the number of participants who took part in Game A, Game B and Game C at a school carnival. It cost the same amount of money to take part in any of the 3 games.

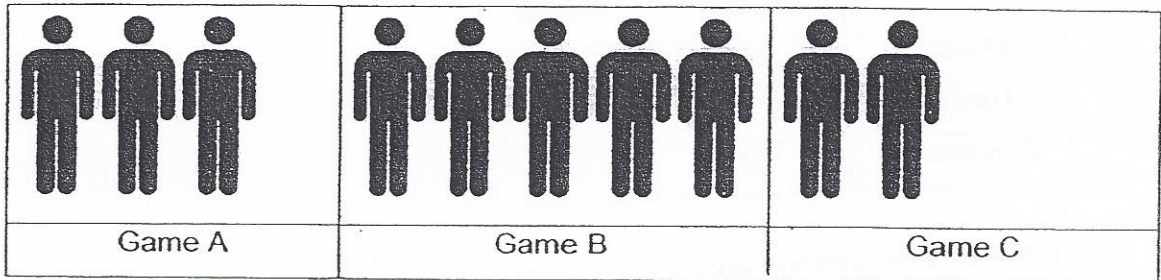

Each  represents 10 participants

The total amount collected in Game B was \$300 more than in Game A. How much money did each participant pay per game?

Ans: \$ _____

24. Alison bought some potato chips at \$3 per packet. She gave the cashier \$50 and received \$y change. Express the number of packets of potato chips she bought in terms of y.

Ans: _____ packets

25. Susan was given the same amount of pocket money each day from Monday to Wednesday. She recorded the amount she spent and saved for the 3 days. The table below shows what she had recorded.

	Spent	Saved
Monday	\$2	\$3
Tuesday		\$0.50
Wednesday	\$4	\$1

What was the average amount she spent on each of the 3 days?

Ans : \$ _____

Questions 26 to 30 carry 2 marks each. Show your working clearly in the space below each question and write your answers in the spaces provided.
 For questions which require units, give your answers in the units stated. (10 marks)

26. In the figure below, ABCD is a square. Find the area of the unshaded part.
 Leave your answer in terms of π .

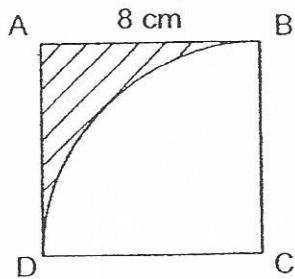

Ans: _____ cm^2

27. A carton of milk is shown below. Mrs Tan ordered 24 litres of Baa Goat's milk. As a Baa Goat member, she was given a 10% discount. How much did she pay for her order if a carton of milk cost \$18.50?



Ans: \$ _____

28. The figure below is made up of 2 identical rectangles. The shaded part is a rectangle measuring 8 cm by 3 cm. What fraction of the figure is shaded?
Express your answer in its simplest form.

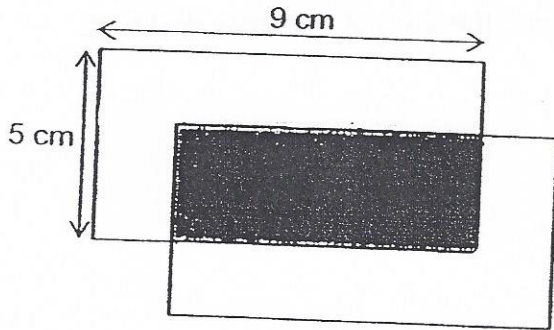

Ans: _____

29. A tank contains a rock as shown below. The volume of the rock is 600 cm^3 . Water flowed from a tap into the tank at a rate of 3 litres per minute. It took 5 minutes for the tap to completely fill up the tank. What is the height of the tank?

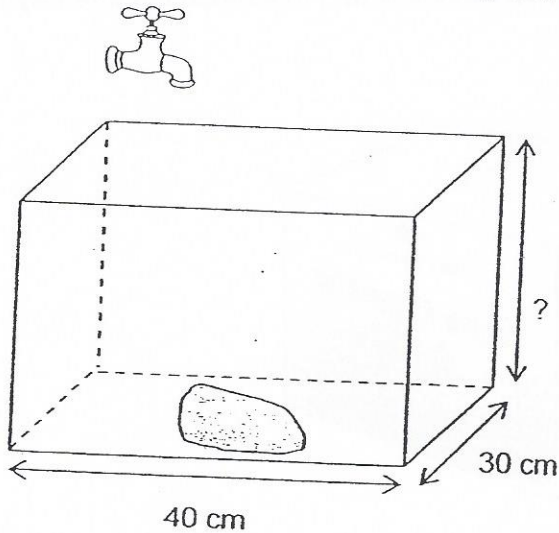

Ans: _____ cm

30. The diagram below is made up of 2 triangles and 3 identical rectangles.

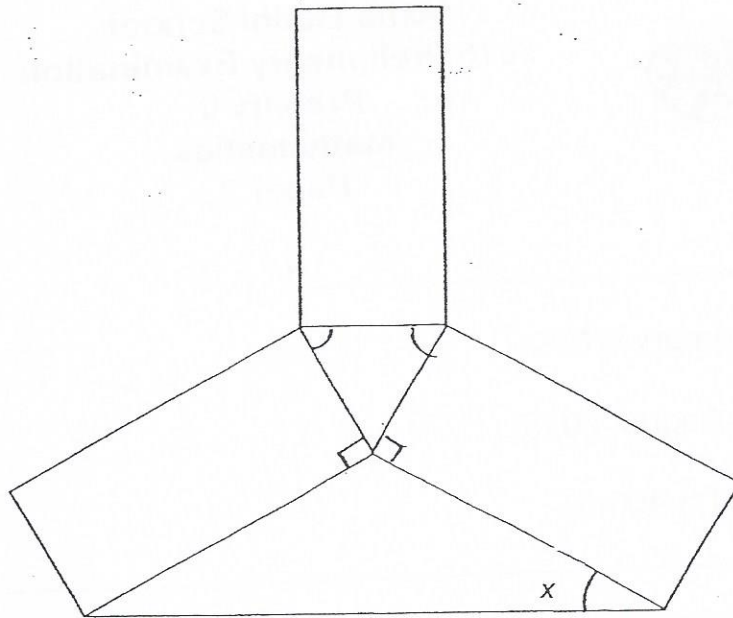

Find $\angle x$.

Ans : _____^o

Index No.



Maha Bodhi School
2015 Preliminary Examination
Primary 6
Mathematics
Paper 2

Name : _____ (.)

Class : Primary 6 MA ()

Date : 14 August 2015

Duration: 1 h 40 min

INSTRUCTIONS TO CANDIDATES:

1. Write your Index No. in the boxes at the top right hand corner.
2. Do not turn over this page until you are told to do so.
3. Follow all instructions carefully.
4. Answer all questions.
5. Write your answers in this booklet.
6. The use of an approved calculator is expected, where appropriate.

Paper	Booklet	Marks Obtained	Max Marks
1	A		20
	B		20
2	-		60
Total			100

Parent's signature: _____

This booklet consists of 15 printed pages.

Questions 1 to 5 carry 2 marks each. Show your working clearly in the space below each question and write your answers in the spaces provided.

For questions which require units, give your answers in the units stated. (10 marks)

1. Jerry and Cindy shares $\$(3x - 5)$. Jerry gets $\$x$ more than Cindy.
How much does Cindy get if $x = 6$?

Ans: \$ _____

2. The ratio of the number of members in Club M to that of Club N is 2 : 3.
The number of members in Club P is twice that of Club M and there are 20 more members in Club P than in Club N.
How many members are there in Club P?

Ans : _____ members

3. For every 3 stamps Jiahui gave to Ryan, he would always give 1 back to her.
At first, Ryan had 10 stamps more than Jiahui.
Find the difference between the number of stamps they had in the end after Jiahui had given 12 stamps to Ryan.

Ans: _____ stamps

4. A piece of wire, forming 2 identical semi-circles as shown in Figure 1, was straightened and bent into a square as shown in Figure 2. Find the area of the square, giving your answer to 2 decimal places. (Take $\pi = 3.14$)

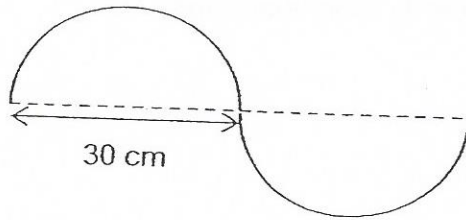

Figure 1

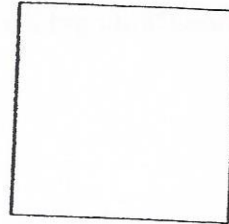
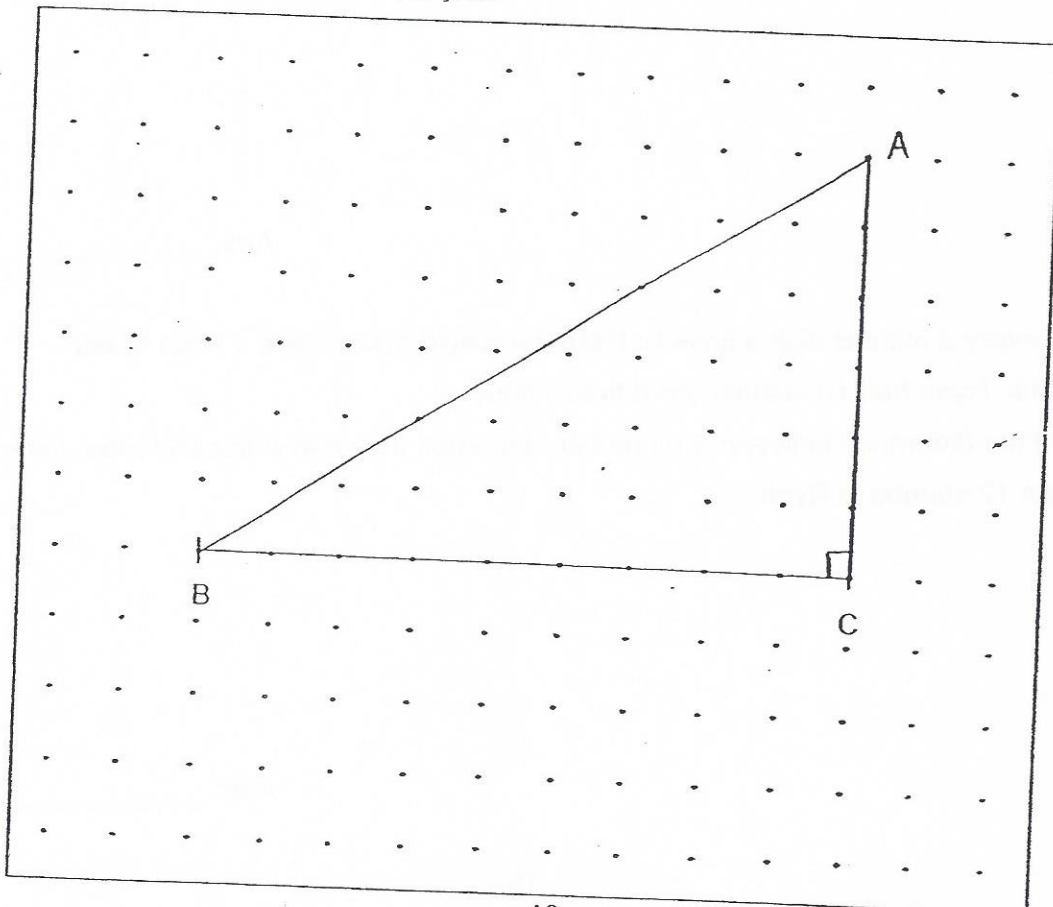

Figure 2

Ans : _____ cm^2

5. Using only the dots provided in the space below, construct Triangle ABC such that $BC = 3$ units, $AC = 2$ units and $\angle ACB = 90^\circ$.

The line BC has been drawn for you.



For questions 6 to 18, show your working clearly in the space provided for each question and write your answers in the spaces provided. The number of marks available is shown in brackets [] at the end of each question or part-question. (50 marks)

6. Find the area of the shaded parts.

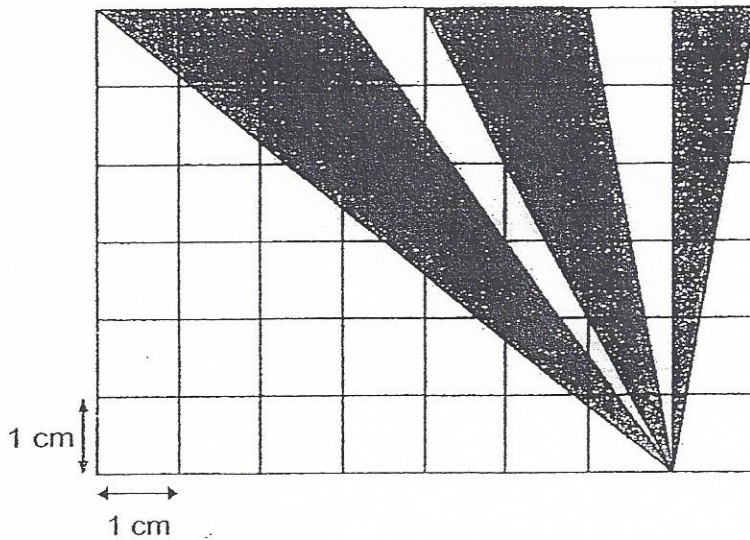

Ans: _____ [3]

7. The figure below is not drawn to scale. ABCD is a trapezium and CDEF is a parallelogram. Find $\angle BCF$.

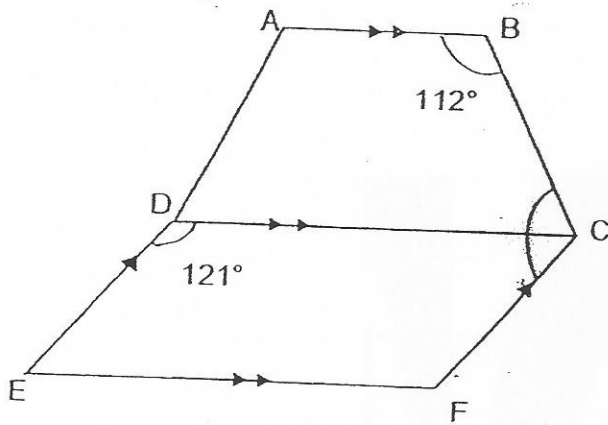

Ans: _____ [3]

8. A rectangular tank measures 75 cm by 51 cm by 30 cm. It is filled with water to a height of 15 cm. Rashid wants to fill the tank with water to the brim by pouring water from a completely filled 15-cm cubical container. If each time he pours water from the completely filled cubical container to the tank, what is the least number of times he had to pour to fill the tank to the brim?

Ans: _____ [4]

9. A crate that was $\frac{1}{2}$ filled with cups was 6.9 kg. It was 1.8 kg heavier than the same crate that was $\frac{1}{3}$ filled with the same kind of cups.

- (a) What was the mass of the empty crate?
- (b) What was the mass of a full crate of cups?

Ans: (a) _____ [3]

(b) _____ [1]

10. There were 180 girls and 150 boys in the Arts Theatre and 210 girls and 560 boys in the School Hall at first. After some boys and girls moved from the School Hall to the Arts Theatre, there were an equal number of boys and girls in the Arts Theatre and thrice as many boys as girls in the School Hall.

How many boys and how many girls were moved from the School Hall to the Arts Theatre?

Ans: Boys : _____

Girls : _____ [4]

11. Fatimah was given \$5 pocket money every day. The line graph below shows the total amount of savings she had at the end of each day for a particular week.

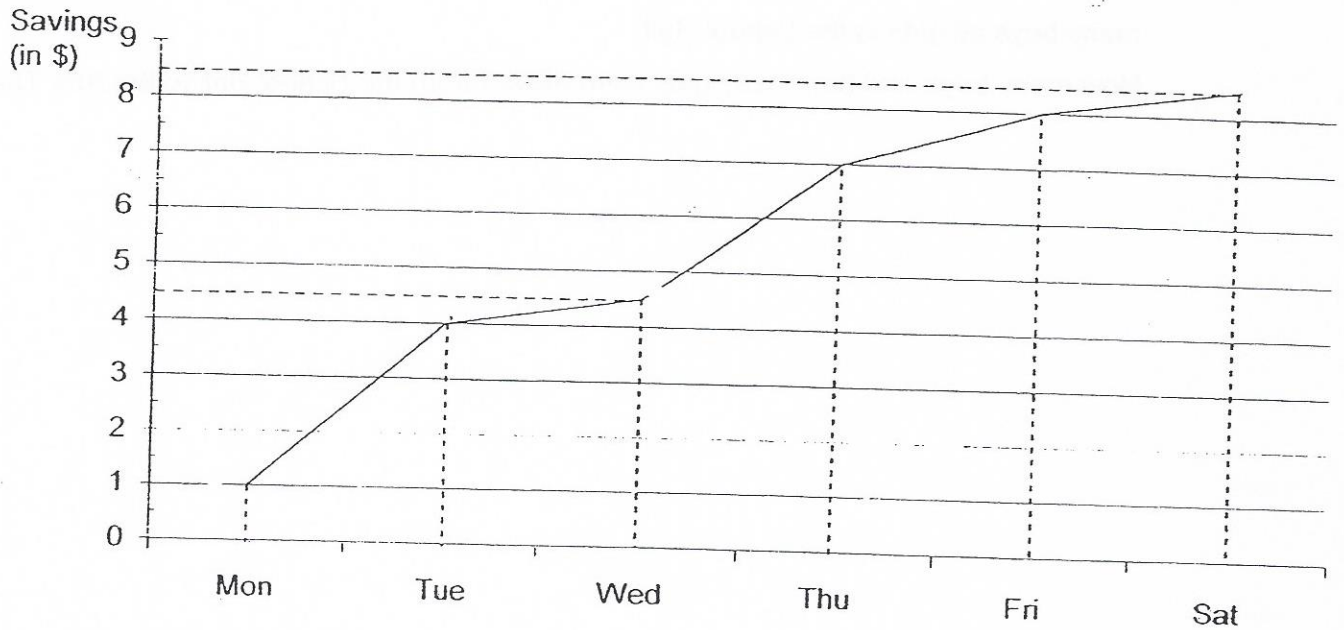

- (a) How much did Fatimah spend on Monday?
- (b) On which two days did Fatimah save the same amount of money?
- (c) What was the average amount she saved from Tuesday to Saturday?

Ans: (a) _____ [1]

(b) _____ [1]

(c) _____ [2]

12. Weibin has 2 pieces of tape with the length as shown below.

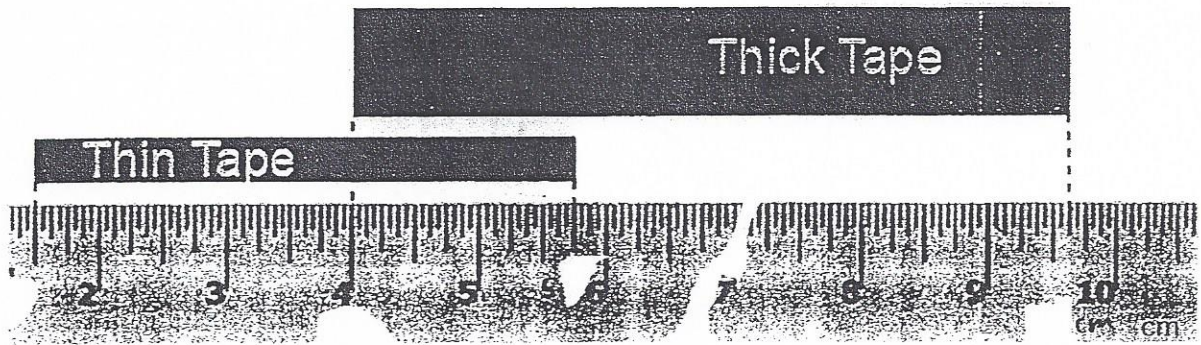

- (a) Write down the length of the thick tape.
- (b) Express, as a decimal, the difference between their lengths, correct to 2 decimal places.

Ans: (a) _____ [1]

(b) _____ [2]

13. In the figure shown below, O is the centre of the circle. $OS = ST$ and ROT is a straight line.

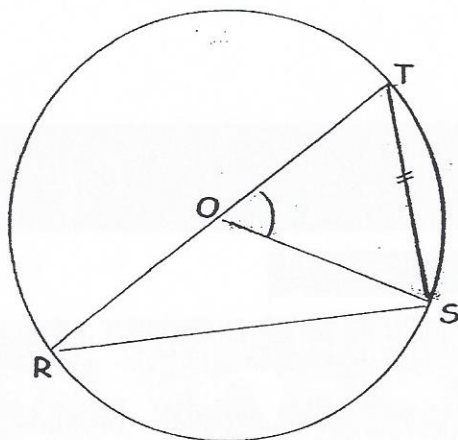

- (a) Find $\angle TOS$.
(b) Find $\angle TRS$.

Ans: (a) _____ [1]
(b) _____ [2]

14. Bob and Dylan started cycling from the same place and at the same time but in opposite directions along a straight path. After cycling for 45 min, they were 20 km apart. Bob cycled at an average speed of 12 km/h. What was Dylan's average cycling speed?
Express your answer as a mixed number in the simplest form.

Ans : _____ [3]

15. A farmer had some geese and ducks.
If he bought another 40 ducks, the ratio of the number of ducks to the number of geese would become 5 : 6.
If he bought another 60 geese instead, then the ratio of the number of ducks to the number of geese would become 2 : 3.
How many more geese than ducks did the farmer have?

Ans : _____ [4]

16. Three children, Sally, Lynn and Penny have different amounts of money.
The amount of money Lynn has is the total of Sally and Penny's amount.
The amount of money Penny has is the total of Sally's amount and half of Lynn's amount.
Sally has \$14.
- (a) How much does Lynn have?
(b) How much do these three children have altogether?

Ans : (a) _____ [2]

(b) _____ [3]

17. The figure below shows a quadrant and a semicircle enclosed within a square. O is the centre of the square. The square has a length of 12 cm.
- (a) Find the area of the shaded part.
- (b) Find the perimeter of the shaded part.
- (Take $\pi = 3.14$)

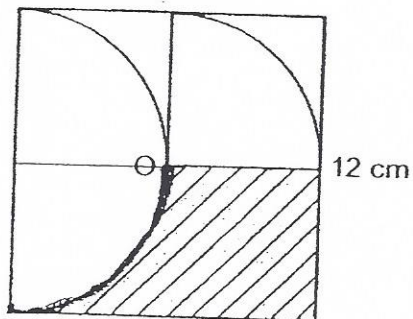

Ans : (a) _____ [3]

(b) _____ [2]

18. Martin withdrew 33% of his savings from the bank. He spent \$548 on a mobile phone and the remaining \$46 on some phone accessories. After receiving his salary, he deposited 25% of it into the bank. As a result, he had \$3480 in the bank. What was Martin's salary?

Ans: _____ [5]



Remember to check your work! Every mark counts.

–End of Paper –

15

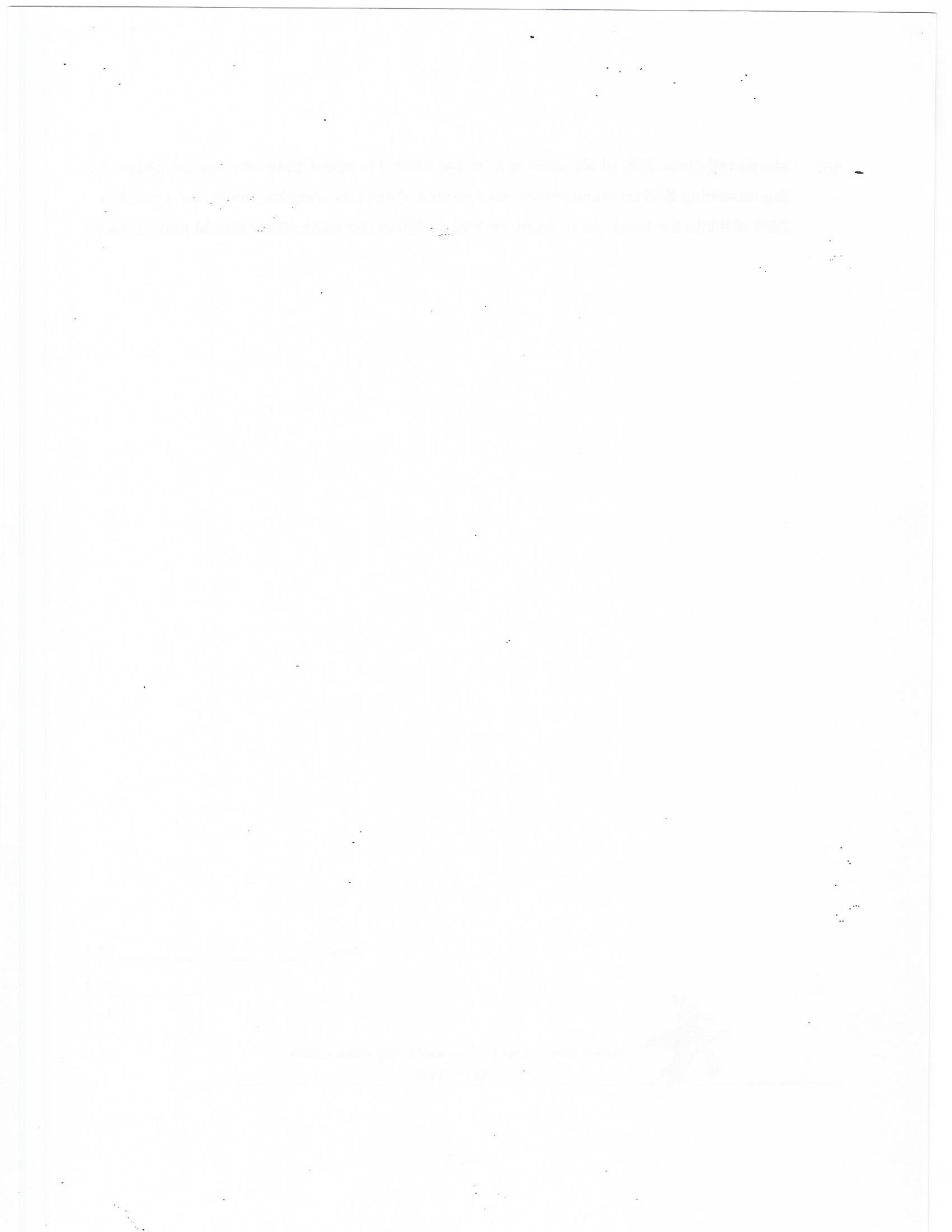

EXAM PAPER 2015
 LEVEL : PRIMARY 6
 SCHOOL : MAHA BODHI SCHOOL
 SUBJECT : MATHS
 TERM : PRELIMINARY EXAMINATION

PAPER ONE

Q1	Q2	Q3	Q4	Q5	Q6	Q7	Q8	Q9	Q10
4	1	2	1	4	3	1	1	2	1
Q11	Q12	Q13	Q14	Q15					
2	2	4	3	3					

Q16. $\frac{7}{8} \rightarrow 0.875 = \frac{875}{1000} = \frac{175}{200} = \frac{7}{8}$

Q17. 3.6cm

Q18. 3

Q19. Otter.

Q20. $(h + 5) \rightarrow 13h + 5 - 4h \times 3, 13h + 5 - 12h, h + 5$

Q21. 48 stamps $\rightarrow 36 + 12 = 48$

Q22. 1320cm $\rightarrow \frac{22}{7} \times 42 = 22 \times 6 = 110 + 22 = 132, 132 \times 10 = 1320$

Q23. \$15

Q24. $(\frac{50-4}{3})$ packets. $\rightarrow 50-y \div 3 = \frac{50-y}{3}$

Q25. \$3.50 $\rightarrow \$2 + \$4 + \$4.50 = \$10.50, \$10.50 \div 3 = \3.50

Q26. $(16\pi) \rightarrow 8 \times 8 = 64, \pi \times 8 \times 8 = 64\pi, 64\pi \div 4 = 16\pi.$

Q27. \$33.30 $\rightarrow 18.50 \times 2 = 37, 37 \div 10 = 3.7, 37 \div 10 = 3.7, 37 - 3.7 = 33.3$

Q28. $\frac{4}{11} \rightarrow \frac{24}{66} \quad \frac{12}{33} \quad \frac{4}{11}$

Q29. 13cm $\rightarrow 3000 \times 5 = 15000, 15600 \div (40 \times 30) = 13$

Q30. 30°. SEE PICTURE

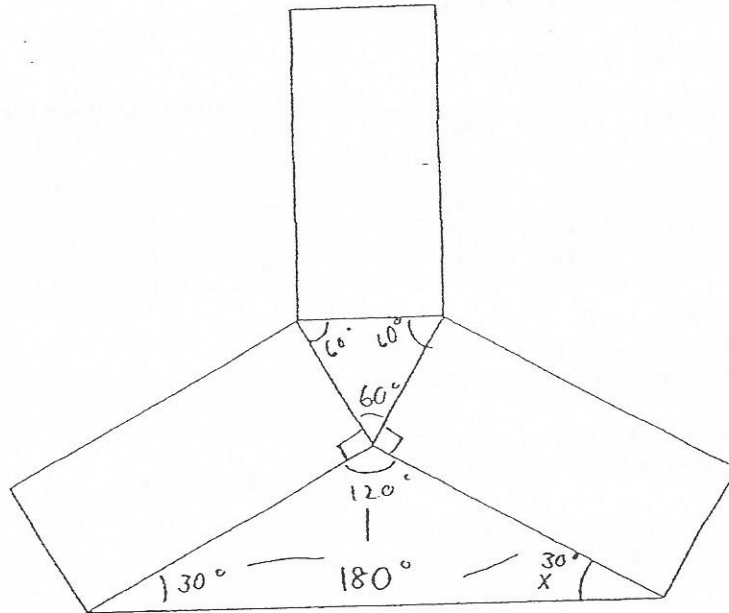

PAPER 2

Q1. \$3.50 $\rightarrow 3 \times 6 = 18, 18 - 5 = 13, 13 - 6 = 7, 7 \div 3 = 3.5$

Q2. 80 members $\rightarrow 2 \times 2 = 4, 1 \text{ unit} = 20, 4 \text{ units} = 80$

Q3. $26 \rightarrow 12 \div 3 = 4, 12 - 4 = 8, 8 + 8 + 10 = 26$

Q4. $554.60 \text{ cm}^3 \rightarrow 3.14 \times 30 = 94.2, 94.2 \div 4 = 23.55, 23.55 \times 23.50 = 554.6025, \approx 554.60$

Q5. SEE PICTURE

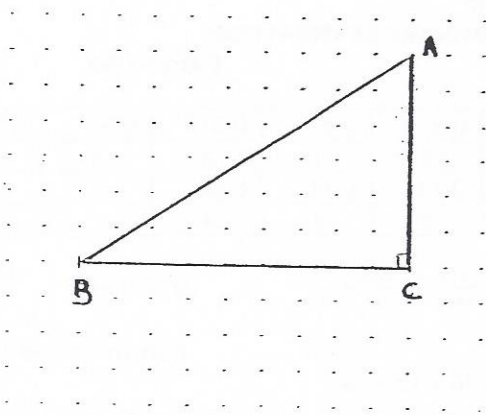

Q6. $18 \text{ cm}^2 \rightarrow \frac{1}{2} \times 3 \times 6 = 9, \frac{1}{2} \times 2 \times 6 = 6, \frac{1}{2} \times 1 \times 6 = 3, 9 + 6 + 3 = 18$

Q7. $127^\circ \rightarrow \angle DCF = 180^\circ - 121^\circ = 59^\circ, \angle BCD = 180^\circ - 112^\circ = 68^\circ, \angle BCF = 68^\circ + 59^\circ = 127^\circ, \angle BCF \text{ is } 127^\circ$

Q8. 17 times $\rightarrow 75 \times 51 \times 15 = 57375, 15 \times 15 \times 15 = 3375, 75 \times 51 \times 30 = 114750, 114750 - 57375 = 57375, 57375 \div 3375 = 17$

Q9a. $1.5 \text{ kg} \rightarrow \frac{1}{2} = \frac{3}{6}, \frac{1}{3} = \frac{2}{6}, 1.8 \times 3 = 5.4, 6.9 - 5.4 = 1.5$

Q9b. $12.3 \text{ kg} \rightarrow 1.8 \times 6 = 10.8, 10.8 + 1.5 = 12.3$

Q10. Boys: 80 Girls: 50

At first		After		Moved from school hall to arts theatre	
Girls	Boys	Girls	Boys	Girls	Boys
180	150	200	200	20	50
180	150	220	220	40	70
180	150	240	240	60	90
180	150	230	230	50	80

Q11a. $\$4 \rightarrow 5 - 1 = 4$

Q11b. Monday and Friday

Q11c. $\$1.50 \rightarrow 3 + 0.5 + 2.5 + 1 + 0.5 = 7.5, 7.5 \div 5 = 1.5$

Q12a. $5.625 \text{ cm} \rightarrow 9.625 - 4 = 5.625$

Q12b. $1.38 \text{ cm} \rightarrow 5.75 - 1.5 = 4.25, 5.625 - 4.25 = 1.375 \approx 1.38$

Q13a. $60^\circ \rightarrow \angle TOS = 180^\circ \div 3 = 60^\circ$

Q13b. $30^\circ \rightarrow \angle TRS = 180^\circ - 120^\circ \div 2 = 30^\circ$

Q14. $14\frac{2}{3} \text{ km/h} \rightarrow 12 \div 60 \times 45 = 9, 20 - 9 = 11, 11 \div 45 \times 60 = 14\frac{2}{3}$

Q15. $120 \rightarrow 40 \times 2 = 80, 80 \times 5 = 400, 400 - 40 = 360, 360 \div 2 \times 3 = 540, 540 - 60 = 480, 480 - 360 = 120$

Q16a. $\$56 \rightarrow 14 \times 3 = 42, 42 + 14 = 56$

Q16b. $\$112 \rightarrow 14 + 56 + 42 = 112$

Q17a. $43.74 \text{ cm}^2 \rightarrow 12 \times 12 = 144, 144 \div 2 = 72, 3.14 \times (12 \div 2) \times (12 \div 2) = 113.04, 113.04 \div 4 = 28.26, 72 - 28.26 = 43.74$

Q17b. $33.42 \text{ cm} \rightarrow 3.14 \times 12 = 37.68, 37.68 \div 4 = 9.42, 9.42 + 6 + 6 + 12 = 33.42$

Q18. $\$9096 \rightarrow 548 + 46 = 594, 594 \div 33 \times (100 - 33) = 1206, 3480 - 1206 = 2274, 2274 \times 4 = 9096$

THE END