

SINGAPORE CHINESE GIRLS' SCHOOL (PRIMARY)

PRIMARY SIX PRELIMINARY ASSESSMENT 2015

NAME: _____ ()

DATE: _____

CLASS: PRIMARY

Parent's Signature:

SCIENCE
BOOKLET A

30 questions

60 marks

Total time for Booklets A & B: 1 h 45 min

DO NOT OPEN THIS BOOKLET UNTIL YOU ARE TOLD TO DO SO.

FOLLOW ALL INSTRUCTIONS CAREFULLY.

Part I (60 marks)

For each question from 1 to 30, four options are given. One of them is the correct answer. Make your choice (1, 2, 3 or 4). **Shade the correct oval (1, 2, 3 or 4) on the Optical Answer Sheet.**

1.

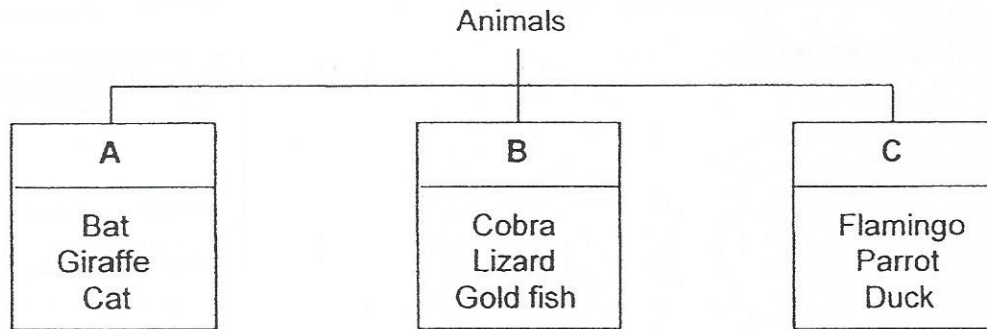

Which of the following shows how the above animals are classified?

- (1) Type of habitat
- (2) Method of breathing
- (3) Type of outer body covering
- (4) Method of reproduction

2. The following diagram shows the human digestive system.

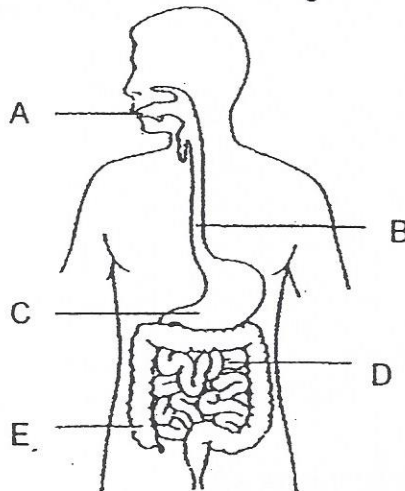

Which of the following correctly matches the part to its function?

	Absorption of food	Absorption of excess water	Digestion of food
(1)	C and E only	A only	C only
(2)	D only	E only	A, C and D only
(3)	C only	D and E only	A only
(4)	E only	D only	C only

3. Study the flow chart below.

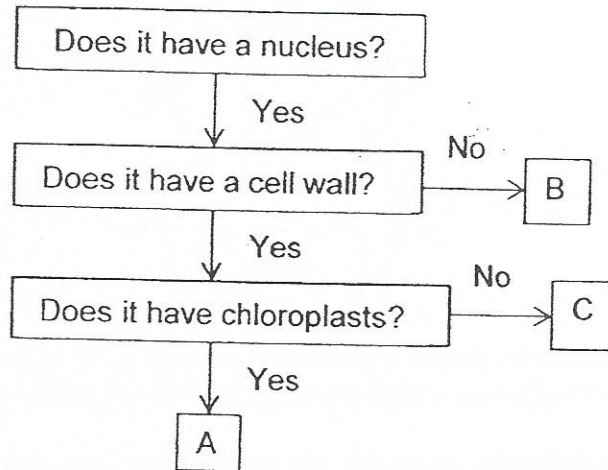

Which of the following is correct?

	Plant Cells	Animal Cells
(1)	A and C	B
(2)	B and C	A
(3)	A	B and C
(4)	A and B	C

4. Elise placed a potted plant in a sealed transparent container and 2 frogs in another sealed transparent container as shown below. The set-ups below were placed in a brightly lit place.

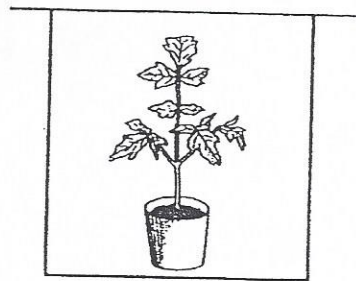

Set-up A

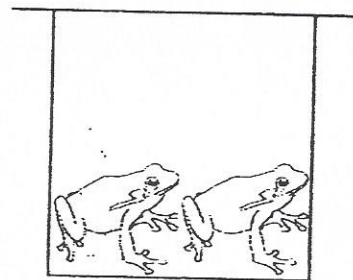

Set-up B

Which of the following shows how the amount of gases in the 2 containers changed after half an hour?

	Set-up A			Set-up B		
	Oxygen	Carbon dioxide	Water vapour	Oxygen	Carbon dioxide	Water vapour
(1)	Increase	Decrease	Decrease	Increase	Increase	Decrease
(2)	Decrease	Increase	Increase	Decrease	Increase	Increase
(3)	Increase	Decrease	Increase	Increase	Decrease	Increase
(4)	Increase	Decrease	Increase	Decrease	Increase	Increase

5. The diagram below shows the human circulatory system.

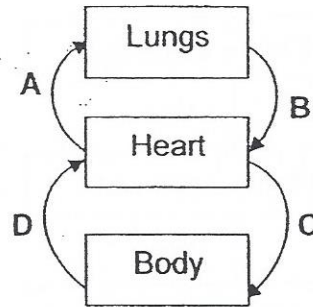

Blood samples were taken from blood vessels A, B, C and D to find out the proportion of oxygen and carbon dioxide in the human circulatory system.

Which of the following correctly shows the blood vessels where the blood samples were taken from?

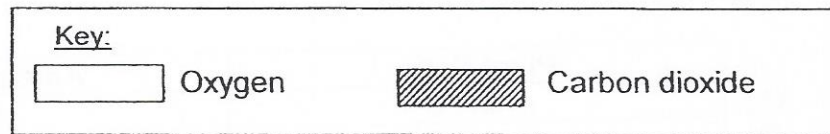

(1)

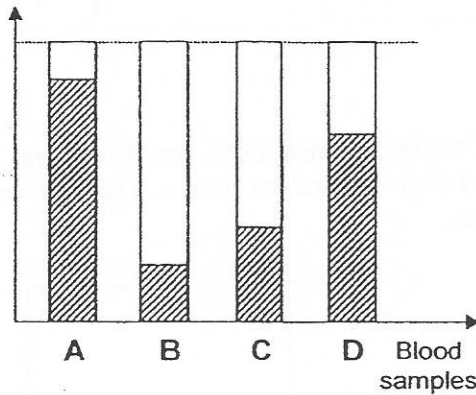

(3)

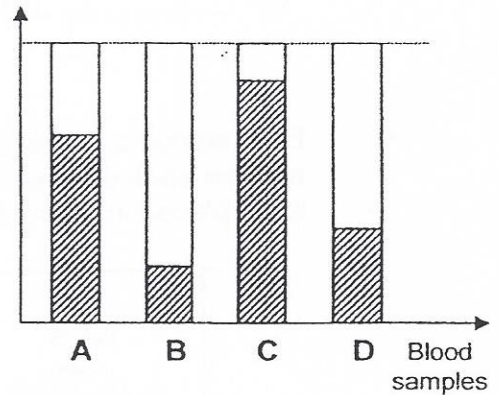

(2)

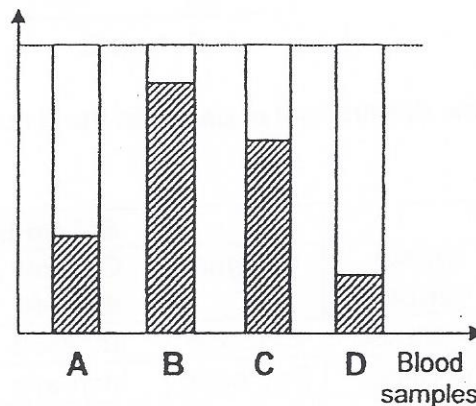

(4)

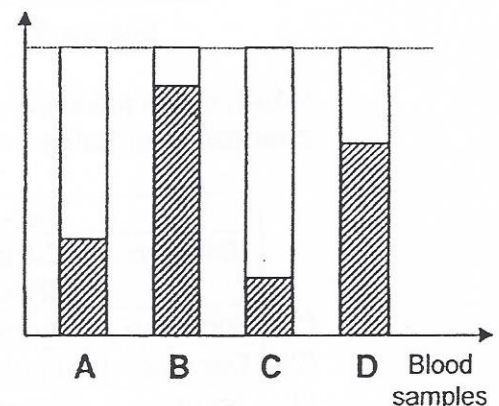

6. The diagrams below show the cross-section of a stem and part of a human blood vessel.

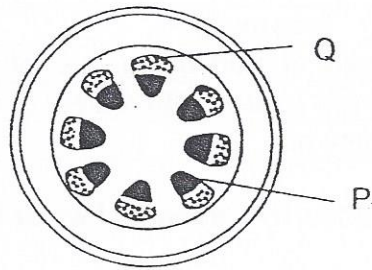

cross-section of stem

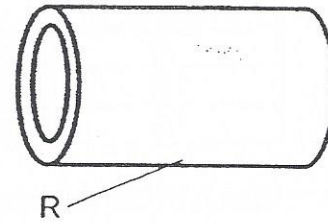

part of a human blood vessel

Which of the following correctly shows the functions of parts P, Q and R?

	P	Q	R
(1)	Transport food	Transport water	Transport food
(2)	Gaseous exchange	Transport food and water	Gaseous exchange
(3)	Transport water	Transport food	Transport water and food
(4)	Transport water and food	Gaseous exchange	Transport food

7. Jane conducted the experiment as shown below.

She got water from 3 different sources. X, Y and Z which was in Beakers A, B and C respectively.

She placed 2 similar water plants and 3 similar guppies into each of the beaker. All 3 beakers were kept near an open window and she fed the guppies with the same amount of food every day.

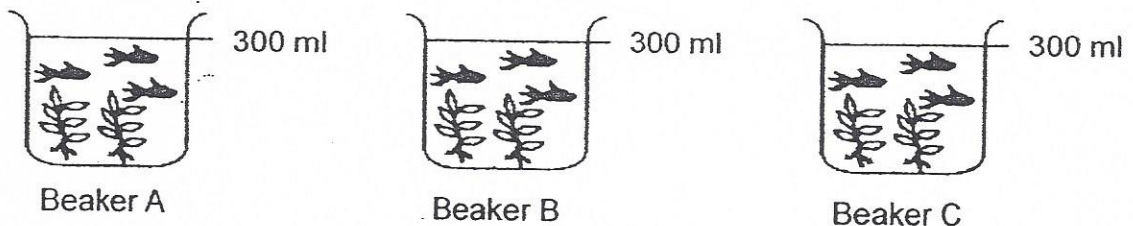

What is the aim of Jane's experiment?

- (1) To find out if light affects the growth of plants.
- (2) To find out if type of water affects the growth of guppies.
- (3) To find out if placing guppies with plants affect growth of the plants.
- (4) To find out if feeding guppies increases rate of reproduction.

8. Kayla carried out an experiment to investigate the loss of water from 3 similar leafy plants placed in the same room. The leaves of the plants were treated as follows:

Plant	Treatment
A	Upper leaf surfaces were coated with a layer of oil.
B	Lower leaf surfaces were coated with a layer of oil.
C	Leaf not coated with any oil

Which of the following graphs correctly show the amount of water loss from the 3 plants?

(1)

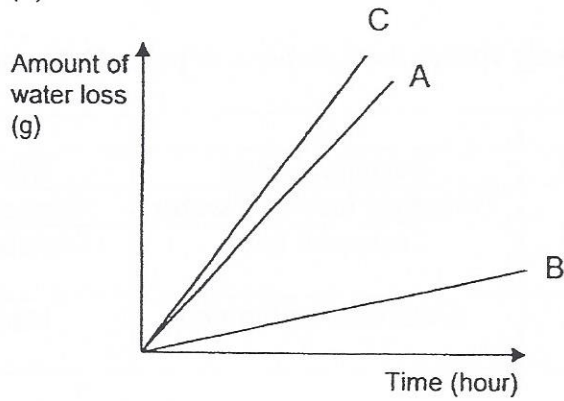

(3)

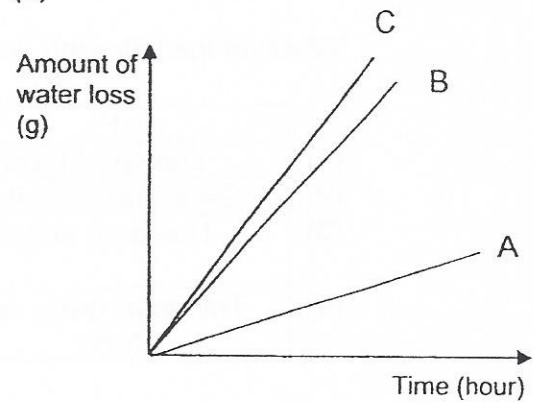

(2)

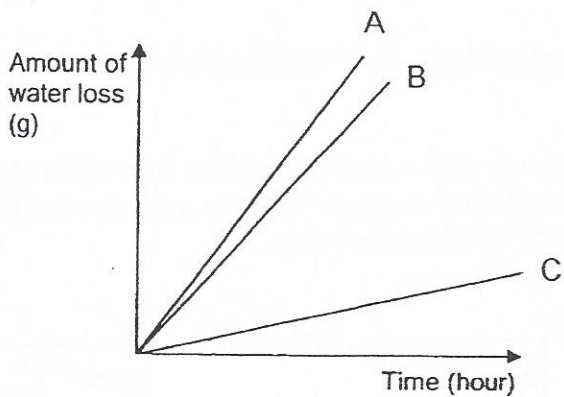

(4)

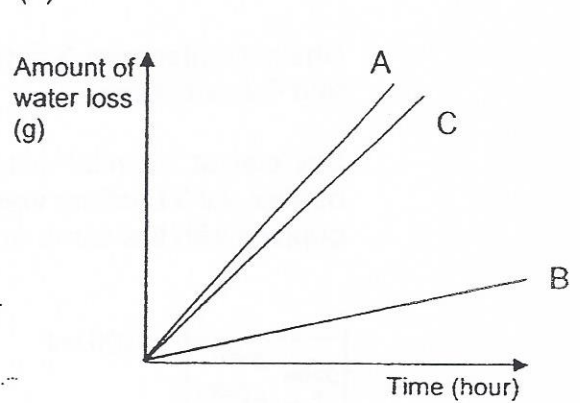

9. Jane studied the growth of Fern X on the trunks of trees under various habitat conditions. She recorded her findings as shown.

Conditions	Shady and dry	Bright and dry	Bright and moist	Shady and moist	Dark and moist
Area of trunk covered by Fern X (cm ²)	11	5	13	20	0

Which of the following conclusions can be drawn from her results?

- (1) Fern X has twining stems.
- (2) Fern X cannot grow well in polluted environments.
- (3) Fern X grows better in dry places than in moist places.
- (4) Fern X grows better in shady places than in bright places.

10. Which of the following are true of food chains and food webs?

- A: A food chain can only end with an omnivore.
- B: Food chains always begin with a plant.
- C: All carnivores get their energy indirectly from plants.
- D: Omnivores get their energy only from herbivores or carnivores.

- (1) A and D only
- (2) B and C only
- (3) A, B and C only
- (4) A, B, C and D only

11. Stacey conducted an experiment to find out the conditions required for the germination of seeds. She used 4 similar seeds A, B, C and D, in her experiment. The table below shows the physical conditions that were provided for each of the seeds.

Seed	Physical Conditions			
	Air	Water	Light	Temperature (°C)
A	Absent	Present	Present	50
B	Present	Absent	Present	0
C	Present	Present	Absent	32
D	Absent	Present	Absent	25

Which of the following seeds germinated?

- (1) A
- (2) B
- (3) C
- (4) D

12. The animal below lives in one of the biggest deserts in the world where water is scarce and where there are no plants shading it from the harsh sunlight.

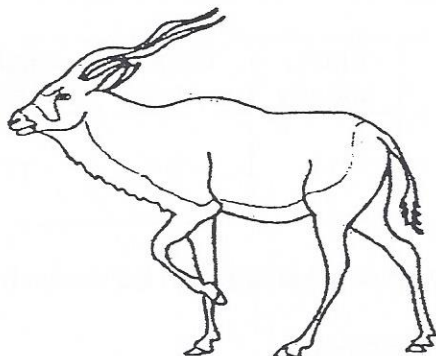

Are the features of the animal stated below "behavioural" or "structural" adaptations?

	Not needing to drink water for long periods	Changing colour of coat from white in Summer to brown in Winter
(1)	Behavioural	Structural
(2)	Structural	Structural
(3)	Structural	Behavioural
(4)	Behavioural	Behavioural

13. The following diagrams show the flower and seed of a new species of plant recently discovered by a group of scientists. The diagrams are not drawn to scale.

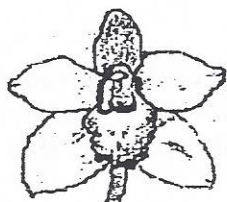

A flower from the plant



A seed from the plant

They analysed the structure of the flower, fruit and seed and found the following:

- The fruit is juicy and sweet.
- There are many small and hard seeds in each fruit.
- The flowers are small, colourful and grow in bunches.
- The flowers have sticky pollen grains.

Based on the information given above, what is the most likely way the seeds are dispersed?

- (1) wind
 (2) water
 (3) splitting
 (4) animals

14. Hannah has 2 adult pet cats with different characteristics as shown below.



Male
Black fur
Blue eyes
Short tail

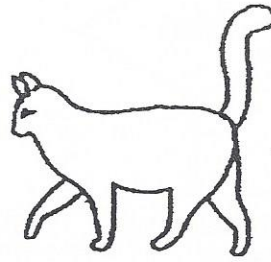

Female
White fur
Green eyes
Long tail

The female cat gave birth to only 3 kittens.

Which of the 4 kittens below is most likely not an offspring of Hannah's adult cats?

(1)



Kitten A
Female
Black fur with white spots
Green eyes
Long tail

(3)

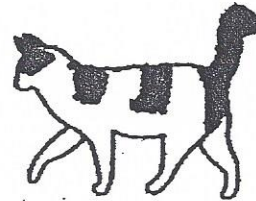

Kitten C
Male
White fur with brown stripes
Blue eyes
Short tail

(2)

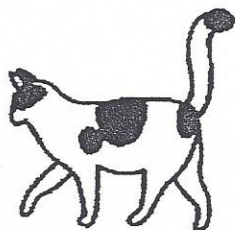

Kitten B
Female
White fur with black spots
Green eyes
Long tail

(4)

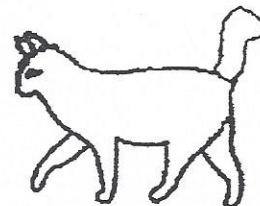

Kitten D
Male
White fur
Blue eyes
Short tail

15. Study the flowchart below.

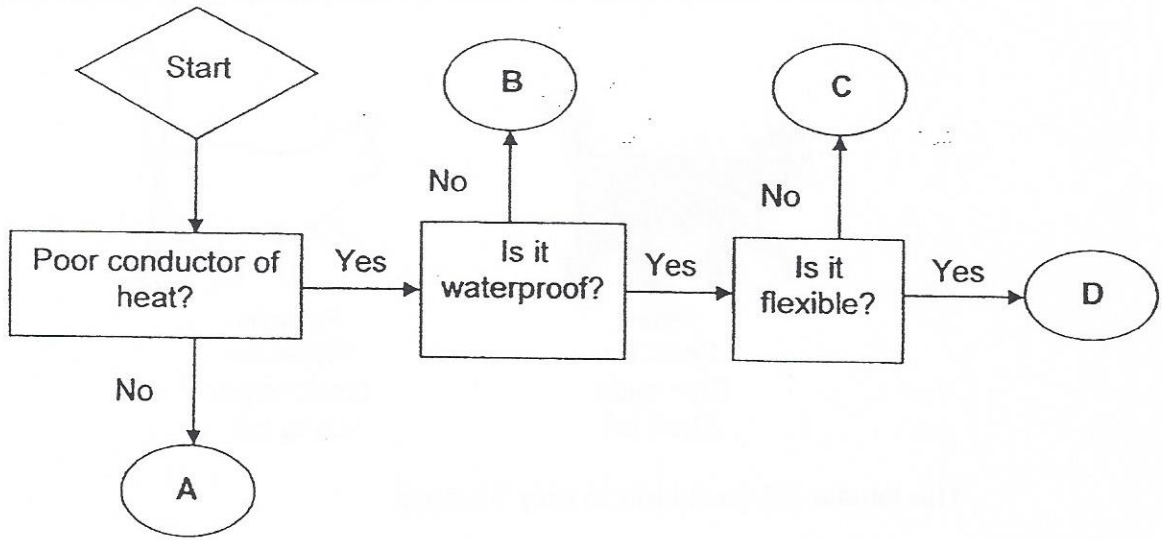

Which of the above is suitable for making parts X and Y of the cooking pot below?

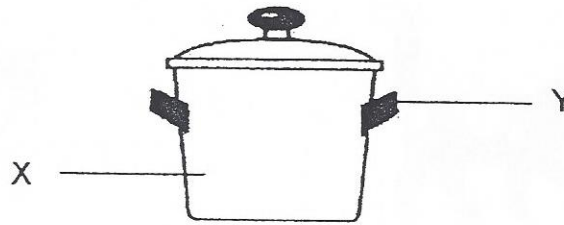

	X	Y
(1)	A	D
(2)	A	C
(3)	D	C
(4)	D	B

16. Study Organism X and the classification chart below.

Organism X



Based on the classification chart, which description (1), (2), (3) or (4) does Organism X belong to?

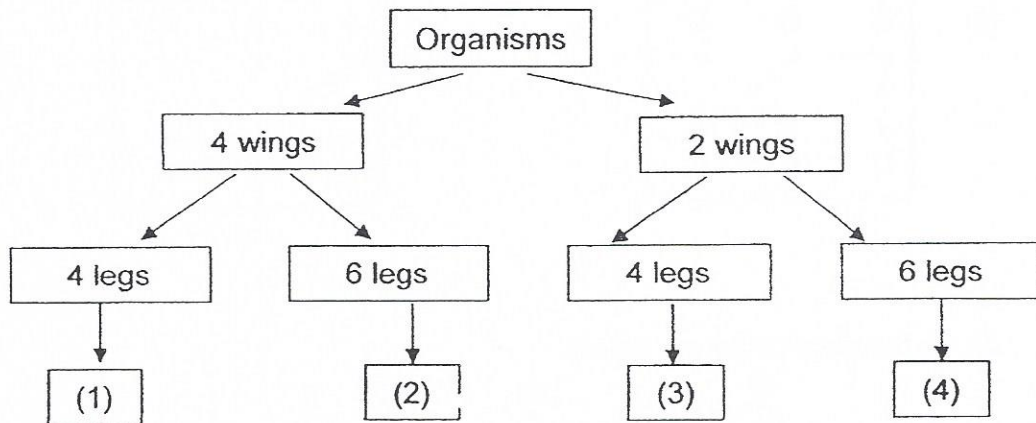

17. Gabrielle used a circuit tester to test different points of a circuit card. Her results are shown in the table below.

Points	Does the bulb light up?
AB	Yes
BC	No
CD	No
DE	No
EF	Yes
AF	Yes
BD	No

Which of the following circuit cards did she use to get the above results?

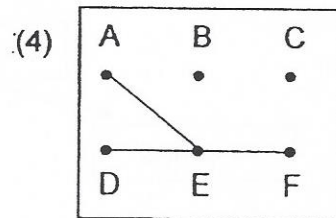
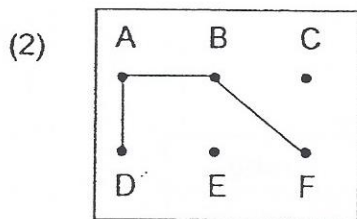
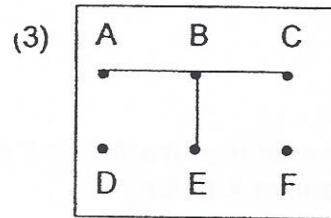
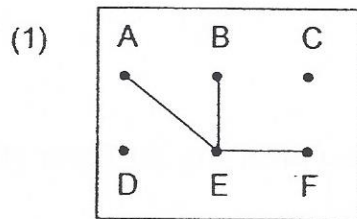

18. Study the circuit diagram below.

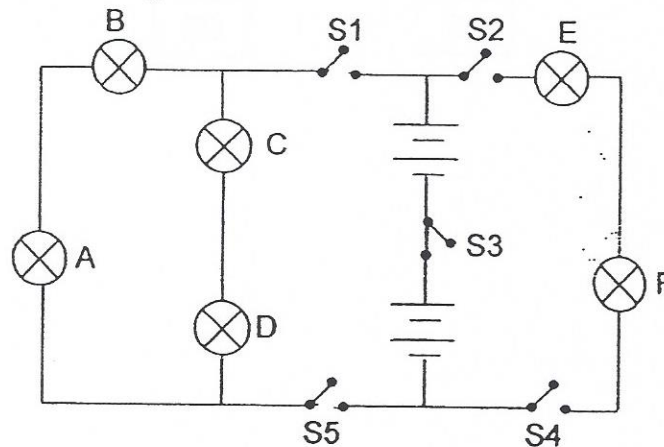

Which of the following switches must be closed so that only 4 bulbs will light up?

- (1) S1, S3 and S5
 (2) S2, S3 and S4
 (3) S1, S2, S4 and S5
 (4) S1, S2, S3, S4 and S5

19. Samantha set up the circuit below and connected different objects to the circuit at testing positions P, Q and R. She recorded her findings in the table below.

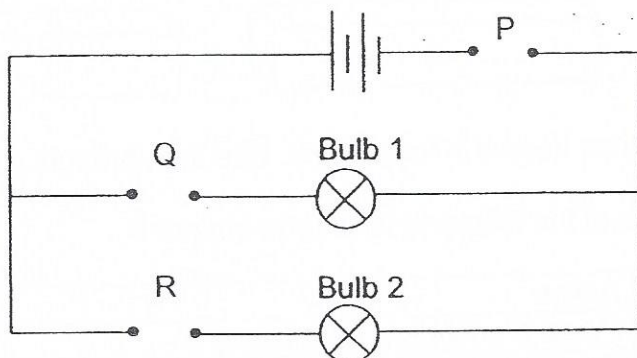

Objects placed at			Does the bulb light up?	
P	Q	R	Bulb 1	Bulb 2
A	B	C		
B	A	D		✓
C	D	A	✓	
A	B	D		

Which of the following object/s are conductors of electricity?

- (1) A and D only
 (2) C and D only
 (3) B, C and D only
 (4) A, B, C and D

20. The table below shows the properties of 4 substances, P, Q, R and S.

Substance	Is it magnetic?	Can it float on water?
P	No	No
Q	Yes	No
R	No	No
S	Yes	Yes

The substances are mixed together in a beaker and the following shows the steps Amanda took to separate the substances.

- Step 1: Pour some water into the beaker.
 Step 2: Use a spoon as a scoop.
 Step 3: Place a magnet close to the mixture.

Which of the substances can be separated from the rest after Amanda has carried out the steps in the sequence above?

- (1) Q only
 (2) Q and S only
 (3) P and S only
 (4) None of the above

21. Shannon placed 2 magnets as shown below.
When the 2 magnets were brought together, they attracted each other.

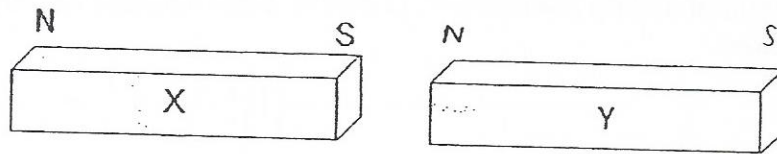

She then heated Y for an hour. She then brought X near Y.

Which of the following is likely to happen?

Action	Result
(1) When X's North pole is facing Y	Will repel
(2) When X's South pole is facing Y	Will neither attract or repel
(3) When X's North pole is facing Y	Will neither attract or repel
(4) When X's South pole is facing Y	Will attract

22. The following table shows the freezing and boiling points of 3 unknown substances, R, S and T.

Substance	Freezing Point ($^{\circ}\text{C}$)	Boiling Point ($^{\circ}\text{C}$)
R	30	85
S	22	115
T	18	70

Which of the following correctly shows the states of R, S and T at 110°C ?

	R	S	T
(1)	solid	gas	liquid
(2)	gas	liquid	gas
(3)	solid	liquid	solid
(4)	gas	gas	gas

23. The experiment shown below is conducted with 4 different magnets, P, Q, R and S.
Distance E is the greatest distance between the magnet and the iron nails for attraction to take place.

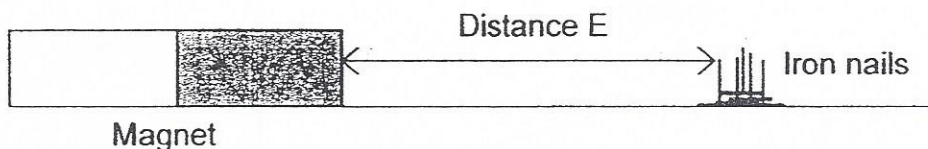

The magnets are ranked according to their strength as shown below.

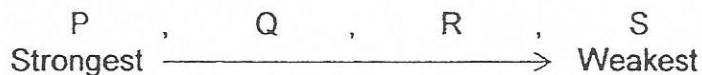

The table below shows the results of the experiment.

Magnet	Distance E (mm)	Number of iron nails that moved towards the magnet
P	40	3
Q	X	3
R	25	3
S	Y	3

Which of the following are possible distances X and Y for magnets Q and S listed in the table above?

	X (mm)	Y (mm)
(1)	30	15
(2)	45	20
(3)	15	10
(4)	20	30

24. Hannah conducted an experiment using 4 ramps of different height and different material. She placed the same 2-kg wooden block on the top of the 4 ramps and pushed it down with the same amount of force.

On which of the following ramps will the wooden block move the furthest?

(1)

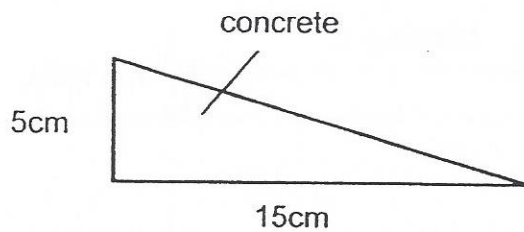

(3)

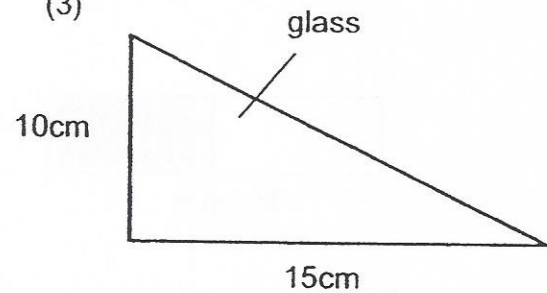

(2)

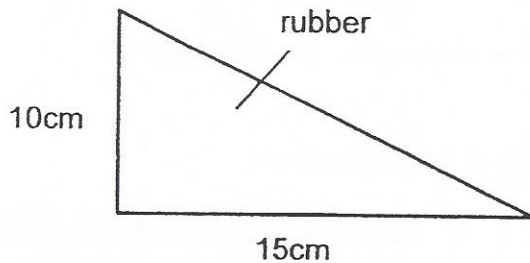

(4)

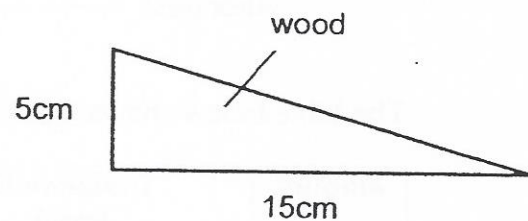

25. The diagram below shows a block of concrete with a hole in it.

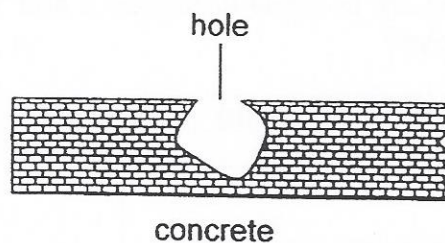

Jemma wants to measure the volume of the hole in the concrete block. Which of the following best shows the apparatus she should use in order to do so?

- (1) balloon, measuring tape
- (2) marbles, weighing scale
- (3) water, measuring cylinder
- (4) measuring tape, calculator

26. Farah set up an experiment as shown in the diagram below.

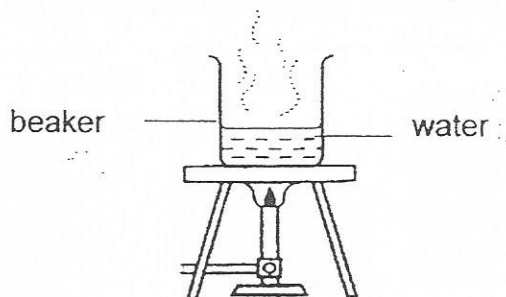

The mass of the beaker was 100g. She added 100g of water at 25°C and started heating.

After every 10 minutes, she lifted the beaker and weighed it. She then quickly returned the beaker to the flame to continue heating till the 70th minute.

which of the following tables correctly shows the total mass of the water and the beaker throughout the experiment?

(1)

Time (min)	Total mass (g)
0	200
10	195
20	178
30	155
40	136
50	116
60	108
70	94

(3)

Time (min)	Total mass (g)
0	200
10	200
20	200
30	177
40	135
50	114
60	100
70	94

(2)

Time (min)	Total mass (g)
0	100
10	92
20	75
30	57
40	36
50	18
60	0
70	0

(4)

Time (min)	Total mass (g)
0	200
10	195
20	183
30	156
40	134
50	117
60	100
70	100

27. Danielle wants to investigate the effect of exposed surface area on the rate of evaporation. Which of the set-ups is the best for her experiment?

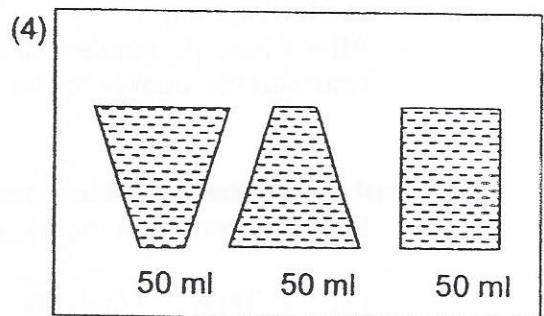
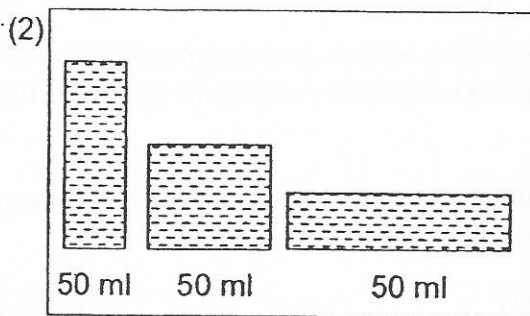
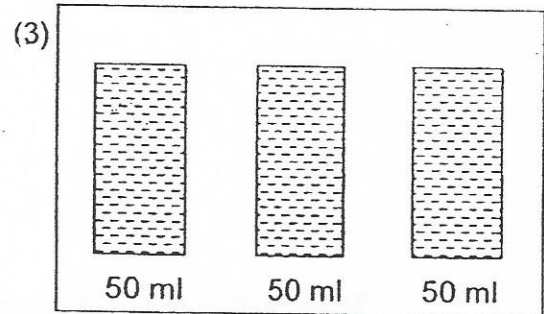
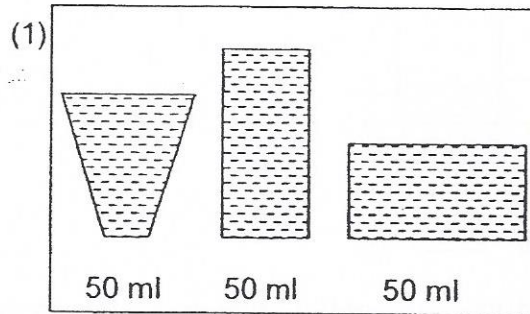

28. Alaina has 3 iron balls, F, G and H of different sizes and temperatures as shown in the table below.

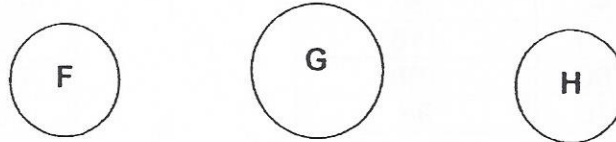

Ball	Volume	Temperature
F	40 cm ³	45 °C
G	80 cm ³	45 °C
H	40 cm ³	80 °C

The 3 balls are left on the same table to cool.

Which of the following statements is/are correct?

- A: Ball F has the least heat.
 B: Ball G will take a longer time than Ball F to cool to 30°C.
 C: Balls F and G will take the same amount of time to cool to 30°C.
 D: Ball H will take a longer time than Ball F to cool to 30°C.

- (1) A only
 (2) B only

- (3) A and C only
 (4) A, B and D only

29. The diagram below shows a hydroelectric power station.

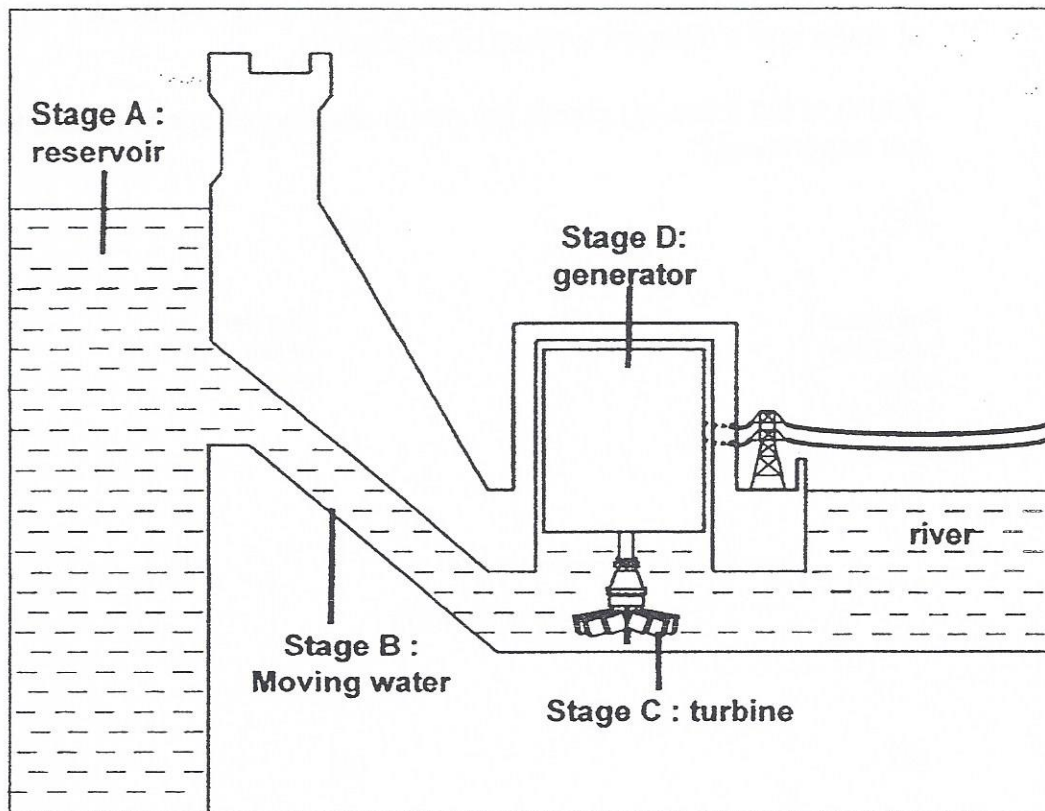

Below shows the energy conversions that may take place in some of the stages in the hydroelectric power station.

S: Kinetic Energy → Electrical Energy

T: Gravitational Potential Energy → Kinetic Energy

Which of the following matches the correct energy conversion with the correct stage at the power station?

	S	T
(1)	Stage D	Stage B
(2)	Stage C	Stage A
(3)	Stage C	Stage B
(4)	Stage D	Stage C

30. Melissa wanted to find out the effects of varying amounts of insecticide on aquatic organisms in a river.

She conducted an experiment with 4 set-ups. Each set-up has 25 fish, 500 ml of water and a different amount of insecticide.

Which of the following shows the graph she should use to record the results of her experiment?

(1)

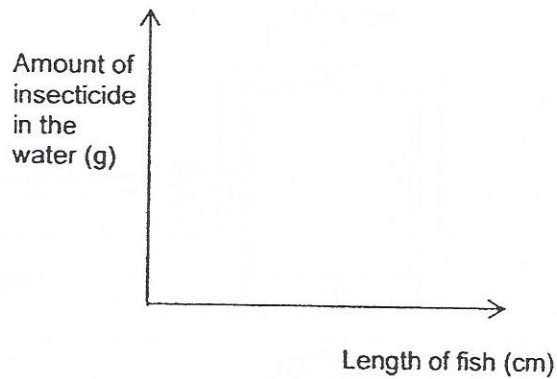

(3)

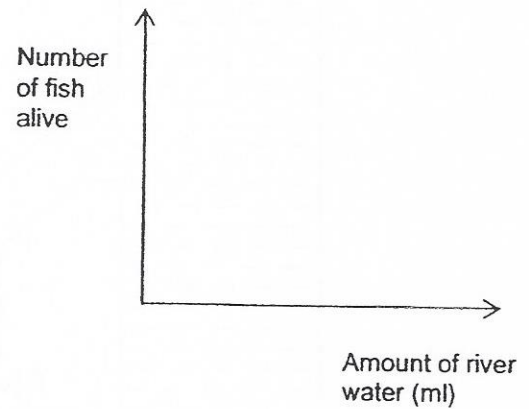

(2)

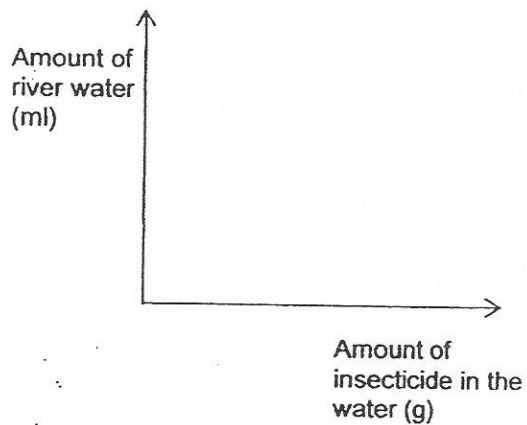

(4)

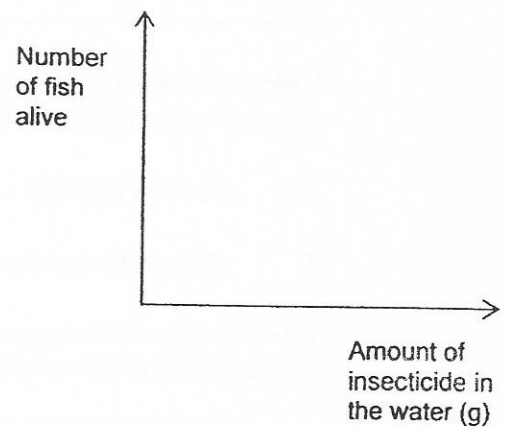

SINGAPORE CHINESE GIRLS' SCHOOL (PRIMARY)

PRIMARY SIX PRELIMINARY ASSESSMENT 2015

NAME: _____ ()

DATE: _____

CLASS: PRIMARY

Parent's Signature: _____

SCIENCE

BOOKLET B

	Total Actual Marks	Total Possible Marks
Booklet A		60
Booklet B		40
Total		100

14 questions

40 marks

Total time for Booklets A & B: 1 h 45 min

DO NOT OPEN THIS BOOKLET UNTIL YOU ARE TOLD TO DO SO.

FOLLOW ALL INSTRUCTIONS CAREFULLY.

Part II (40 marks)

Answer all the following questions.

31. Bernadette sets up an experiment to find out which material, P, Q, R or S, is most suitable for making a rain coat.

She pours water onto 4 sheets made of materials P, Q, R and S, that are secured at the rim of the beakers. The amount of water collected in each beaker and/or on each material is shown below.

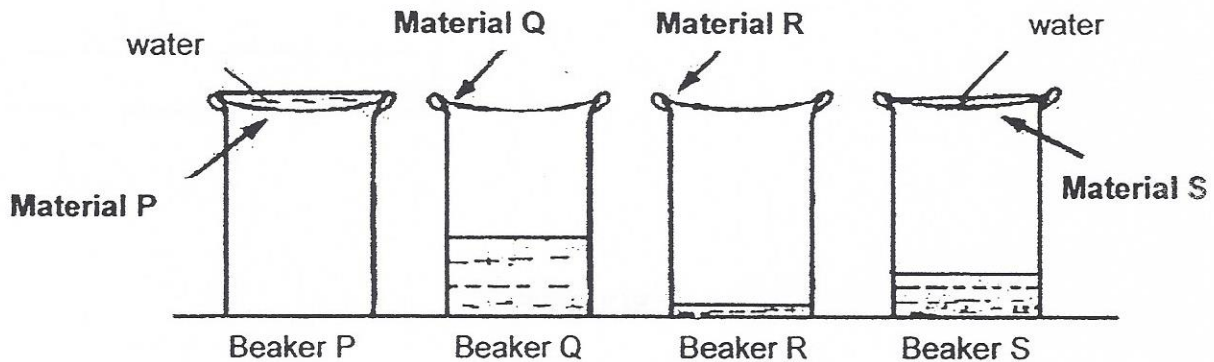

- a) State the variable that must be kept constant in Bernadette's experiment. (1m)

- b) Bernadette concluded that Material R is most suitable for making a raincoat. Her friend, Lilian disagrees.

Explain why Lilian is correct.

(1m)

- c) State which material is most suitable for making a raincoat and explain your choice. (1m)

32. Patricia carried out an experiment as shown in the diagram below.

She attached a bag made of Material M to a glass tube and filled it with starch solution. She immersed the bag and glass tube into a trough of pure water.

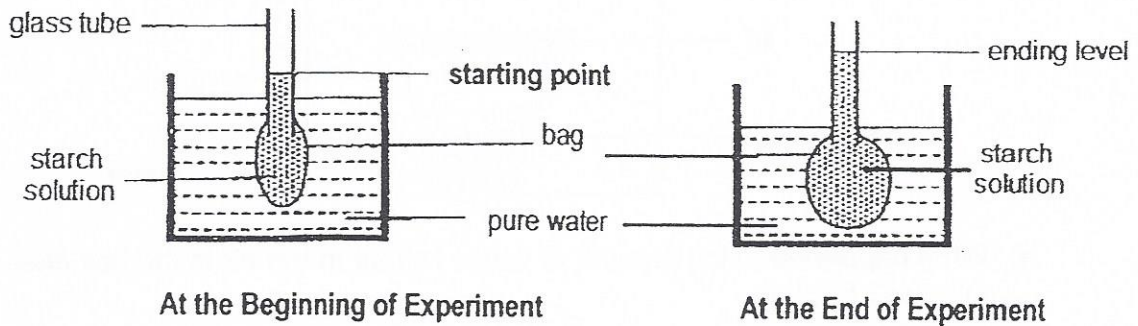

At the end of the experiment, Patricia noted the changes in the size of the bag and the water levels in the glass tube and the trough.

a) Tick (✓) the following conclusion/s she can make about Material M. (1m)

	Statement	(✓)
i)	Material M allows pure water to pass through.	
ii)	Material M allows starch solution to pass through.	
iii)	Material M does not allow pure water to pass through.	
iv)	Material M does not allow starch solution to pass through.	

b) Which part of a cell is similar in function to the bag in the above experiment? (1m)

33. Catherine placed a glass of cold water and ice cubes in a sealed transparent box as shown in the diagram below. She then waited for 10 minutes.

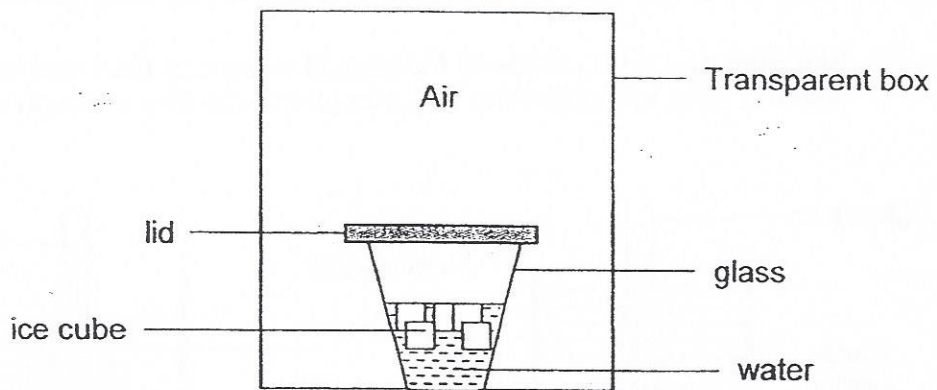

- a) What happened to the amount of water vapour in the air in the box after 10 minutes? Explain. (2m)

Catherine then placed a hot glass of water in a similar sealed transparent box.

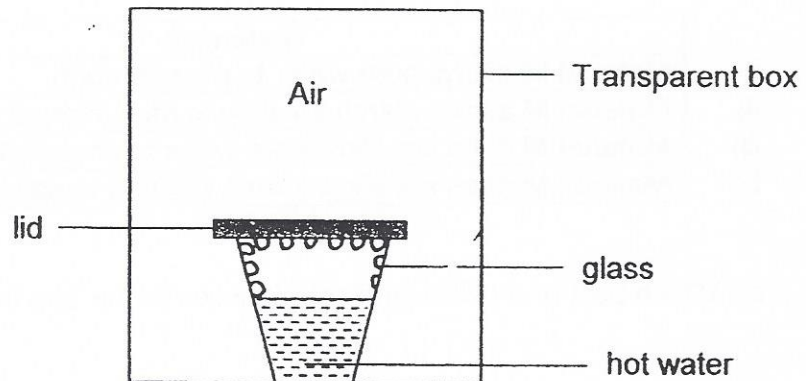

- b) What happened to the amount of water vapour in the air in the box after 10 minutes? (1m)

- c) In the diagram with the hot water above, draw where the water droplets will be formed (1m)

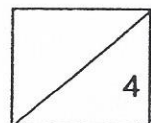

34. Melanie heated 6 similar pieces of wax in 6 curved dishes A, B, C, D, E and F, made of different materials. She heated each piece of wax for 5 minutes.

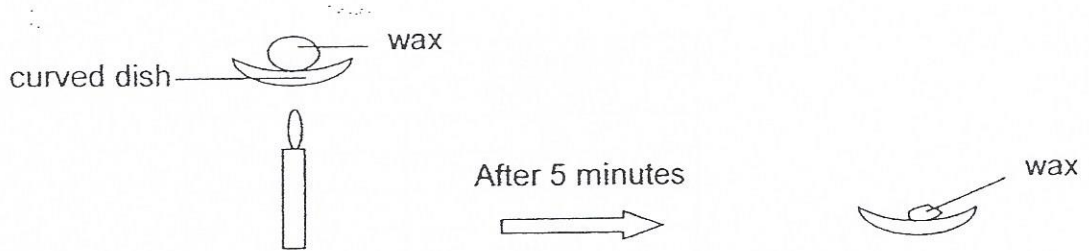

She quickly separated the solid wax from the liquid wax and measured the mass of solid wax left. Her results are plotted in the graph as shown below.

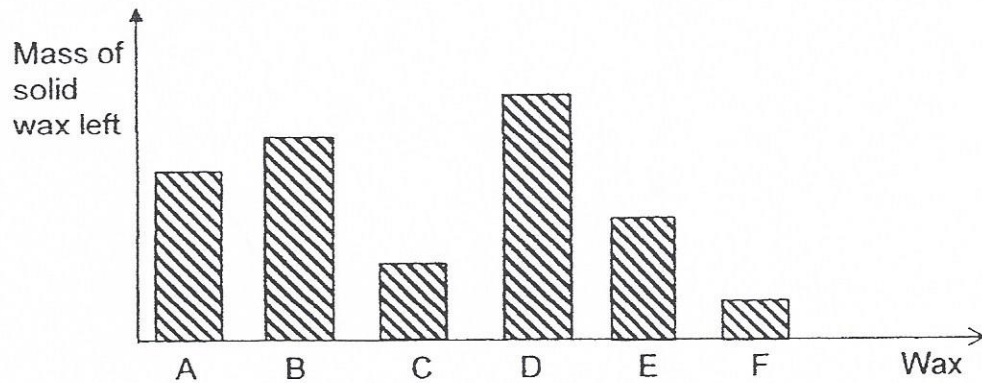

Based on the results of her experiment, put a tick () in the correct box to indicate whether each statement is True or False. (2m)

	Statement	True	False
(i)	Material C is a better conductor of heat than material A.		
(ii)	Material A is a better conductor of heat than material E.		
(iii)	Material B is a poorer conductor of heat than material F.		
(iv)	Material D is the best conductor of heat among all the materials.		

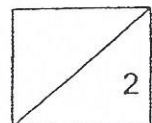

35. The food web below is incomplete.

- a) Based on the information given in the table below, draw four more arrows to complete the food web. (2m)

Organism	Diet
C, E, F, D	A
G	E
G, E, D	C
G	D
C, A	B

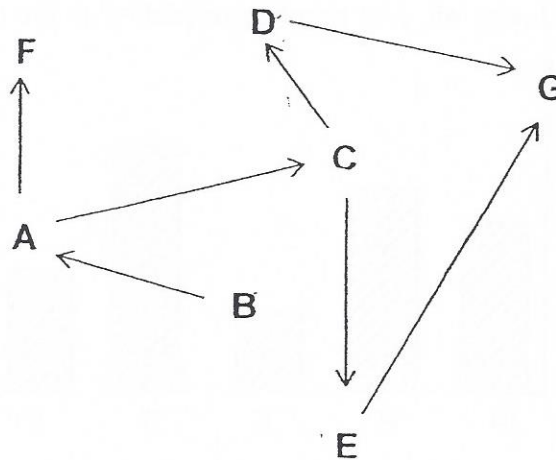

- b) State the food producer(s) in the above food web. (1m)

- c) Which organism has the greatest number of food sources? (1m)

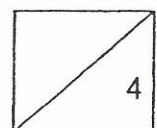

36. Audrey set up the experiment as shown in the diagram below. The masses of Magnet A and Object B are 85g and 140g respectively. Magnet X is fixed to the table.

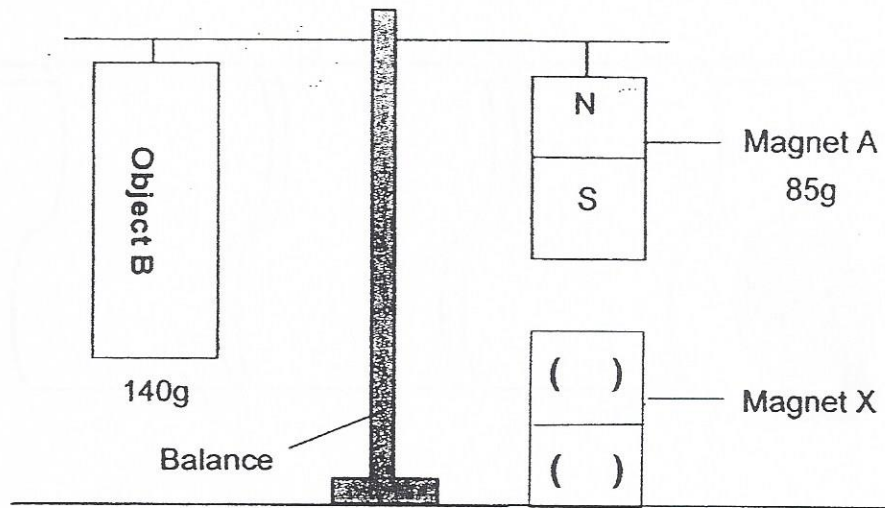

- a) In the diagram above, fill in "N" or "S" to show the poles of Magnet X. (1m)
- b) Explain how Object B is balanced by Magnet A. (1m)

- c) Object B is replaced by a similar-sized object C with a mass of 70g.

To balance Object C shown below, fill in "N" or "S" to show the poles of Magnet X in the brackets provided. (1m)

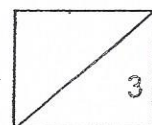
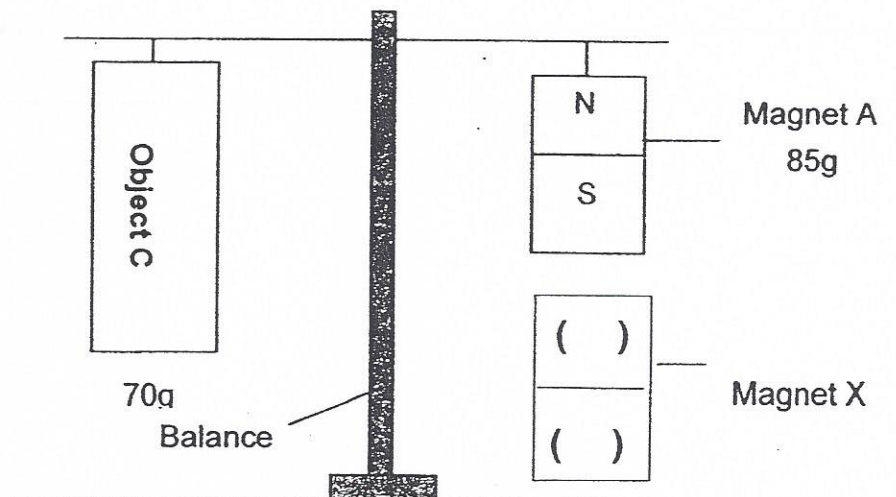

37. It was very hot and Mr Lin did not have air-conditioners in his room. To cool his room, Mr Lin decided to hang 3 big pieces of wet cloth and used 2 fans to cool his room as shown in the diagram below.

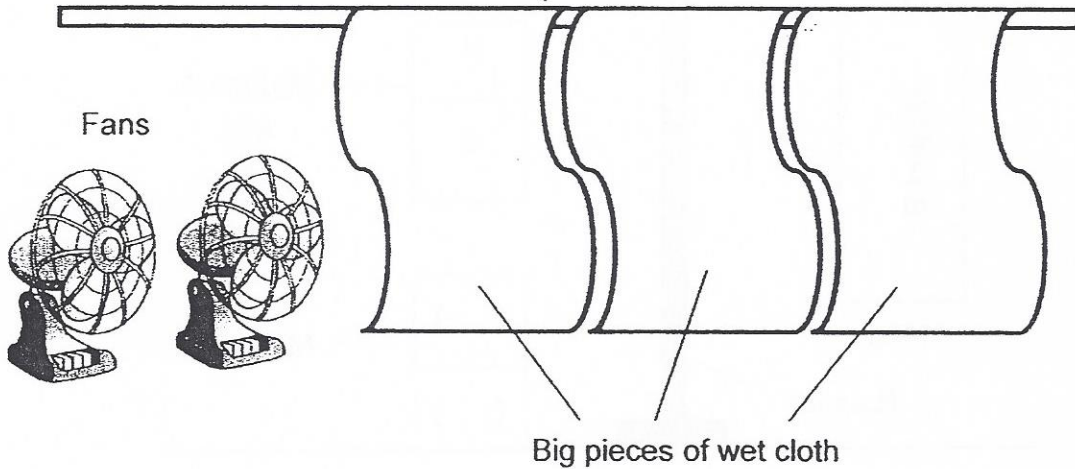

To test his set-up, he closed the windows and switched on the fans. Mr Lin found that the temperature in his room decreased by 2°C . Explain how each of the following allowed the temperature of the room to become lower. (2m)

Wet Cloth:

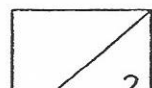

38. The diagram below shows the life cycles of Organisms A and B.

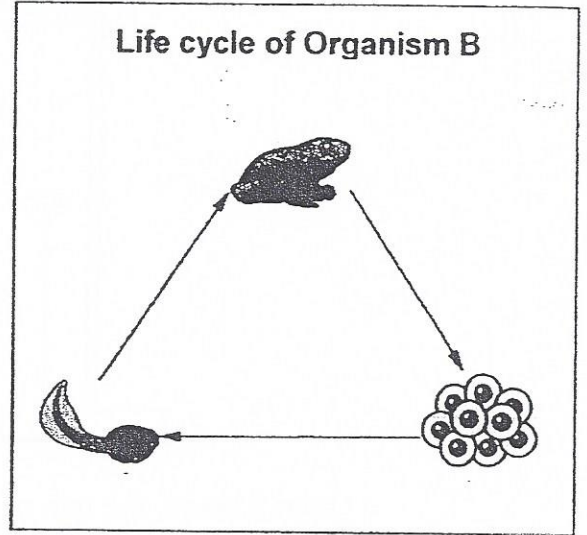
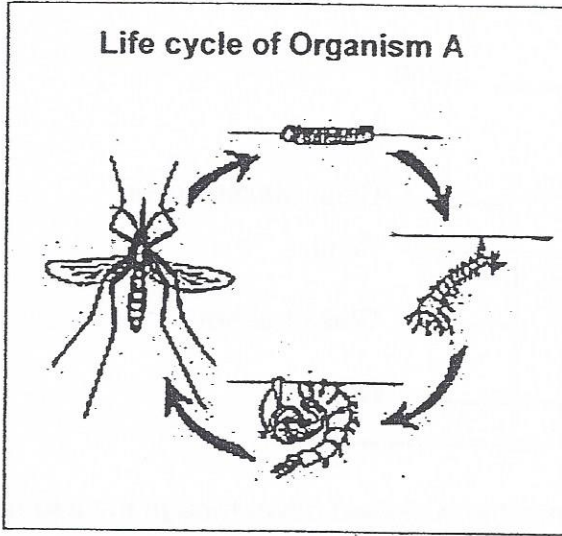

a) State 1 difference in the life cycles of the 2 organisms. (1m)

b) Both Organisms A and B lay eggs in water. State **another** similarity in the life cycles of the 2 organisms. (1m)

c) Study the chart below. Fill in "A" or "B" in the correct circle to show where the **adult** of Organisms A and B belong on the chart. (1m)

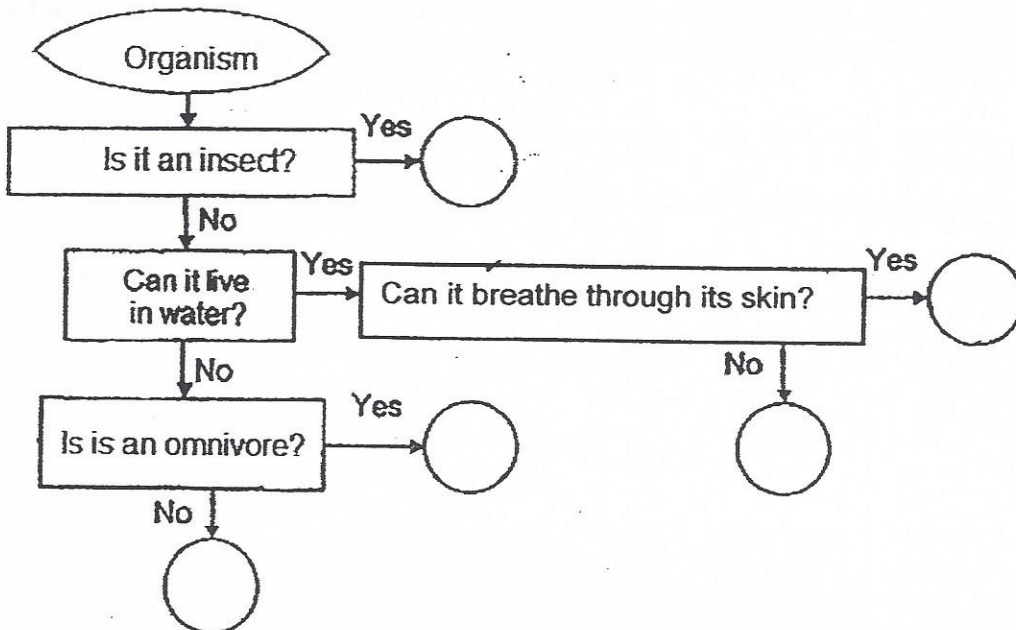

39. Susan set up the experiment as shown below and placed it inside a cupboard.

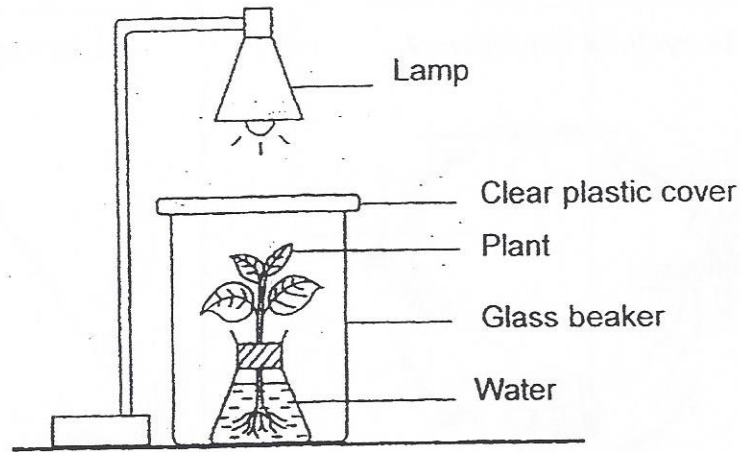

After 6 hours, the rate of photosynthesis slowed down though the intensity of light from the lamp remains the same.

a) State what caused the rate of photosynthesis to slow down. (1m)

b) Susan's friend said she should add something to her set-up to increase the rate of photosynthesis

She makes the following suggestions

- A: Adding one more lamp.
- B: Pouring more water to the flask.
- C: Placing a rat in the glass beaker.
- D: Putting fertilizers to the water in the flask.

Which one of the above suggestion, A, B, C or D, should Susan adopt to increase the rate of photosynthesis in her set-up? Explain. (2m)

40. The diagram below shows a gymnast swinging on a horizontal bar.

Position 1 shows her starting point, where she swings forward to Position 2 before swinging backwards and over the pole to Position 9 shows where she lands loudly with a thud.

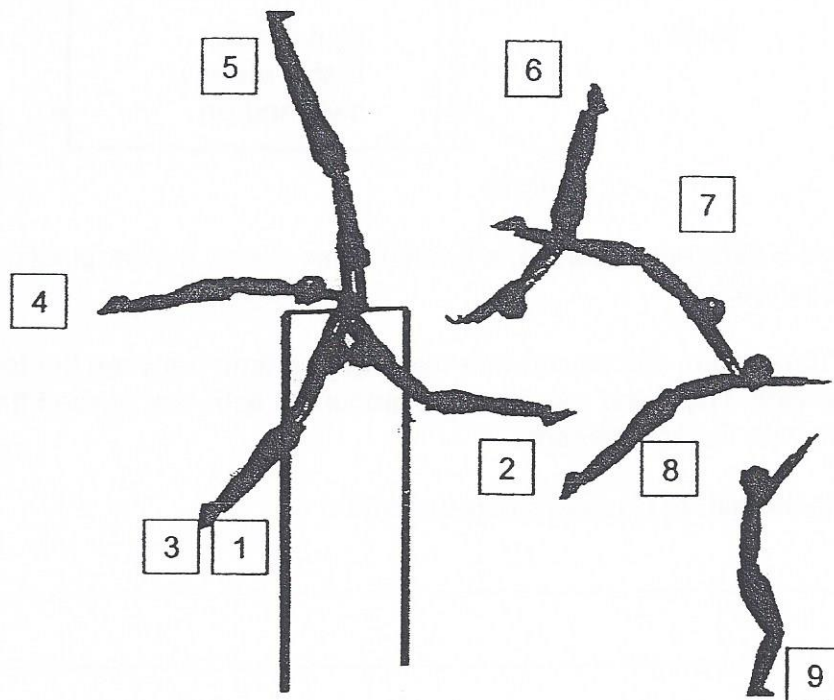

a) At which position does the gymnast possess the most gravitational potential energy? (1m)

b) Write the energy conversion from Position 8 to Position 9. (1m)

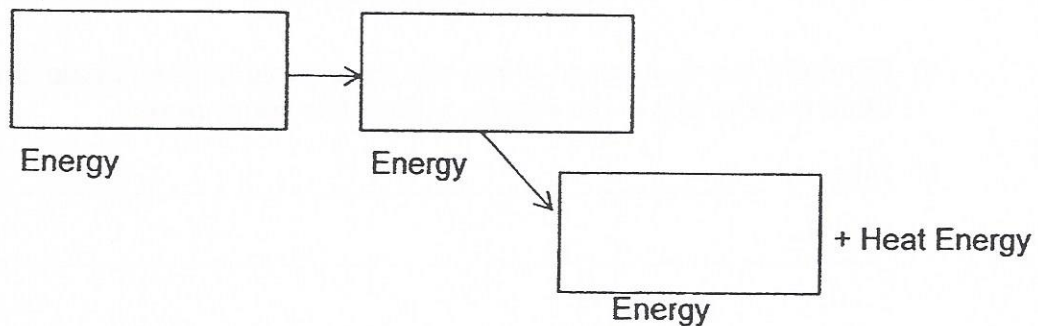

c) What is the source of the gymnast's energy? (1m)

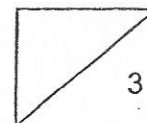

41. Hannah conducted an experiment in a dark room as shown in the diagram below.

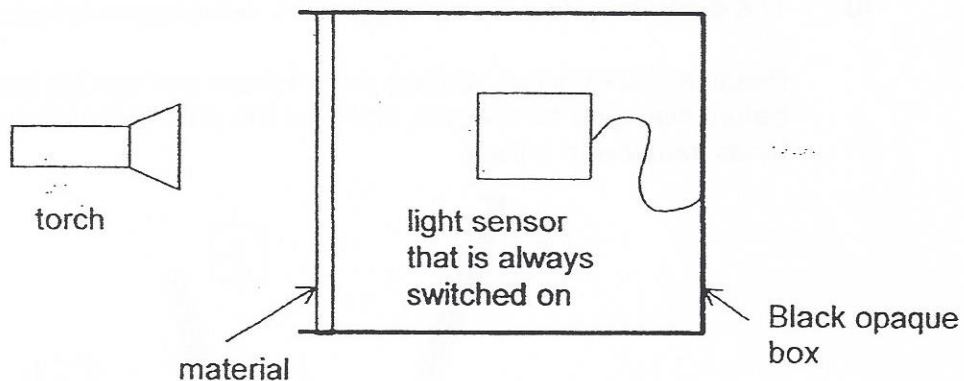

She had 3 different materials, a frosted glass sheet, a clear plastic sheet and a metal sheet.

In the dark room, she placed one material at a time between the torch and the light sensor. Then, she recorded the amount of light that passed through each of them with the light sensor.

- a) What is the aim of Hannah's experiment? (1m)

The graph below shows the results of Hannah's experiment.

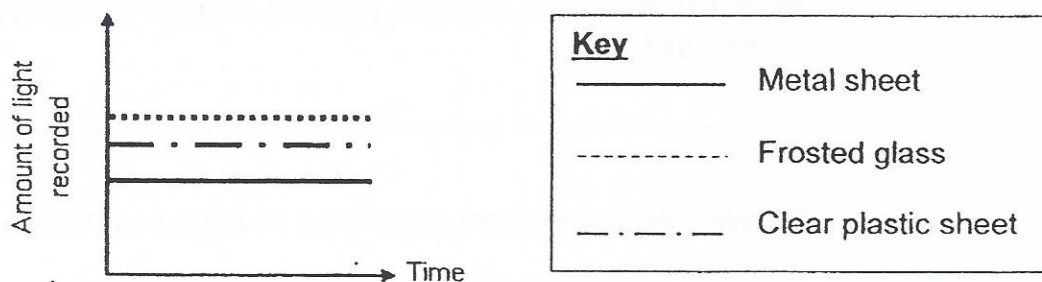

- b) Hannah's teacher looked at her results and told her she made 2 mistakes. State the 2 errors in her results and explain your answer. (2m)

i) Error 1: _____

ii) Error 2: _____

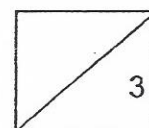

42. The picture below shows a great white shark which lives in oceans.

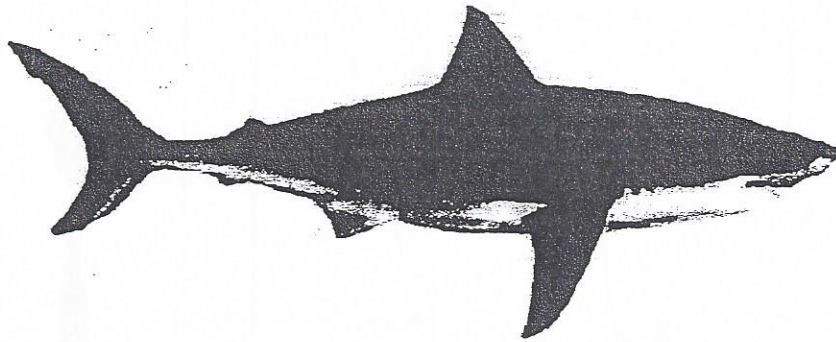

a) The great white shark is a fish that is usually the final consumer in the food chain.

The shark has a dark-coloured back and a white belly. State why these characteristics are beneficial to the shark in its habitat.

i) Dark-coloured back (1m)

ii) White belly

b) The shark, like most fish, is highly adapted for movement in water.

Explain how the shark's body shape helps it to move quickly in water. (1m)

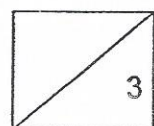

43. Gabrielle set up an incomplete circuit as shown below.

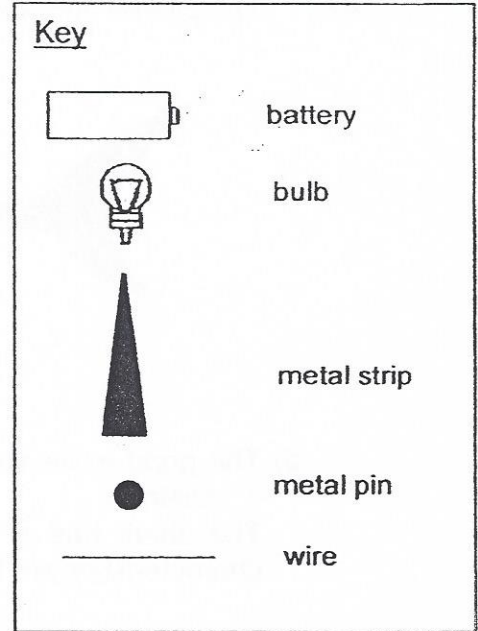
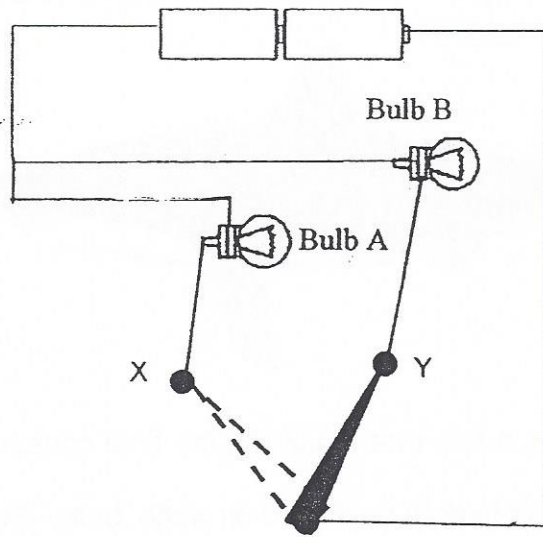

The metal strip can be moved to touch the pins X and Y to act as a switch.

a) Draw 3 wires in the circuit above so that only Bulb A will light up when the metal strip is at X and only Bulb B will light up when the metal strip is at Y. (2m)

b) What is the disadvantage of using such a circuit in a household? (1m)

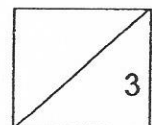

44a) The diagrams below show the reproductive systems of a flower and the human female reproductive system.

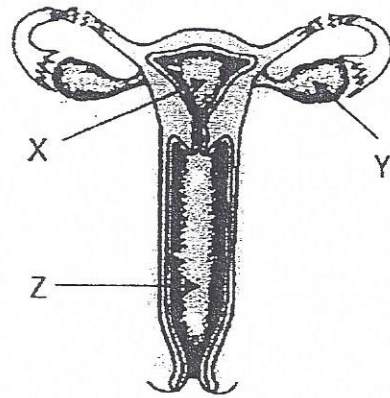
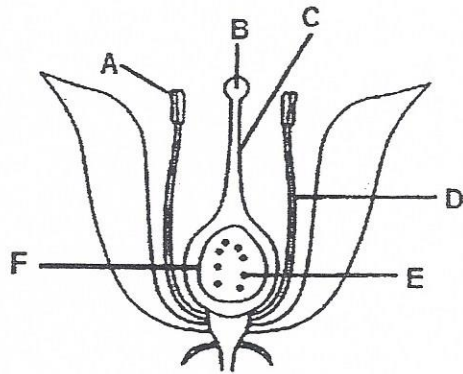

Reproductive system of flower

Human female reproductive system

Which parts of the 2 systems produce the female sex cells for fertilization?

i) In the flower : Part _____

(1m)

ii) In the female human: Part _____

44b) The diagram below shows a flower and 3 fruits, A, B and C.

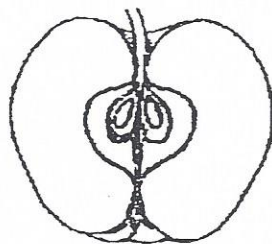
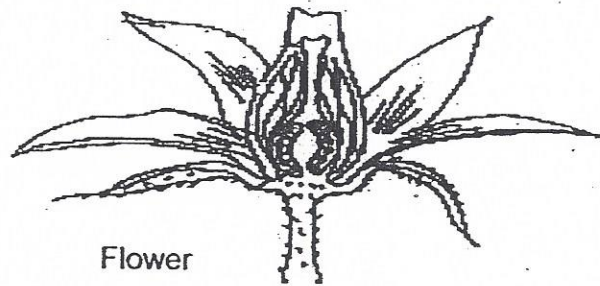

Fruit A

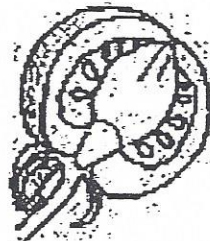

Fruit B

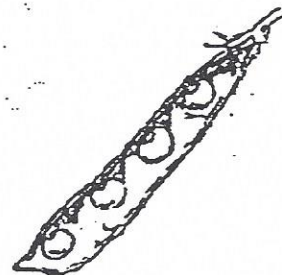

Fruit C

Which fruit, A, B or C, is most likely from the flower shown?

(1m)

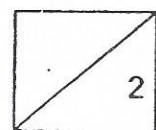

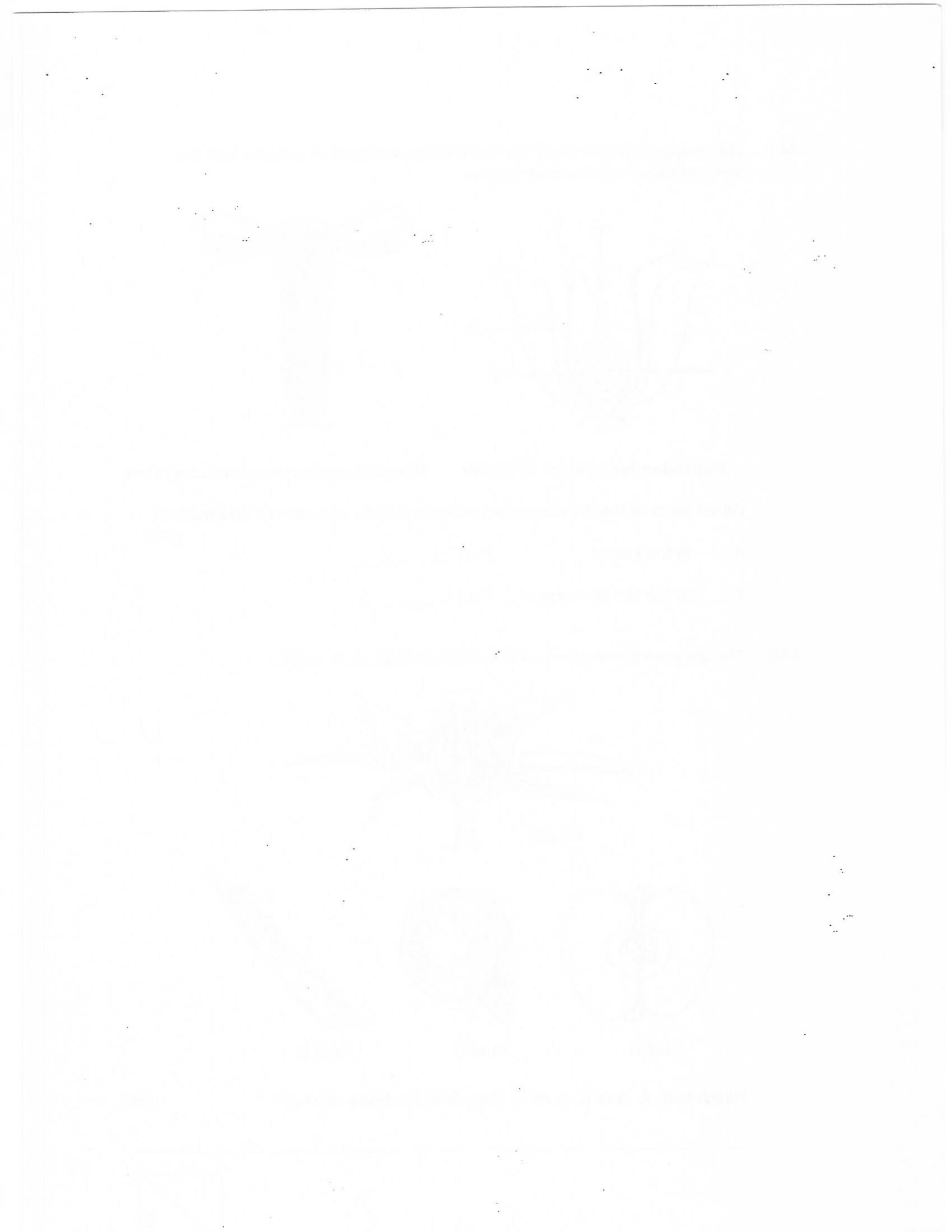

Booklet A									
1) 3	6) 3	11) 3	16) 2	21) 4	26) 4				
2) 2	7) 2	12) 2	17) 1	22) 2	27) 2				
3) 1	8) 1	13) 4	18) 1	23) 1	28) 4				
4) 4	9) 4	14) 3	19) 3	24) 3	29) 1				
5) 1	10) 2	15) 2	20) 2	25) 3	30) 4				

Booklet B
 Suggested Answers

31a.	Amount / Volume of water poured onto the materials OR Thickness of material	
31b	Size of material ----- ½ (not specific about the thickness, area does not affect results only thickness may)	
31c	R is not suitable as it allows some water to pass through.	
32a.	P. It is (the only) waterproof material / did not allow any water to pass through at all.	
	Statement	(✓)
	i) Material M allows pure water to pass through.	✓
	ii) Material M allows starch to pass through.	
	iii) Material M does not allow pure water to pass through.	
	iv) Material M does not allow starch to pass through.	✓
32b.	Cell membrane	
33a.	It decreases. (1/2m) The warmer water vapour (1/2m) loses heat and condenses (1/2m) into water droplets on the cooler outer surfaces of the glass.(1/2m).	
33b.	It remains the same.	
33c.		
34.	T, F, T, F	

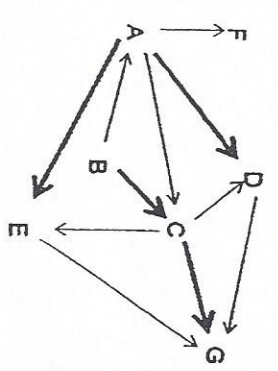
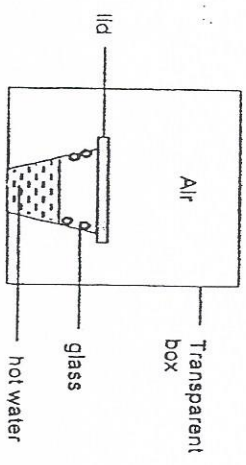

35a.	
35b.	B
35c.	G
36a.	N
36b.	As <u>Object B is heavier than Magnet A</u> , Magnet A needs to be pulled downwards (1/2) to balance. <u>Unlike poles attract</u> (1/2)so Magnet A is pulled downwards to balance Object B.
36c.	S
37.	Wet cloth (1 m) -Evaporation of water from the wet cloth gains heat from / removes / takes in heat from the surrounding air (1). Fan (1 m) – Wind increased the rate of evaporation/ speed up evaporation. (1)
38a.	A has 4 stages but B has 3 stages in their life cycles. OR: The young of A moults, the young of B does not moult.
38b.	The young does not resemble the adult. / Both the young do not look like the adult.
38c.	
39a.	The amount of carbon dioxide is being <u>depleted/ used up</u> by photosynthesis.

Name: _____
 Class: P6 _____

Reflection:

What are your major mistakes?

How do you plan to address them so that you reduce such mistakes in future?

39b	<p>Partial (1/2 m) Lack/ less and less of carbon dioxide in the glass beaker. (reason for partial – did not explain why there is a lack of carbon dioxide)</p> <p>'C' OR Placing a rat in the glass beaker. (1m) The rat will produce/ replenishes carbon dioxide (1/2) which the plant will take in/ requires/ needs for photosynthesis. (1/2)</p>
40a.	Position 5
40b.	PE -> KE -> SE (+ HE - given)
40c.	From the food she eats
41a.	To find out which material allows the most light to pass through/ blocks out the most light.
41b.	<p>Error 1: Clear plastic sheet is transparent while frosted glass is translucent. Therefore, more light should be able to pass through the clear plastic sheet than the frosted glass.</p> <p>Error 2: The styrofoam is opaque and light detected should be zero.</p>
42a.	<p>i) Dark-coloured back; Allows the shark to avoid being seen/ detected by prey from above (1/2) against the darker background of the sea (1/2)</p>
42b.	<p>ii) White belly : To avoid being seen / detected by prey from below (1/2) against the brighter background of the sky (1/2).</p>
43a.	<p>It has a streamlined body shape (1/2) to help to reduce/ cut down on water resistance (1/2) and move quickly in water.</p>
	
	<p>Check connection to the bulbs Check that it is a parallel arrangement for the circuit.</p>
	<p>Only one bulb can be switched on at a time. OR: Both bulbs <u>cannot</u> be switched on at the same time.</p>
	Flower : Part E, Female Human: Part Y (1/1)
B	