

NANYANG PRIMARY SCHOOL

SECOND SEMESTRAL EXAMINATION
2006

PRIMARY 3
MATHEMATICS

DURATION: 1 HOUR 45 MINUTES

Section A	/ 40
Section B	/ 40
Section C	/ 20

Total:	/ 100
--------	-------

Name: _____ ()

Class: Primary 3 ()

Date: 2 November 2006

Parent's Signature: _____

DO NOT OPEN THIS BOOKLET UNTIL YOU ARE TOLD TO DO SO.

FOLLOW ALL INSTRUCTIONS CAREFULLY.

ANSWER ALL QUESTIONS.

Section A

Questions 1 to 20 carry 2 marks each. For each question, four choices are given. One of them is the correct answer. Make your choice (1, 2, 3 or 4). Shade the oval (1, 2, 3 or 4) on the Optical Answer Sheet.

(Total: 40 marks)

1. How many tens are there in 9740?

(1) 974
(3) 40

(2) 74
(4) 4

2. Study the number pattern below.

3870 , 3830 , 3790 , ? , 3710

What is the missing number?

(1) 3740
(3) 3760

(2) 3750
(4) 3770

3. Julie sold a total of 3017 dolls during a 3-day carnival. If she sold 708 dolls on the first day and 1265 dolls on the second day, how many dolls did she sell on the third day?

(1) 944
(3) 1144

(2) 1044
(4) 1478

4. Samy had 433 marbles. He packed them equally into bags of 7. How many marbles were not packed in any bag?

(1) 60
(3) 3

(2) 61
(4) 6

5. $13 \times 8 = 152 - \boxed{?}$

What is the missing number in the box?

(1) 48

(2) 54

(3) 58

(4) 68

6. Grace has 294 sweets. If she gives the sweets equally to 6 friends, how many sweets does each of them get?

(1) 40
(3) 47

(2) 42
(4) 49

7. Tanaka bought a shirt that costs \$27.50 and a tie that costs \$26.50. He paid the cashier \$60.00. How much change would he receive?

(1) \$6.00
(3) \$16.00

(2) \$7.00
(4) \$54.00

8. What is 999 divided by 9?

- (1) 10
- (3) 100

- (2) 11
- (4) 111

9. If the clock below is 15 minutes faster, what is the actual time?

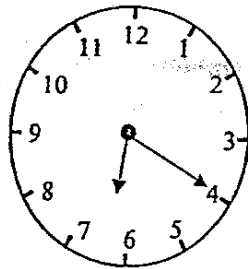

- (1) 4.15
- (3) 6.05

- (2) 4.30
- (4) 6.35

10. Muthu has 9 stickers. If Jenny gives away 4 stickers, she will have 7 times as many stickers as Muthu. How many stickers does Jenny have at first?

- (1) 35
- (3) 63

- (2) 59
- (4) 67

11. A jug had 345 ml of water in it. It was filled to the brim after pouring 1 l 705 ml of water in it. What was the capacity of the jug?

- (1) 1 l 360 ml
- (3) 13 l 60 ml

- (2) 2 l 50 ml
- (4) 20 l 50 ml

12. The total mass of a basket and a bunch of grapes is 1200 g. The mass of the basket is twice as ^{heavy} as the bunch of grapes. What is mass of the basket?

- (1) 200 g (2) 400 g
 (3) 600 g (4) 800 g

13. Which one of the following sets of fractions is arranged from the smallest to the greatest?

- (1) $\frac{1}{4}, \frac{1}{6}, \frac{1}{7}$ (2) $\frac{1}{6}, \frac{1}{4}, \frac{1}{7}$
 (3) $\frac{1}{7}, \frac{1}{6}, \frac{1}{4}$ (4) $\frac{1}{6}, \frac{1}{7}, \frac{1}{4}$

14. Jumari cycled from his house to the city passing through a park. How far did he travel in all?

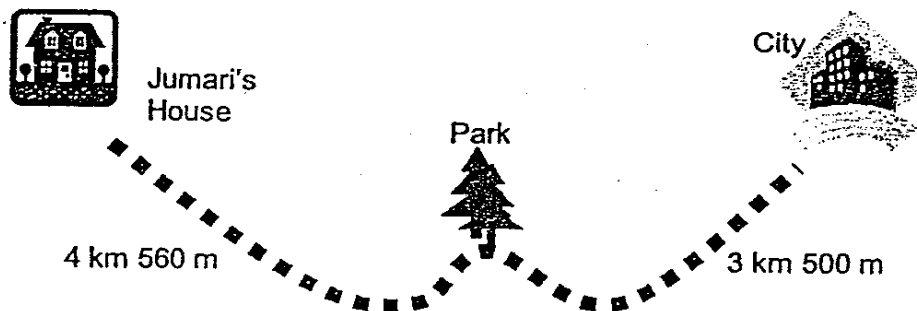

- (1) 7 km 60 m (2) 7 km 106 m
 (3) 8 km 60 m (4) 80 km 60 m

15. Mr Tan left his apartment at 7.30 a.m. He reached his office at 8.10 a.m. How long did he take to reach his office?

- | | |
|----------------|----------------|
| (1) 60 minutes | (2) 50 minutes |
| (3) 40 minutes | (4) 30 minutes |

16. Which of the following angles is greater than a right angle?

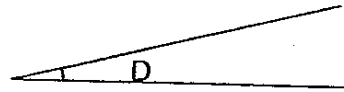
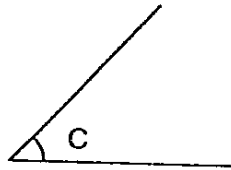
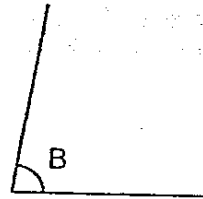
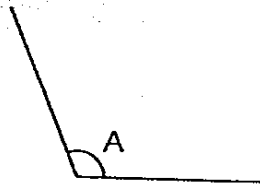

- | | |
|-------|-------|
| (1) A | (2) B |
| (3) C | (4) D |

17. How many angles are there inside the figure below?

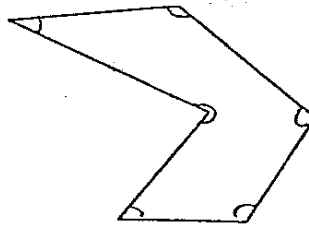

- | | |
|-------|-------|
| (1) 7 | (2) 6 |
| (3) 5 | (4) 4 |

18. Which of the figures below have the same perimeter?

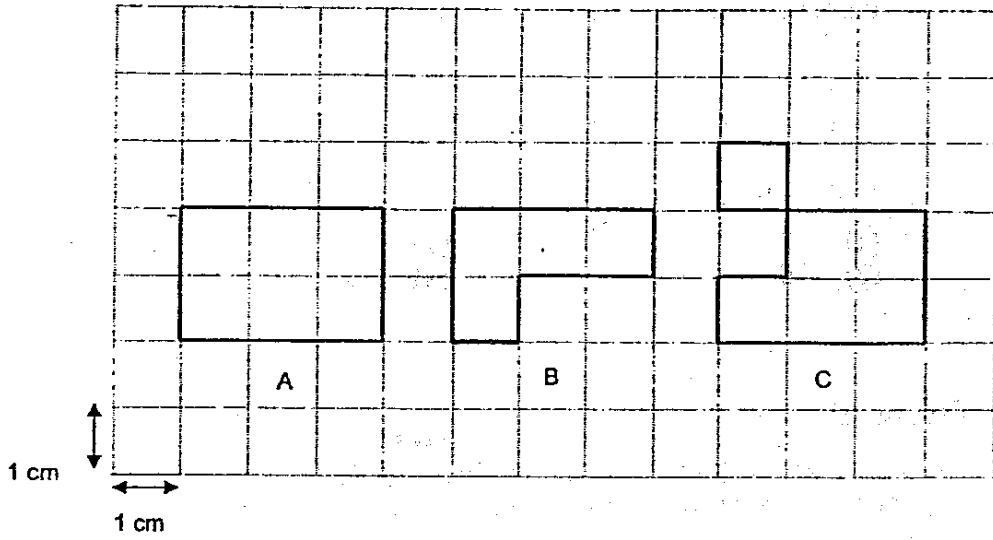

- (1) A and B (2) A and C
 (3) B and C (4) A, B and C

19. What is the area of the figure below?

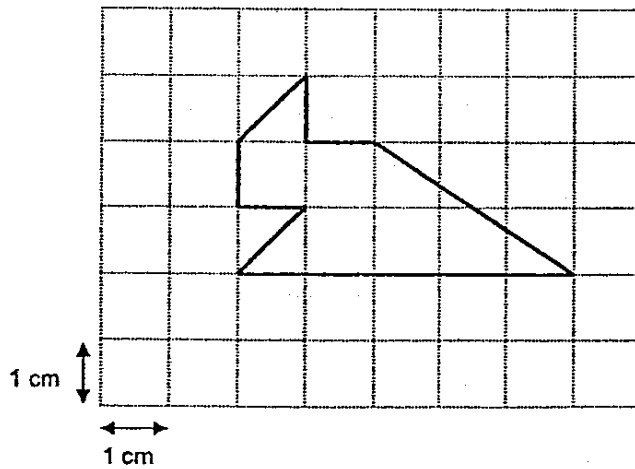

- (1) $5 \frac{1}{2} \text{ cm}^2$ (2) 6 cm^2
 (3) $6 \frac{1}{2} \text{ cm}^2$ (4) 7 cm^2

24

20. Siti wanted to buy 2 different coloured scarves. There were red, blue, green and yellow scarves in a shop. How many colour combinations of scarves could she buy?

(1) 7
(3) 5

(2) 6
(4) 4

Section B

Questions 21 to 40 carry 2 marks each. Write your answers in the blanks provided. For questions which require units, give your answers in the units stated.

(Total: 40 marks)

21. What is the smallest 4-digit even number which can be formed using all the digits 0, 3, 6 and 8?

Answer : _____

22. Arrange the following numbers in descending order.

5273 , 5723 , 5237 , 5327

Answer : _____

23. Find the difference between 2974 and 5002.

Answer : _____

24. Chris works 7 hours a day. He works 4 days in a week. If he is paid \$3 an hour, how much does he earn in 1 week?

Answer : \$ _____

25. There are 17 blue bags and 28 green bags. If there are 8 balls in each blue bag and 5 balls in each green bag, how many balls are there altogether?

Answer : _____

26. Sanjay bought a pair of gloves for \$42.30, a baseball bat for \$27.45 and a ball for \$4.20. How much did he spend on the 3 items?

Answer : \$ _____

27. A television set costs \$111.50 and a radio costs \$79.85. How much cheaper is the radio than the television set?

Answer : \$ _____

28. Study the table below.

Wire	Length
A	305 m
B	468 m
C	220 m

What is the difference in length between the longest and shortest wire?

Answer : _____ m

29. James travelled a total distance of 384 km on Monday, Tuesday and Wednesday. He travelled 100 km on Monday. The distance that he travelled on Tuesday was thrice as long as the distance he travelled on Wednesday. What was the distance he travelled on Wednesday?

Answer : _____ km

30. What is the mass of the parcel in grams?

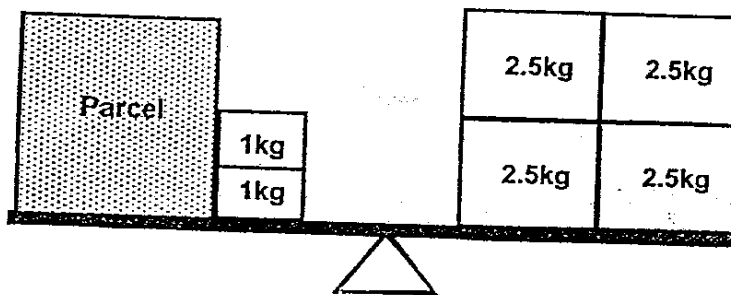

Answer : _____ g

31. The total mass of 3 packets of chocolate powder and 2 bottles of milk is 2 kg 400 g. The mass of each packet of chocolate powder is 300 g. What is the mass of 1 bottle of milk?

Answer : _____ g

32. Subtract 2 l 35 ml from 5 l 21 ml.

Answer : _____ l _____ ml

33. There was 6250 ml of water in a fish tank. Susan poured away 940 ml of water in the fish tank and added 390 ml of water later. How much water is there in the tank now?

Answer : _____ l _____ ml

34. Jason took 2 h 25 min to make his toy car. He took another 1 h 40 min to paint it. If he started making his car at 11.00 a.m., at what time did he finish painting his toy car?

Answer : _____ p.m.

35. Ai Ling exercises for 20 minutes everyday. How long does she exercise in one week?

Answer : ____ h ____ min

36. The bar graph shows the time taken by 4 children to finish a race.

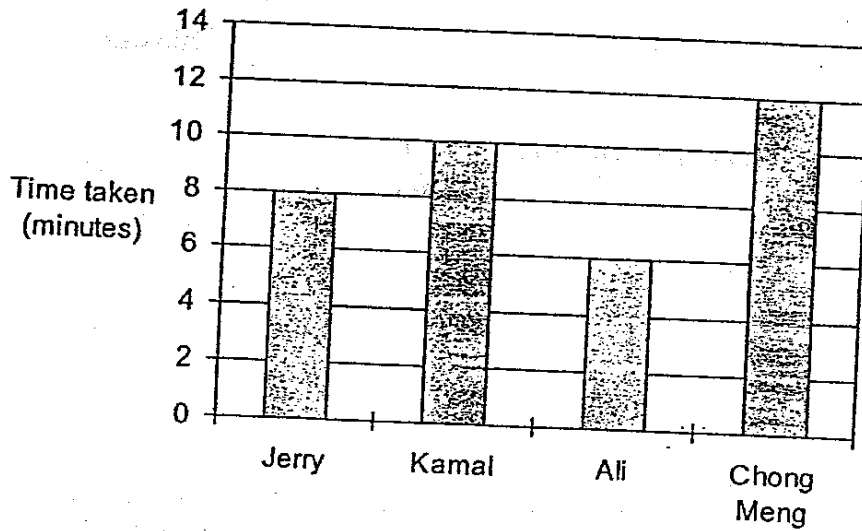

Who finished the race first?

Answer : _____

37. Which two of the following figures have the same number of right angles inside it?

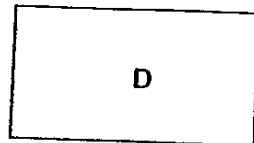
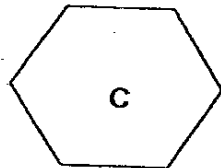
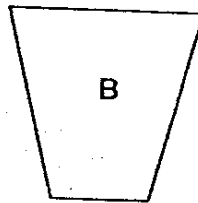
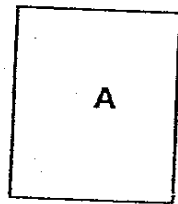

Answer : _____ and _____

38. If the area of a pond is 5 times as large as the figure below, what is the area of the pond?

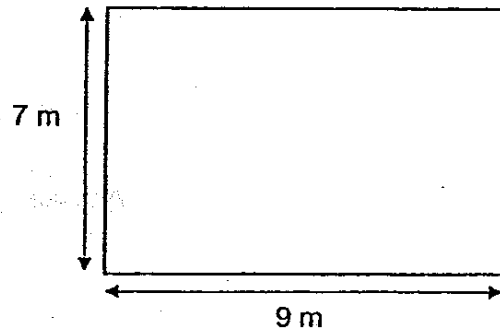

Answer : _____ m²

39. The figure below is made up of Square A and Rectangle B. The breadth of B is the same as the length of A. What is the perimeter of the figure?

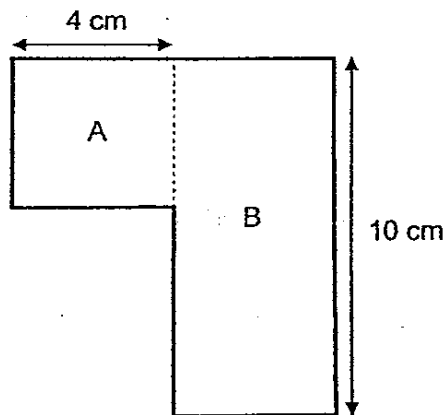

Answer : _____ cm

40. Mrs Chen has 5 children, Abe, Bell, Cino, Dan and Elle. Abe is the oldest. Dan is 4 years younger than Abe but 1 year older than Bell. Cino is 2 years older than Bell but 1 year younger than Elle. Who is the youngest child in the family?

Answer : _____

Section C

Questions 41 to 45 carry 4 marks each. Do these word problems carefully. Show your working in the space provided.

(Total: 20 marks)

41. Adam had \$18. Xinyi had 4 times as much money as Adam. If Xinyi spent \$57.50, how much money would she have left?

42. Trains in Platform A arrive at the train station every 3 minutes while trains in Platform B arrive at train station every 5 minutes. The train service starts at 8.00 a.m. everyday. What is the earliest time that the trains in Platform A and B arrive at the train station at the same time?

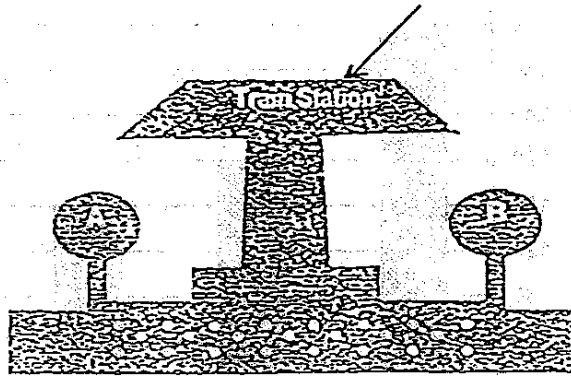

(Hint: Draw a Table)

43. The bar graph below shows the number of different types of books sold at June's bookshop last week.

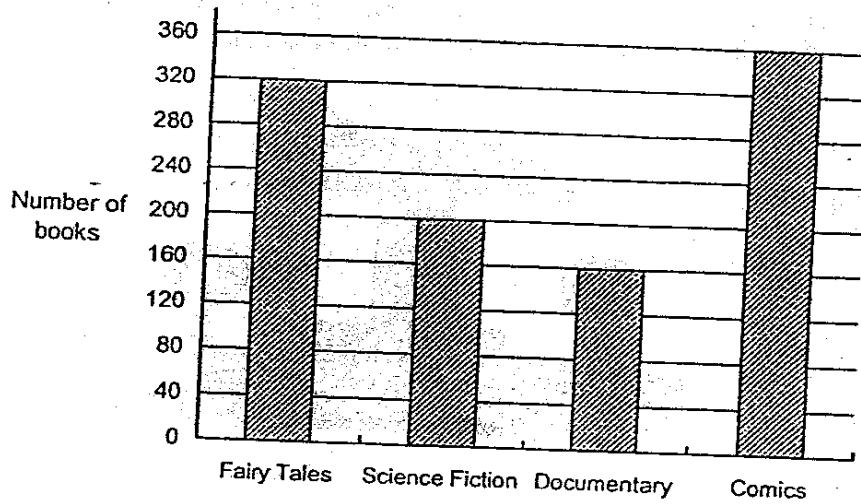

- (a) Which type of books was the most popular among the readers?

Answer:

- (b) How many more Fairy Tales than Science Fiction did June sell?

Answer:

- (c) If June sold 248 more Comics this week than last week. How many Comics did she sell this week?

Answer:

- (d) Which type of books was half the number of Fairy Tales sold?

Answer:

44. Squares A and B, each with a length of 3 cm, are cut out from a piece of cardboard as shown below.

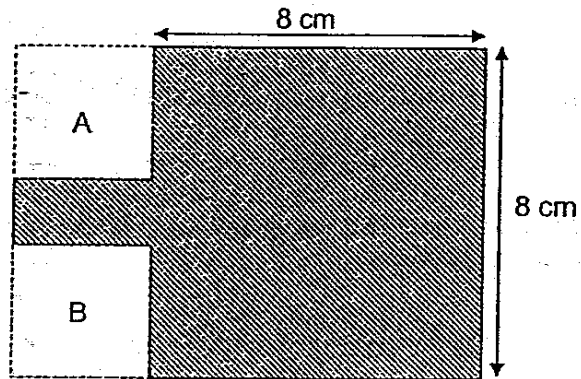

(a) What is the total area of Squares A and B?

(b) What is the area of the remaining cardboard?

45. A cake was cut equally into 16 pieces as shown in Figure A below. It was shared among Alisa, Betty and Caroline. Alisa took $\frac{1}{4}$ of the cake, Betty took $\frac{1}{2}$ of the cake and Caroline took the rest.

- (a) Use green coloured pencil to shade the fraction of the cake that Alisa took in Figure A.
- (b) Use blue coloured pencil to shade the fraction of the cake that Betty took in Figure A.

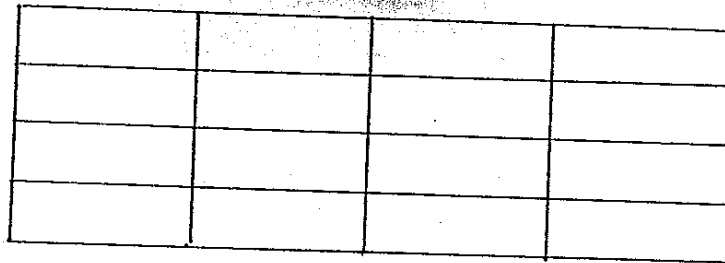

Figure A

- (c) What fraction of the cake did Caroline take?
- (d) Who got the biggest share of the cake?

☺ End of Paper ☺
Please Check Carefully

Answer Sheets
Nanyang Pri 3 SA2 / 2006 Maths

- | | | | | |
|-------|-------|-------|-------|-------|
| 1) 1 | 2) 2 | 3) 2 | 4) 4 | 5) 1 |
| 6) 4 | 7) 1 | 8) 4 | 9) 3 | 10) 4 |
| 11) 2 | 12) 4 | 13) 3 | 14) 3 | 15) 3 |
| 16) 1 | 17) 2 | 18) 1 | 19) 4 | 20) 2 |

21. 3068

22. 5723, 5327, 5273, 5237

23. $5002 - 2974 = 2028$

24. $7 \times 4 = 28\text{hours}$
 $28\text{hours} \times \$3.00 = \84.00

25. Blue bags = $17 \times 8 = 136$ balls
Green bags = $28 \times 5 = 140$ balls
 $136 + 140 = \underline{276}$ balls altogether

26. $\$(42.30 + 27.45 + 4.20) = \73.95

27. $\$(111.50 - 79.85) = \31.65

28. B = 468m
C = 220m
 $468 - 220 = 248\text{m}$

29. Total = 384km
Monday = 100km
= $384 - 100$
= 284km
Tue + Wed = 3 units + 1 unit = 4units
 $284\text{km} \div 4 = 71\text{km}$

30. $2.5\text{kg} \times 4 = 10\text{kg}$
 $10\text{kg} - 2\text{kg} = 8\text{kg}$
= 8000g

31. 1 packet of chocolate powder = 300g
3 packets = $300 \times 3 = 900\text{g}$
2kg 400g = $2400\text{g} - 900\text{g}$
= $1500\text{g} \div 2$
= 750g

32. $5\text{l } 21\text{ml} - 2\text{l } 35\text{ml}$
 $5021\text{ml} - 2035\text{ml} = 2986\text{ml}$
= 2l 986ml

33. $(6250 - 940)\text{ml} = 5310\text{ml}$
 $(5310 + 390)\text{ml} = 5700\text{ml}$
= 5l 700ml

34. $2\text{h } 25\text{min} + 1\text{h } 40\text{min} = 4\text{hrs } 5\text{min}$
 $11.00\text{am} + 4\text{hrs } 5\text{min} = 3.05\text{pm}$

$$\begin{aligned}
 35. \quad 1 \text{ day} &= 20 \text{ mins} \\
 7 \text{ days} &= 20 \times 7 \\
 &= 140 \text{ mins} \\
 &= 2 \text{ hrs } 20 \text{ mins}
 \end{aligned}$$

36. Ali

37. A and D

$$\begin{aligned}
 38. \quad 7 \times 9 &= 63 \text{ m}^2 \\
 &= 63 \text{ m}^2 \times 5 \\
 &= 315 \text{ m}^2
 \end{aligned}$$

$$\begin{aligned}
 39. \quad 10 - 6 &= 4 \\
 4 + 4 + 4 + 4 + 6 + 4 + 10 &= 36 \text{ cm}
 \end{aligned}$$

40. Bell

$$\begin{aligned}
 41. \quad \text{Adam} &= \$18.00 \\
 \text{Xinyi} &= \$18 \times 4 \\
 &= \$72.00 \\
 &= \$(72.00 - 57.50) \\
 &= \$14.50
 \end{aligned}$$

She has \$14.50 left

$$\begin{aligned}
 42. \quad \text{Trains in Platform A} &= 3 \text{ mins} \\
 \text{Trains in Platform B} &= 5 \text{ mins}
 \end{aligned}$$

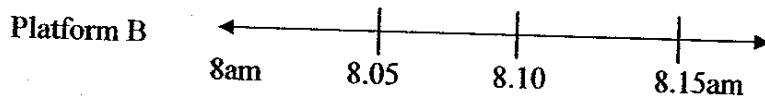
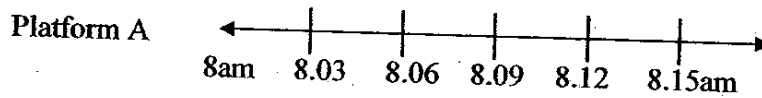

43a. Comics Books

$$43b. \quad 320 - 200 = \underline{120 \text{ more}} \text{ Fairy Tales books sold in June.}$$

$$43c. \quad 360 + 248 = \underline{608 \text{ comics book}} \text{ sold this week.}$$

$$\begin{aligned}
 43d. \quad \text{Fairy Tales Book} &= 320 \div 2 \\
 &= 160 \text{ books } \underline{\text{(Documentary)}}
 \end{aligned}$$

44a. Total Area A+B = $(3 \times 3) \times 2$
 $= 9 \times 2$
 $= \underline{18\text{cm}^2}$

44b. $8 \times 8 = 64\text{cm}^2$
 $8 - 6 = 2\text{cm}$
 $3 \times 2 = 6\text{cm}^2$
 $64 + 6 = 70\text{cm}^2$
 The remaining cardboard is 70cm²

45a.

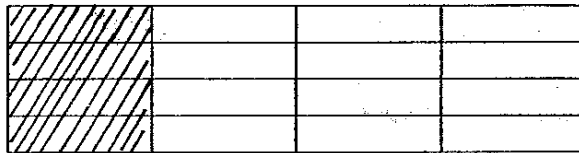

$\frac{1}{4} = \frac{4}{16}$ (Alisa)

45b.

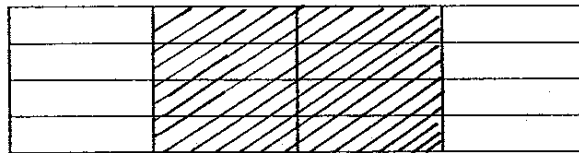

$\frac{1}{2} = \frac{8}{16}$ (Betty)

45c. $8 + 4 = 12$
 Caroline = $16 - 12 = 4$ pcs

45d. Betty got the biggest share of the cake. (8 pcs)