



NANYANG PRIMARY SCHOOL

**SECOND SEMESTRAL EXAMINATION
2011**

**PRIMARY 3
MATHEMATICS**

DURATION: 1 HOUR 45 MINUTES

Section A	/ 40
Section B	/ 40
Section C	/ 20

Total:	/ 100
---------------	--------------

Name: _____ ()

Class: Primary 3 ()

Date: _____

Parent's Signature:

DO NOT OPEN THIS BOOKLET UNTIL YOU ARE TOLD TO DO SO.

FOLLOW ALL INSTRUCTIONS CAREFULLY.

ANSWER ALL QUESTIONS.

Section A

Questions 1 to 20 carry 2 marks each. For each question, four options are given. One of them is the correct answer. Make your choice (1, 2, 3 or 4). Shade the oval (1, 2, 3 or 4) on the Optical Answer Sheet.

(Total: 40 marks)

1. Which of the following has the same value as 2107?

- (1) 21 thousands + 7 ones (2) 20 hundreds + 10 tens + 7 ones
(3) 20 hundreds + 17 ones (4) 2 thousands + 10 hundreds + 7 ones

2. The table below shows the number of participants who had signed up for the various sports that would be conducted at a Sports Carnival.

Sport	Number of participants
Skipping	5658
Jogging	4987
Swimming	5748

How many more participants signed up for the most popular sport than the least popular sport?

- (1) 671 (2) 771
(3) 761 (4) 861

3. Ahmad has 4292 stamps and Govin has 2464 stamps. How many stamps must Ahmad give to Govin so that both boys will have the same number of stamps?

- (1) 914 (2) 1828
(3) 2146 (4) 3378

4. Mr Ho earned \$358 in a day.
If he earned the same amount of money each day, how much money would he earn in a week?

- (1) \$2156 (2) \$2456
(3) \$2506 (4) \$4256

5. Fang Yu had 376 cards.
She arranged them equally into packs of 8.
How many packs of cards were there?

- (1) 47 (2) 48
(3) 2968 (4) 3040

6. Muthu bought some items at the supermarket.
The receipt below shows the price of each item and the total amount paid by Muthu.
How much did Muthu pay for the dustpan?

Receipt	
<u>Items</u>	<u>Price</u>
Apple	\$0.55
Ice-cream	\$7.80
Dustpan	<input data-bbox="810 1653 906 1720" type="text" value="?"/>
Total	\$18.95

- (1) \$5.65 (2) \$8.35
(3) \$10.60 (4) \$11.70

7. Ali wanted to buy some magazines.
Each magazine cost \$8 and he needed \$14 more to buy
10 such magazines.
How much money did he have at first?

- | | |
|----------|----------|
| (1) \$60 | (2) \$66 |
| (3) \$80 | (4) \$94 |

8. Ghandi went to an arcade on Saturday and Sunday.
He spent \$56 on Saturday.
He spent \$22.50 more on Sunday than on Saturday.
If he gave the cashier 2 fifty-dollar notes on Sunday, how much change
did he receive?

- | | |
|-------------|-------------|
| (1) \$78.50 | (2) \$66.50 |
| (3) \$32.50 | (4) \$21.50 |

9. Aminah completed a race by running a distance of 8 km 50 m.
Jaiho ran a distance of 6 km 120 m.
How much further must Jaiho run in order to complete the race?

- | | |
|-----------------|-----------------|
| (1) 1 km 930 m | (2) 2 km 380 m |
| (3) 14 km 620 m | (4) 14 km 170 m |

10. Aimee's watch is 20 minutes slower than the clock in the classroom.
The clock shows 9.15 a.m.
What time will Aimee's watch show 30 minutes later?

- | | |
|---------------|----------------|
| (1) 9.25 a.m. | (2) 9.35 a.m. |
| (3) 9.45 a.m. | (4) 10.05 a.m. |

11. What is the mass of the pie?

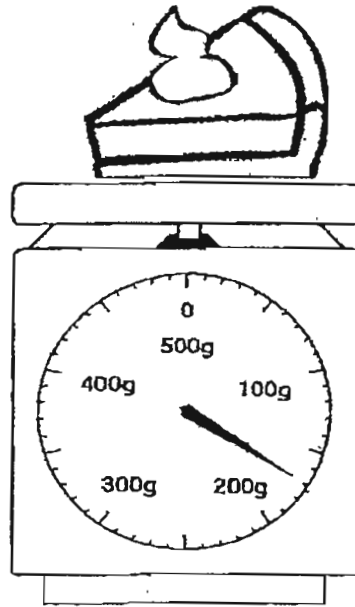

- (1) 107 g (2) 170 g
 (3) 107 kg (4) 170 kg

12. Mrs Chen travelled from the bus station to the school to fetch her son. She then brought him to the playground to play before going home. What was the total distance travelled by Mrs Chen if she took the shortest possible route?

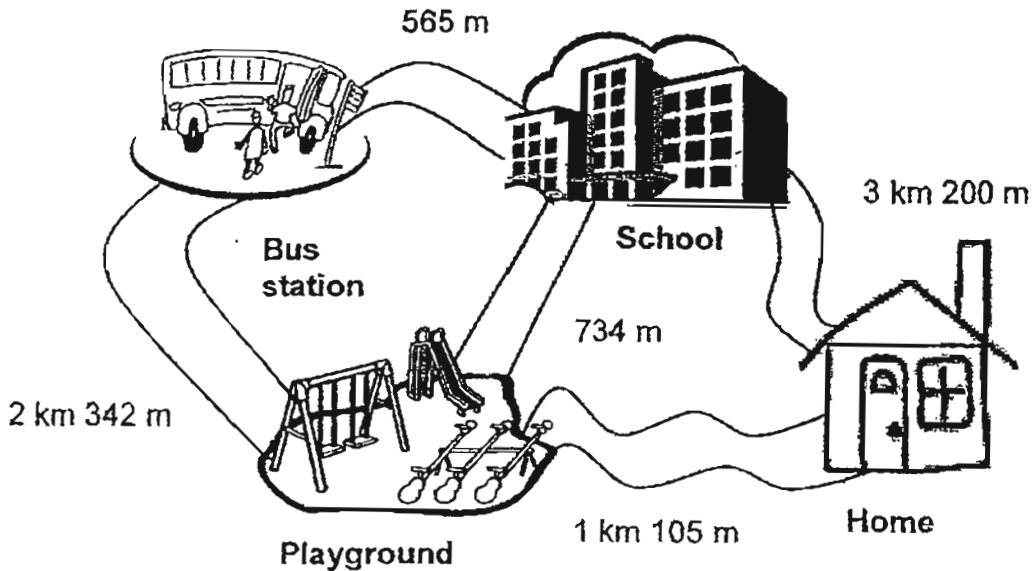

- (1) 1 km 299 m (2) 2 km 404 m
 (3) 2 km 304 m (4) 3 km 765 m

13. Latifah drank 1250 ml of water each day.
If Latifah drank the same amount of water each day, how much water would she drink in 5 days?

- (1) 6 / 255 ml (2) 6 / 250 ml
(3) 62 / 50 ml (4) 625 /

14. There was 560 ml **less** lemonade in Jug A than Jug B.
The two jugs contained 3580 ml of lemonade in all.
How many millilitres of lemonade were there in Jug A?

- (1) 1510 ml (2) 2070 ml
(3) 2460 ml (4) 3020 ml

15. Study the figure below.
What fraction of the figure is shaded?

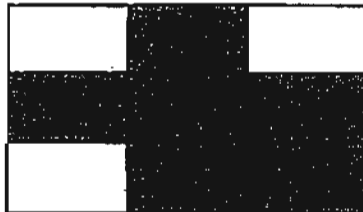

- (1) $\frac{1}{5}$ (2) $\frac{1}{3}$
(3) $\frac{2}{3}$ (4) $\frac{3}{4}$

16. Which one of the following fractions is an equivalent fraction of $\frac{4}{6}$?

(1) $\frac{1}{3}$

(2) $\frac{2}{6}$

(3) $\frac{4}{5}$

(4) $\frac{8}{12}$

17. Alan counted the number of pupils who visited the school dental clinic daily.

The bar graph below shows the number of pupils who visited the dental clinic on the 4 days.

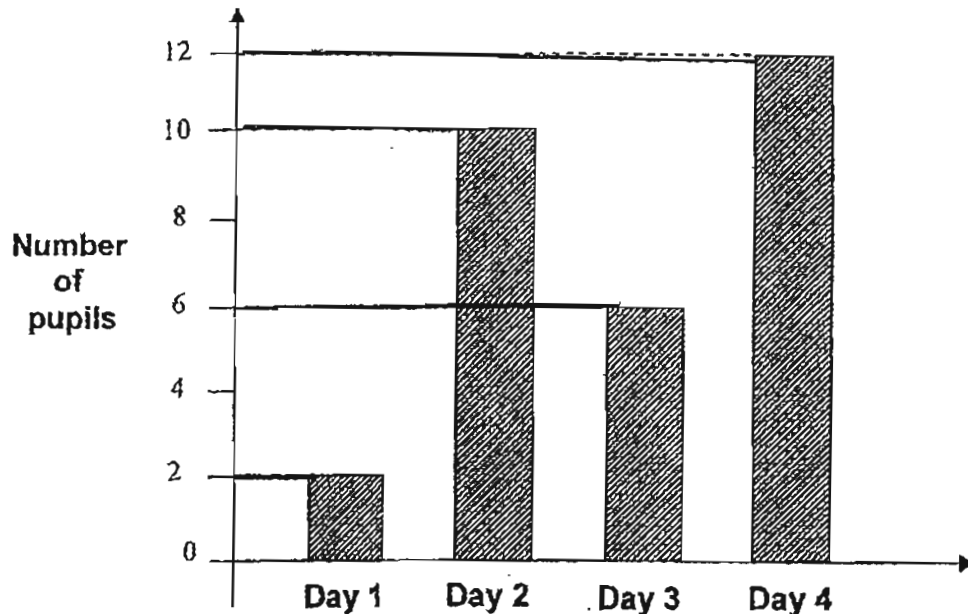

Which of the following statements is true?

- (1) 10 more children visited the dental clinic on Day 2 than Day 3.
- (2) The most number of children that visited the dental clinic was on Day 2.
- (3) The total number of children who visited the dental clinic on Day 1 and Day 3 was more than the number of children who visited the dental clinic on Day 2.
- (4) The total number of children who visited the dental clinic on Day 1 and Day 2 was the same as the number of children who visited the dental clinic on Day 4.

18. Study the figure carefully.

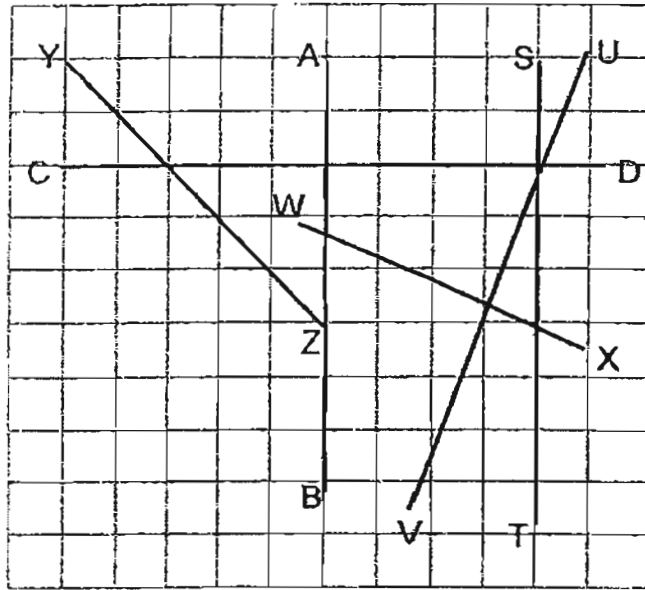

Which line is both parallel to Line AB and perpendicular to Line CD?

- (1) Line ST
- (2) Line UV
- (3) Line WX
- (4) Line YZ

19. Study the figure below carefully.
How many right angles are there inside the figure?

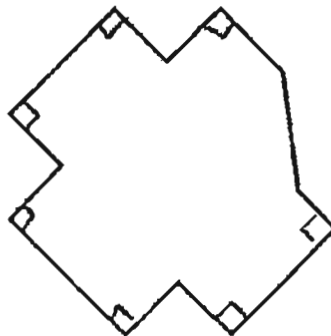

- (1) 6
- (2) 7
- (3) 10
- (4) 12

20. Look at the figure below.
What is the perimeter of the figure?

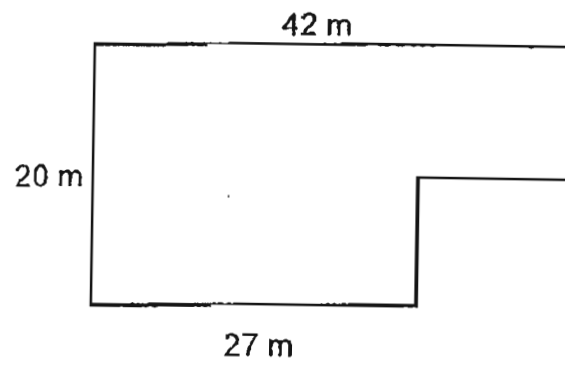

- (1) 82 m (2) 89 m
(3) 109 m (4) 124 m

Section B

Questions 21 to 40 carry 2 marks each. Show your working clearly in the space below each question and write your answers in the spaces provided. For questions which require units, give your answers in the units stated.

(Total: 40 marks)

21. Write 5348 in words.

22. Arrange the following numbers in **descending** order:

9364	9643	9634	9346
------	------	------	------

23. Complete the number pattern as shown below.

2, 6, 14, _____, 62, _____

24. David had 1857 stickers.
He had 2466 fewer stickers than Andy.
How many stickers did they have altogether?

Answer : _____

25. Andy, Bala and Chandra had a total of 2400 marbles.
Andy and Bala had a total of 646 marbles.
Bala and Chandra had a total of 1923 marbles.
How many marbles did Bala have?

Answer : _____

26. Form the greatest 4-digit **even** number using the digits provided.
(You can use each digit **once** only).

6	3	7	2	4
---	---	---	---	---

Answer : _____

27. Susan used 154 beads to make a necklace.
How many beads must she use to make 6 such necklaces?

Answer : _____

28. Abdullah baked 231 cookies.
He packed them equally into 9 jars.
How many cookies were not packed into the jars?

Answer : _____

29. Jane changed 2 ten-dollar notes for 3 five-dollar notes and
some fifty-cent coins.
How many fifty-cent coins did she receive?

Answer : _____

30. Lynn had \$43.95 in her wallet at first.
Her mother gave her 5 five-dollar notes, 8 twenty-cent coins
and 14 five-cent coins.
How much money did Lynn have in the end?

Answer : \$ _____

31. A tailor had a piece of cloth which was half a metre long.
After using 30 cm of the cloth, how much cloth did he have left?

Answer : _____ cm

32. Celine mixed 5 l 375 ml of water with some lemon syrup to
make 8 l of lemonade.
How much more water than lemon syrup was used?
Express your answer in litres and millilitres.

Answer : _____ l _____ ml

33. Arrange the fractions in order. Begin with the smallest fraction.

$$\frac{1}{6}, \quad \frac{3}{4}, \quad \frac{5}{12}, \quad \frac{1}{2}$$

34. Shuli ate $\frac{1}{3}$ of a watermelon.

Her brother ate $\frac{1}{2}$ of the watermelon.

What fraction of the watermelon was left?

Answer : _____

35. Three boys ate 206 sweets altogether.
Tom ate 16 more sweets than Xie Min.
Hariff ate 24 more sweets than Tom.
How many sweets did Xie Min eat?

Answer : _____

36. The bar graph below shows the number of seashells collected by four children.

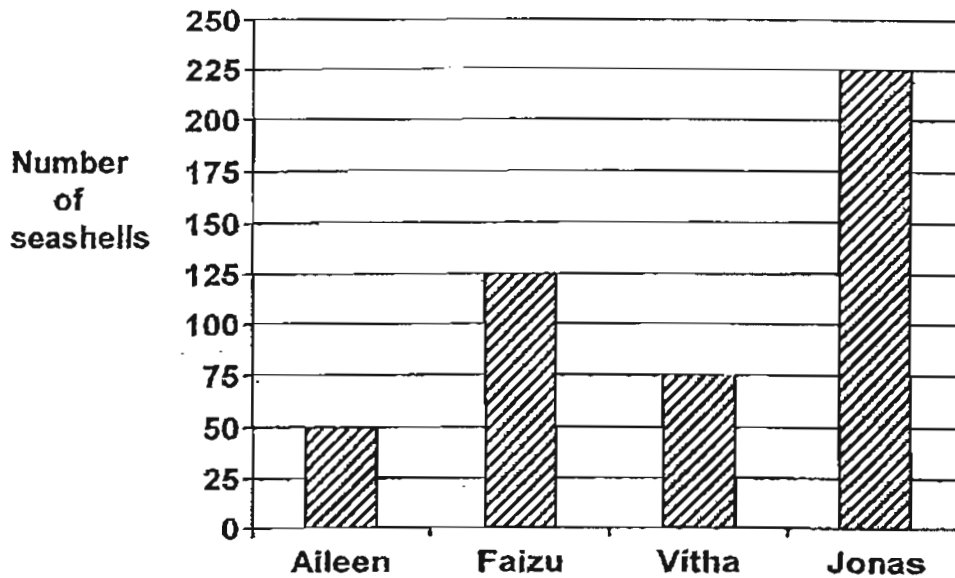

Fill in the blank with the correct answer.

The total number of seashells collected by Faizu and Vitha is _____ times as many as the number of seashells collected by Aileen.

Answer : _____

37. Study the figure carefully.
How many angles in the figure are smaller than a right angle?

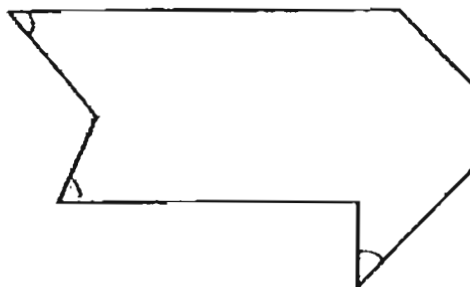

Answer : _____

38. Study the tissue box below.
How many right angles can you find on the shaded face of the box?

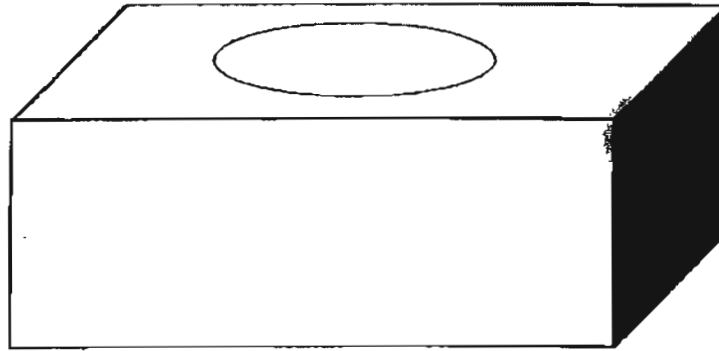

Answer : _____

39. Study the figure carefully.
What is the area of the shaded figure?

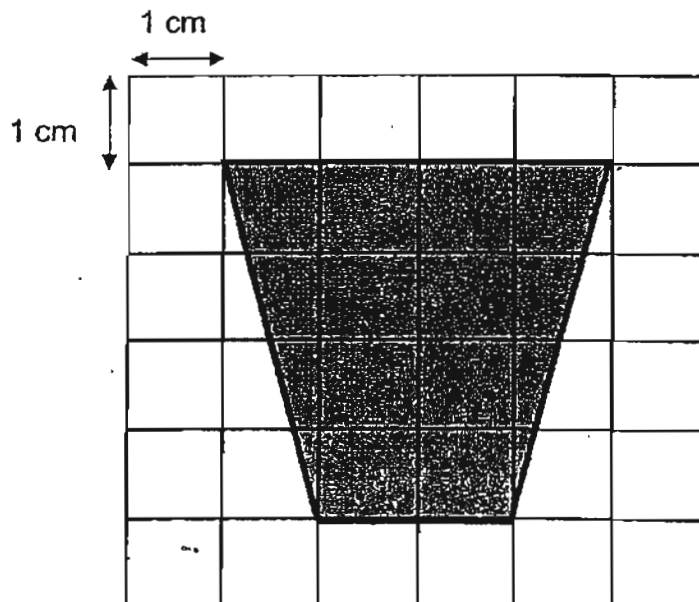

Answer : _____ cm^2

40. The square tile is made up of 2 rectangular tiles.
What is the length of the square tile if the area of the rectangular tile is 32 cm^2 ?

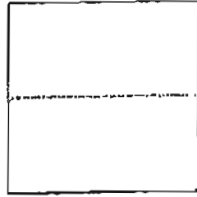

Square Tile

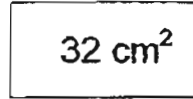

Rectangular Tile

Answer : _____ cm

Section C

Questions 41 to 45 carry 4 marks each. Do these word problems carefully.
Show your working clearly in the space provided below each question.

(Total: 20 marks)

41. A printer cost \$160 less than a camera.
A computer cost thrice as much as the camera.
If the printer cost \$860, what was the total cost of the printer, computer and camera?
42. The mass of a box containing a steel ball is 3550 g.
When Mr Lim puts in 2 more such steel balls into the box the mass of the box and 3 identical steel balls is 5900 g.
What is the mass of the box?

43. Salim, Ernst and Matthew took part in a card-making competition. Salim took 1 hour 27 minutes to complete his card. Ernst took 35 minutes more than Salim but 12 minutes less than Matthew.
- a) How long did Matthew take to complete his card?
 - b) How much longer did Matthew take than Salim to complete the card?

44. Ling Ling had 4200 stamps at first. After giving Mei Hui 950 stamps, Ling Ling still had 165 more stamps than Mei Hui. How many stamps did Mei Hui have at first?

45. Zorah spent \$58 on a total of 12 pizzas.
A Hawaiian pizza cost \$2 more than a Seafood pizza.
If one Hawaiian pizza cost \$6, how many Seafood pizza did she buy?

☺ End of Paper ☺
Please Check Carefully



ANSWER SHEET

EXAM PAPER 2011

**SCHOOL : NANYANG
SUBJECT : PRIMARY 3 MATHEMATICS**

TERM : SA2

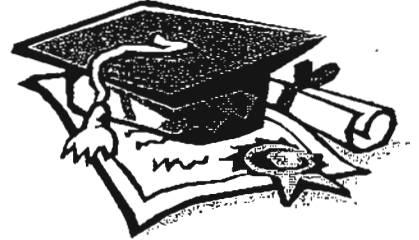

Q1	Q2	Q3	Q4	Q5	Q6	Q7	Q8	Q9	Q10	Q11	Q12	Q13	Q14	Q15	Q16	Q17
2	3	1	3	1	3	2	4	1	1	2	2	2	1	3	4	4

Q18	Q19	Q20
1	2	4

21) Five thousand, three hundred and forty-eight

22) 9643, 9634, 9364, 9346 23) 30, 126 24) 6180 25) 169

26) 7642 27) 924 28) 6 29) 10 30) \$71.25 31) 20m

32) 2L 150ml 33) $1/6$, $5/12$, $1/2$, $3/4$ 34) $1/6$ 35) 50

36) 4 37) 3 38) 4 39) 12cm^2 40) 8cm

41) $\$860 + \$160 = \$1020$
 $\$1020 \times 3 = \3060
 $\$860 + \$1020 = \$1880$
 $\$1880 + \$3060 = \$4940$

The total cost of the printer, computer and camera is \$4940.

42) $5900 - 3550 = 2350$
 $2350 \div 2 = 1175$
 $3550 - 1175 = 2375$

The box is 2350g.

43) a) $1\text{h } 27\text{min} + 35\text{min} = 1\text{h } 62\text{min}$
 $2\text{h } 2\text{min} + 12\text{min} = 2\text{h } 14\text{min}$
Matthew took 2h 14min to complete the card.

b) $2\text{h } 14\text{min} - 1\text{h } 27\text{min} = 1\text{h } 74\text{min}$
 $1\text{h } 74\text{min} - 1\text{h } 27\text{min} = 47\text{min}$

Matthew took 47min longer than Salim to complete the card.

$$44) 4200 - 950 = 3250$$

$$3250 - 165 = 3085$$

$$3085 - 950 = 2135$$

Mei Hui had 2135 stamps at first.

45)Hp	cost	SP	cost	Total no.of pizza	Total cost
7	\$42	5	\$20	12	\$62
6	\$36	6	\$24	12	\$60
5	\$30	7	\$28	12	\$58

She bought 7 seafood pizzas.

Check

$$\$6 \times 7 = \$42$$

$$\$4 \times 5 = 20$$

$$5 + 7 = 12$$

$$\$42 + \$20 = \$62$$

$$6 \times \$6 = \$36$$

$$6 \times \$4 = \$24$$

$$6 + 6 = 12$$

$$\$36 + \$24 = \$60$$

$$5 \times \$6 = 30$$

$$7 \times \$4 = \$28$$

$$7 + 5 = 12$$

$$\$30 + \$28 = 58$$