

CATHOLIC HIGH SCHOOL
END-OF-YEAR EXAMINATION (2020)
PRIMARY THREE
MATHEMATICS

Name : _____ ()

Class : Primary 3 _____

Date : 2 November 2020

Total time : 1 h 45 min

40 questions

80 marks

Parent's signature : _____

BOOKLET A	30
BOOKLET B	34
BOOKLET C	16
Total Marks	80

INSTRUCTIONS TO CANDIDATES

Do not turn over this page until you are told to do so.

Follow all instructions carefully.

Answer all questions.

Shade your answers in the Optical Answer Sheet (OAS) provided.

This booklet consists of 19 printed pages excluding the cover page.

Section A

Questions 1 to 15 carry 2 marks each. For each question, four options are given. One of them is the correct answer. Make your choice (1, 2, 3 or 4). Shade the correct oval (1, 2, 3 or 4) on the Optical Answer Sheet (OAS). All diagrams are not drawn to scale. (30 marks)

1. What is eight thousand, eight hundred and eight in numerals?

(1) 8080

(2) 8800

(3) 8808

(4) 8880

()

2. $7000 + \underline{\hspace{2cm}} + 56 = 7356$

(1) 300

(2) 30

(3) 3

(4) 3000

()

3. Find the product of 272 and 4.

(1) 68

(2) 268

(3) 276

(4) 1088

()

4. 1450 is $\underline{\hspace{2cm}}$ more than 1290.

(1) 140

(2) 160

(3) 2640

(4) 2740

()

5. 6 groups of 9 = _____.
- (1) $6 \times 6 \times 6 \times 6 \times 6 \times 6 \times 6 \times 6 \times 6$
- (2) $9 \times 9 \times 9 \times 9 \times 9 \times 9$
- (3) $9 + 9 + 9 + 9 + 9 + 9$
- (4) $6 + 6 + 6 + 6 + 6 + 6 + 6 + 6 + 6$ ()
-
6. Meng bought 21 cookies. Willy bought 7 times as many cookies as Meng. How many cookies did Willy buy?
- (1) 14
- (2) 29
- (3) 3
- (4) 147 ()
-
7. $842 \div 4 =$ _____
- (1) 200 R42
- (2) 210
- (3) 210 R2
- (4) 212 ()
-
8. Elliot has 45 coins. Barry has thrice as many coins as him. How many coins does Barry have?
- (1) 15
- (2) 48
- (3) 90
- (4) 135 ()
-

9. Find the difference between $\frac{1}{3}$ and $\frac{5}{6}$.

(1) $\frac{1}{2}$

(2) $\frac{4}{9}$

(3) $\frac{4}{6}$

(4) $\frac{6}{9}$

()

10. Study the figure below carefully.

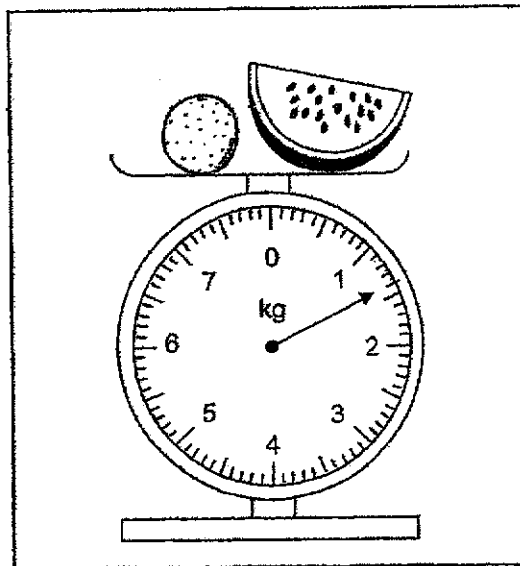

The mass of the orange is 170 g. What is the mass of the piece of watermelon?

(1) 1230 g

(2) 1370 g

(3) 1400 g

(4) 1570 g

()

11. Sam and his friends played badminton for 1 h 18 min. They started at 9.20 a.m. What time did they finish?
- (1) 8.02 a.m.
 - (2) 9.38 a.m.
 - (3) 10.20 a.m.
 - (4) 10.38 a.m. ()
-
12. Xiaofeng's height is 156 cm. Guoming's height is 10 cm taller than Xiaofeng. What is their total height?
- (1) 146 cm
 - (2) 166 cm
 - (3) 302 cm
 - (4) 322 cm ()
-
13. Madam Ong has 8 baskets. There are 64 lychees in each basket. How many lychees does she have altogether?
- (1) 8
 - (2) 56
 - (3) 72
 - (4) 512 ()
-

14. What is the volume of container A shown below?

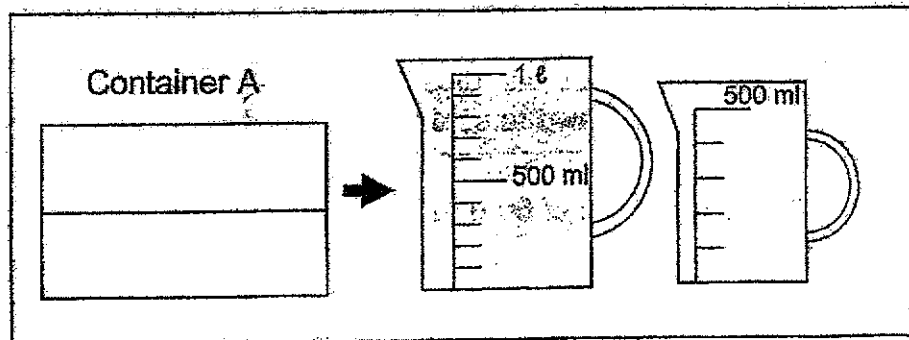

- (1) 1 l
 (2) 450 ml
 (3) 1 l 400 ml
 (4) 1 l 450 ml ()

15. Meiling distributed 294 candies equally among 6 friends. How many candies did each friend receive?

- (1) 42
 (2) 49
 (3) 1764
 (4) 2058 ()

END OF SECTION A

Section BDo not write
in this space

Questions 16 to 21 carry 1 mark each. Show your working clearly in the space and write the correct answers in the spaces provided. For questions which require units, give your answers in the units stated. All diagrams are not drawn to scale. (6 marks)

16. What is the value of 60 hundreds and 7 ones?

Ans: _____

17. Muthu finished his tuition class in the evening as shown on the clock below. The clock was 30 minutes slow.

The statement below is either true, false or not possible to tell from the information given. Put a tick (✓) in the correct column.

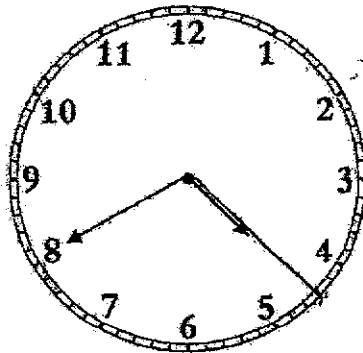

Statement	True	False	Not possible to tell
The actual time that Muthu finished his tuition class was 4.10 p.m.			

18. Draw 300 ml of water in the beaker.

Do not write in this space

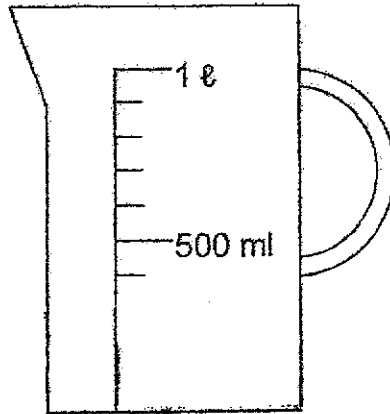

19. Study the 2 figures carefully. Each square is 1 square unit.

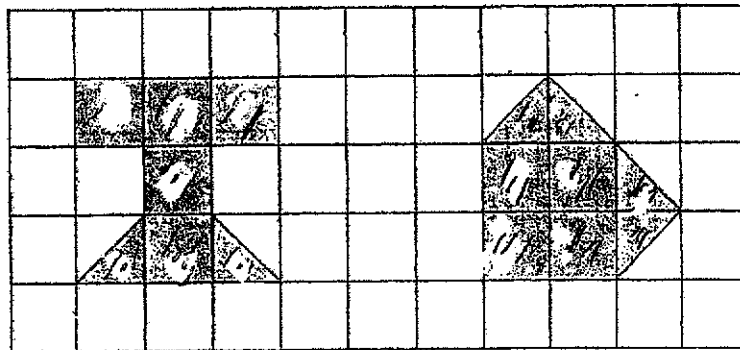

Figure A

Figure B

The statement below is either true, false or not possible to tell from the information given. Put a tick (✓) in the correct column.

Statement	True	False	Not possible to tell
Both figures have the same area.			

20. Express 4008 m in kilometres and metres.

Do not write
in this space

Ans: _____ km _____ m

21. Express $\frac{6}{8}$ in its simplest form.

Ans: _____

Total marks for questions 16 to 21

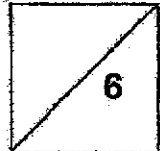

Questions 22 to 35 carry 2 marks each. Show your working clearly and write your answers in the spaces provided. For questions which require units, give your answers in the units stated. All diagrams are not drawn to scale. (28 marks)

Do not write
in this space

22. Study the number pattern.
What is the missing number?

2050, 2170, 2290, _____, 2530, 2650

Ans: _____

23. Form the smallest 4-digit even number with the following digits. All the digits must be used. Each digit can only be used once.

5

0

2

6

Ans: _____

24. Mrs Tan bought 154 cherries. She packed them equally into bags of 4. How many cherries were left unpacked?

Ans: _____

25. Raine started to exercise at 8.35 a.m. He stopped exercising at 10.15 a.m. How much time did he spend exercising?

Do not write
in this space

Ans: _____ h _____ min

26. Find the sum of $\frac{1}{10}$ and $\frac{3}{5}$.

Ans: _____

27. Alex and Gill shared some stickers equally. After Gill gave 29 stickers away and Alex bought 18 stickers, how many more stickers did Alex have than Gill?

Ans: _____

28. The bar graph below shows the number of bottle caps collected by 4 classes. Study the graph carefully. Do not write in this space

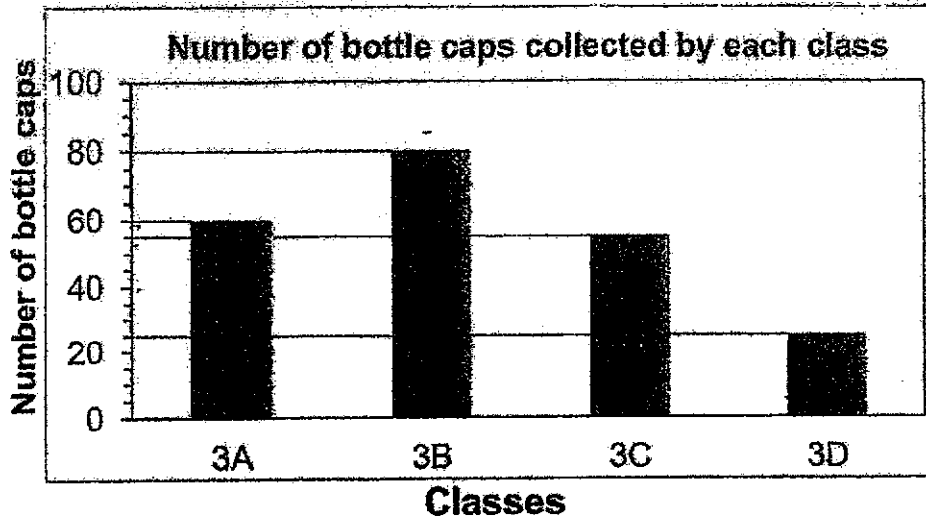

What is the total number of bottle caps collected by the 4 classes?

Ans: _____

29. A bakery sold a cupcake and a doughnut for \$12. Finn bought 4 cupcakes and 4 doughnuts. How much did he pay in all?

Ans:\$ _____

33. Max has 3 square papers. He places them side by side to form a rectangle. What is the perimeter of the rectangle?

Do not write
in this space

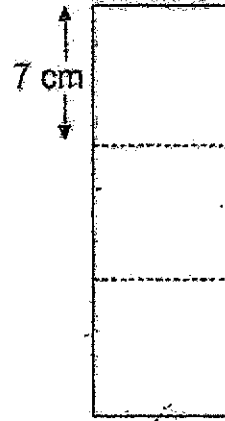

Ans: _____ cm

34. Mike bought a cheese burger for \$3.45 and a cone of ice cream for 85¢. How much did he spend altogether?

Ans:\$ _____

35. The bar graph below shows the favourite games of the students in Primary 3 Care. Study the graph carefully and answer questions (a) and (b).

Do not write
in this space

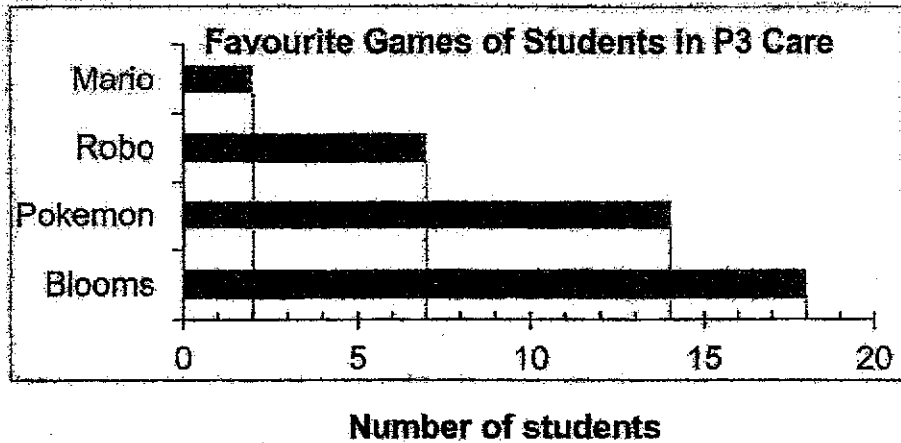

- (a) Which is the most popular game among the students in P3 Care?
- (b) Twice as many students love the game _____? as the game Robo. What game is this?

Ans: (a) _____

(b) _____



Total marks for questions 22 to 35

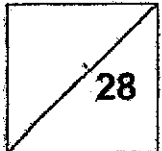

END OF SECTION B

Section C

For Questions 36 to 40, show your working clearly and write your answers in the spaces provided. The number of marks available is shown in brackets [] at the end of each question or part-question. All diagrams are not drawn to scale. (16 marks)

Do not write
in this space

36. Amy baked 438 pies and cookies. She baked 134 less cookies than pies. How many cookies did Amy bake?

Ans: _____ [3]



37. The following table shows a menu at a cafe.

Do not write
in this space

<u>Menu</u>	
6 pieces nuggets	—— \$4.50
1 chicken burger	—— \$3.55
1 pack of fries	—— \$2.05
1 cone of ice cream	—— \$1.20
1 large coke	—— \$2.95

Ivan bought 2 items on the menu. He paid \$10 and received \$2.55 change. What were the 2 items that he bought?

Ans: _____

and _____ [3]



38. 10 pins were placed in a straight line. The distance between each pin was equal. The distance between the 1st pin and the 10th pin was 198 cm.

Do not write
in this space

- a) What was the distance between the 1st pin and the 2nd pin?
b) What was the distance from the 4th to the 9th pin?

Leave your answer in metres and centimetres.

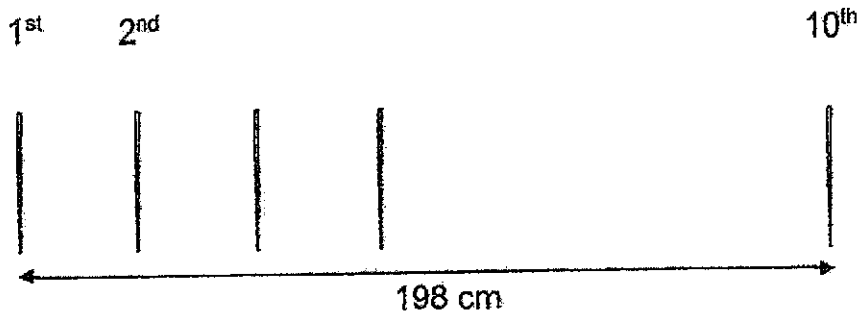

Ans: (a) _____ [1]

(b) _____ [2]

39. Ahmad made a 7-cm square card for his teacher. He coloured 16 cm^2 of the card. What is the area of the card that is not coloured?

Do not write
in this space

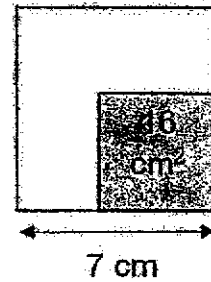

Ans: _____ [3]



40. Rectangles and triangles are arranged to form the figures below.

Do not write in this space

Study the pattern of the figures as shown below.

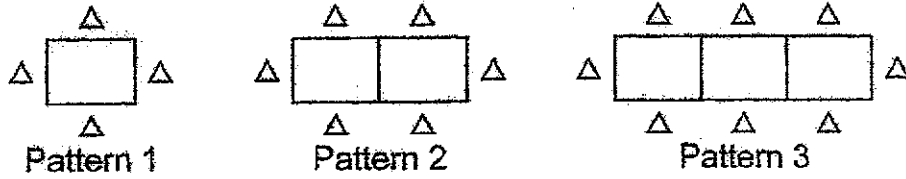

Pattern Number	Number of rectangles	Number of triangles
1	1	4
2	2	6
3	3	8
4	a)	b)

[2]

- a) Fill in the missing number of rectangles for Pattern 4.
- b) Fill in the missing number of triangles for Pattern 4.
- c) How many triangles are needed for Pattern 15?

Ans: (c) _____ [2]



END OF PAPER

ANSWER KEY**YEAR: 2020****LEVEL: PRIMARY 3****SCHOOL: CATHOLIC HIGH SCHOOL****SUBJECT: MATHEMATICS****TERM: SA2****BOOKLET A**

Q1	3	Q2	1	Q3	4	Q4	2	Q5	3
Q6	4	Q7	3	Q8	4	Q9	1	Q10	1
Q11	4	Q12	4	Q13	4	Q14	3	Q15	2

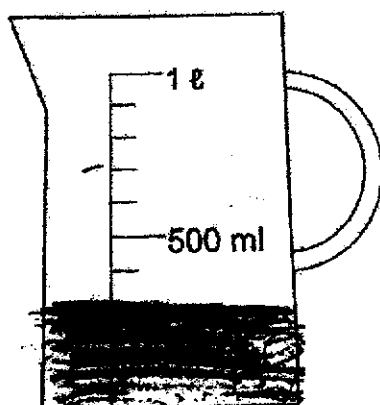
BOOKLET B**Q16. 6007****Q17. False****Q18.****Q19. True****Q20. 4Km 8m****Q21. $\frac{3}{4}$** **Q22. 2410****Q23. 2056****Q24. 2****Q25. 1 hour 40 minutes****Q26. $\frac{7}{10}$** **Q27. 47**

Q28. 220

Q29. \$48

Q30. $\frac{1}{9}, \frac{4}{7}, \frac{2}{3}$

Q31. $\frac{2}{3}$

Q32. 2 \$1 coins and 2 10¢ coins.

Q33. 56cm

Q34. 4.30

Q35.

a) Blooms

b) pokemon

SECTION C

Q36.

$$438 - 134 = 304$$

$$304 \div 2 = 152$$

Q37.

$$\$4.50 + \$3.55 = \$8.05$$

$$\$4.50 + \$2.05 = \$6.55$$

$$\$4.50 + \$2.95 = \$7.45$$

$$\$10 - \$2.55 = \$7.45$$

Ans: 6 pieces nuggets and 1 large coke

Q38.

$$a) 198 \div 9 = 22$$

$$b) 22 \times 5 = 110 \text{ cm}$$

$$110 \text{ cm} \approx 1 \text{ m } 10 \text{ cm}$$

Q39.

$$7 \times 7 = 49$$

$$49 - 16 = 33 \text{ cm}^2$$

Q40.

a) 4

b) 10

$$c) 15 \times 2 + 2 = 32$$