



NANYANG PRIMARY SCHOOL
SECOND SEMESTRAL EXAMINATION
2009

PRIMARY 4
MATHEMATICS

DURATION: 1 HOUR 45 MINUTES

| | |
|------------------|-------------|
| Section A | / 40 |
| Section B | / 40 |
| Section C | / 20 |

| | |
|---------------|--------------|
| Total: | / 100 |
|---------------|--------------|

Name: _____ ()

Class: Primary 4 ()

Date: 29 October 2009

Parent's Signature: _____

DO NOT OPEN THIS BOOKLET UNTIL YOU ARE TOLD TO DO SO.

FOLLOW ALL INSTRUCTIONS CAREFULLY.

ANSWER ALL QUESTIONS.

Section A

Questions 1 to 20 carry 2 marks each. For each question, four options are given. One of them is the correct answer. Make your choice (1, 2, 3 or 4). Shade the oval (1, 2, 3 or 4) on the Optical Answer Sheet.

(Total: 40 marks)

1. Which of the following has the same value as 8 hundreds, 34 ones, 6 tenths and 39 hundredths?

- | | |
|------------|-------------|
| (1) 879 | (2) 834.99 |
| (3) 894.39 | (4) 834.639 |

2. What is the value of $\frac{1}{12} + \frac{1}{4}$?

- | | |
|--------------------|-------------------|
| (1) $\frac{1}{48}$ | (2) $\frac{1}{8}$ |
| (3) $\frac{1}{6}$ | (4) $\frac{1}{3}$ |

3. Find the value of $\frac{7}{10} - \frac{1}{5}$.

- | | |
|--------------------|-------------------|
| (1) $\frac{1}{2}$ | (2) $\frac{3}{5}$ |
| (3) $\frac{9}{10}$ | (4) $\frac{6}{5}$ |

4. Which of the following is a common factor of 56 and 84?

(1) 6

(2) 7

(3) 8

(4) 12

5. Which of the following is a multiple of 6 and a factor of 54?

(1) 9

(2) 18

(3) 24

(4) 27

6. Which of the following numbers when rounded off to the nearest ten becomes 47 500?

(1) 47 445

(2) 47 497

(3) 47 505

(4) 47 551

7. The total length of 8 identical pieces of rope is 285 cm. What is the length of each piece of rope? Round off your answer to the nearest tenth.

(1) 35.622 cm

(2) 35.62 cm

(3) 35.6cm

(4) 35.7 cm

8. Which of the following figures is symmetrical?

(1)

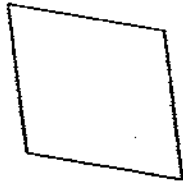

(2)



(3)



(4)

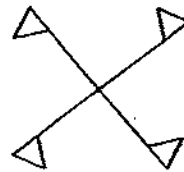

9. Which of the following shapes cannot tessellate?

(1)

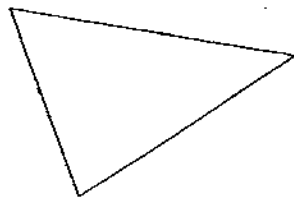

(2)

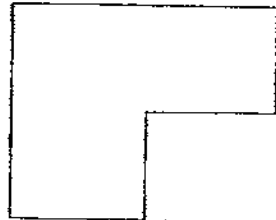

(3)

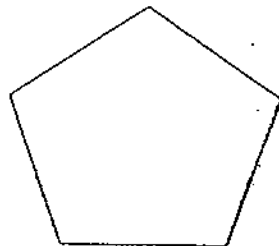

(4)



17. What is the unit shape of the following tessellation?

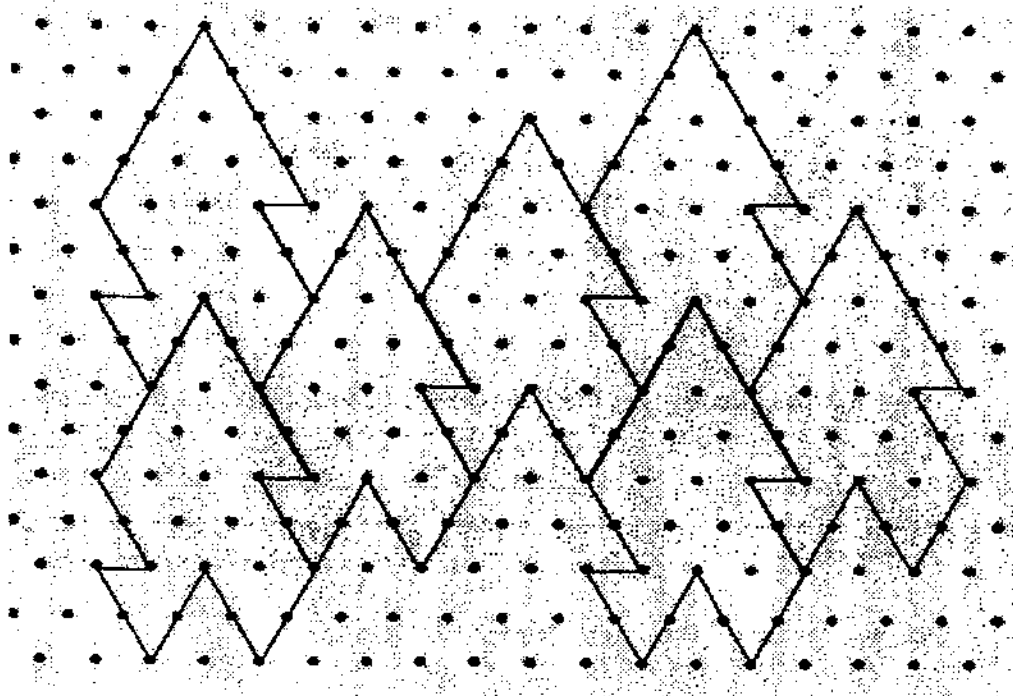

(1)

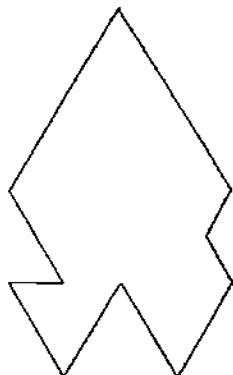

(2)

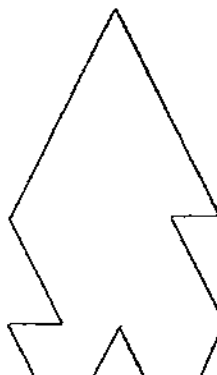

(3)

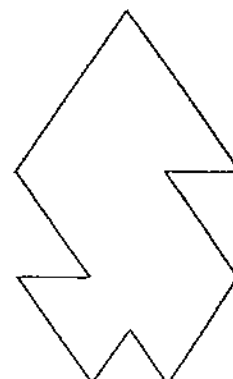

(4)

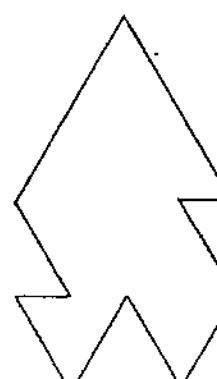

18. In the figure, ABCD is a rectangle. Find $\angle x$.

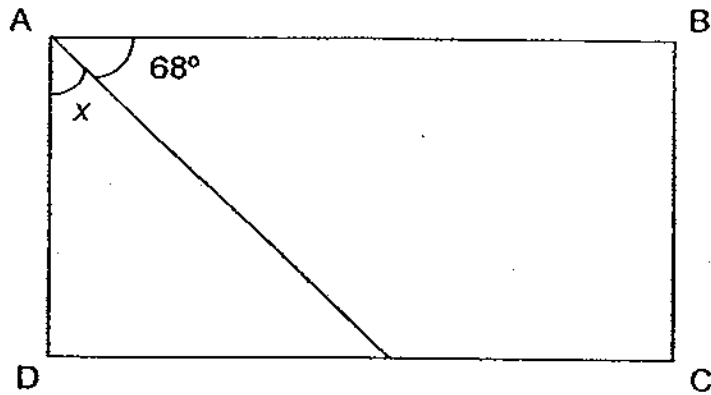

- | | |
|----------------|----------------|
| (1) 12° | (2) 22° |
| (3) 32° | (4) 45° |

19. The figure below is made up of a rectangle and 2 identical squares. The area of the shaded squares is $\frac{2}{5}$ of the area of the figure. Find the area of the rectangle.

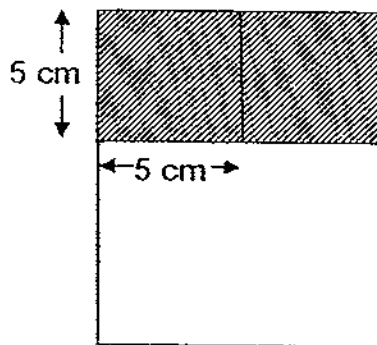

- | | |
|-----------------------|------------------------|
| (1) 25 cm^2 | (2) 50 cm^2 |
| (3) 75 cm^2 | (4) 125 cm^2 |

20. Sarah bought 3 durians for \$8.55 and 6 apples for \$4.60. What is the total cost of 1 durian and 3 apples?

(1) \$2.30
(3) \$5.15

(2) \$2.85
(4) \$13.15

Section B

Questions 21 to 40 carry 2 marks each. Show your working clearly in the space below each question and write your answers in the spaces provided. For questions which require units, give your answers in the units stated.

(Total: 40 marks)

21. Find the value of $9380 \div 7$.

Answer : _____

22. What is the missing number in the box?

$$\frac{5}{6} = \frac{\square}{18}$$

Answer : _____

23. What is $\frac{5}{8}$ of 72?

Answer : _____

24. Measure and write down the size of $\angle WXY$.

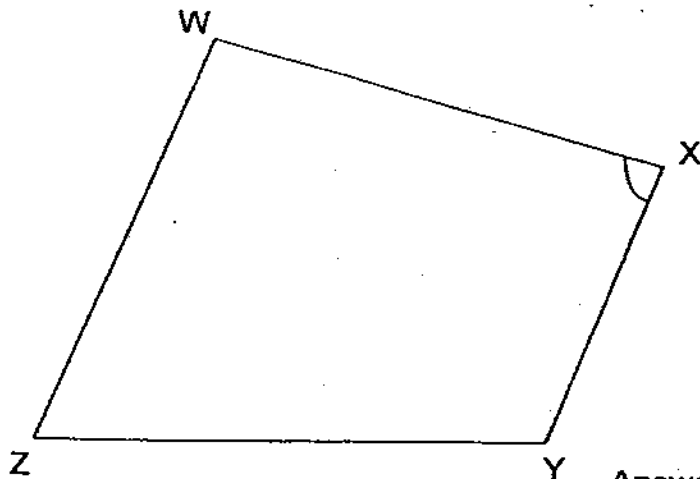

Answer : _____ °

25. In 105.286, what does the digit 8 stand for?

Answer : _____

26. The bar graph below shows the favourite ball games of some Primary 4 pupils. Study it carefully and answer the question below.

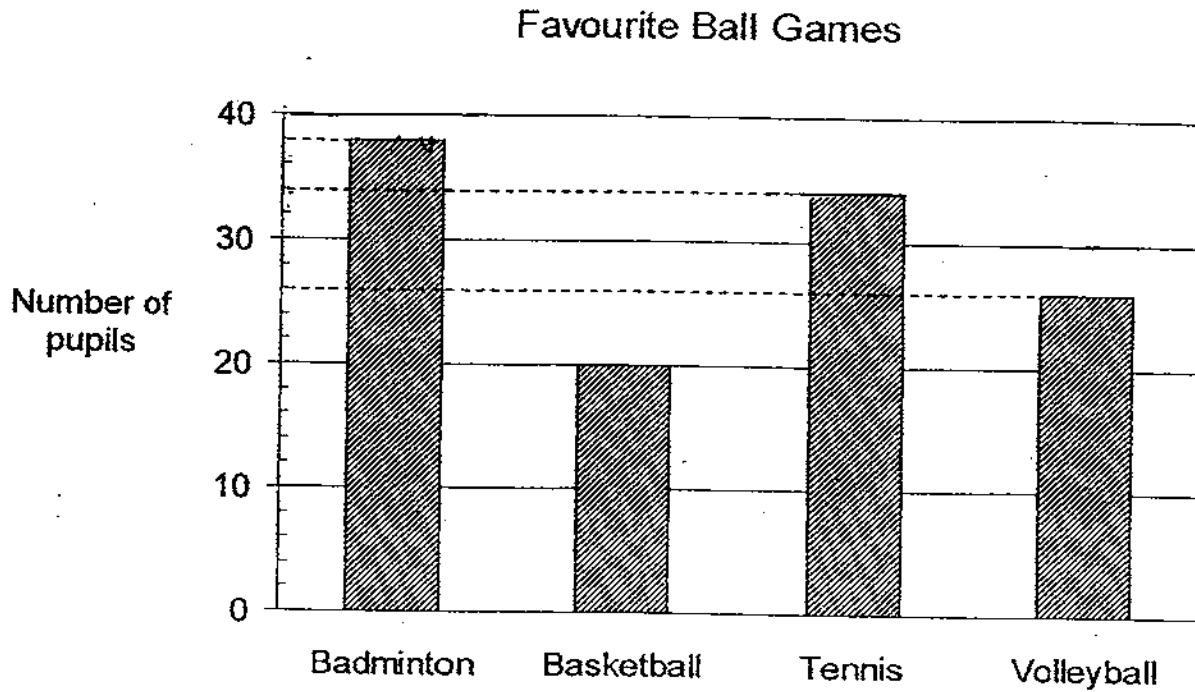

What is the difference between the number of pupils who prefer the least popular ball game to the most popular ball game?

Answer : _____

27. What is the first common multiple of 8 and 12?

Answer : _____

28. Anna, Bella and Charlie have a total amount of \$2585 in the savings account. Bella's savings is thrice that of Anna. If Bella's savings is \$1749, how much does Charlie have?

Answer : \$ _____

29. Write $\frac{27}{6}$ as a mixed number in its simplest form.

Answer : _____

30. $\frac{2}{3}$ of the girls in Primary 5G wear spectacles. If 10 girls wear spectacles, how many girls are there in Primary 5G?

Answer : _____

- 31.

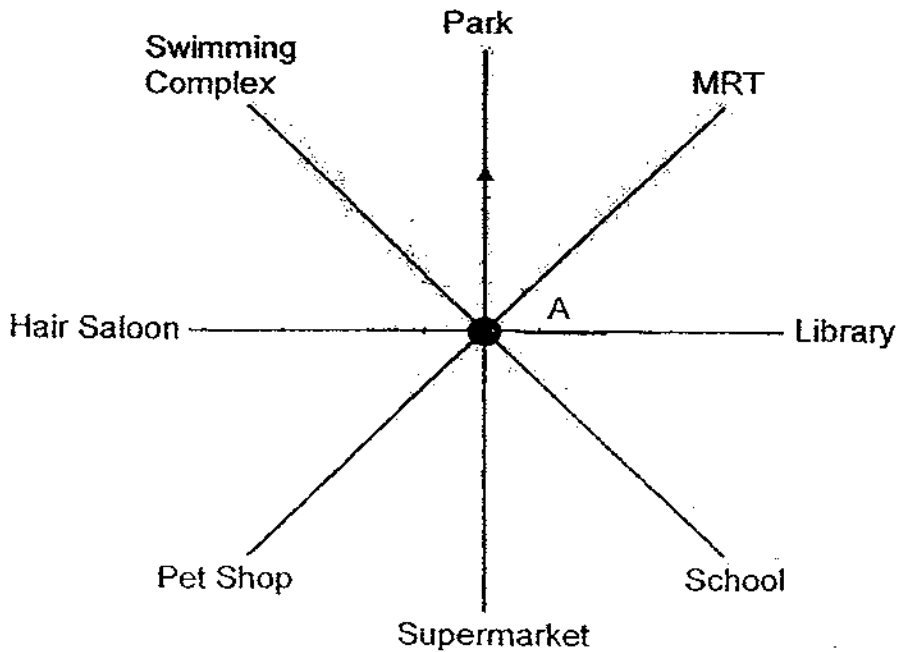

- Alison is standing at the point marked A . She is facing the park.
 (a) State the direction she needs to turn to face the pet shop.
 (b) How many quarter turns does she need to make in (a)?

Answer : (a)

(b) _____

32. What is the sum of the smallest and the greatest fractions in the box shown below? (Leave your answer in its simplest form.)

| | | | | | | |
|---------------|---|----------------|---|---------------|---|---------------|
| $\frac{1}{4}$ | , | $\frac{7}{12}$ | , | $\frac{2}{3}$ | , | $\frac{1}{6}$ |
|---------------|---|----------------|---|---------------|---|---------------|

Answer : _____

33. Mrs Lim bought 13 kg of mangosteens at \$2.50 per kg. How much did she pay for the mangosteens? Round off your answer to the nearest dollar.

Answer : \$ _____

34. The pattern below shows part of a tessellation. Extend the tessellation by drawing 4 more of the unit shape.

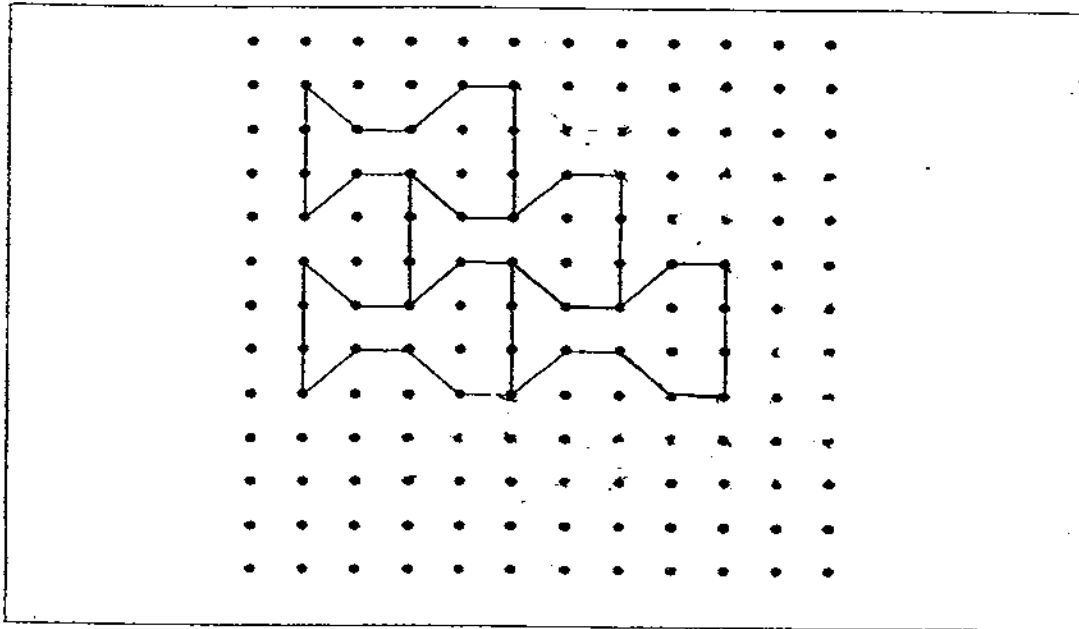

35. The perimeter of a rectangular plot of land is 72 m. Its length is twice its breadth. What is the area of the plot of land?

Answer : _____ m²

36. What is the value of $89.03 - 49.1$?

Answer : _____

37. The mass of a parcel, when rounded off to the nearest hundredth, is 36.86 kg. What is the smallest possible mass of the parcel?

Answer : _____ kg

38. The total length of 6 identical pieces of rope and 4 identical pieces of wire is 25.3 m. The total length of 1 piece of rope and 1 piece of wire is 5 m. What is the total length of 3 pieces of rope?

Answer : _____ m

39. The figure below shows part of a symmetrical figure. Shade 8 more squares to complete the figure so that the dotted line XY is the line of symmetry.

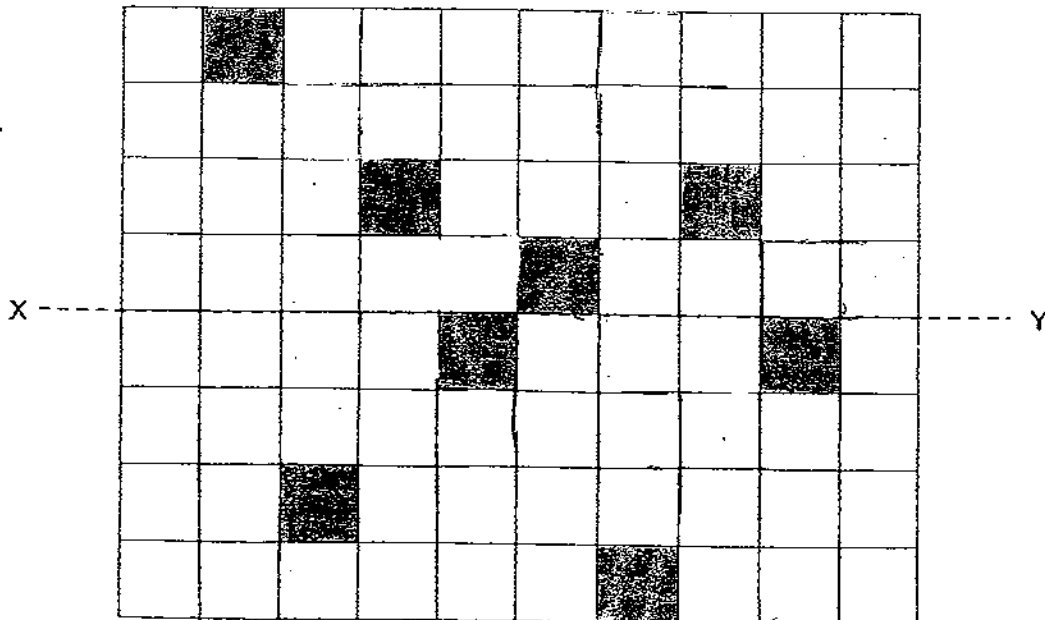

40. The diagram below shows a tile.

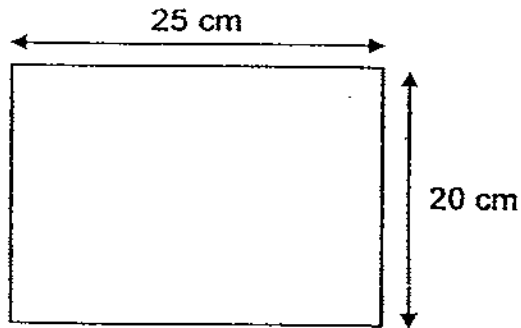

How many such tiles are needed to lay the floor of a room measuring 4 m by 5 m?

Answer : _____

Section C

Questions 41 to 45 carry 4 marks each. Do these word problems carefully. Show your working clearly in the space provided for each question and write your answers in the spaces provided.

(Total: 20 marks)

41. There are 1600 books in a library. $\frac{5}{8}$ of them are English books. The number of English books is twice that of Chinese books. The rest of them are Malay books.

- (a) How many Malay books are there?
- (b) What fraction of the books are Chinese books?
(Leave your answer in its simplest form.)

Answer : (a) _____

(b) _____

42. The line graph below shows the number of cars sold in a showroom from February to August. Study it carefully and answer the following questions.

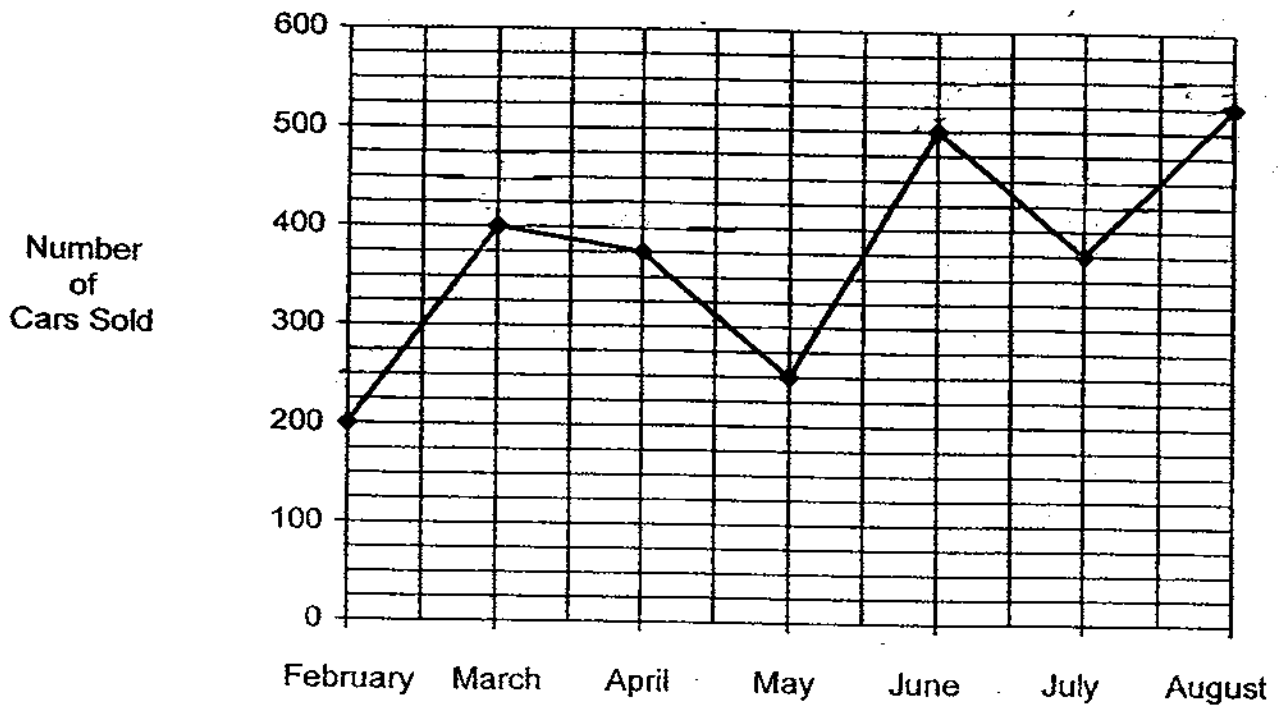

- What was the total number of cars sold in March and April?
- Which period showed the greatest increase in sales?
- How much was the increase in (b)?

Answer : a) _____

b) From _____ to _____

c) _____

43. A pen cost \$0.20 and a notebook cost \$0.50.
Mary spent \$2.90 on some pens and notebooks.
If she bought 3 more notebooks than pens, how many pens did she buy?

Answer : _____

44. The time in Singapore is 6 hours ahead of that of France. The Tan family took a flight from Singapore to France at 23 45 in Singapore time on 2nd July 2009. They arrived in France at 08 00 in France time on 3rd of July 2009. How long was the flight duration?

Answer : _____

45. Mrs Tan is distributing flowers to a group of pupils during a floral arrangement lesson. If she gives each pupil 3 flowers, she will have 9 flowers left. If she gives each pupil 4 flowers, she will have 2 flowers left.
- a) How many flowers are distributed to the group of pupils given that Mrs Tan has less than 35 flowers?
 - b) How many pupils are there in the group?

Answer : a) _____

b) _____

END OF PAPER

Please check your work carefully!

Setters: Mrs Eliza Tang
Mdm Jessica Ong



ANSWER SHEET

EXAM PAPER 2009

SCHOOL : NANYANG PRIMARY
SUBJECT : PRIMARY 4 MATHEMATICS

TERM : SA2

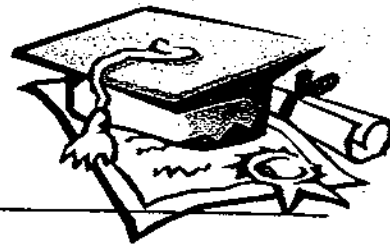

| | | | | | | | | | | | | | | | | |
|----|----|----|----|----|----|----|----|----|-----|-----|-----|-----|-----|-----|-----|-----|
| Q1 | Q2 | Q3 | Q4 | Q5 | Q6 | Q7 | Q8 | Q9 | Q10 | Q11 | Q12 | Q13 | Q14 | Q15 | Q16 | Q17 |
| 2 | 4 | 1 | 2 | 2 | 2 | 3 | 1 | 3 | 3 | 3 | 3 | 2 | 3 | 4 | 2 | 4 |

| | | |
|-----|-----|-----|
| Q18 | Q19 | Q20 |
| 2 | 3 | 3 |

- 21)1340 22)15 23)45 24)85° 25)0.08 26)18
- 27)24 28)\$253 29)4½ 30)15 31)a)South West b)1½

- 32)5/6 33)\$33 34)

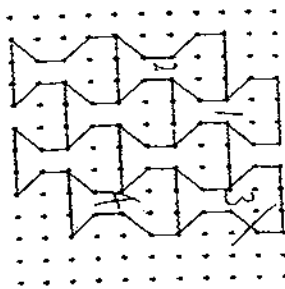

- 35)288m²

- 36)39.93 37)36.855kg

- 38)7.95m

- 39)

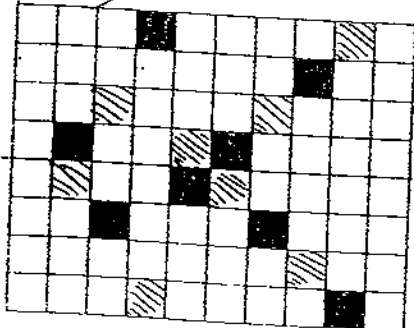

40)400 tiles

**41)a)100
b)5/16**

**42)a)775
b)May to June
c)250**

43)2

44)14h 15 min

**45)a)30
b)7**