

SINGAPORE CHINESE GIRLS' SCHOOL (PRIMARY)
SECOND SEMESTRAL ASSESSMENT 2011
PRIMARY 4
MATHEMATICS

Name: _____ ()

Marks:

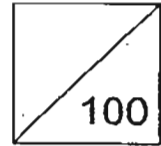

Class: Primary 4

Time: 1 h 45 min

Parent's Signature: _____

Section A: (30 marks)

Questions 1 to 15 carry 2 marks each. For each question, four options are given. One of them is the correct answer. Make your choice (1, 2, 3 or 4). Shade the correct oval (1, 2, 3 or 4) on the Optical Answer Sheet.

1. The value of the digit 7 in 71 345 is _____.

- (1) 70
- (2) 700
- (3) 7000
- (4) 70 000

2. 98 thousands and 6 tens is the same as _____.

- (1) 986
- (2) 9860
- (3) 98 006
- (4) 98 060

3. How many quarters are there in 3 wholes?

- (1) $\frac{1}{3}$
- (2) $\frac{3}{4}$
- (3) 4
- (4) 12

4. $7.02 = 7 + \frac{2}{\square}$

- (1) 1
- (2) 10
- (3) 100
- (4) 1000

5. Which of the following decimals is the greatest?

- (1) 0.361
- (2) 0.354
- (3) 0.057
- (4) 0.198

6. One of the lines in the figure is parallel to AB. Which line is parallel to AB?

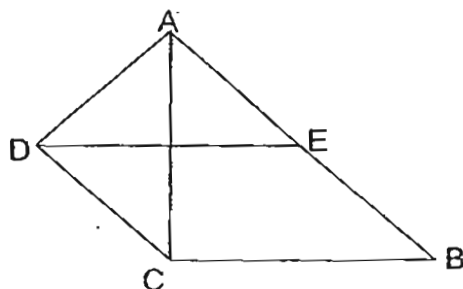

- (1) AD
- (2) BC
- (3) DC
- (4) DE

7. John has a piece of rope. It can be divided into pieces of length 3 cm, 6 cm or 9 cm with no remainder. What is the shortest length of rope that John has?

- (1) 27 cm
- (2) 30 cm
- (3) 36 cm
- (4) 42 cm

8. John spent $\frac{1}{5}$ of his money on books and $\frac{3}{10}$ of his money on pencils. What fraction of his money did he spend?

(1) $\frac{4}{5}$

(2) $\frac{1}{2}$

(3) $\frac{4}{15}$

(4) $\frac{3}{50}$

9. John is 1.6 m tall. He is taller than Meiling by 0.22 m. How tall is Meiling?

(1) 1.38 m

(2) 1.42 m

(3) 1.78 m

(4) 1.82 m

10. Peter bought a plant that grew 0.5 cm every day. When he bought the plant, it was 1 m tall. How tall would the plant be exactly 8 days later?

(1) 1.004 m

(2) 1.04 m

(3) 1.4 m

(4) 14 m

11. Look at the clocks below. Tom watched a movie. How long was the movie?



Start of movie



End of movie

- (1) 1 h 25 min
- (2) 1 h 35 min
- (3) 2 h 25 min
- (4) 2 h 35 min

12. The table below shows part of the menu at a bubble tea shop.

Item	Small Cup	Large Cup
Milk tea	\$2.50	\$3.50
Green tea	\$2.00	\$2.80

Bala wanted to buy 1 small cup of green tea and 1 large cup of milk tea.

How much more money would he need if he had only six 50-cent coins in his wallet?

- (1) \$2.50
- (2) \$3.50
- (3) \$5.20
- (4) \$8.50

13. Look at the picture below. Ali is now facing the shops. Where will Ali be facing if he makes a 135° clockwise turn?

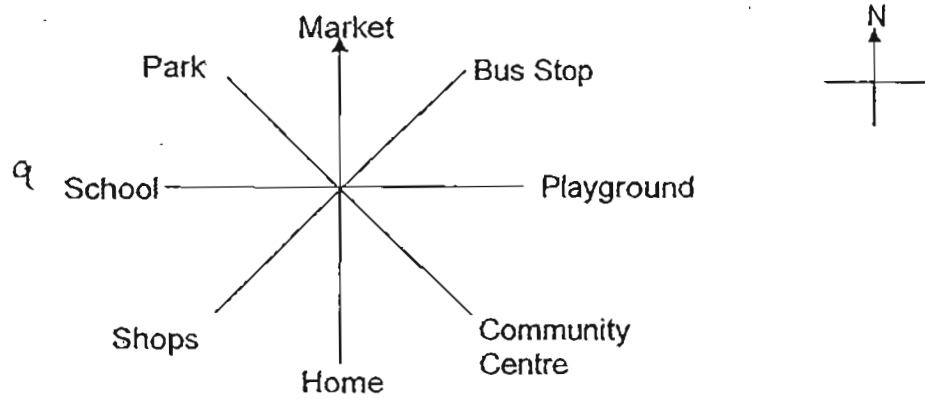

- (1) Home
 (2) Playground
 (3) Market
 (4) Bus Stop
14. The figure below is not drawn to scale. XY is a straight line. Find the value of $\angle p$.

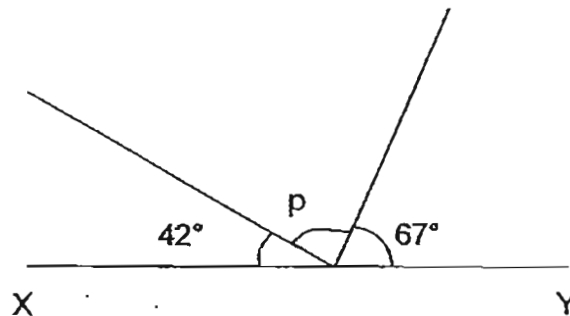

- (1) 23°
 (2) 71°
 (3) 109°
 (4) 138°

15. Which of the following shapes can tessellate?

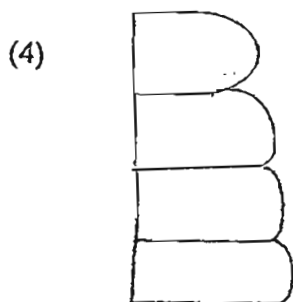
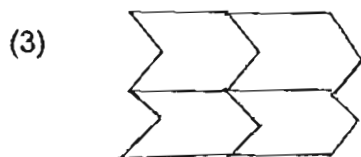

Name _____ ()

Class: Primary 4

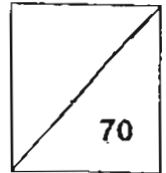

Section B: (40 marks)

Questions 16 to 35 carry 2 marks each. Write your answers in the spaces provided. For questions which require units, give your answers in the units stated.

Do not write
in this column

16. Arrange the numbers from the greatest to the smallest.

378, 837, 873, 387

Ans: _____ , _____ , _____ , _____
(greatest) (smallest)

17. Round off 92 561 to the nearest hundred.

Ans: _____

18. Which two of the fractions below are smaller than $\frac{1}{2}$?

$\frac{2}{5}$, $\frac{3}{7}$, $\frac{5}{6}$, $\frac{6}{11}$

Ans: _____ and _____

19. $1\frac{1}{4} + \frac{3}{8} =$ _____

Ans: _____

20. Find the value of $1 - \frac{1}{3} - \frac{4}{9}$.

Ans: _____

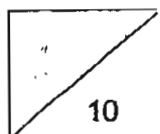

21. Write the decimal represented by A.

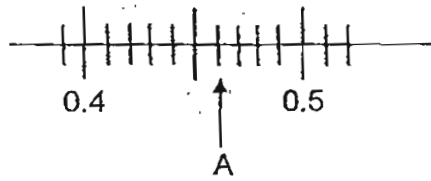

Ans: _____

22. Express 0.6 as a fraction.

Ans: _____

23. Round off 15.53 to the nearest whole number.

Ans: _____

24. In the figure below, ABCD is a rectangle. Find the value of $\angle x$.

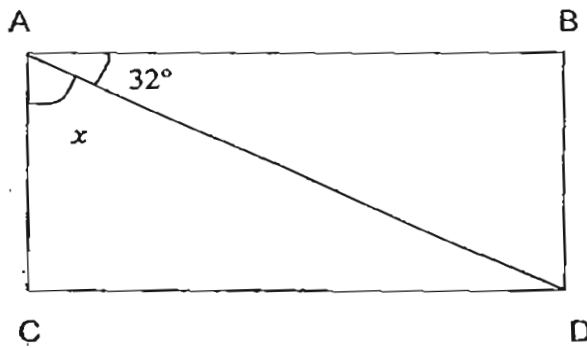

Ans: _____

25.

$$\square + \square = \frac{4}{5}$$

$$\square + \bigcirc = \frac{9}{10}$$

$$\bigcirc + \diamond = \frac{3}{5}$$

Ans: _____

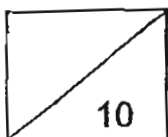

26. The mass of a mango is $\frac{1}{4}$ kg. The total mass of the mango and a durian is $4\frac{2}{3}$ kg. Find the mass of the durian.

Ans: _____ kg

27. The length of ribbon A is 10.08 m. It is 3 times as long as ribbon B. Find the length of ribbon B.

Ans: _____ m

28. The capacity of a jug is 0.75 l of juice. Joe filled 8 such jugs completely with juice and still had 0.5 l of juice left over. How much juice did he have at first?

Ans: _____ l

29. Mr Li used 2.5 kg of rice on Monday and 1.75 kg more on Tuesday. He used a total of 9 kg from Monday to Wednesday. How much rice did he use on Wednesday?

Ans: _____ kg

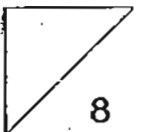

30. ABCD is a rectangle. Draw a line (label it FG) that is parallel to BE such that FG cuts AD and BC.

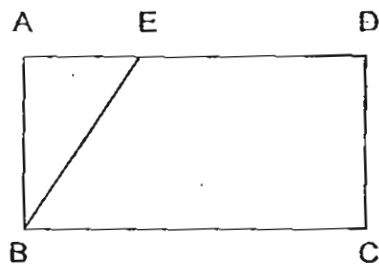

31. Complete the symmetric figure with the line AB as the line of symmetry.

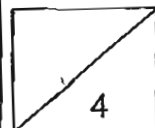
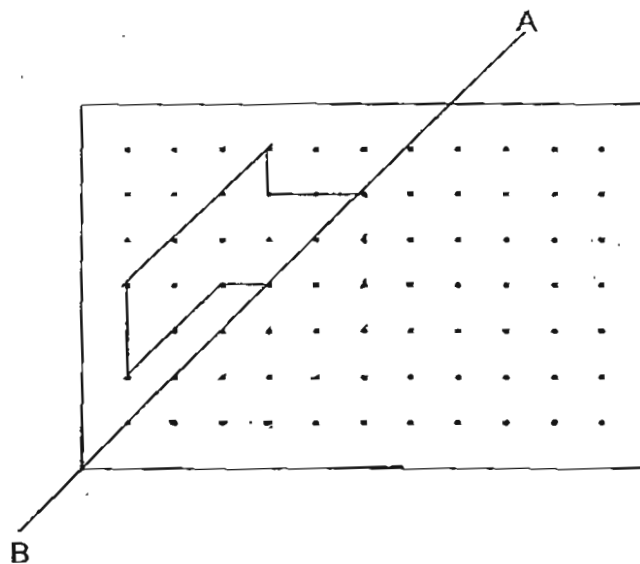

32. The pattern in the box shows part of a tessellation.
 Draw 2 unit shapes in the given grid below to extend the tessellation.
 (2 marks)

Do not write
 in this column

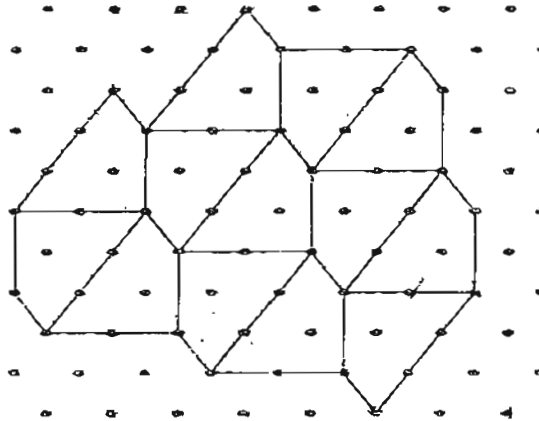

33. The graph below shows the number of pets each child has in a class.

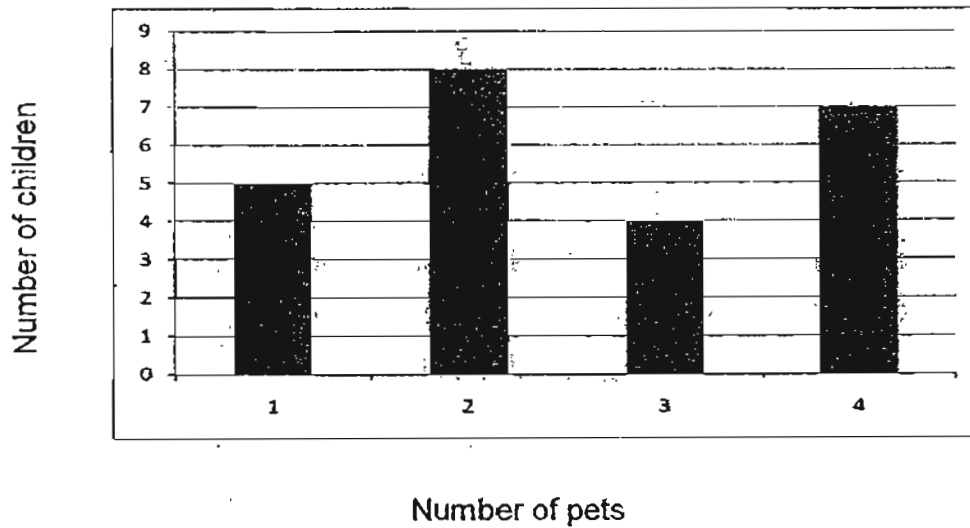

How many pets do the children have?

Ans: _____

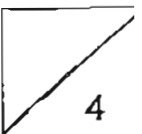

34. The line graph below shows the distance Tom jogged for a particular week.

Do not write
in this column

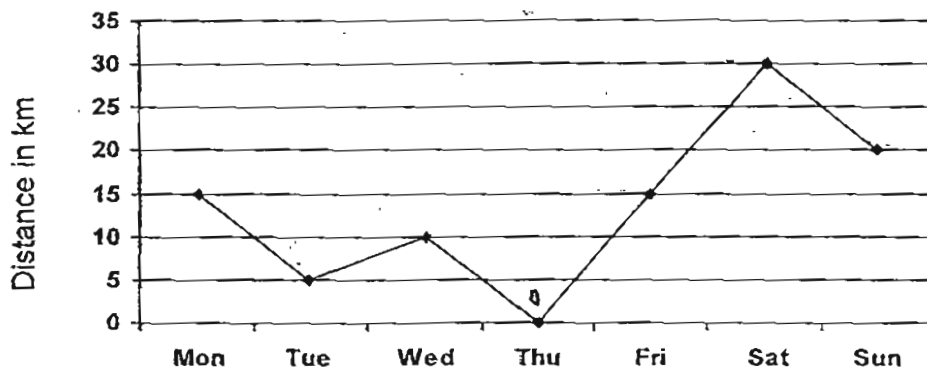

On which day of the week did Tom jog more than 15 km but less than 30 km?

Ans: _____

35. A piece of wire 2 m 48 cm long was cut into 2 pieces. The first piece was used to make a rectangle as shown below. The second piece was used to make a square. Find the length of the square.

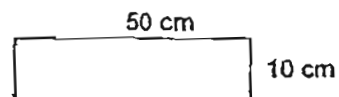

Ans: _____ cm

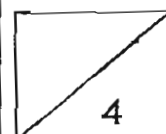

Name : _____ ()

Do not write
in this column

Class: Primary 4

Section C: (30 marks)

For each questions 36 to 43, show your workings clearly in the space provided for each question and write your answers in the spaces provided.

The number of marks available is shown in brackets [] at the end of each question or part-question.

36. The table below shows the amount of money 4 children spend in a week.

Name	Amount of money
Ali	\$18.50
Kelly	?
Stella	\$14.00
Mike	?

Kelly spent \$2 more than Mike. The total amount of money spent by the 4 children was \$50. How much did Mike spend?

Ans: _____ [3]

37. Jim had 5 times as much money as Daniel. After Daniel was given \$30, he had half as much as Jim. How much did Jim have?

Ans: _____ [3]

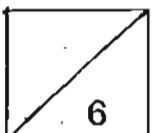

38. There were 3000 people at a concert. There were 1500 women and this was 3 times the number of men there. How many children were at the concert?

Do not write
in this column

Ans: _____ [3]

39. The figure below is formed by 2 squares and the perimeter of the small square is 36 cm. The area of the shaded part is 88 cm^2 . Find the area of the big square.

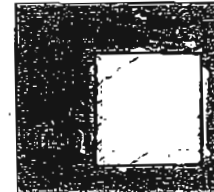

Ans: _____ [3]

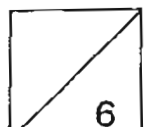

40. Mr Loh had 234 apples. He sold $\frac{4}{9}$ of them and gave the rest to be shared equally between his 2 children. How many apples did each child get?

Do not write
in this column

Ans: _____ [4]

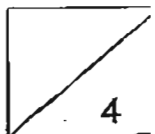

41. Megan had \$180 to spend on cookies. The prices of cookies are listed below.

Do not write
in this column

Number of boxes of cookies	Price
1	\$10
5	\$40

What is the maximum number of boxes of cookies she could buy with \$180?

Ans: _____ [4]

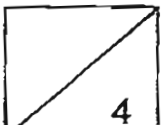

42. Keith, Mindy, Sharon and Carl were nominated in an election. Keith got twice as many votes as Mindy. Sharon got 15 more votes than Carl. Carl got half as many votes as Mindy but 30 fewer votes than Keith. How many people were involved in the voting if everyone was given one vote?

Do not write
in this column

Ans: _____ [5]

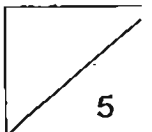

43. The figures below are not drawn to scale.

The perimeter of Rectangle T is 28 cm. The area of Square R is 3 times the area of Rectangle T. Find the area of Square R

Do not write
in this column

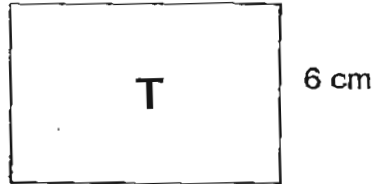
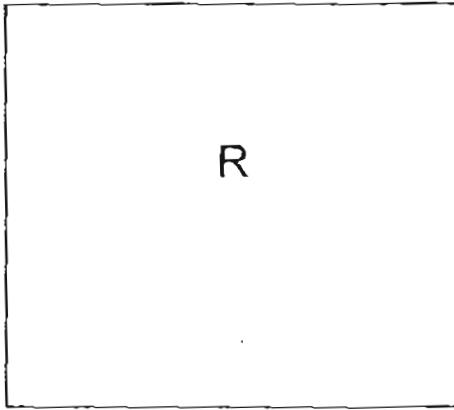

Ans : _____ [5]

END OF PAPER

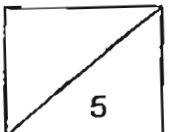



ANSWER SHEET

EXAM PAPER 2011

**SCHOOL : SCGS
SUBJECT : PRIMARY 4 MATHEMATICS**

TERM : SA2



Q1	Q2	Q3	Q4	Q5	Q6	Q7	Q8	Q9	Q10	Q11	Q12	Q13	Q14	Q15
4	4	4	3	1	3	3	2	1	3	2	1	3	2	3

16) 873, 837, 387, 378

17) 92600

18) $2/5, 3/7$

19) $15/8$

20) $2/9$

21) 0.46

22) $3/5$

23) 16

24) 58°

25) $\diamond = 1/10$

26) $45/12\text{kg}$

27) 3.36m

28) 6.5

29) 2.25kg

30)

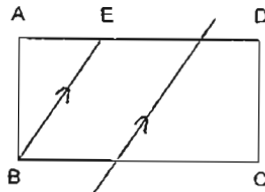

31)

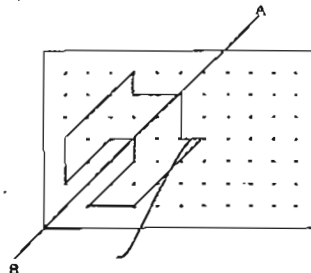

32)

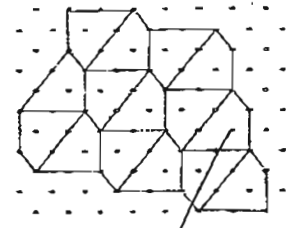

33) 61

34) Sunday

35) 32cm

36) $A+S \rightarrow \$18.50 + \$14.00 = \$32.50$

$K+M \rightarrow \$50.00 - \$32.50 = \$17.50$

$\$17.50 - \$2 = \$15.50$

$\$15.50 \div 2 = \7.75

37) $10 \div 2 = 5$

$3u \rightarrow \$30$

$1u \rightarrow \$30 \div 3 = \10

$J \rightarrow 10u$

$10u \rightarrow \$10 \times 10 = \100

38) $3u \rightarrow 1500$

$1u \rightarrow 1500 \div 3 = 500$

$M \rightarrow 500$

$W+M \rightarrow 500 + 1500 = 2000$

$C \rightarrow 3000 - 2000 = 1000$

39) $36\text{cm} \div 4 = 9\text{cm}$

Area of small square = $9\text{cm} \times 9\text{cm} = 81\text{cm}^2$

$81\text{cm}^2 + 88\text{cm}^2 = 169\text{cm}^2$

40) $9u \rightarrow 234$ apples

$1u \rightarrow 234 \text{ apples} \div 9 = 26$

Sold $\rightarrow 26 \times 4 = 104$

Left $\rightarrow 234 - 104 = 130$

$5u \rightarrow 130$

2 children $\rightarrow 130$

1 child $\rightarrow 130 \div 2 = 65$

41) $1 \rightarrow \$180 \div \$10 = 18$

$5 \rightarrow \$180 \div \$40 = 4r20$

$\rightarrow \$20 \div 10 = 2$

} $20 + 2 = 22$

$5 \rightarrow \$180 \div (\$10 + \$40)$

$= \$180 \div \50

$= 3r30$

$1 \rightarrow \$30 \div \$10 = 3$

} $18 + 3 = 21$

Ans: 22

42) $3u \rightarrow 30$

$1u \rightarrow 30 \div 3 = 10$

K $\rightarrow 10 \times 4 = 40$

M $\rightarrow 10 \times 2 = 20$

C $\rightarrow 20 \div 2 = 10$

S $\rightarrow 10 + 15 = 25$

$40 + 20 + 10 = 70$

$70 + 25 = 95$

43) Rectangle T

Breadth $\rightarrow 6\text{cm}$

2 breadth $\rightarrow 6\text{cm} \times 2 = 12\text{cm}$

$28\text{cm} - 12\text{cm} = 16\text{cm}$

1 Length $\rightarrow 16\text{cm} \div 2 = 8\text{cm}$

Area $\rightarrow 8\text{cm} \times 6\text{cm} = 48\text{cm}^2$

Square R

Area : $48\text{cm}^2 \times 3 = 144\text{cm}^2$