

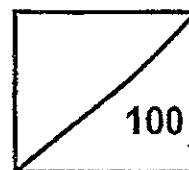

**Rosyth School**  
**Second Semestral Assessment 2014**  
**Mathematics**  
**Primary 4**

Total



Name: \_\_\_\_\_

Class: Pr 4-\_\_\_\_\_ Register No. \_\_\_\_\_

Duration: 1h 45 min

Date: 13<sup>th</sup> Oct 2014

Parent's Signature: \_\_\_\_\_

---

**Instructions to Pupils:**

1. Do not open this booklet until you are told to do so.
2. Follow all instructions carefully.
3. This paper consists of 3 parts, Sections A, B and C.
4. For questions 1 to 20 in Section A, shade the correct ovals on the Optical Answer Sheet (OAS).
5. ANSWER ALL THE QUESTIONS.

|                  | <b>Maximum</b> | <b>Marks Obtained</b> |
|------------------|----------------|-----------------------|
| <b>Section A</b> | <b>40</b>      |                       |
| <b>Section B</b> | <b>40</b>      |                       |
| <b>Section C</b> | <b>20</b>      |                       |
| <b>Total</b>     | <b>100</b>     |                       |

This paper consists of 20 pages altogether (including the cover page).

This paper is not to be reproduced in part or whole without the permission of the Principal.

**Section A (40 marks)**

For questions 1 to 20, four options are given. One of them is the correct answer. Make your choice (1, 2, 3 or 4). Shade the correct ovals (1, 2, 3 or 4) onto the Optical Answer Sheet provided. Each question carries 2 marks.

---

1. In which of the following numbers is the digit 8 in the thousands place?

- (1) 5 780
- (2) 5 870
- (3) 7 850
- (4) 8 507

2. In which of the following are the numbers arranged from smallest to the greatest?

- |     | (smallest) |        | (greatest) |
|-----|------------|--------|------------|
| (1) | 9 793,     | 9 379, | 9 937      |
| (2) | 9 397,     | 9 973, | 9 739      |
| (3) | 9 397,     | 9 739, | 9 973      |
| (4) | 9 973,     | 9 739, | 9 397      |

3. Complete the following number pattern.

17, 25, 33, \_\_\_\_\_, \_\_\_\_\_, 57

- (1) 34, 35
- (2) 34, 56
- (3) 41, 49
- (4) 55, 56

4. How many one-fifths are there in 3 wholes?

- (1) 5
- (2) 8
- (3) 15
- (4) 35

5. What fraction of the shapes in the box are ?

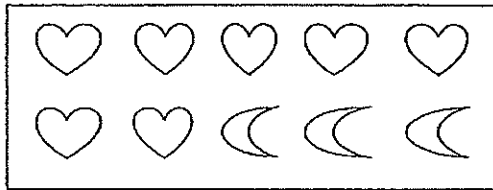

- (1)  $\frac{3}{10}$
- (2)  $\frac{7}{10}$
- (3)  $\frac{3}{7}$
- (4)  $\frac{7}{3}$

6. The digit 8 in 76.182 stands for 8 \_\_\_\_\_.

- (1) tens
- (2) hundreds
- (3) tenths
- (4) hundredths

7. A group of students went to the Singapore Maritime Museum.  $\frac{3}{5}$  of them were boys. There were 45 boys. How many students were girls?

- (1) 15
- (2) 18
- (3) 30
- (4) 75

8. There are 2 similar beakers below. How much more water is needed to fill both beakers to the 1 litre mark?

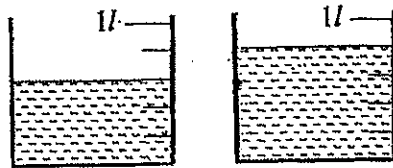

- (1)  $\frac{1}{5} l$
  - (2)  $\frac{3}{5} l$
  - (3)  $\frac{4}{5} l$
  - (4)  $1\frac{2}{5} l$
9. Find the difference between 20 hundredths and 15 tenths.
- (1) 0.05
  - (2) 1.30
  - (3) 1.48
  - (4) 5.00

10. The figure below is not drawn to scale.  $\angle PQR$  is a right angle.  $\angle a$  is equal to  $\angle b$ . Find the value of  $\angle b$ .

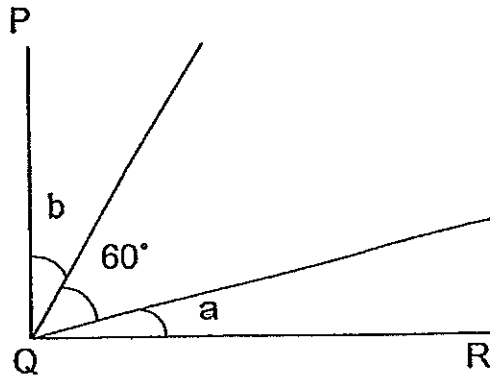

- (1)  $15^\circ$   
(2)  $30^\circ$   
(3)  $60^\circ$   
(4)  $120^\circ$
11. How many angles in the figure below are smaller than a right angle?

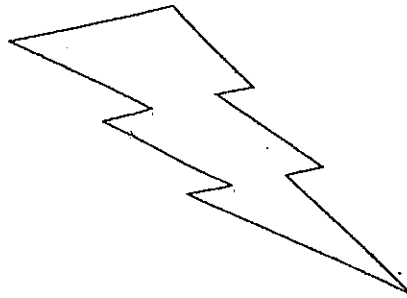

- (1) 1  
(2) 5  
(3) 6  
(4) 11
12. Find the sum of  $9\frac{3}{100}$  and  $5\frac{1}{100}$ .
- (1) 14.04  
(2) 14.13  
(3) 14.31  
(4) 14.4

13. All the lines drawn on the square grid below are straight lines.

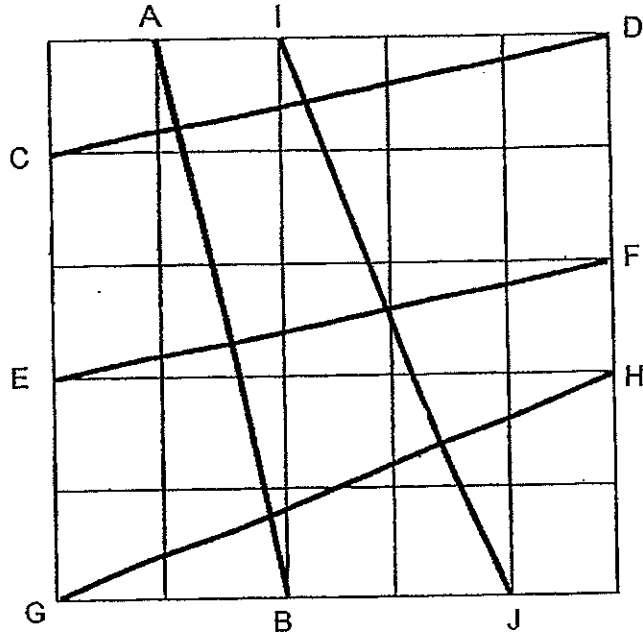

Name a pair of parallel lines.

- (1)  $CD \parallel EF$   
 (2)  $CD \parallel GH$   
 (3)  $AB \parallel EF$   
 (4)  $GH \parallel IJ$
14. When Peter finished his evening run, the time was as shown on the clock below. If he took 35 minutes to run, at what time did he start his run?  
 (Express your answer using the 24-hour clock)

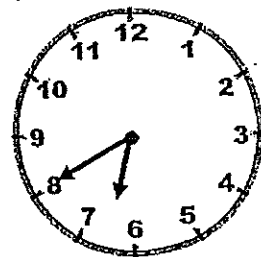

- (1) 0605  
 (2) 0715  
 (3) 1805  
 (4) 1915

Use the information below and answer questions 15 and 16.

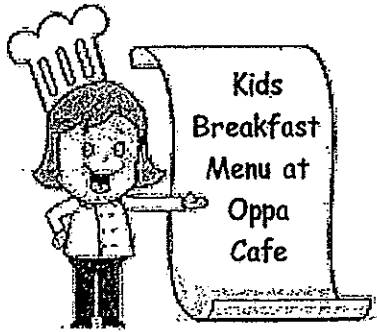

|                               |        |
|-------------------------------|--------|
| Mini Eggs and Cheese Sandwich | \$4.95 |
| Mini Nutella Sandwich         | \$3.45 |
| Plain Pancake                 | \$3.95 |
| Double Chocolate Pancake      | \$4.95 |
| Mini Fruit Salad              | \$4.50 |

15. Mrs Peak bought 2 Mini Nutella Sandwiches and a Mini Fruit Salad. How much did she pay altogether?

- (1) \$7.95
- (2) \$11.40
- (3) \$12.45
- (4) \$15.90

16. Mr Yeo wanted to buy 4 Double Chocolate Pancakes but he only had \$8. How much more money did he need?

- (1) \$11.80
- (2) \$12.95
- (3) \$19.80
- (4) \$27.80

17. The figure below is formed by five 3-cm squares. Find the total area of the figure.

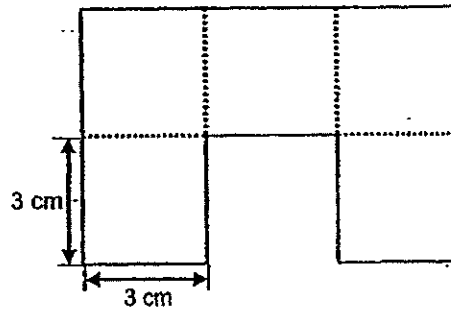

- (1)  $15 \text{ cm}^2$   
(2)  $36 \text{ cm}^2$   
(3)  $45 \text{ cm}^2$   
(4)  $60 \text{ cm}^2$
18. Tank A contains 24.99 l of water while Tank B contains 7 times as much water as Tank A. Find the total volume of water in both tanks.
- (1) 3.57 l  
(2) 28.56 l  
(3) 174.93 l  
(4) 199.92 l
19. Aisha bought a pack of sugar. She used  $\frac{1}{2}$  of it to make a cake and  $\frac{1}{4}$  of it to make muffins. If she had 750 g of sugar left, how much sugar did she buy at first?
- (1) 1 kg  
(2) 2 kg  
(3) 3 kg  
(4) 1.5 kg



20.

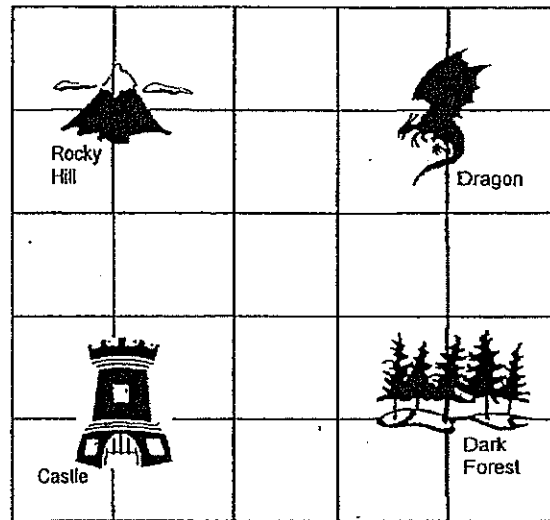

4 students looked at the map above and made the following statements.  
Bala said, "The Castle is North of the Rocky Hill."  
Caile said, "The Dark Forest is South of the Dragon."  
Donovan said, "The Dragon is Southwest of the Castle."  
Elena said, "The Rocky Hill is East of the Dragon."

Who made the correct statement?

- (1) Bala
- (2) Caile
- (3) Donovan
- (4) Elena

**Section B (40 marks)**

For questions 21 to 40, show your working clearly in the space below each question and write your answer in the answer boxes provided. Give your answers in the units stated. Each question carries 2 marks.

---

21. Some factors of 18 are 1, 2, 9 and 18. What are the other two factors of 18?

22. Round off 72 852 to the nearest hundred.

23. Find the value of  $1 - \frac{1}{4} - \frac{3}{8}$ .

24. Express  $\frac{27}{6}$  as a mixed number in its simplest form.

25. Which two of the fractions below are in the simplest form?

26. In the figure, ABCD is a rectangle. Find the value of  $\angle X$ .

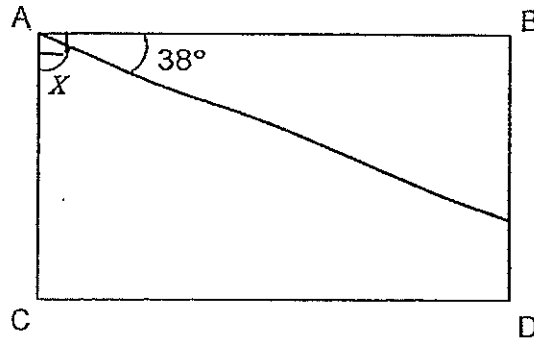



27. Arrange the following numbers from the greatest to the smallest.

$$0.085, \frac{4}{5}, 0.805$$

|                   |       |                   |
|-------------------|-------|-------------------|
| _____             | _____ | _____             |
| <i>(greatest)</i> | ,     | <i>(smallest)</i> |

28. Express 0.09 as a fraction in its simplest form.

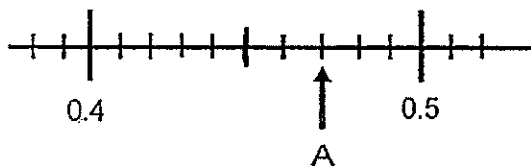
29. Write the decimal represented by A.



Use the following information below to answer questions 30 and 31.

The graph shows Sam's mass from 2010 to 2014.

**Sam's mass (kg) from 2010 to 2014**

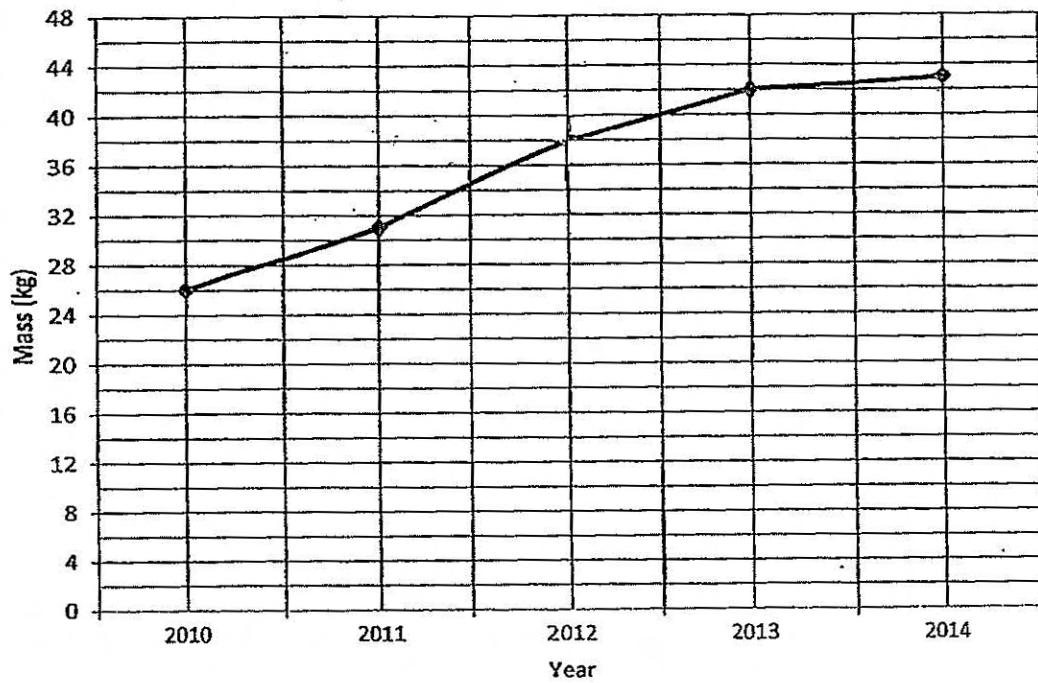

30. During which 1-year period was the increase in his mass the greatest?

Between Year \_\_\_\_\_ and \_\_\_\_\_

31. What was Sam's increase in mass from 2012 to 2014?

\_\_\_\_\_ kg

32. I am greater than 43 but smaller than 44.

The digit 9 stands for  $\frac{9}{1000}$ .

I have a digit 2 in the tenths place.

The value of the digit 8 is 0.08.

What number am I?

33. Javier and Kumar shared some cards. Javier took  $\frac{5}{11}$  of the cards while Kumar took the rest. If Kumar took 9 more cards than Javier, How many cards were there at first?

34. The figures below are not drawn to scale. Rectangle WXYZ has the same area as square CDEF. Find the perimeter of square CDEF.

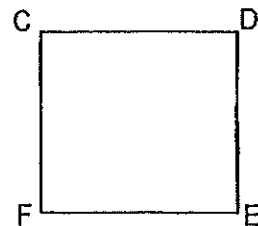
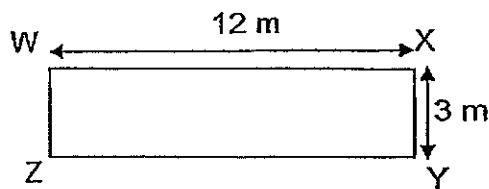

35. Randy bought 9 similar keychains. He gave the cashier \$50 and received a change of \$18.95. What was the cost of 1 keychain?

36. The total mass of a basket containing 5 bars of chocolate was 700.54 g. When 3 more bars of chocolate were placed in the basket, the total mass increased by 308.7 g. What is the mass of the empty basket?

37.

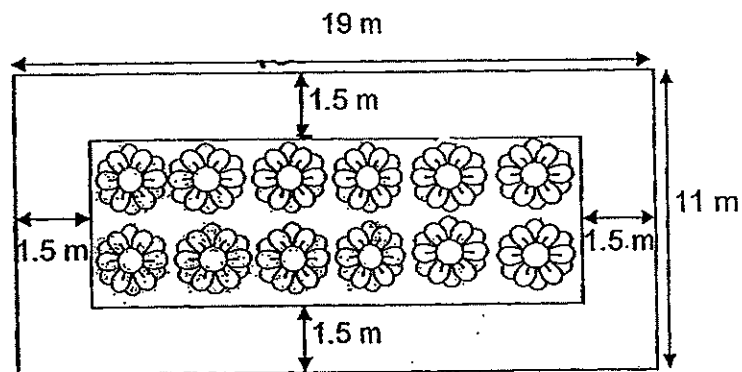

A rectangular flower bed is surrounded by a 1.5 m wide path as shown above. What is the perimeter of the flower bed?

38. When it is 15 00 in London, it is 22 00 in Singapore on the same day.  
Cassandra made a call to her mother from Singapore at 13 00 to London.  
What time was it in London when she made the call?  
(Express your answer using the 12-hour clock)

39. Mrs Lee used  $5\frac{3}{8}$  kg of flour to make a cake.  
She used  $1\frac{1}{4}$  kg of flour less to make pancakes than a cake.  
How much flour did she use in total?  
(Express your answer in the simplest form)

 kg

40. Davi shared 108 m of string equally with Amanda, Claris and Siti. If Claris gave half of her share to Siti, how much string did Siti have?

 m

**Section C (20 marks)**

For questions 41 to 45, show your working clearly in the space below each question and write your answers in the blanks provided. The marks for each question or part question are given in the brackets.

41. During the National Day Parade, there were 26 957 spectators watching the parade. There were twice as many children as women. There were twice as many women as men. How many children were at the National Day Parade?

Answer: \_\_\_\_\_ [4]



42. The figure below is made up of rectangle A, rectangle B and square C.  
The length of square C is 8 cm.

Area of square C is  $\frac{1}{2}$  the area of rectangle B.

Area of rectangle A is thrice the area of rectangle B.

What is the area of the whole figure?

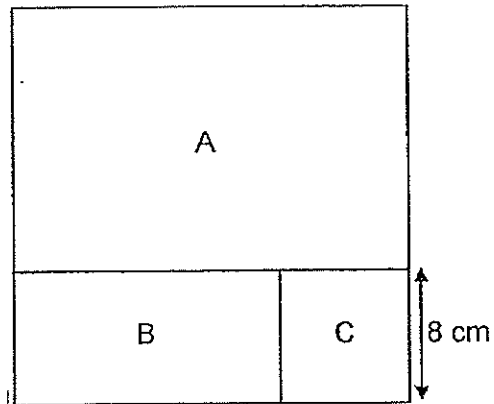

Answer: \_\_\_\_\_ [4]

43. At a fruit stall, a bag of mangoes cost \$5 and a bag of pears cost \$3. Iman bought 25 bags of fruits and paid \$93. How many bags of mangoes did he buy?

Answer: \_\_\_\_\_ [4]

44. Container A and Container B had 50.36 litre of water. After 9.05 litre of water was transferred from Container A to B, Container A had thrice as much water as Container B. How much water was in Container A at first?  
(Round off your answer to 1 decimal place)

Answer: \_\_\_\_\_ [4]

45. Farah had a bag of rice. She prepared an equal amount of rice each day to sell at her Nasi Lemak stall. At the end of 3 days, she had  $\frac{4}{5}$  of her bag of rice left. At the end of 9 days, she had 36 kg of rice left. How much rice did she use in 7 days?

Answer: \_\_\_\_\_ [4]

**~END OF PAPER~**

*Have you checked your work thoroughly?*

**Year: 2014**

**Level: Primary 4**

**School: Rosyth School**

**Subject: Mathematics**

**Semester: SA2**

**Section A:**

|     |     |     |     |     |     |     |     |     |     |
|-----|-----|-----|-----|-----|-----|-----|-----|-----|-----|
| Q1  | Q2  | Q3  | Q4  | Q5  | Q6  | Q7  | Q8  | Q9  | Q10 |
| 4   | 3   | 3   | 3   | 1   | 4   | 3   | 2   | 2   | 1   |
| Q11 | Q12 | Q13 | Q14 | Q15 | Q16 | Q17 | Q18 | Q19 | Q20 |
| 3   | 1   | 1   | 3   | 2   | 1   | 3   | 4   | 3   | 2   |

**Section B:**

Q21) 3 and 6

Q22) 72900

Q23)  $\frac{3}{8}$

Q24)  $4\frac{1}{2}$

Q25)  $\frac{4}{7}$  and  $\frac{3}{8}$

Q26)  $52^\circ$

Q27) 0.805,  $\frac{4}{5}$ , 0.085

Q28)  $\frac{9}{100}$

Q29) 0.47

Q30) Between Year 2011 and 2012

Q31) 5 kg

Q32) 43.289

Q33) 99 cards

Q34) 24 m

Q35) \$3.45

Q36) 186.04 g

Q37) 48 m

Q38) 6.00 am

Q39)  $9 \frac{1}{2}$

Q40) 40.5 m

Section C

Q41) 3944

Q42)  $576 \text{ cm}^2$

Q43) 9 bags of mangoes

Q44) 46.8

Q45) 42 kg