



NAN HUA PRIMARY SCHOOL
SEMESTRAL ASSESSMENT 2 – 2017
PRIMARY FOUR
MATHEMATICS

INSTRUCTIONS TO CANDIDATES

1. Write your name, register number and class in the space provided.
 2. Do not turn over the page until you are told to do so.
 3. Follow all instructions carefully.
 4. Answer all questions.
 5. Shade your answers in the Optical Answer Sheet (OAS) provided for Questions 1 - 20.
-

Marks Obtained

Section	Maximum Marks	Actual Marks
A	40	
B	40	
C	20	
Total	100	

Name : _____ ()

Class : Pr 4 _____

Date : 30 October 2017

Duration: 1 h 45 min

Parent's Signature : _____

Section A: Multiple Choice Questions (20 × 2 marks)

Questions 1 to 20 carry 2 marks each.

Of the 4 options given, only one is correct. Choose the correct answer (1, 2, 3 or 4) and shade the correct oval on the Optical Answer Sheet (OAS).

1. In the number 67 890 which digit is in the tens place?

- (1) 6
- (2) 7
- (3) 8
- (4) 9

()

2. Which of the following numbers when rounded to the nearest ten becomes 94 500?

- (1) 94 444
- (2) 94 496
- (3) 94 506
- (4) 94 554

()

3. 6 and 9 are factors of _____

- (1) 12
- (2) 18
- (3) 27
- (4) 34

()

4. What is the quotient of 1 524 and 3?

- (1) 58
- (2) 508
- (3) 1 521
- (4) 4 572

()

5. Arrange the following fractions from the smallest to the greatest.

$$\frac{5}{9}, \quad \frac{1}{2}, \quad \frac{8}{9}$$

- | | <i>(smallest)</i> | <i>(greatest)</i> |
|-----|-------------------|----------------------------------|
| (1) | $\frac{1}{2},$ | $\frac{5}{9}, \quad \frac{8}{9}$ |
| (2) | $\frac{5}{9},$ | $\frac{1}{2}, \quad \frac{8}{9}$ |
| (3) | $\frac{8}{9},$ | $\frac{5}{9}, \quad \frac{1}{2}$ |
| (4) | $\frac{5}{9},$ | $\frac{8}{9}, \quad \frac{1}{2}$ |

()

6. Which of the following mixed numbers is represented by the letter A in the number line shown?

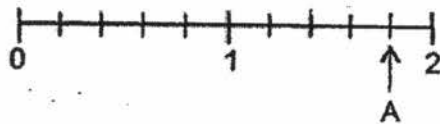

- (1) $1\frac{1}{5}$
 (2) $1\frac{4}{5}$
 (3) $2\frac{1}{5}$
 (4) $2\frac{4}{5}$

()

7. Which of the following fractions is not in its simplest form?

- (1) $\frac{2}{3}$
 (2) $\frac{3}{5}$
 (3) $\frac{4}{9}$
 (4) $\frac{5}{10}$

()

8. Joan had 8 bags of beads. There were 120 beads in each bag. She repacked all the beads into smaller bags consisting 6 beads each. How many smaller bags of beads did she have?

- (1) 15
- (2) 90
- (3) 160
- (4) 960

()

9. Express $\frac{7}{25}$ as a decimal.

- (1) 0.28
- (2) 0.35
- (3) 0.7
- (4) 0.725

()

10. In the figure below, which angle is smaller than a right angle?

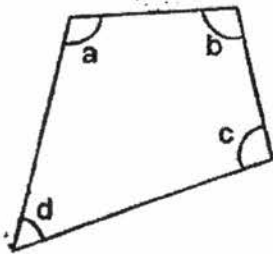

- (1) $\angle a$
- (2) $\angle b$
- (3) $\angle c$
- (4) $\angle d$

()

11. Jun Xin started his revision at 11 30. He completed his revision 1 h 35 min later. At what time did Jun Xin complete his revision?

- (1) 12 05
- (2) 13 05
- (3) 13 15
- (4) 14 05

()

12. Haslinda paid \$8.40 for 3 pens and 3 erasers. Each eraser cost 20¢ less than a pen. What was the cost of a pen?

- (1) \$1.20
- (2) \$1.30
- (3) \$1.40
- (4) \$1.50

()

13. Which of the following figures has more than 2 lines of symmetry?

(1)

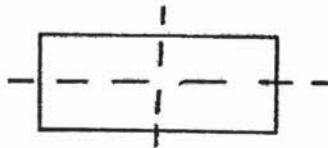

(2)

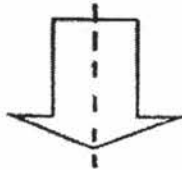

(3)

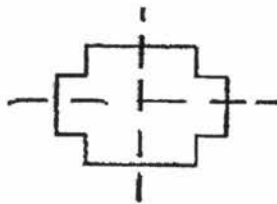

(4)

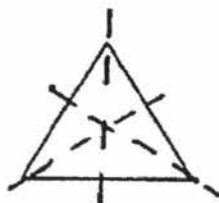

()

14. Arthur and Bala challenged each other to a race. Arthur took 70 s to complete the race and Bala reached the finishing line 12 s before Arthur. What was the total time taken by the two boys?

- (1) 1 min 28 s
- (2) 1 min 52 s
- (3) 2 min 8 s
- (4) 2 min 32 s

()

15. Adil and Samuel scored 2530 points in a game. Adil scored 62 points more than Samuel. How many points did Samuel score?

- (1) 1 234
- (2) 1 265
- (3) 1 296
- (4) 2 592

()

16. The table below shows the different modes of transport taken by the pupils in a primary school.

Modes of Transport	Number of boys	Number of girls
School Bus	267	320
Car	159	212
MRT Train	429	395

How many fewer pupils travel by school bus than by MRT train?

- (1) 19
- (2) 75
- (3) 162
- (4) 237

()

17. The figure below shows a square paper (not drawn to scale) with side 10 cm. Jack folded the paper into half and cut out a rectangular strip that measured 4 cm by 2 cm.

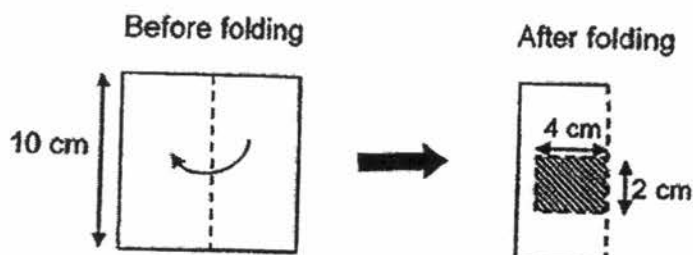

What was the area of the paper after the rectangular strip was cut out?

- (1) 8 cm²
 (2) 16 cm²
 (3) 84 cm²
 (4) 92 cm²

()

18. The number of cookies that Mr Lee baked was between 60 and 80. The cookies could be packed into boxes of 8 or 9 with no cookies left over. How many cookies did Mr Lee bake?

- (1) 63
 (2) 64
 (3) 70
 (4) 72

()

19. Ismail, Jared and Keith shared the cost of a meal. Ismail paid $\frac{1}{8}$ of the bill. Keith paid the same amount as the total sum paid by Ismail and Jared. If the cost of the meal was \$192, how much did Jared pay for the meal?

- (1) \$24
 (2) \$72
 (3) \$96
 (4) \$144

()

20. Jonathan wanted to mark the length of a basketball court with red and blue lines. He marked a red line at the start of the length of the court and carried on with the pattern as shown below. The lines were marked at equal distance apart.

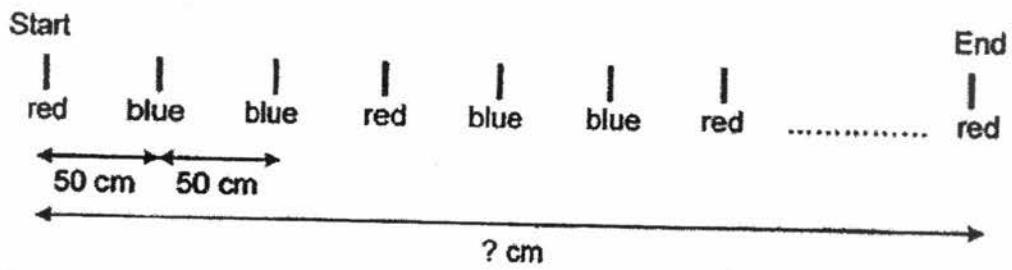

If he marked a total of 10 red lines, what was the length of the basketball court?

- (1) 900 cm
- (2) 1 000 cm
- (3) 1 350 cm
- (4) 1 500 cm

()

Section B: Open-ended Questions (20 × 2 marks)

Questions 21 to 40 carry 2 marks each.

Write out the correct answers for the following questions in the boxes provided.
Show your workings clearly and give your answers in the units provided.

21. Write fifteen thousand and forty-nine in figures.

Ans:

22. Some factors of 32 are 1, 2, 4 and 32. What are the other two factors of 32?

Ans: and

23. What fraction of the stars shown are black in colour?

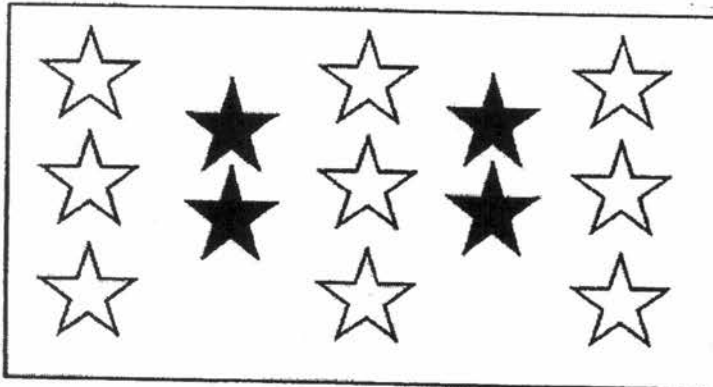

Ans:

24. What is the value of $\frac{5}{6} + \frac{2}{3}$?

Express your answer as a mixed number.

Ans:

25. Arrange the following numbers from the smallest to the greatest.

$$\frac{2}{5}, 0.705, 0.075$$

Ans:

_____	,	_____	,	_____
smallest				greatest

26. Express 0.6 as a fraction.

Ans:

27. $15.86 + 0.09 =$ _____

Ans:

28. Find the value of 2.73×7 .

Ans:

29. In the figure shown, ABCD is a rectangle. Find $\angle FDE$.

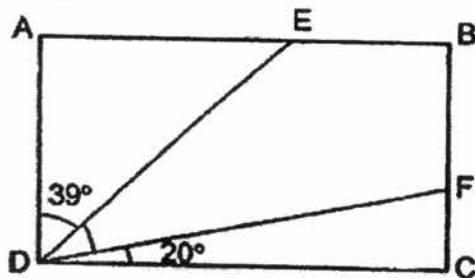

Ans:

30. The following figure is made up of 5 identical squares and a rectangle. The area of a square is 16 cm^2 . What is the perimeter of the figure?

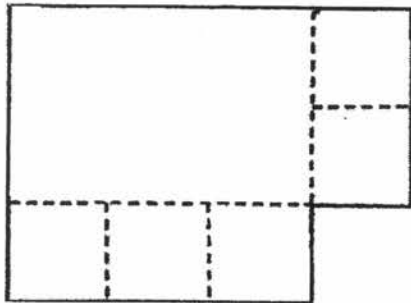

Ans: cm

31. Si Hui was standing in the centre as shown in the diagram below. She made a 225° anti-clockwise turn and ended up facing the Petrol Kiosk. Where was she facing at first?

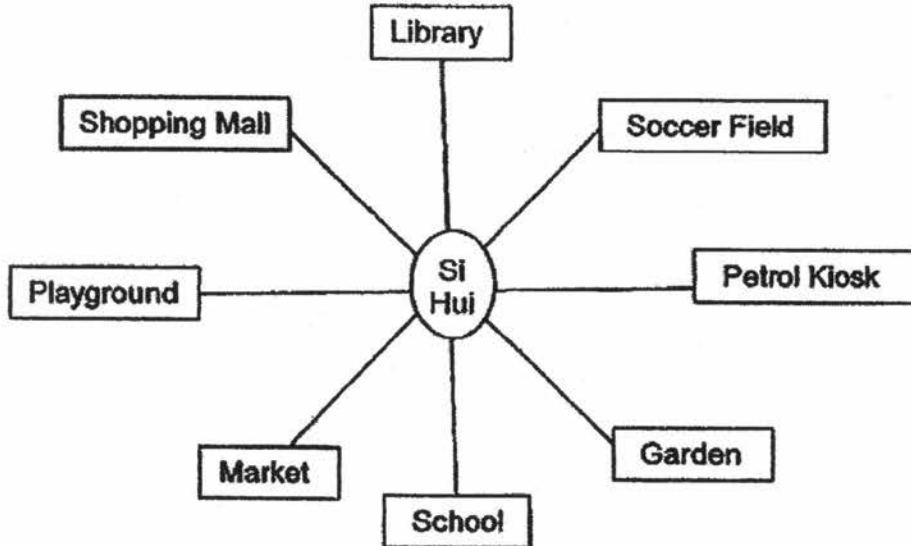

Ans:

32. Shade two more boxes in the figure below such that line AB is the line of symmetry of the figure.

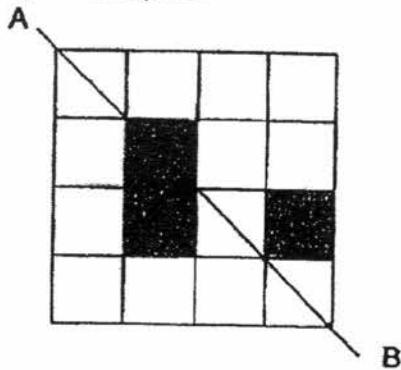

33. Gabriel was given 250 tickets to sell for a charity event. The following line graph shows the number of tickets Gabriel had left at the end of each day.

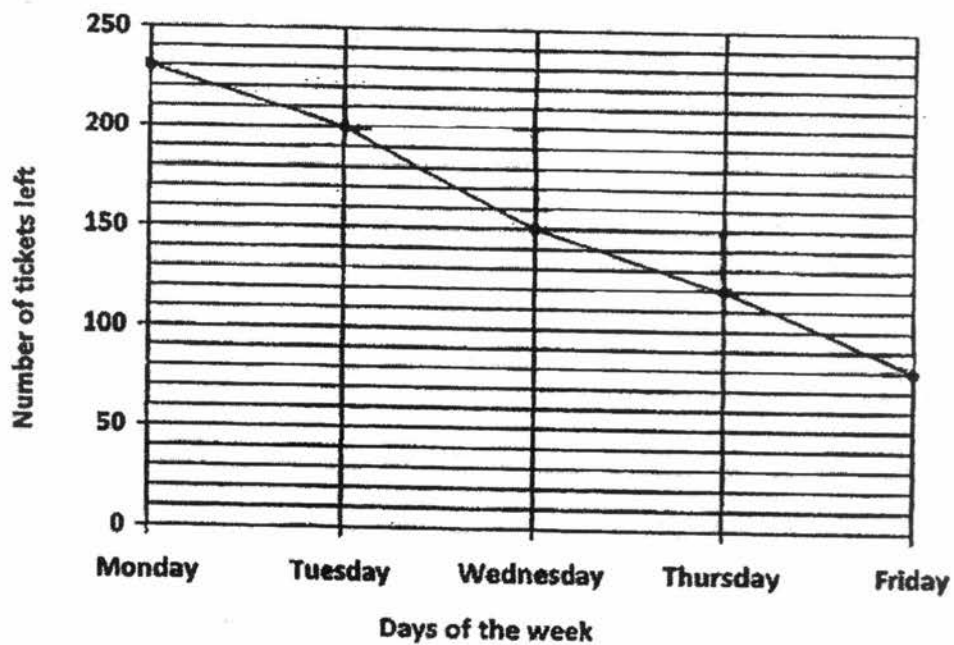

- (a) On which day did Gabriel sell the most number of tickets?
 (b) How many more tickets did Gabriel sell on Friday than on Thursday?

Ans:

(a) _____

(b) _____

34. Hashim jogged around a rectangular field once. The length of the field was twice its breadth. Hashim jogged a total distance of 480 m. What was the breadth of the field?

Ans: m

35. Mabel had 3 m of ribbon. She gave $\frac{1}{3}$ of it to her sister and used 80 cm of the remaining ribbon to tie a present. What was the length of the ribbon she had left?

Ans: cm

36. Find the area of the following figure that is not drawn to scale.

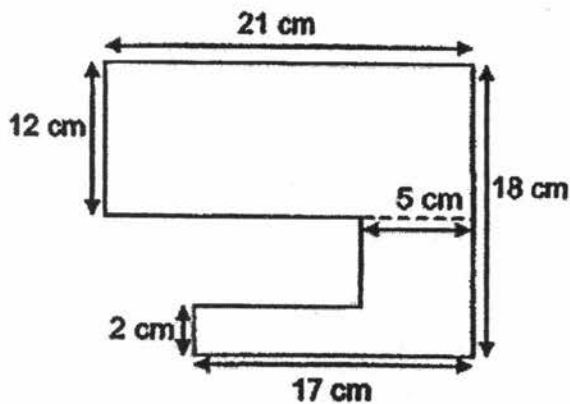

12

Ans: cm²

37. Line AB is drawn on the square grid below.

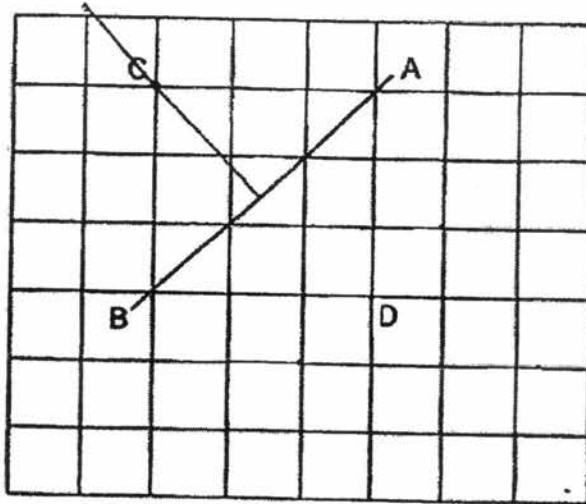

- (a) Draw a line that is perpendicular to Line AB passing through Point C.
(b) Draw a line that is parallel to Line AB passing through Point D.
38. Tommy watched a movie that ended at 10.05 p.m.. The movie lasted 2 h 10 min. What time did the movie start? Leave your answer in 24-hour clock.

Ans:

39. Mrs Chua bought 116 lollipops for her class of 40 pupils. She gave the girls 5 lollipops each and the boys 2 lollipops each. How many girls were there in Mrs Chua's class?

Ans: girls

40. Sally bought some stickers during a sale. A pack of stickers cost \$3. 2 packs of stickers were given free for every 5 packs bought. Sally walked out of the shop with a total of 16 packs of stickers. How much did Sally spend on the stickers?

Ans: \$

Section C (5 × 4 marks)

For each of the following questions, show your workings and mathematical statements in the space below each question. Write your answer in the answer space provided.

41. Susan had 2 079 buttons. She gave $\frac{2}{7}$ of them to Tracy and put the remaining buttons equally into 9 bags. How many buttons were there in each bag?

42. Mr Ramli packed 392 notebooks into 2 boxes, Box A and Box B. When he moved 20 notebooks from Box A into Box B, there were 7 times as many notebooks in Box B as in Box A. How many notebooks were there in Box A at first?

43. At a supermarket, apples were sold at 3 for \$3.50 and pears were sold at 5 for \$4.95. Mrs Tay bought 9 such apples and 10 such pears. How much did Mrs Tay pay for the fruits?

44. Victoria brought twice as much money as Dora on a shopping trip. After Victoria spent \$360 and Dora spent \$110, both of them had the same amount of money left. How much money did Victoria have at first?

45. The following figure shows a picture in a frame which is made up of 4 identical rectangles. Given that the perimeter of the frame is 60 cm and the length of each rectangle is four times its breadth, find the area of the picture.

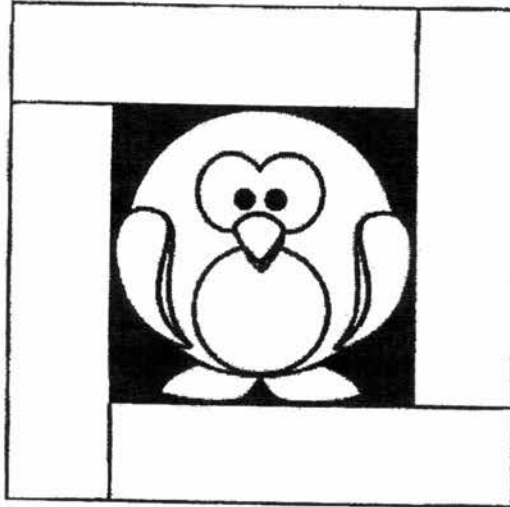

End of Paper

EXAM PAPER 2017 (P4)

SCHOOL : NAN HUA

SUBJECT : MATHEMATICS

TERM : SA2

ORDER CALL :

Q1	Q2	Q3	Q4	Q5	Q6	Q7	Q8	Q9	Q10
4	2	2	2	1	2	4	3	1	4
Q11	Q12	Q13	Q14	Q15	Q16	Q17	Q18	Q19	Q20
2	4	4	3	1	4	3	4	2	3

21)15049

22)16 and 8

23)4/13

24)13/6

25)0.075 , 2/5 , 0.705

26)6/10

27)15.95

28)19.11

29)31°

30)56 cm

31)Shopping Mall

32)

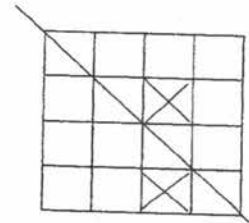

33)a)Wednesday

b)150 - 120 = 30

120 - 80 = 40

40 - 30 = 10

34) $2 + 2 + 1 + 1 = 6$

$380\text{m} \div 6 = 80\text{m}$

35) $3\text{m} \div 3 = 1\text{m}$

$3\text{m} - 1\text{m} = 2\text{m}$

$200\text{m} - 80\text{m} = 120\text{m}$

36) Area of figure A $\rightarrow 21 \times 2 = 252\text{cm}^2$

Area of figure B $\rightarrow 5 \times 4 = 20\text{cm}^2$

Area of figure C $\rightarrow 17 \times 2 = 34\text{cm}^2$

$252\text{cm}^2 + 34\text{cm}^2 + 20\text{cm}^2 = 306\text{cm}^2$

37)a)b)

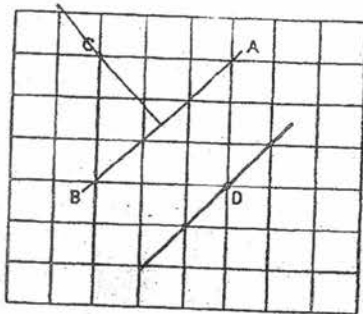

$7.55 \text{ p.m.} = 1955$

39)

Girls	boys		
$20 \times 5 = 100$	$20 \times 2 = 40$	140	X
$10 \times 5 = 50$	$30 \times 2 = 60$	110	X
$11 \times 5 = 55$	$19 \times 2 = 38$	93	X
$8 \times 5 = 40$	$32 \times 2 = 64$	104	X
$12 \times 5 = 60$	$28 \times 2 = 56$	116	✓

ANS: 12 girls

$$40) 2 \times 5 = 10$$

$$2 \times 2 = 4$$

$$10 + 4 = 14$$

$$\$3 \times 5 = \$15$$

$$\$15 \times 2 = \$30$$

$$16 - 14 = 2$$

$$\$3 \times 2 = \$6$$

$$\$30 \times \$6 = \$36$$

$$41) 2079 \div 7 = 297$$

$$297 \times 2 = 594$$

$$2079 - 594 = 1485$$

$$1485 \div 9 = 165$$

There were 165 buttons in each bag.

$$42) 8 \text{ units} \rightarrow 392$$

$$1 \text{ unit} \rightarrow 392 \div 8 = 49$$

$$49 + 20 = 69$$

There were 69 notebooks in Box A at first.

$$43) 9 \div 3 = 3$$

$$3 \times \$3.50 = \$10.50$$

$$10 \div 5 = 2$$

$$\$4.95 \times 2 = \$9.90$$

$$\$10.50 + \$9.90 = \$20.40$$

Mrs Tay paid \$20.40 for the fruits.

44) $1 \text{ unit} \rightarrow \$360 - \$110 = \250

$2 \text{ units} \rightarrow \$250 \times 2 = \$500$

Victoria had \$500 at first.

45) $5 \times 4 = 20$

$60 \div 20 = 3 \text{ cm}$

$15 \text{ cm} - 3 \text{ cm} - 3 \text{ cm} = 9 \text{ cm}$

$9 \text{ cm} \times 9 \text{ cm} = 81 \text{ cm}^2$

The area of the picture is 81 cm^2 .