

PEI CHUN PUBLIC SCHOOL

PRIMARY 4

END-OF-YEAR EXAMINATION 2020

**SCIENCE
SECTION A**

Time: 1 h 45 min

Name: _____ ()

Class: Primary 4 / () _____

Date: 27 October 2020

Science Teacher: _____

INSTRUCTIONS TO CANDIDATES

DO NOT OPEN THIS BOOKLET UNTIL YOU ARE TOLD TO DO SO.

FOLLOW ALL INSTRUCTIONS CAREFULLY.

ANSWER ALL QUESTIONS.

SHADE YOUR ANSWERS ON THE OPTICAL ANSWER SHEET (OAS) PROVIDED.

Section A (28 × 2 marks)

For questions 1 to 28, choose the most suitable answer and shade its number (1, 2, 3 or 4) on the Optical Answer Sheet (OAS) provided.

- 1 The table below shows how some living things can be grouped.

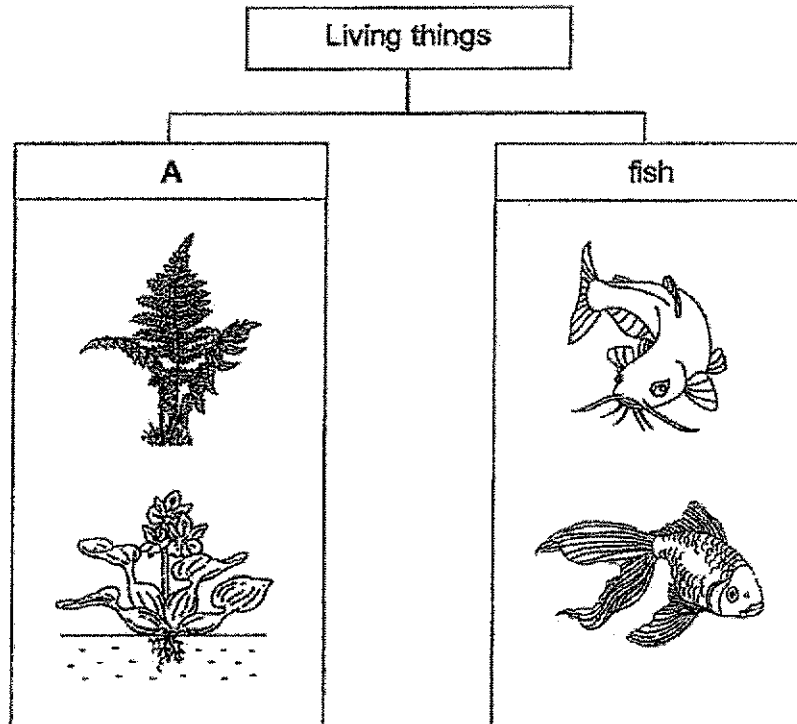

Which one of the following is the most suitable heading for group A?

- (1) fungi
 - (2) plants
 - (3) bacteria
 - (4) mammals
- 2 Which animal is **NOT** a reptile?

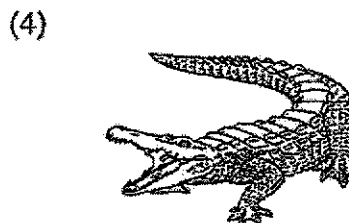
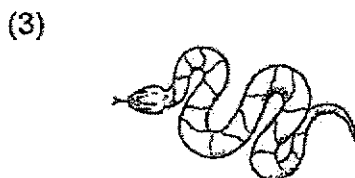
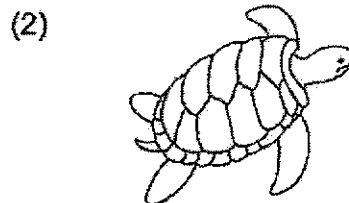

- 3 The diagram shows a man sitting on a raft.



Wood is used to make the raft because wood _____.

- (1) is not shiny
 - (2) breaks easily
 - (3) does not sink in water
 - (4) does not allow light to pass through
- 4 A ball was attracted to a magnet, as shown in the figure below.

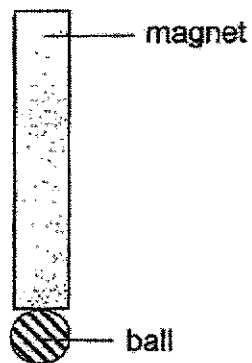

The ball is made of _____.

- (1) steel
- (2) wood
- (3) rubber
- (4) plastic

5 Which of the following shows the correct order when food moves through some parts of the digestive system?

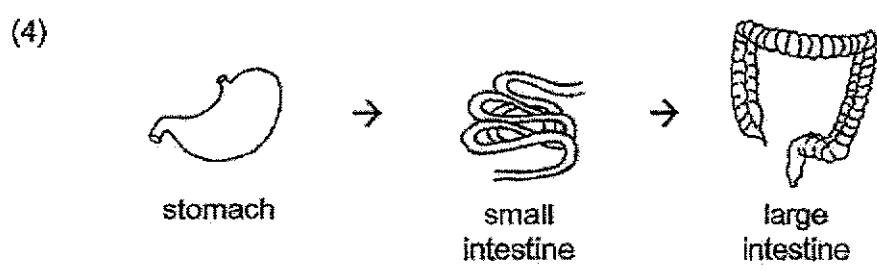
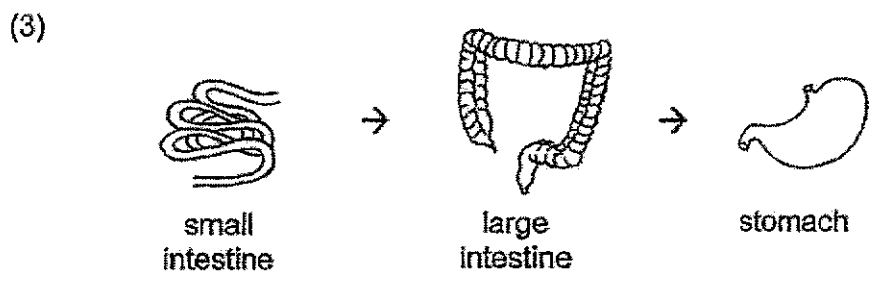
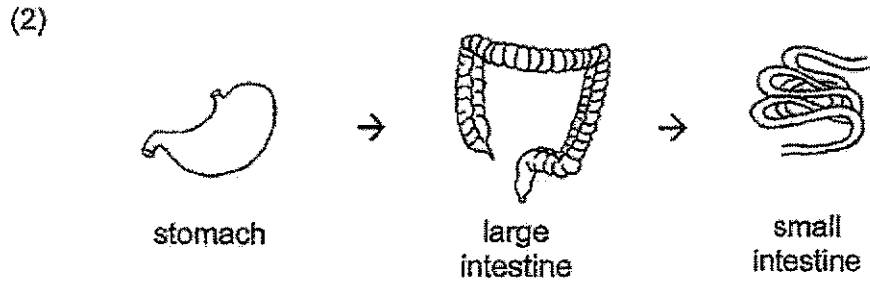
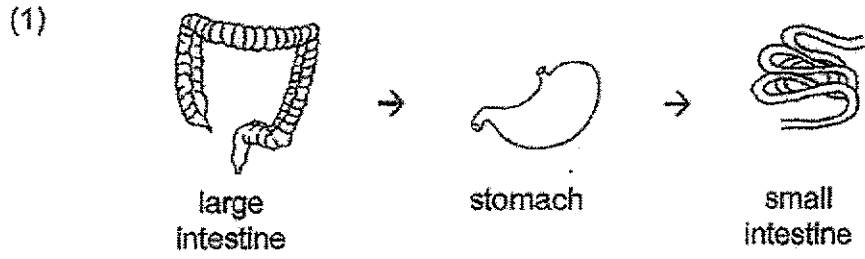

6 The diagram shows a plant.

Which part, (1), (2), (3) or (4), is the stem?

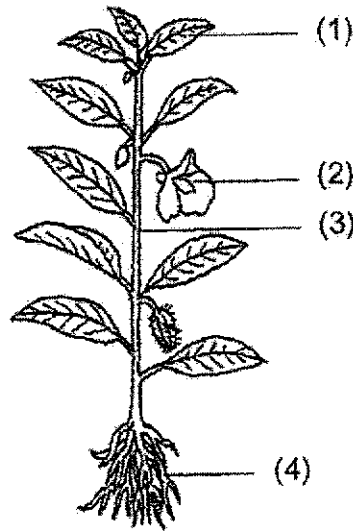

7 Which of the following is a source of light?

(1)

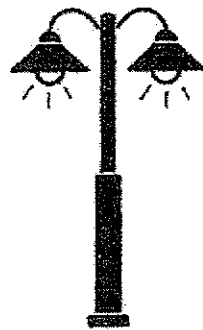

street lamp

(2)



moon

(3)



ring

(4)



mirror

8 The diagram below shows the growth of a young plant with two missing stages Q and R.

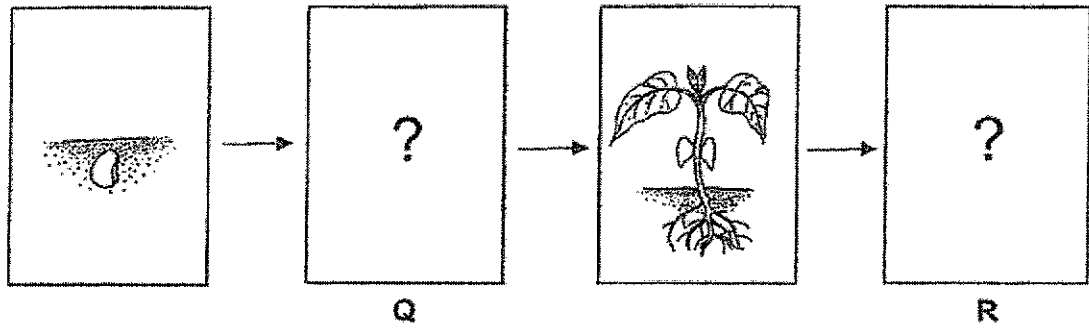

Which one of the following shows the correct stages for Q and R?

	Q	R
(1)		
(2)		
(3)		
(4)		

9 Study the diagram below.

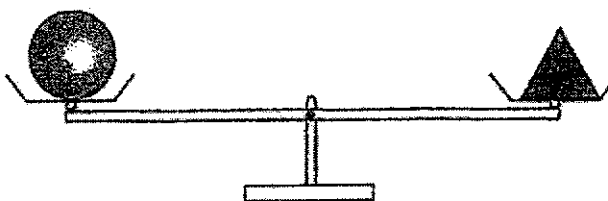

Which of the following statements is true?

- (1) Both objects have the same size.
 - (2) Both objects have the same mass.
 - (3) Both objects have the same shape.
 - (4) Both objects have the same volume.
- 10 Which one of the following is the best conductor of heat?
- (1) a paper plate
 - (2) a metal plate
 - (3) a plastic plate
 - (4) a ceramic plate
- 11 Which of the following can bear fruits?
- (1) fungi
 - (2) bacteria
 - (3) flowering plants
 - (4) non-flowering plants

12 Aisha wanted to keep a hamster as a pet. She thought of three possible ways A, B and C to keep her hamster.

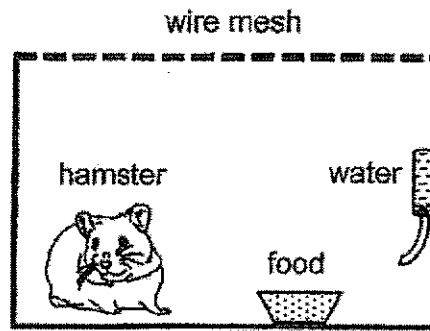

A

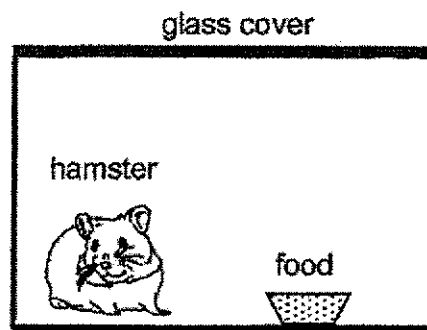

B

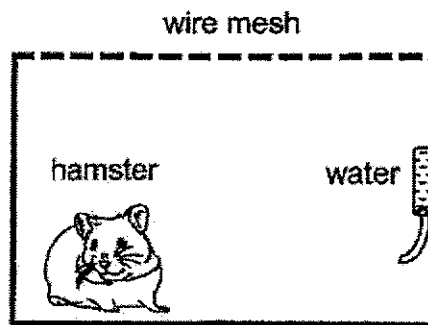

C

Which one of the following is correct?

	Least suitable way to keep the hamster	Most suitable way to keep the hamster
(1)	A	B
(2)	B	A
(3)	B	C
(4)	C	A

- 13 Jasper observed a living thing under the microscope.

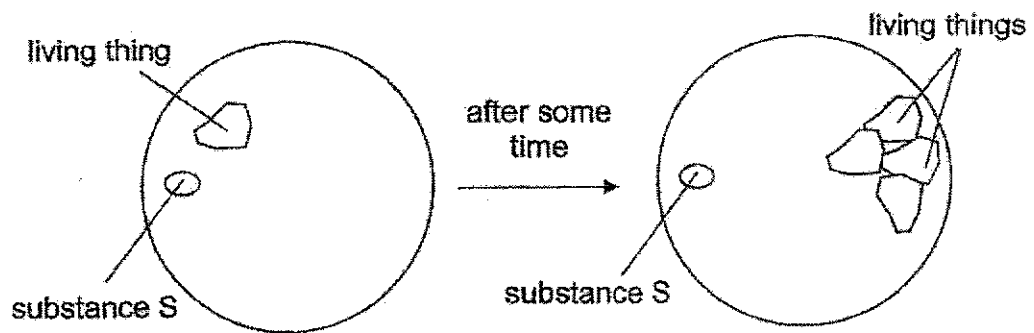

Based on Jasper's observation, which is the correct conclusion?

- A : Living things grow.
- B : Living things respond.
- C : Living things reproduce.

- (1) A only
- (2) B only
- (3) A and C only
- (4) B and C only

- 14 The table shows Ivan's answers to four questions about moss.

Question	Answer
A – Does it have seeds?	Yes
B – Can it produce flowers?	Yes
C – Can it make its own food?	Yes
D – Does it take in water to survive?	No

Which question was answered correctly?

- (1) A
- (2) B
- (3) C
- (4) D

15 Hassan had to classify the three animals shown.

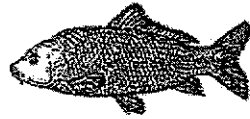

carp



lizard



frog

He classified them with the help of the chart below.

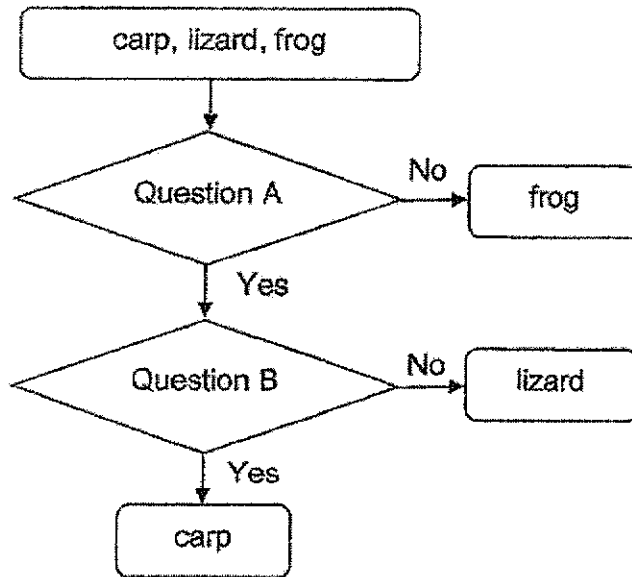

What are questions A and B?

	Question A	Question B
(1)	Do they have legs?	Do they breathe through gills?
(2)	Do they have legs?	Can they live on land and in water?
(3)	Are they covered with scales?	Do they breathe through gills?
(4)	Are they covered with scales?	Can they live on land and in water?

16 Where can bacteria be found?

- A : in the body of living things
- B : on the furniture in the classroom
- C : in the food we eat

- (1) B only
- (2) A and B only
- (3) A and C only
- (4) A, B and C

17 A student made three statements about bacteria and mushroom.

- A : They reproduce by spores.
- B : They do not make their own food.
- C : They can be seen only under a microscope.

Which of the following is correct?

	Bacteria	Mushroom
(1)	A, B	C
(2)	B, C	A, B
(3)	B, C	C
(4)	A, B, C	A, B

18 Which of the following correctly identifies the parts of the digestive system?

	digestion begins	digested food absorbed into blood
(1)	mouth	small intestine
(2)	stomach	small intestine
(3)	mouth	large intestine
(4)	small intestine	large intestine

- 19 Bin Xun hangs four weights on four pieces of strings, W, X, Y and Z, based on the maximum mass each piece of string can hold as shown below. The strings are of the same length and each piece is made of a different material.

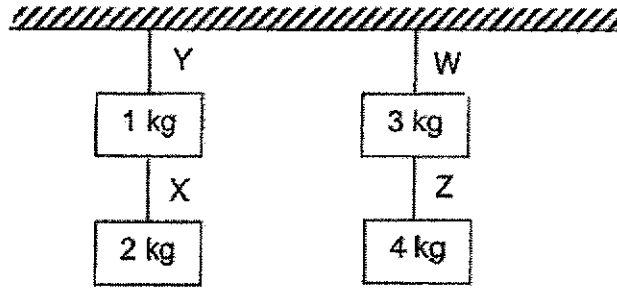

Which of the following correctly shows the four strings arranged from the weakest to the strongest?

- Weakest $\xrightarrow{\hspace{10em}}$ Strongest
- | | | | | |
|-----|---|---|---|---|
| (1) | Y | X | W | Z |
| (2) | X | Y | Z | W |
| (3) | W | Z | Y | X |
| (4) | X | Z | Y | W |

- 20 Mary stroked three bars with the same magnet in the directions shown below.

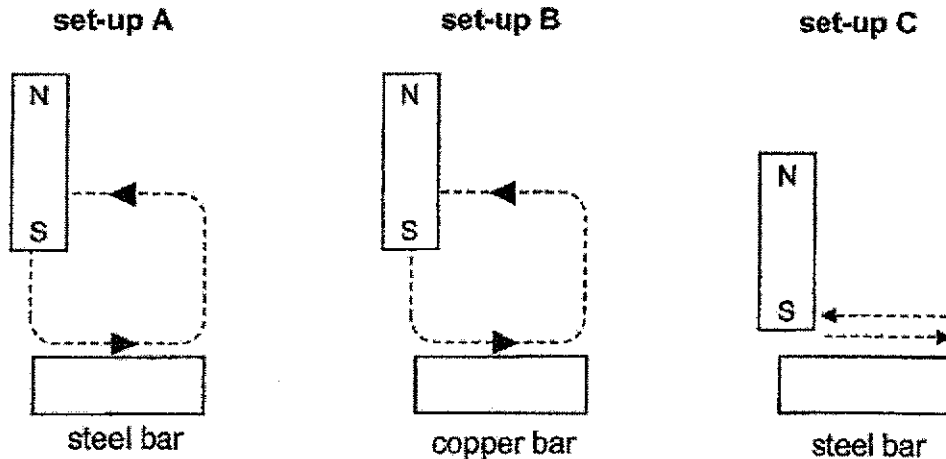

After thirty strokes, what would most likely be the number of paper clips attracted to the bar in each set-up?

	set-up A	set-up B	set-up C
(1)	0	3	3
(2)	0	3	0
(3)	3	0	3
(4)	3	0	0

21 Three bar magnets AB, CD and EF can be arranged as shown below.

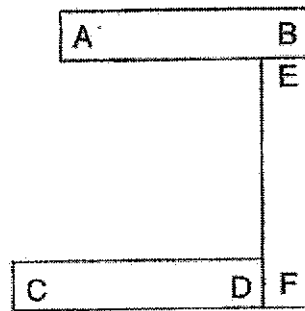

Which one of the following arrangements of the magnets is **NOT** possible?

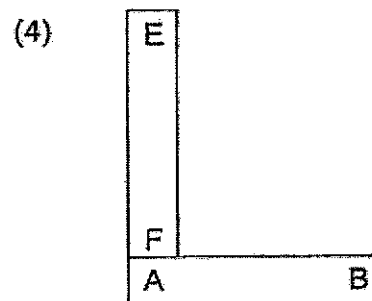
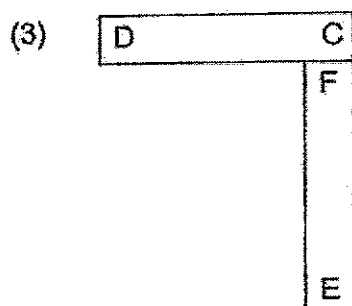
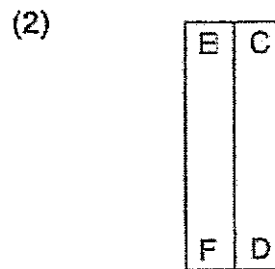
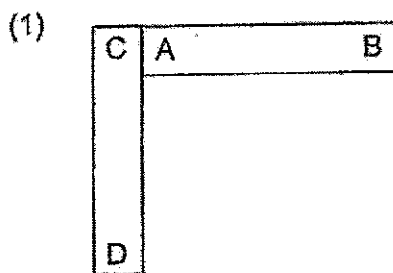

22 There are gaps between railway tracks as shown below.

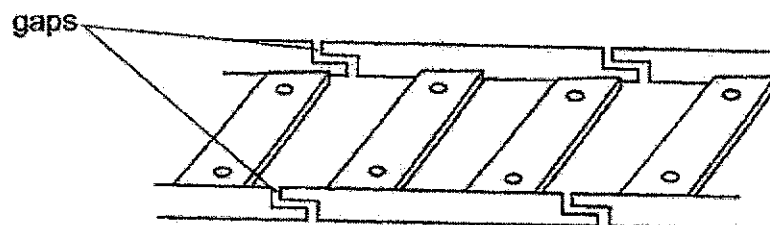

On a hot day, the gaps allow the railway tracks to _____.

- (1) gain heat and expand
- (2) gain heat and contract
- (3) lose heat and expand
- (4) lose heat and contract

- 23 The diagram shows plant M growing on a high branch of a tree in the forest.

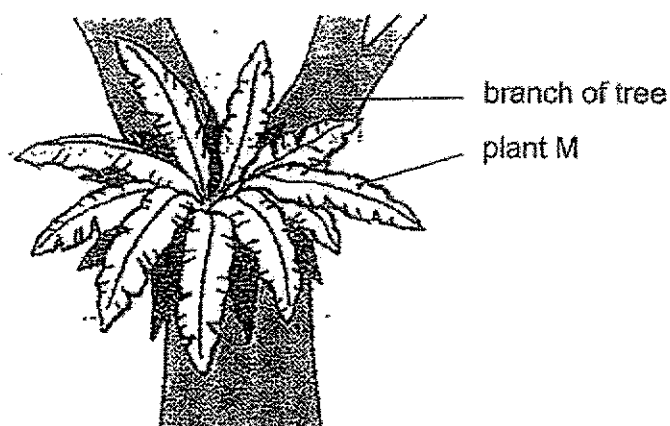

The leaves of plant M can _____.

- (1) make its own food
 - (2) keep the tree upright
 - (3) get food from the tree
 - (4) absorb water from the branch
- 24 Ali drew a table and used it to compare the life cycles of some living things.

Characteristic	Life Cycle		
	mosquito	chicken	grasshopper
Does the young look like the adult?	No	Answer Q	Yes
Question P	No	Yes	Yes

What can Question P and Answer Q be?

	Question P	Answer Q
(1)	Does it lay eggs on land?	Yes
(2)	Does it lay eggs on land?	No
(3)	Does it give birth to its young?	Yes
(4)	Does it give birth to its young?	No

- 25 Muthu studied the life cycle of insect X and recorded the number of months for each stage of its life cycle shown below. However, he did not present the stages of the life cycle in the correct order.

Stages	Number of months
nymph	6
egg	1
adult	8

Based on Muthu's results, how many month(s) does it take for insect X to become an adult after the egg has hatched?

- (1) 1 month
 - (2) 5 months
 - (3) 6 months
 - (4) 8 months
- 26 The container holds 40 cm^3 of water and 60 cm^3 of air.

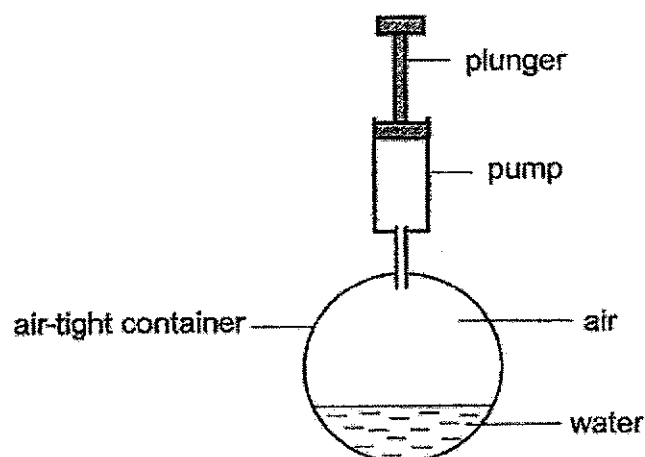

When the plunger was pushed in completely, 10 cm^3 of air was forced into the container. What would be the final volume of the air in the container?

- (1) 40 cm^3
- (2) 50 cm^3
- (3) 60 cm^3
- (4) 70 cm^3

- 27 Boon Ping heated different volumes of water to different temperatures as shown in the table below.

beaker	volume of water (ml)	temperature ($^{\circ}\text{C}$)
A	70	30
B	70	40
C	80	30

Which of the following is true?

- (1) The water in beaker A has less heat than the water in B.
 - (2) The water in beaker A has more heat than the water in C.
 - (3) The water in beaker A has the same amount of heat as the water in B.
 - (4) The water in beaker A has the same amount of heat as the water in C.
- 28 Jenny conducted an experiment to find out whether light can pass through three sheets, A, B and C, made of different materials. She arranged the sheets differently in set-ups P and Q as shown.

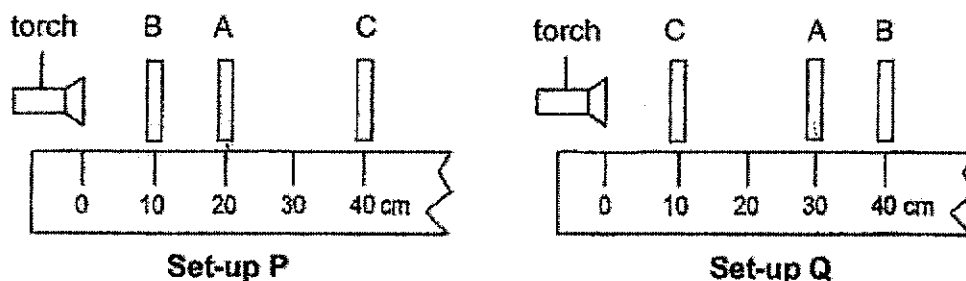

When the torch was switched on, the distance travelled by the light for each set-up was measured and are shown below.

	Distance travelled by light
Set-up P	20 cm
Set-up Q	30 cm

Which sheet(s) did not allow light to pass through?

- (1) A only
- (2) C only
- (3) A and C only
- (4) B and C only

End of Section A

PEI CHUN PUBLIC SCHOOL
PRIMARY 4
END-OF-YEAR EXAMINATION 2020

SCIENCE
SECTION B

Time: 1h 45 min

Name: _____ ()

Class: Primary 4 / () _____

Date: 27 October 2020

Science Teacher: _____

Parent's Signature: _____

SECTION A	56
SECTION B	44
TOTAL	100

INSTRUCTIONS TO CANDIDATES

DO NOT OPEN THIS BOOKLET UNTIL YOU ARE TOLD TO DO SO.

FOLLOW ALL INSTRUCTIONS CAREFULLY.

ANSWER ALL QUESTIONS.

WRITE YOUR ANSWERS IN THIS BOOKLET.

Section B (44 marks)

For questions 29 to 41, write your answers in the spaces provided.

29 Hui Fen saw some living and non-living things in the garden.

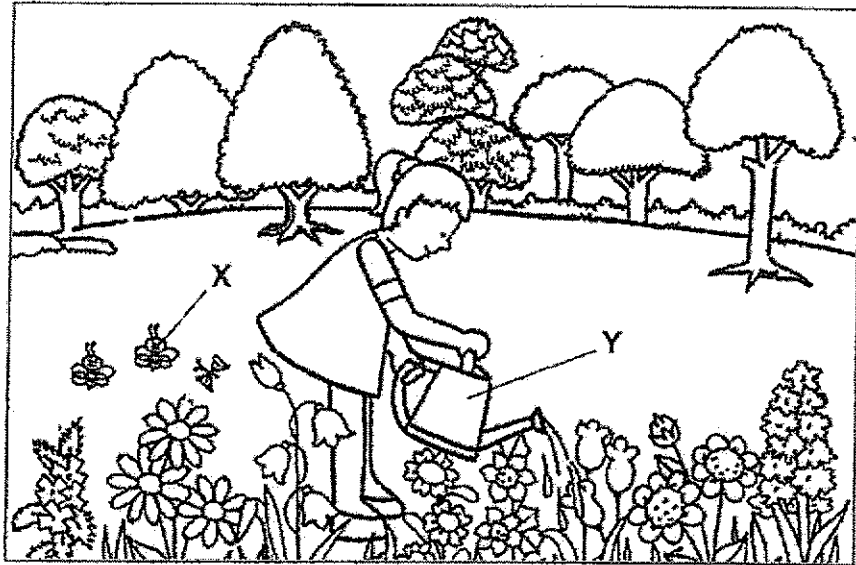

State if X and Y are living or non-living things.

(a) X is a _____.

[1]

(b) Y is a _____.

[1]

SCORE	
-------	--

30 Draw lines to match the three organ systems to their functions. [3]

organ systems	functions
skeletal system ● circulatory system ● respiratory system ●	<ul style="list-style-type: none"> ● removes solid wastes ● transports substances to all parts of the body ● supports the body and gives it shape ● takes air into and out of the body

31 The diagram below shows the stages in the life cycle of a butterfly.

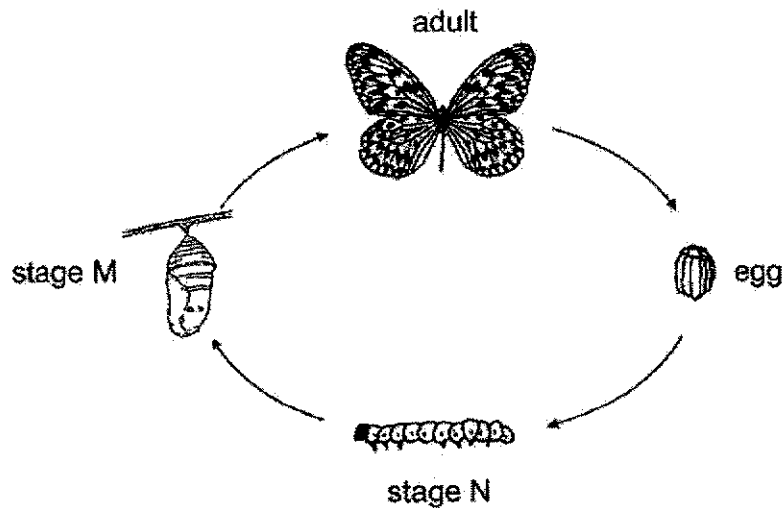

(a) Name Stage M and N. [2]

Stage M: _____

Stage N: _____

(b) State one other animal that has a similar number of stages in its life cycle as a butterfly. [1]

SCORE	
-------	--

- 32 Max used an instrument to measure the temperature of water.

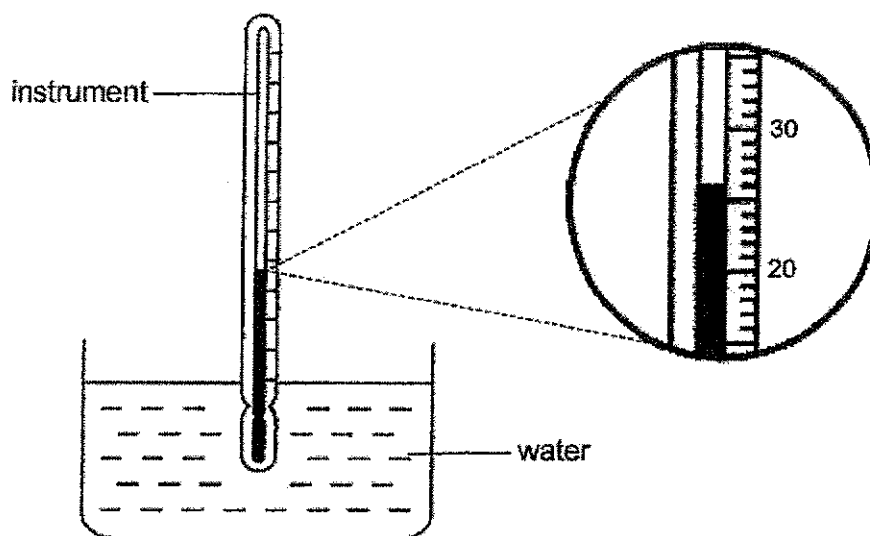

- (a) What is the instrument called? [1]

- (b) What is the temperature of water? [1]

_____ °C

33 Riya classified four animals in the chart below.

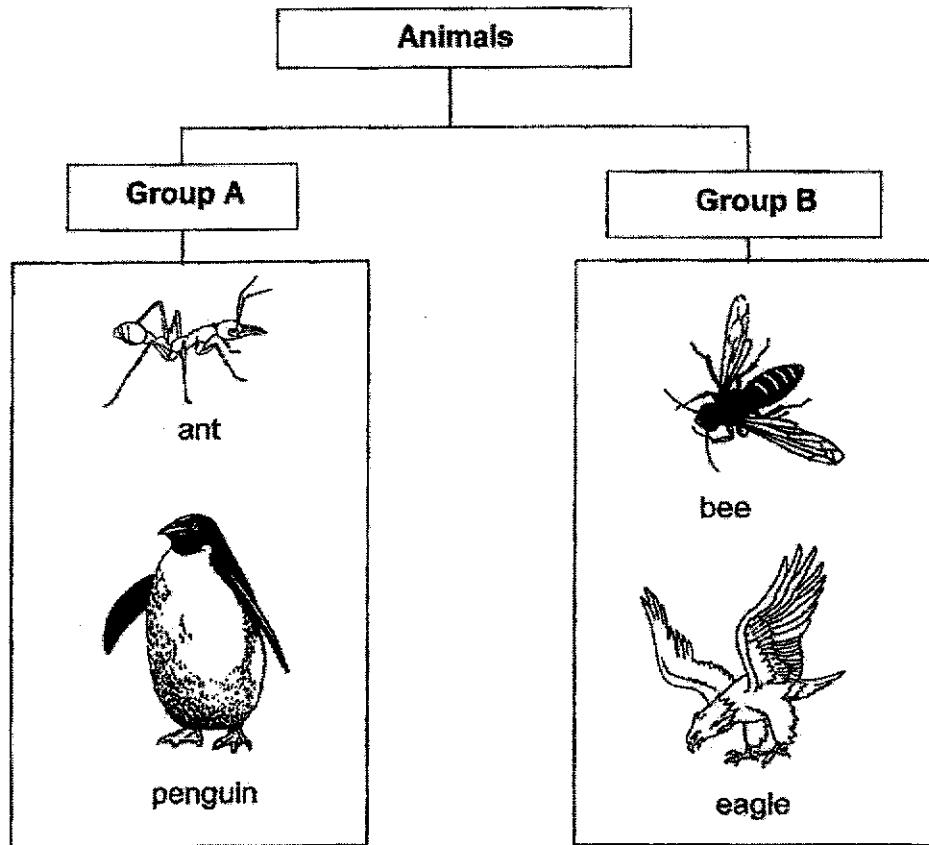

(a) Based on the chart above, what characteristic did Riya use to group the animals? [1]

Group A: _____ Group B: _____

(b) Use another characteristic to regroup all the four animals in the chart in (a) into two groups. Give a suitable heading for each group. You do not need to draw the animals. [2]

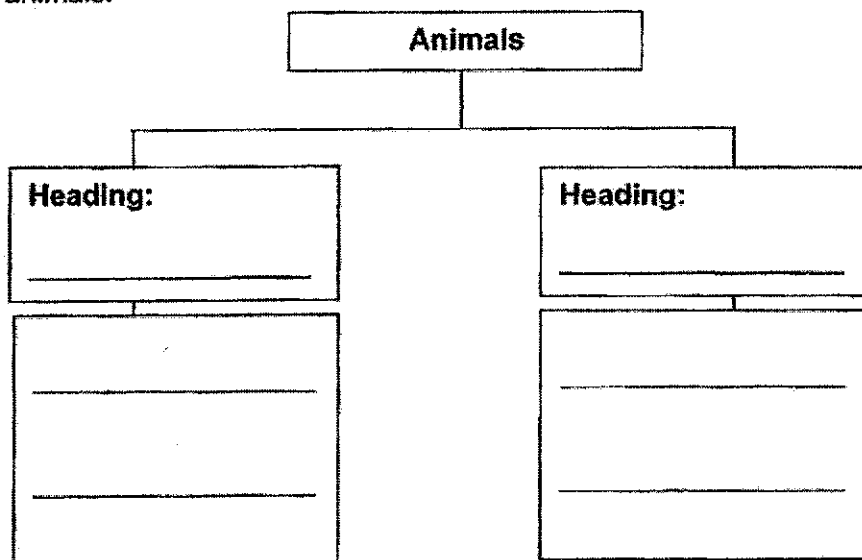

SCORE	
-------	--

(c) The diagram shows two animals.

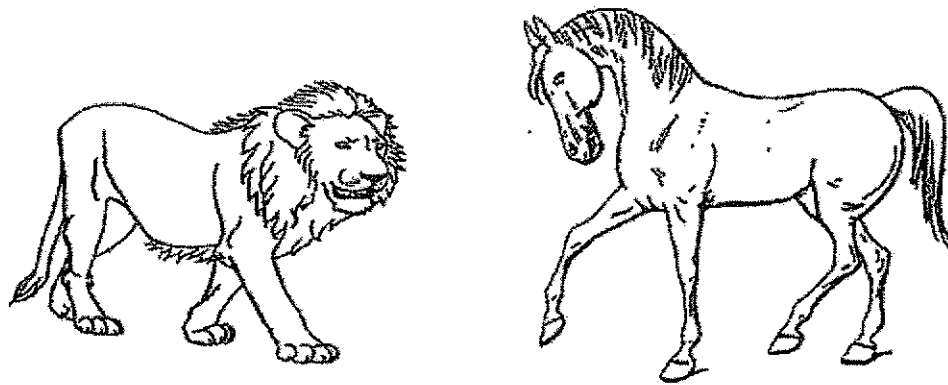

(i) Which animal group do these animals belong to? [1]

(ii) State one characteristic of this animal group. [1]

SCORE	
-------	--

- 34 Liling placed four similar tomatoes in four identical sealed containers. She placed containers A and B in a cold place and containers C and D in a warm place. Substance X removes the air in the container.

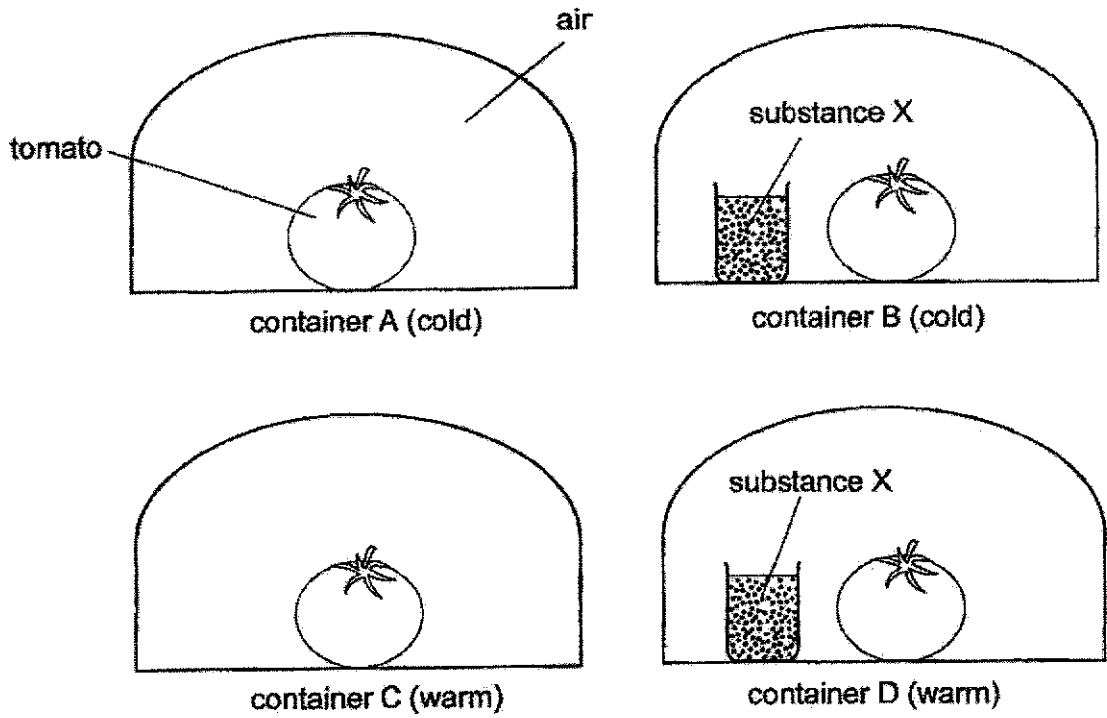

In which container, A, B, C or D, would mould first appear on the tomato? Explain your answer. [2]

SCORE	
-------	--

- 35 Jia Wei used the set-up shown below to study a certain property of material. He hung four strips of fabric made of different materials from a pole. All strips had one end placed into a container of red coloured water.

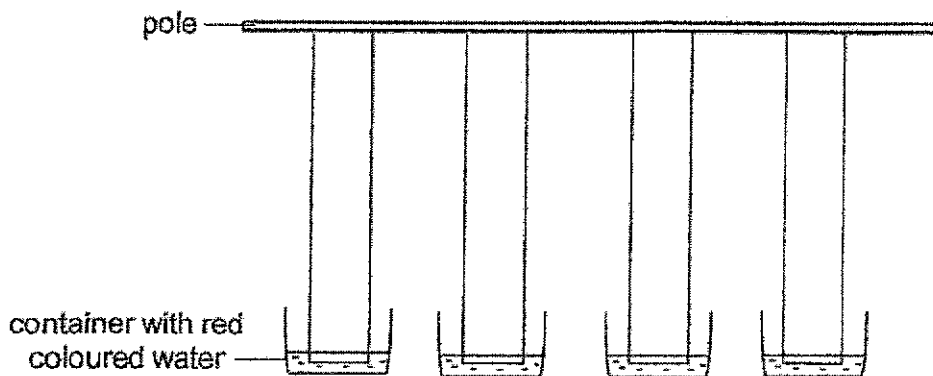

The diagram below shows the shaded parts of the strip that were stained red at the end of the experiment.

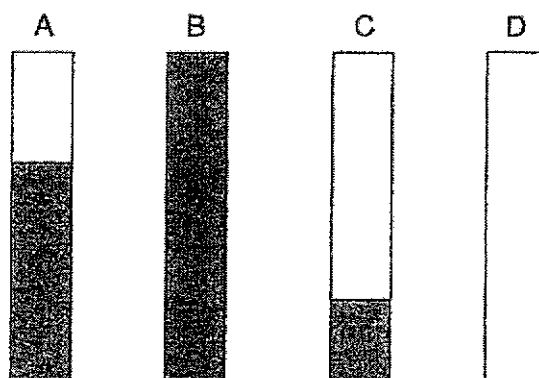

- (a) A raincoat helps to keep out the rain as shown below.

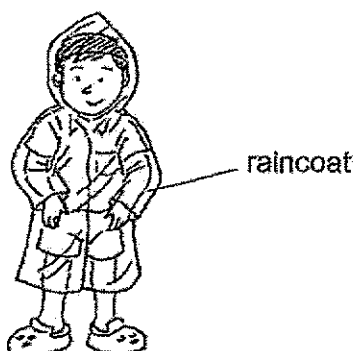

- (i) State a physical property of fabric D that makes it most suitable to be used to make a raincoat. [1]
-
- (ii) State another property of the fabric that allows the boy to move his arms easily when he is wearing the raincoat. [1]
-

SCORE	
-------	--

- (b) Jia Wei repeated his experiment with strips A, B, C and D. This time, he placed the strips with identical mass into a bucket of water and removed the strips from the bucket to weigh after five minutes.

Which strip, A, B, C or D, would have the least mass after five minutes? [1]

- (c) Jia Wei conducted another experiment using the four strips. He wanted to find out if the thickness of a strip of fabric C affects the amount of water absorbed by the strip.

Tick (✓) two variables that Jia Wei must keep constant to ensure a fair test.

[2]

- length of the strip
- material of the strip
- thickness of the strip
- amount of water absorbed by the strip

SCORE	
-------	--

- 36 Ellie wanted to investigate how the number of batteries affects the strength of the electromagnet using the set-up below.

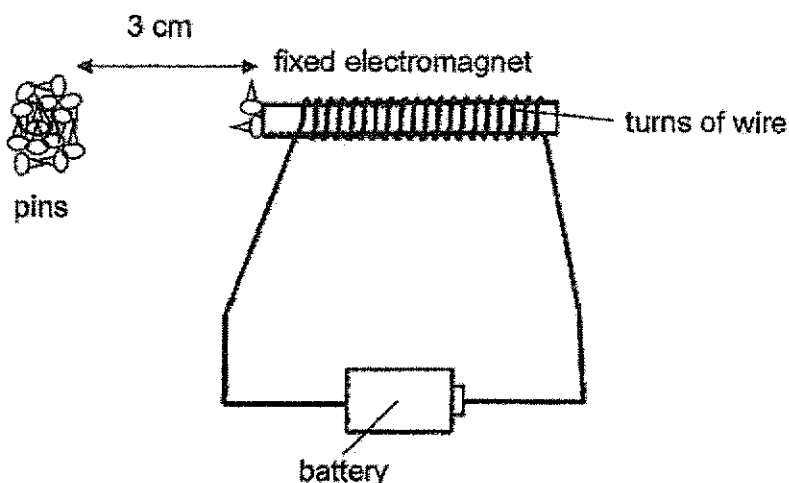

She placed the electromagnet 3 cm from some pins and counted the number of pins that were attracted to it.

Her results are shown below.

Number of batteries	Number of pins attracted to electromagnet
1	2
2	4
3	6
4	8

- (a) What is the relationship between the number of batteries and the strength of the electromagnet? [1]
- _____
- _____
- (b) Using the same set-up above, suggest another way Ellie could increase the strength of the electromagnet. [1]
- _____
- _____
- (c) Ellie repeated her experiment and placed the pins 6 cm away from the electromagnet. Would the magnetic attraction on the pins be *stronger*, *weaker* or *the same as before*? [1]
- _____

SCORE	
-------	--

- (d) When a bar magnet was placed near the electromagnet, it moved away from the electromagnet as shown below.

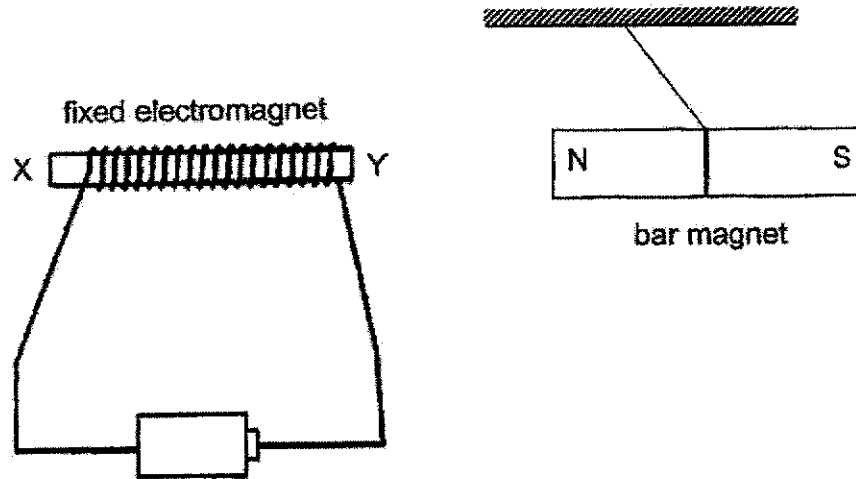

- (i) Name the poles X and Y of the electromagnet. [1]

X: _____

Y: _____

- (ii) Explain your answer for (i) above. [1]

SCORE	
-------	--

37 Reyna conducted an experiment in a classroom using plants S, T and U as shown. She recorded the water level, H, at regular time intervals.

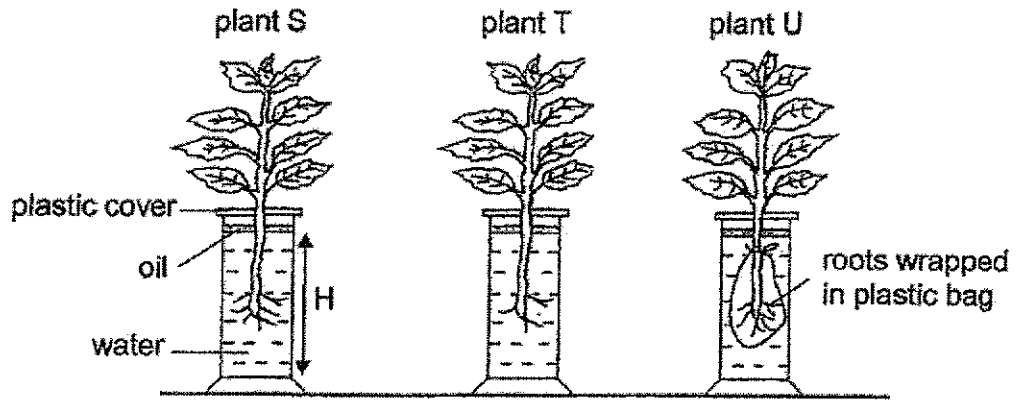

(a) Which two plants should be compared to show that the roots of the plant absorb water? [1]

Plants _____ and _____

(b) Identify the line that represents the results obtained for the plants in the graph below. Fill in the boxes with plants S, T and U. [1]

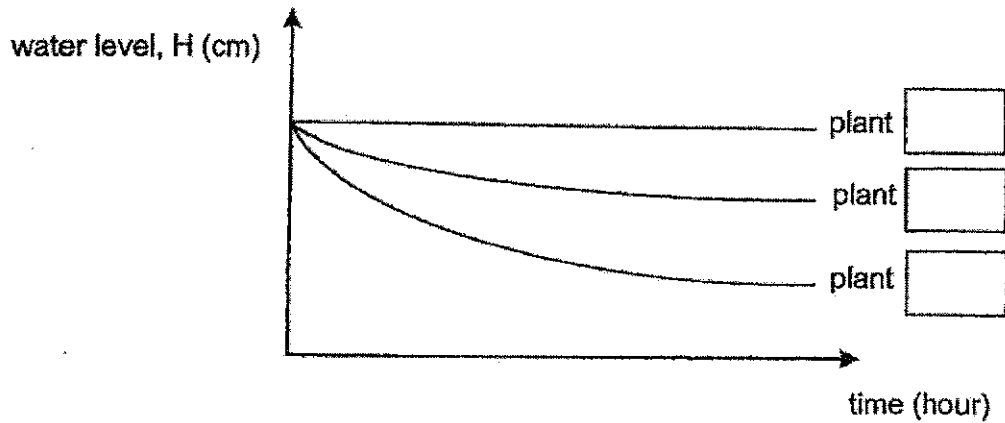

SCORE	
-------	--

(c) The diagram below shows part of a slope.

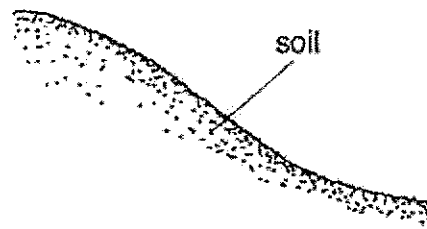

A farmer wanted to grow a type of plant on the slope.

Which of the following plants, D or E, can the farmer grow so that the plants would not be easily washed away by the heavy rain? Explain your answer. [1]



Plant D

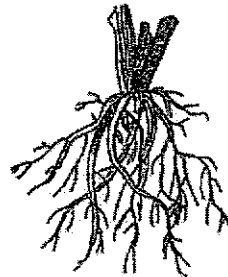

Plant E

SCORE	
-------	--

- 38 Ah Seng wanted to find out the most suitable temperature on the growth of seeds. He planted four seeds, each at a different temperature and counted the number of days for roots to appear.

The graph below shows his results.

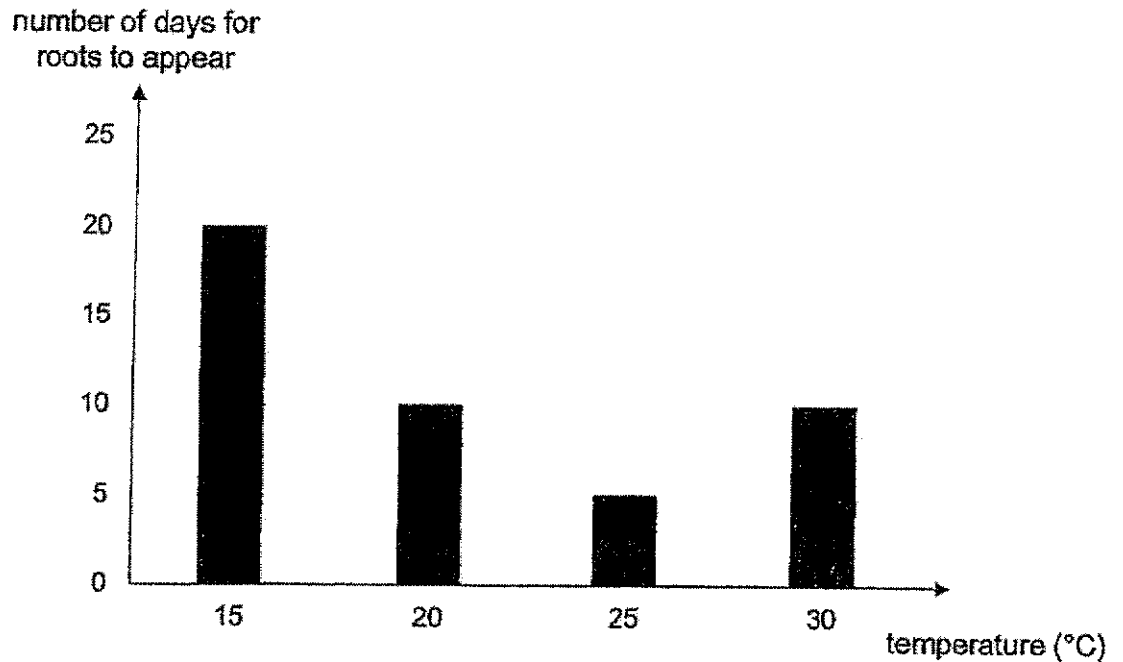

- (a) Based on Ah Seng's results, at which of the above temperatures did the seed grow the fastest? [1]

- (b) Other than warmth, name another condition that the seeds need to grow. [1]

- (c) The diagram below shows one of the seeds that Ah Seng observed after some time.



Which stage of the plant's life cycle did he observe?

[1]

SCORE	
-------	--

39 A pebble was placed in a dish as shown below.



Jannah transferred the pebble into a beaker as shown below.

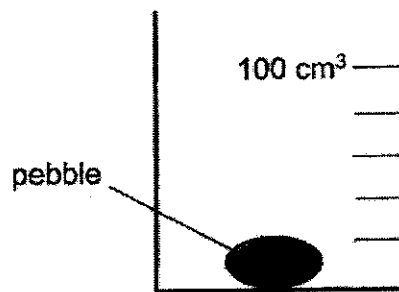

(a) Based on her observation, state if the pebble is *solid, liquid or gas* and give a reason for your answer. [1]

(b) Jannah poured some water into the beaker as shown in Diagram 1. Next, she removed the pebble from the beaker in Diagram 2.

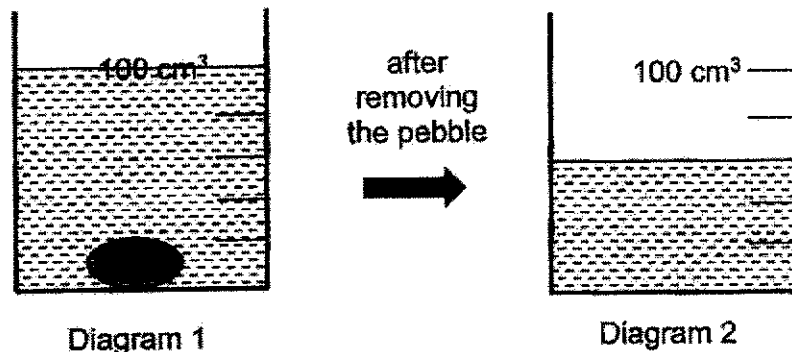

(i) Explain why the water level dropped after the pebble was removed from the beaker in Diagram 2. [1]

(ii) What is the volume of the pebble? [1]

_____ cm³

SCORE	
-------	--

40 Kumar had three wooden frames as shown below.

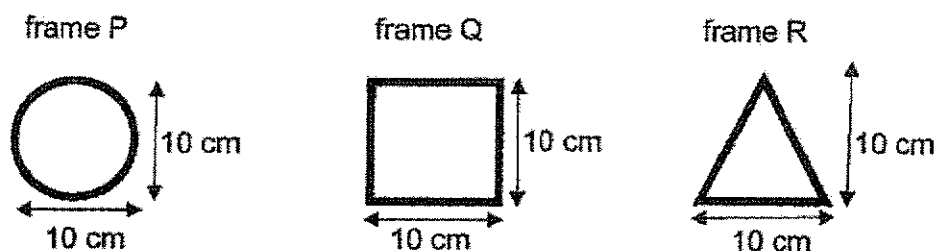

He hung the frames between a torch and a screen. The shadows formed on the screen are as shown below.

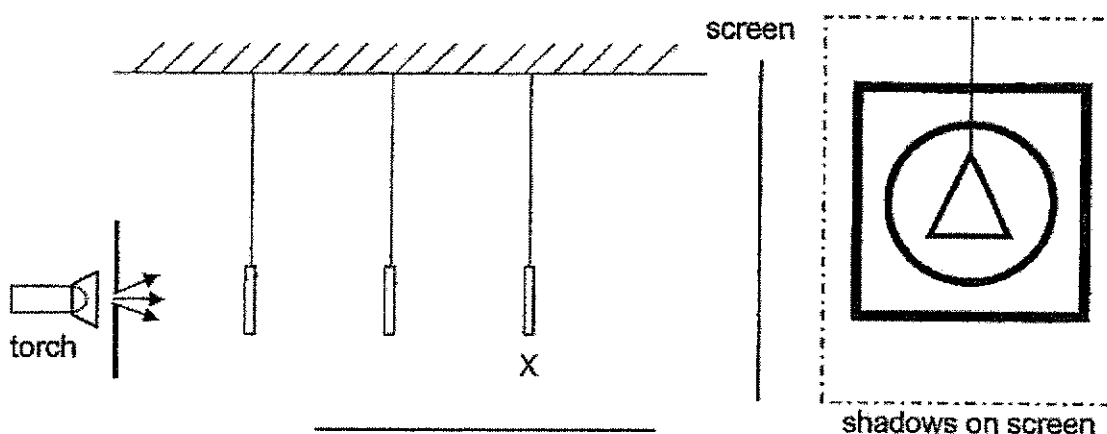

- (a) When the torch was switched on, Kumar was able to see the wooden frames in a dark room. Explain why. [1]

- (b) Which frame was hung at position X? [1]

Frame _____

- (c) Shadows were formed on the screen. State a property of light that causes shadows to form. [1]

SCORE	
-------	--

(d) Kumar removed all the wooden frames and hung object T between the torch and the screen.

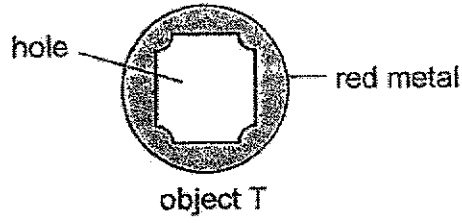

Which of the following shadows could be formed by object T?
Tick (✓) the correct box.

[1]

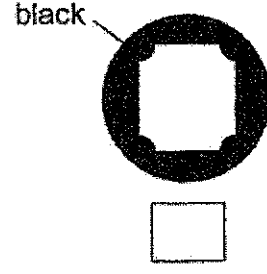
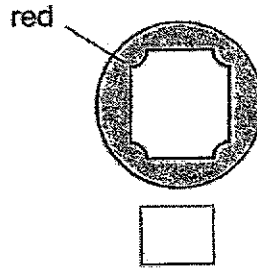
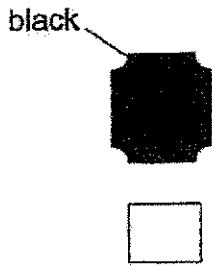

SCORE	
-------	--

- 41 Peter conducted an experiment using the set-up shown below.

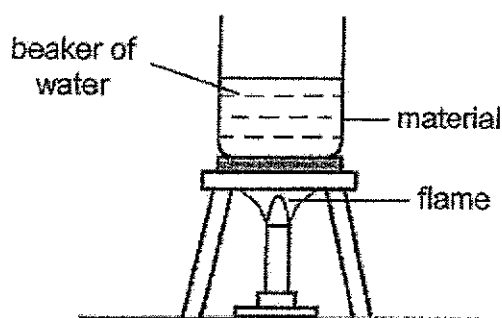

He poured the same volume of water into three identical beakers. He recorded the time taken for water to boil when materials E, F and G were placed below the beaker of water.

His results are shown in the graph below.

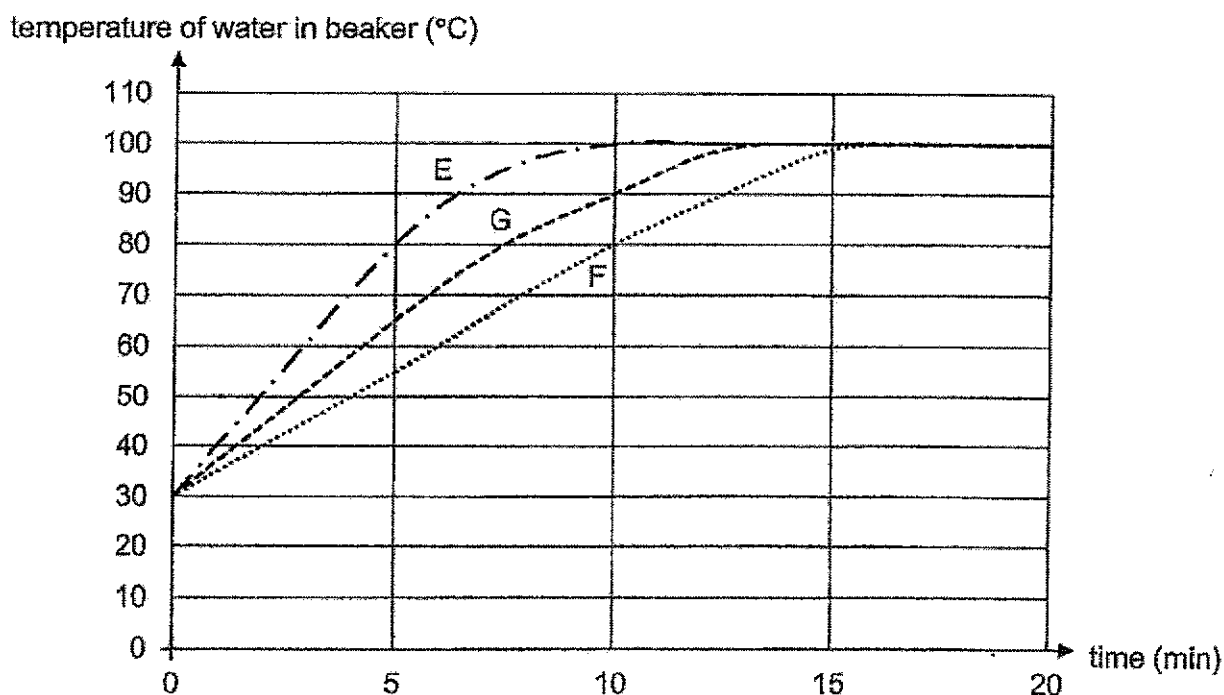

- (a) What was the temperature of the water at the start of the experiment? [1]

_____ $^{\circ}\text{C}$

- (b) Explain why the temperature of the water in all three beakers change with time. [1]

SCORE	
-------	--

- (c) Peter wants to bring a container of cold drinks for a picnic. He wants to keep the drinks cold for the longest period of time.

Based on the results, which material, E, F or G is most suitable for wrapping the container? Explain your answer. [2]

End of Section B

Set by : Ms Nifah and Mrs Candice Gwee
Vetted by: Mdm Samantha Gooi and Ms Tan Hwee San

SCORE	
-------	--

ANSWER KEY

YEAR: 2020

LEVEL: PRIMARY 4

SCHOOL: PEI CHUN PUBLIC SCHOOL

SUBJECT: SCIENCE

TERM: END OF YEAR EXAMINATION

Q1	2	Q2	1	Q3	3	Q4	1	Q5	4
Q6	3	Q7	1	Q8	4	Q9	2	Q10	2
Q11	3	Q12	2	Q13	4	Q14	3	Q15	3
Q16	4	Q17	2	Q18	1	Q19	2	Q20	4
Q21	3	Q22	1	Q23	1	Q24	1	Q25	3
Q26	3	Q27	1	Q28	1				

Q29	(a) X is a living thing (b) Y is a non-living thing		
Q30	<p> ● removes solid wastes ● transports substances to all parts of the body ● supports the body and gives it shape ● takes air into and out of the body </p>		
Q31	(a) Stage M: Pupa Stage N: Larva (b) Mosquito		
Q32	(a) Thermometer (b) 26°C		
Q33	(a) Group A: cannot fly Group B: can fly (b)		
	<table border="1"> <tr> <td>Have feathers Penguin Eagle</td> <td>No feathers Ant Bee</td> </tr> </table>	Have feathers Penguin Eagle	No feathers Ant Bee
Have feathers Penguin Eagle	No feathers Ant Bee		
	(c)(i) Mammals (ii) They have hair on their bodies.		

Q34	C. Mould needs air and warmth to grow. Only container C has air and warmth. Hence, mould will first appear on container C.
Q35	(a)(i)It is waterproof (ii)It is flexible (b)Strip D (c)✓Length of the strip ✓Material of the strip
Q36	(a)As the number of batteries increases, the strength of the electromagnet increases. (b)She could increase the number of turns of wire around the bar. (c)Weaker (d)(i)X:South Y:North (ii)The North pole of the bar magnet and part Y of the electromagnet repelled each other. When like poles of two magnets are facing each other, they repel. Hence, Y is also north and X is south.
Q37	(a)Plant S and V (b)Plant V, T, S (c)Plant E. Plant E has more roots than plant D to anchor it firmly into the soil, so it will not be easily washed away by the heavy rain.
Q38	(a)At 25°C (b)Water (c)Young stage
Q39	(a)Solid. The pebble did not take the shape of the beaker and dish so it has a definite shape. Only solids have a definite shape. (b)(i)The pebble is a matter and occupied space in the beaker so when the pebble is removed, the water level will drop as the water will occupy the space previously occupied by the pebble. (ii)40cm ³
Q40	(a)The light from the torch was reflected by the wooden frames and entered Kumar's eyes. (b)Frame R (c)Light travels in a straight line. (d)*tick the 3 rd box*
Q41	(a)30°C (b)The water in the beakers gained heat from the flame. Hence, the temperature of the water in the beaker increased and changed with time.

	(c)Material F. The temperature of the water increased the slowest.Material F is the poorest conductor of heat.
--	--

3

END .