

**NAN HUA PRIMARY SCHOOL
MID-YEAR EXAMINATION 2021
PRIMARY 4**

SCIENCE

BOOKLET A

28 Multiple Choice Questions (56 marks)

Total Time for Booklets A and B : 1 hour 45 minutes

INSTRUCTIONS TO CANDIDATES

1. Write your name and index number in the space provided.
2. Do not turn over the page until you are told to do so.
3. Follow all instructions carefully.
4. Answer all questions.
5. Shade your answers in the Optical Answer Sheet (OAS) provided.

Marks Obtained

Booklet A		/56
Booklet B		/44
Total		/100

Name: _____ () **Class:** P 4S _____

Date : 11 May 2021

Parent's signature: _____

Section A: (28 x 2 marks = 56 marks)

For each question from 1 to 28, four options are given. One of them is the correct answer. Make your choice (1, 2, 3 or 4) and shade your answer on the Optical Answer Sheet.

- 1 Study the two pictures below.

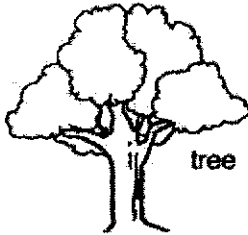

tree



deer

Which of the following statements correctly describes both living things?

- (1) Both cannot reproduce.
 - (2) Both reproduce from seeds.
 - (3) Both can make their own food.
 - (4) Both can respond to changes around them.
- 2 The pictures below show a tortoise and a crocodile.

tortoise

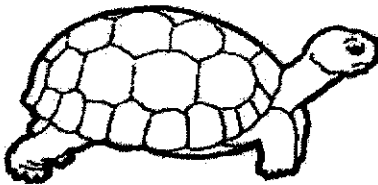

crocodile

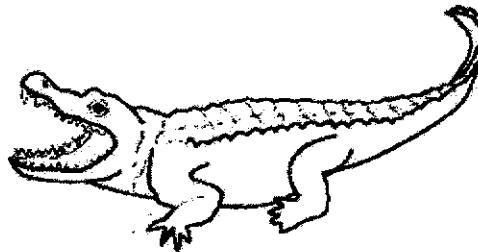

They are similar because they _____

- (1) have hair
- (2) have wings
- (3) have scales
- (4) are covered with feathers

3 Study the flow chart below.

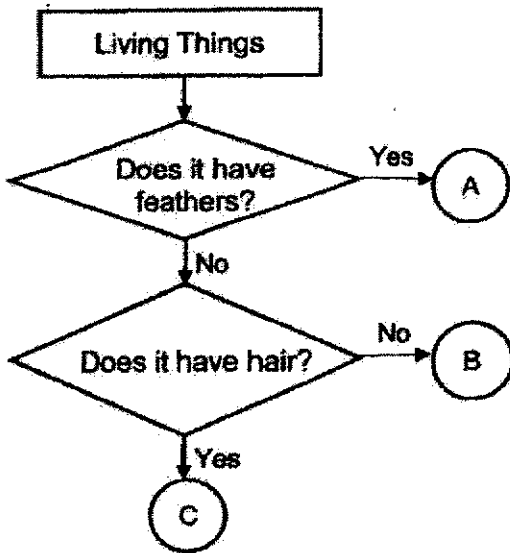

What could A, B and C be?

	A	B	C
(1)	bird	fish	mammal
(2)	bird	mammal	fish
(3)	mammal	fish	bird
(4)	mammal	bird	fish

4 Which of the following correctly identifies parts X, Y and Z of a plant?

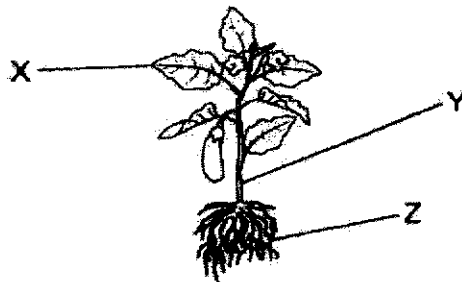

	X	Y	Z
(1)	leaf	root	stem
(2)	leaf	stem	root
(3)	root	stem	leaf
(4)	stem	leaf	root

5 Which of the following is **not** a function of the roots of a plant?

- (1) To take in water for a plant
- (2) To take in mineral salts for a plant
- (3) To hold a plant firmly to the ground
- (4) To support and keep a plant upright

6 Peter has two identical tanks of water plants. He kept one tank inside a glass box and another tank inside a cardboard box as shown below. Both boxes are of the same size.

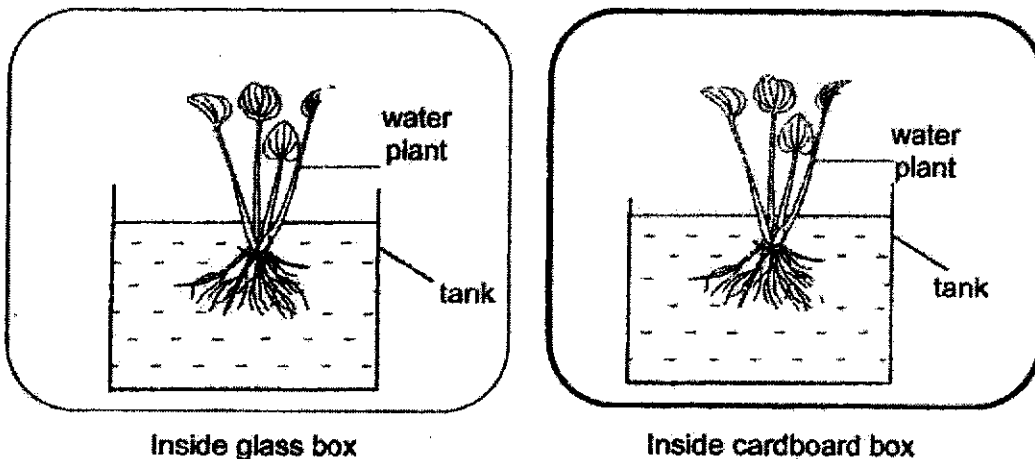

After one week, the water plant inside the cardboard box died but not the water plant inside the glass box.

Which statement(s) below explain(s) why the water plant in the cardboard box died?

Statement	
A	There is not enough air for the plant in the cardboard box.
B	There is not enough water for the plant in the cardboard box.
C	There is no mineral salts for the plant in the cardboard box.
D	There is no sunlight for the plant to make food in the cardboard box.

- (1) D only
- (2) A and D
- (3) A, C and D
- (4) All of the above

The diagram below shows the human digestive system.
Study the diagram below and answer questions 7 and 8.

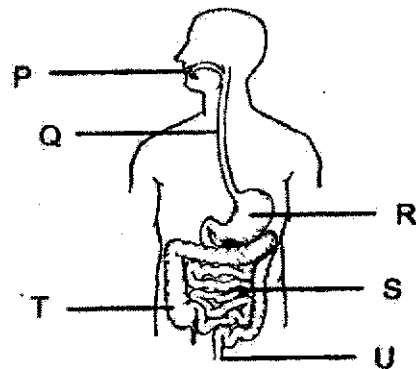

- 7 In which of the following labelled parts does digestion start and end?

	Start	End
(1)	P	S
(2)	P	U
(3)	Q	R
(4)	Q	T

- 8 Which of the following labelled parts produce digestive juices?

- (1) R, S and T only
 (2) P, R and S only
 (3) P, R, S and T only
 (4) P, Q, R and S only

- 9 Which of the following statements about organ W is true?

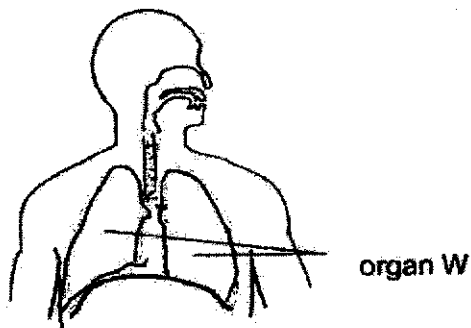

- (1) W protects the organs in our chest.
 (2) W takes in and removes air from our body.
 (3) W controls the movement of our body parts.
 (4) W carries digested food and water to all parts of our body.

- 10 The diagram below shows the stages in the life cycle of an animal.

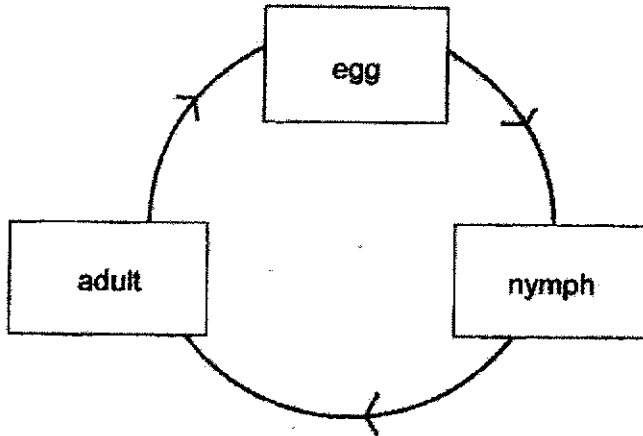

Which animal is likely to have the life cycle as shown above?

- (1) beetle
 (2) chicken
 (3) mosquito
 (4) grasshopper
- 11 Siti observed the young of a butterfly feeding on the leaves of a plant. Which stage is the young of the butterfly in?
- (1) egg
 (2) pupa
 (3) larva
 (4) nymph
- 12 The diagram below shows the growth of plant Z over time.

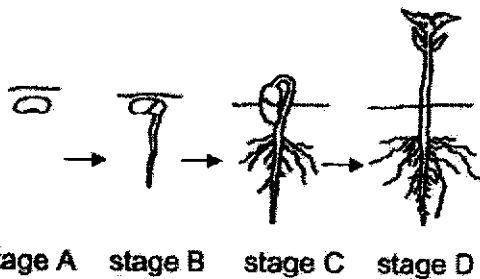

At which stage is plant Z able to make food?

- (1) A
 (2) B
 (3) C
 (4) D

- 13 The table below shows what a pupil had observed about the growth of an insect.

Date	Observation
6 Jan	Eggs were laid.
8 Jan	Eggs hatched into larvae.
12 Jan	Some larvae became pupae.
22 Jan	Some pupae became adult insects.

Based only on the information in the table above, which statement is not correct?

- (1) The adult insect laid many eggs.
- (2) The pupa stage comes after the larva stage.
- (3) The larvae hatched from the eggs the next day.
- (4) The insect spends most of its life as a pupa before becoming an adult.

- 14 The table below shows the properties of three materials, J, K, L and M. A tick (✓) shows that the material has the property and a cross (✗) shows that the material does not have the property.

Properties	Materials			
	J	K	L	M
It is flexible.	✗	✗	✓	✗
It is transparent.	✗	✓	✗	✗
It can float on water.	✓	✓	✗	✗

The diagram below shows a garden water hose.

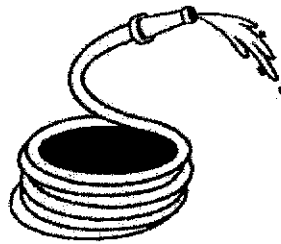

Which material, J, K, L or M, is the most suitable to make the garden water hose so that it can be coiled easily?

- (1) material J
- (2) material K
- (3) material L
- (4) material M

- 15 The diagram below shows a dining chair.

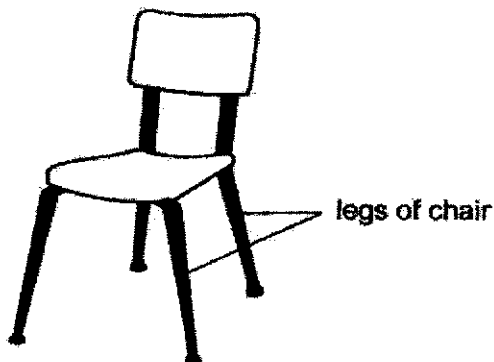

Metal is used to make the legs of the chair because it _____.

- (1) is bright
- (2) is strong
- (3) can bend
- (4) can sink in water

- 16 Kelly placed three different materials, A, B and C into three containers which have the same amount of water. After two minutes, she removed the three materials.

The amount of water left in the containers is shown below.

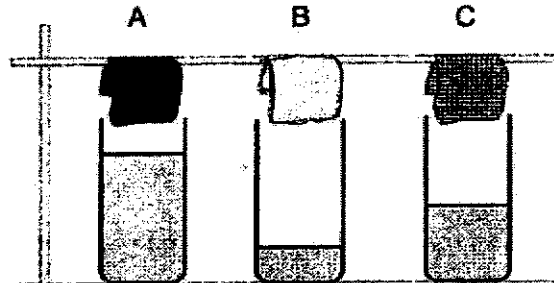

Which one of the following shows the correct order of the materials starting with the one that absorbs the most water?

	Absorbs most water	—————→	Absorbs least water
(1)	A	B	C
(2)	A	C	B
(3)	B	C	A
(4)	B	A	C

- 17 Which of the following statements about magnets is not correct?

- (1) Unlike poles of magnets attract when facing each other.
- (2) The magnetic strength of a magnet is strongest at its poles.
- (3) A magnet obtained by the stroke method is a temporary magnet.
- (4) A freely suspended bar magnet will come to rest in the East-West direction.

- 18 Two plastic toy cars are placed on the table. Each car is glued to a magnet. Ali held another magnet in between the two toy cars as shown below.

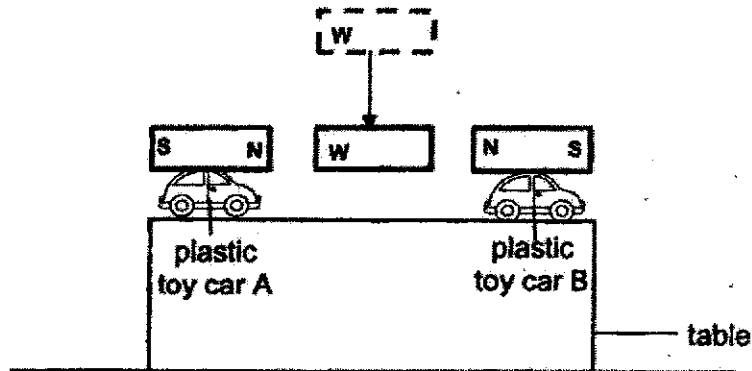

If W is the North pole of the magnet, what will most likely happen to toy car A and toy car B?

	Toy Car A	Toy Car B
(1)	It will be attracted to Ali's magnet.	It will be knocked off the edge of the table.
(2)	It will be attracted to Ali's magnet.	It will be attracted to Ali's magnet.
(3)	It will be knocked off the edge of the table.	It will be knocked off the edge of the table.
(4)	It will be knocked off the edge of the table.	It will be attracted to Ali's magnet.

- 19 Amy has a bar magnet as shown below. She wants to attract some steel clips in a plastic tray.

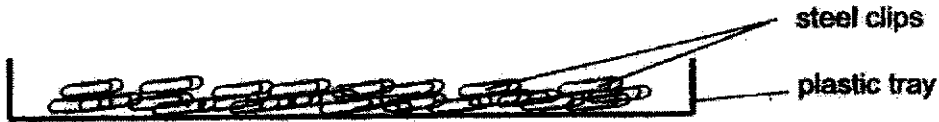

Which of the following shows the likely results for the number of steel clips attracted by parts W, X and Y of the bar magnet?

	W	X	Y
(1)	0	0	0
(2)	4	10	4
(3)	9	4	10
(4)	10	9	4

- 20 Study the arrangements of 3 bar magnets as shown below. Which arrangement is correct?

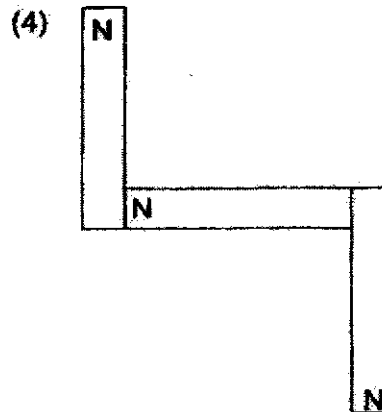
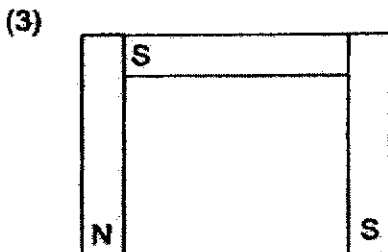
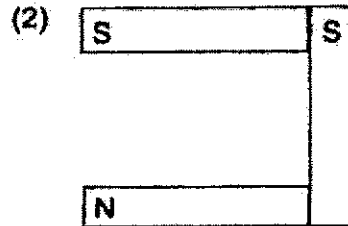
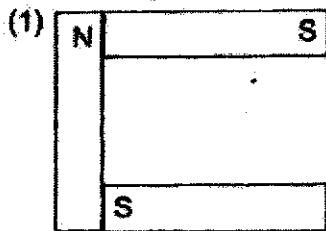

- 21 An object can be seen when it (i) _____ light or when it is a (ii) _____ of light.

	(i)	(ii)
(1)	blocks	source
(2)	blocks	beam
(3)	reflects	beam
(4)	reflects	source

- 22 Shamilee shone a torchlight at different directions on a set-up made of ceramic and observed two shadows formed as shown below.



Which of the following was the set-up which Shamilee had shone the torch on?

(1)



(2)



(3)



(4)



- 23 Mr Tham set up an experiment in a dark room as shown below.

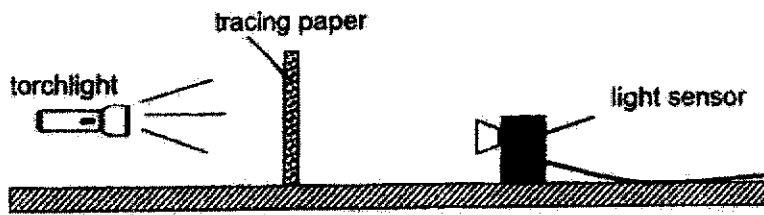

He added more pieces of tracing paper, one sheet at a time, between the torchlight and the light sensor. The amount of light passing through the paper was measured by the light sensor.

Which of the following graphs shows the result of his experiment?

(1)

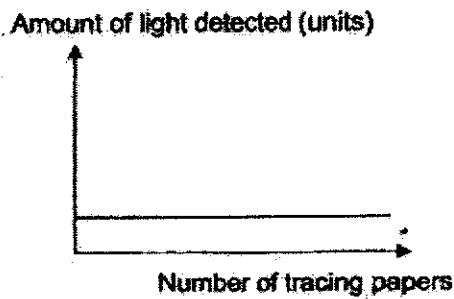

(2)

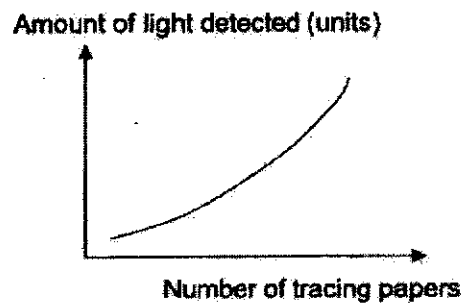

(3)

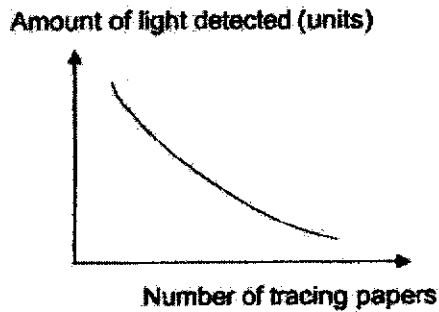

(4)

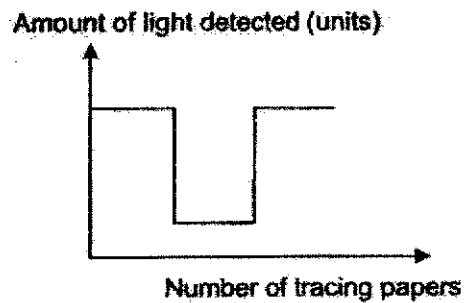

- 24 Study the set-up below. Three identical metal balls were placed at different positions between a torchlight and a screen.

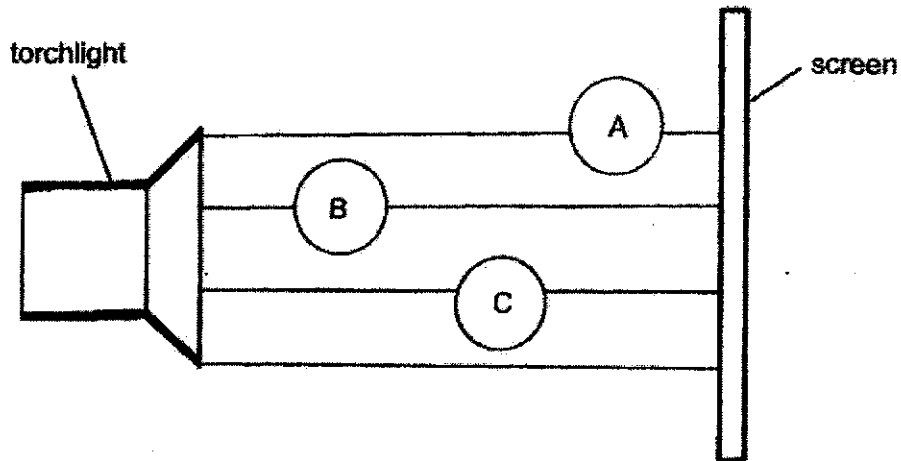

Three shadows were cast on the screen.

Which of the following correctly arranges the shadow sizes of metal balls A, B and C?

	Largest shadow \longrightarrow Smallest shadow		
(1)	A	B	C
(2)	A	C	B
(3)	B	A	C
(4)	B	C	A

- 25 Which of the following is not matter?

- (1) milk
- (2) music
- (3) marble
- (4) magnet

26 Ali pumps air into a flat soccer ball as shown below

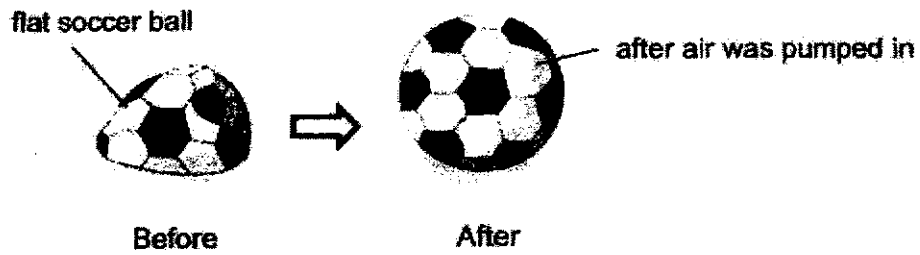

Which of the following is correct about the changes to the soccer ball after air was pumped in?

	Shape	Mass	Volume
(1)	changed	increased	decreased
(2)	changed	same	decreased
(3)	changed	increased	increased
(4)	same	decreased	increased

27 Study the flowchart below.

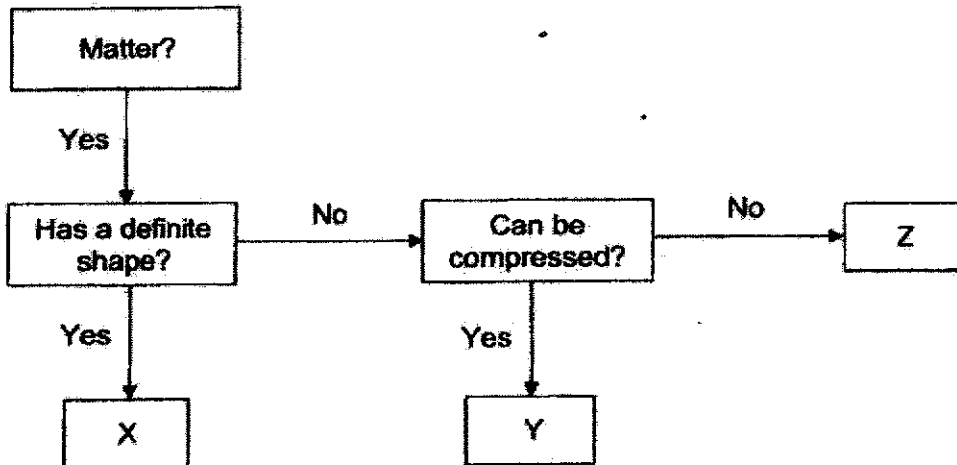

Identify the state of matter that X, Y and Z are in.

	Solid	Liquid	Gas
(1)	X	Y	Z
(2)	X	Z	Y
(3)	Y	Z	X
(4)	Z	X	Y

- 28 Feliss placed some marbles inside a beaker to the 45 cm^3 mark. She then poured some water into the beaker up to the 100 cm^3 mark as shown below.

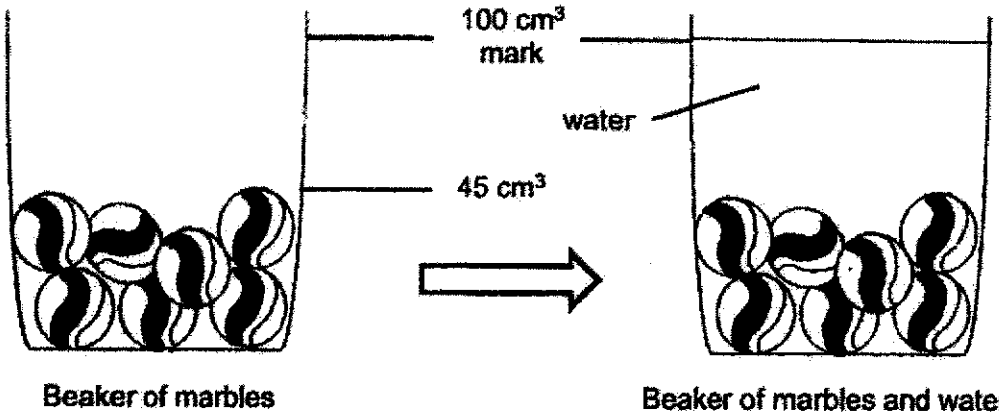

Which of the following is most likely the amount of water Feliss has poured into the beaker?

- (1) 45 cm^3
- (2) 55 cm^3
- (3) 65 cm^3
- (4) 100 cm^3



**NAN HUA PRIMARY SCHOOL
MID-YEAR EXAMINATION 2021
PRIMARY 4**

SCIENCE

BOOKLET B

12 Open-ended questions (44 marks)

Total Time for Booklets A and B : 1 hour 45 minutes

INSTRUCTIONS TO CANDIDATES

1. Write your name and index number in the space provided.
2. Do not turn over the page until you are told to do so.
3. Follow all instructions carefully.
4. Answer all questions.
5. Write your answers in this booklet.

Marks Obtained

Section B	/ 44
------------------	-------------

Name: _____ () **Class:** P 4S _____

Date : 11 May 2021

Parent's Signature: _____

Section B: (44 marks)

Write your answers to questions 29 to 40.

The number of marks available is shown in brackets [] at the end of each question or part question.

29 The pictures below show two animals, S and T.

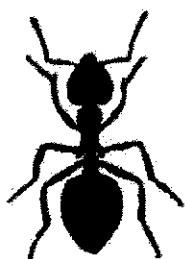

animal S



animal T

(a) State the animal group that animal T belong to. [1]

Animal T : _____

(b) Based only on what you can observe from the pictures above, state two characteristics observed that shows animal S is an insect. [2]

(i) _____

(ii) _____

(c) State the outer covering of animal T that enables it to breathe in water. [1]

Score	4
-------	---

30 Peishi conducted an experiment in a classroom as shown below. She measured the water level in each set-up after two days.

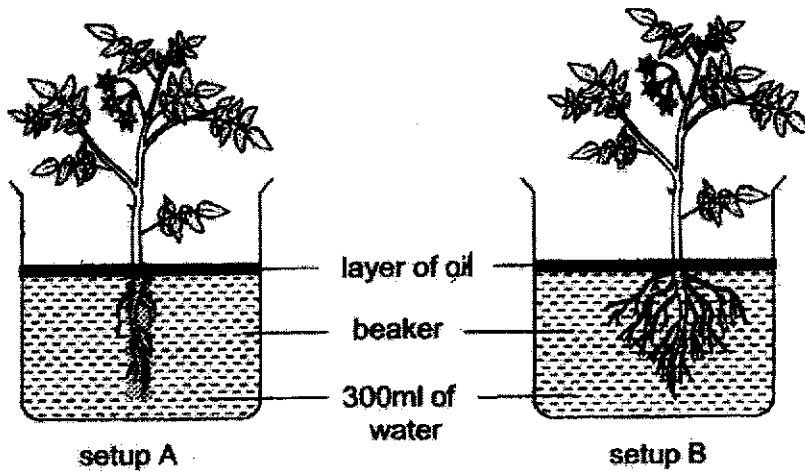

(a) What is the aim of Peishi's experiment? Put a tick in the correct box. [1]

Aim statement		Tick (✓)
(i)	To find out if the layer of oil affects the water level in the set-ups.	<input type="checkbox"/>
(ii)	To find out if the number of leaves affects the water level in the set-ups.	<input type="checkbox"/>
(iii)	To find out if the amount of roots affects the water level in the set-ups.	<input type="checkbox"/>

(b) In which set-up, A or B, will the water level be lower after two days? Explain your answer. [2]

Score	3
-------	---

- 31 The diagram below shows two samples of undigested food, P and Q. One sample was taken from the stomach and the other sample was taken from the mouth of the same person.

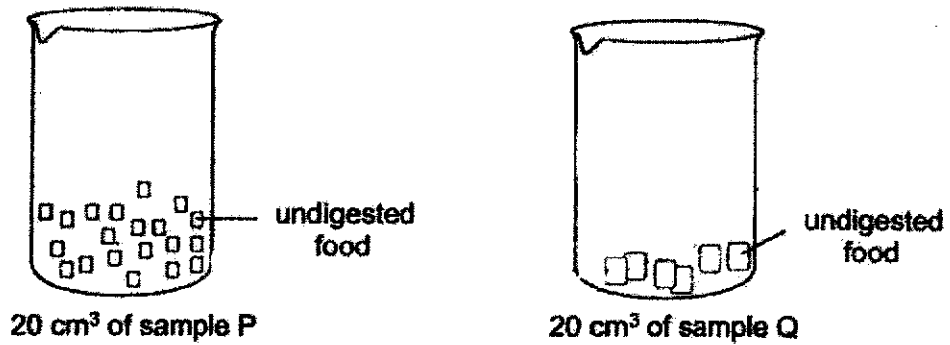

- (a) Which sample of undigested food, P or Q, was taken from the mouth? Give a reason for your answer. [2]

- (b) Macy poured an equal amount of digestive juices into sample P and sample Q. In which sample, P or Q, will the undigested food be broken down faster? Explain your answer. [2]

Score	4
-------	---

32 The diagram below shows the life cycles of animal X and animal Y respectively..

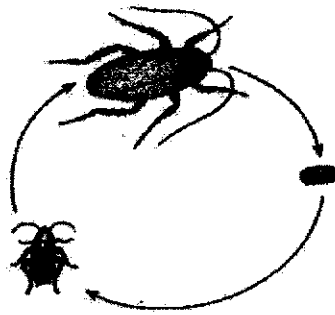

Life cycle of animal X

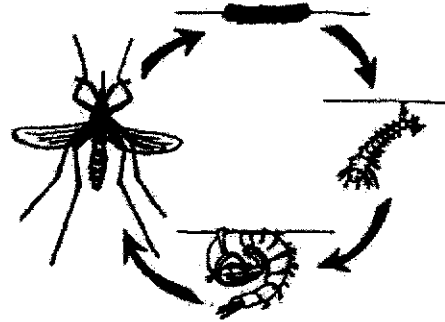

Life cycle of animal Y

(a) Based on the diagrams above, state two differences between the life cycle of animal X and the life cycle of animal Y. (Do not name the stages present.) [2]

(i) Difference 1 : _____

(ii) Difference 2 : _____

(b) Based only on the life cycles shown above, state the two characteristics of living things. [2]

(i) Characteristic 1 : _____

(ii) Characteristic 2 : _____

Score	4
-------	---

- 33 Study the classification chart below and answer the questions that follow.

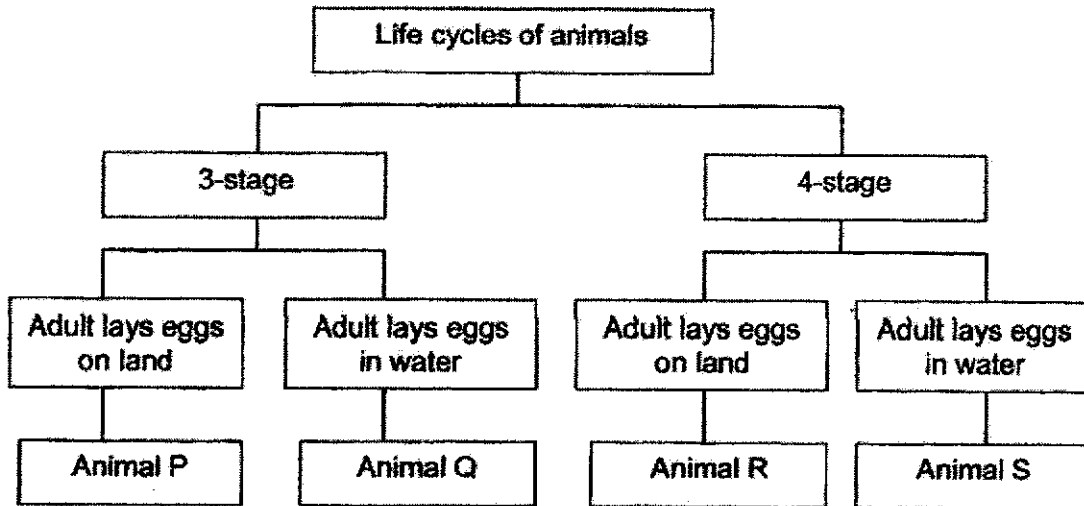

- (a) Based on the classification chart above, what are the two characteristics of animal P? [1]

- (b) Based on the classification chart above, state a similarity between animal Q and animal S. [1]

- (c) Match the animals below with the animals described in the classification chart. [2]

Chicken : animal _____

Frog : animal _____

Score	4
-------	---

- 34 Max wanted to find out how much light could pass through four different materials, W, X, Y and Z. The amount of light that passed through each material was measured using a light sensor as shown in the graph below.

Amount of light detected (units)

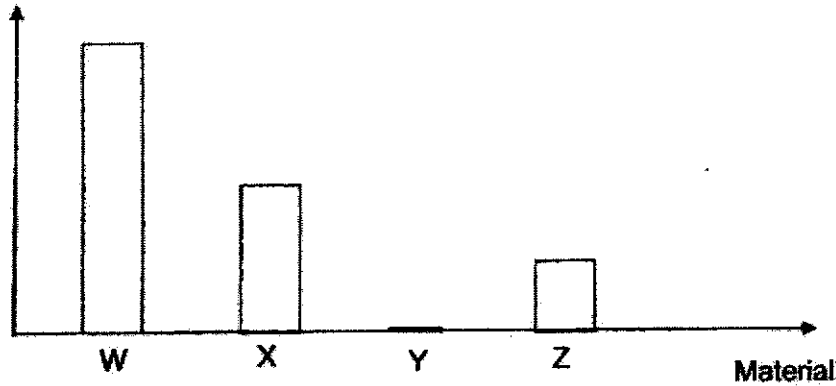

- (a) Arrange the four materials, W, X, Y and Z, according to the degree of transparency as shown below. [2]

Allow most light to pass through



Allow least light to pass through

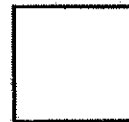

- (b) Explain why material Y is suitable to make the door of a changing room. [2]

Score	4
-------	---

- 35 Roy wanted to find out if he could make an iron bar into a temporary magnet. He used the North pole of a bar magnet to stroke the complete length of the iron bar three times in the direction as shown below.

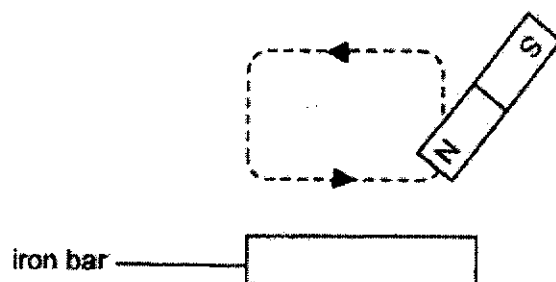

- (a) No steel clips were attracted to the iron bar after stroking. Without changing the bar magnet, what can Roy do to increase the number of paper clips attracted to the iron bar? [1]

- (b) Name another method to make the iron bar into a magnet. [1]

Score	2
-------	---

- 36 Sue set up an experiment to find out whether the number of batteries in a circuit will affect the strength of an electromagnet as shown below.

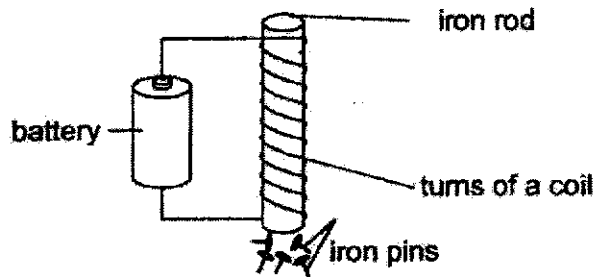

She recorded the number of iron pins attracted by the electromagnet.

Number of batteries	Number of iron pins attracted
1	4
2	8
3	11
4	16

- (a) Based on the results shown, what is the relationship between the number of batteries and the strength of the electromagnet? Explain your answer. [2]

- (b) State two variables that Sue had to keep the same when conducting this experiment. [2]

(i) _____

(ii) _____

Score	4
-------	---

37 Mike was walking in a straight line from point A to point B to point C. He saw a cat in front of him.

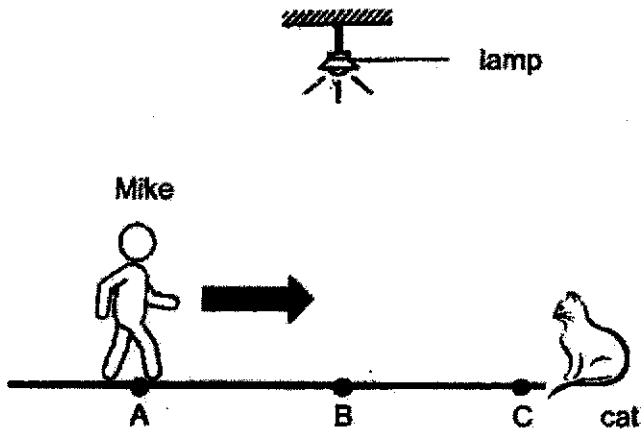

(a) Based on the diagram above, explain how is Mike able to see the cat. [1]

(b) Describe how Mike's shadow changes in length as he walks from point A to point B and then to point C. [2]

(c) Mike noticed the shadow of the cat on the floor. Explain how the cat's shadow is formed. [1]

Score	4
-------	---

- 38 Adele set up the experiment below. A metal sheet with a rectangular cut-out was placed between a screen and a torch.

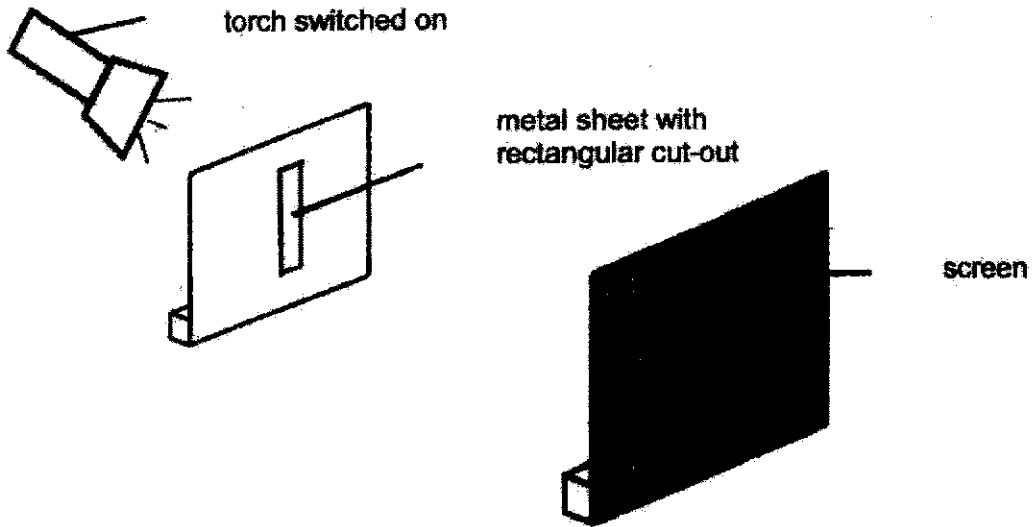

She observed a bright rectangle surrounded by dark shadow on the screen.

- (a) What is the relationship between the distance of the metal sheet from the torch and the size of the shadow on the screen? [1]

- (b) Without moving the metal sheet, what can she do to make the bright rectangle on the screen smaller? [1]

Score	2
-------	---

- (c) Another metal sheet with a circular cut-out was placed in the setup as shown below.

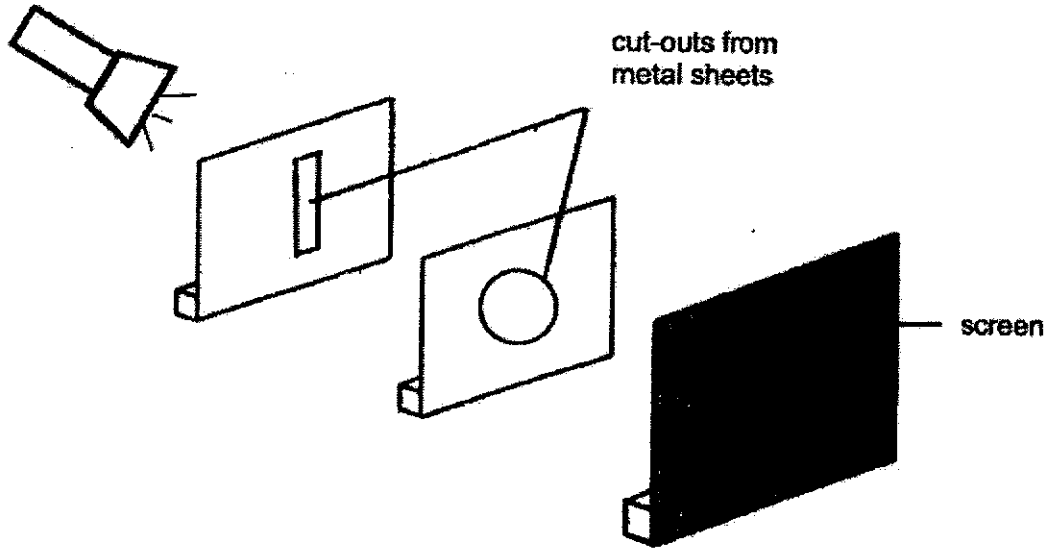

In the diagram given below, shade the shadow as how it would be seen on the screen. [1]

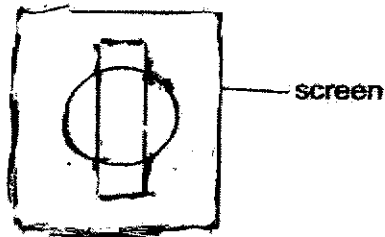

Score	1
-------	---

39 Mrs Mah placed three different objects, A, B and C, on a lever balance as shown below.

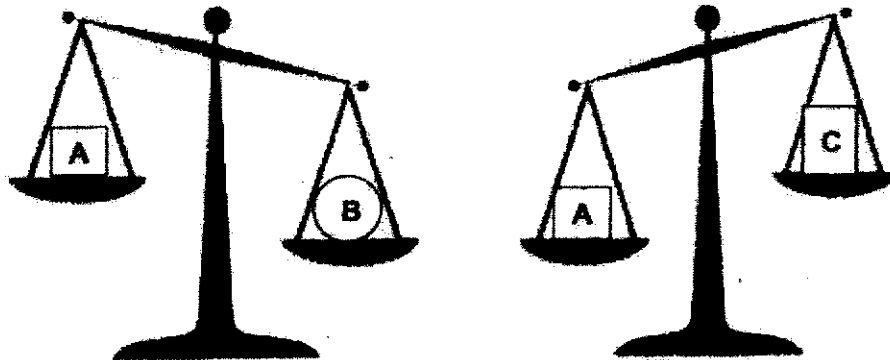

(a) Write **True** or **False** beside each statement below. [2]

	Statement	True / False
(i)	A lever balance is used to measure volume.	
(ii)	Object A has a greater mass than object C, but a lesser mass than object B.	

In another experiment, Mrs Mah placed object B into a beaker that was filled to the brim with 100 cm³ of water. 60 cm³ of water overflowed from the beaker.

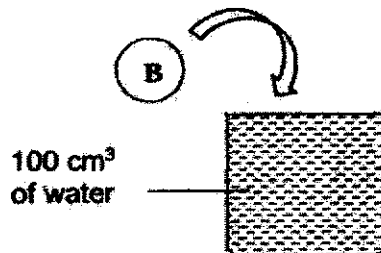

(b) What is the volume of object B? [1]

(c) Fill in the blank below with a suitable word. [1]

The volume of object B can be found because it does not absorb water and it _____ when lowered into water.

Score	4
-------	---

40. Yuhan poured some water from a beaker into a flask as shown below.

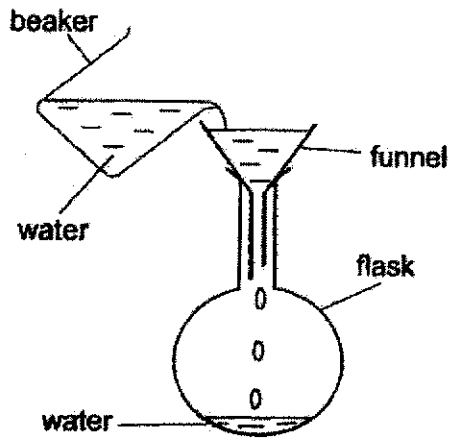

At first, the water could flow into the flask quickly. After a while, she noticed that the flow of water has slowed down and stopped eventually.

(a) Explain why the water from the funnel flowed very slowly and eventually stopped flowing into the flask. [2]

(b) What would happen to the mass and volume of the air inside the flask when water is poured into it? Please tick (✓) in the correct box(es) below. [1]

	Increased	Decreased	Remained the same
Mass of air in flask			
Volume of air in flask			

Score	3
-------	---

- (c) Without adding or removing any items from the set-up, suggest how Yuhan can make the water flow faster into the flask. [1]

Score	1
-------	---

SCHOOL : NAN HUA PRIMARY SCHOOL
LEVEL : PRIMARY 4
SUBJECT : SCIENCE
TERM : SA 1

Booklet A

Q1	Q2	Q3	Q4	Q5	Q6	Q7	Q8	Q9	Q10
4	3	1	2	4	1	1	2	2	4
Q11	Q12	Q13	Q14	Q15	Q16	Q17	Q18	Q19	Q20
3	4	3	3	2	3	4	4	3	2
Q21	Q22	Q23	Q24	Q25	Q26	Q27	Q28		
4	4	3	4	2	3	2	3		

Booklet B

Q29	<ul style="list-style-type: none"> a) Animal T: Amphibians b) i) Animal S has six legs ii) Animals has three body parts c) *tick (iii)*
Q30	<ul style="list-style-type: none"> a) Set-up B. There is more roots to absorb water, but in set-up A, there are lesser roots and cannot absorb as much water as the plants in set-up B., Thus, the water level will be lower in setup B.
Q31	<ul style="list-style-type: none"> a) Sample Q. The food in sample Q is in smaller pieces, which means it has been churned by other digestive juices and it has gone for further digestion, but sample Q has not gone for further digestion. b) Sample P. When Sample P is broken down into smaller pieces, there will be more surface area for the digestive juice to act on making Sample P able to be broken down faster.
Q32	<ul style="list-style-type: none"> a) Difference 1: Animal has three stages in its life cycle while Animal Y has 4 stages in its life cycle Difference 2: The young of Animal X resemble it's adult but the young of animal Y does not resemble it's adult. b) Characteristic 1: Living things can reproduce Characteristic 2: Living thing scan grow
Q33	<ul style="list-style-type: none"> a) Animal P has 3-stage life cycle and lays eggs on land. b) Both adult lay eggs in water c) Animal P d) Animal Q
Q34	<ul style="list-style-type: none"> a) W----X----Z----Y b) It allows the least light to pass through, making it most difficult for someone to see through the door.
Q35	<ul style="list-style-type: none"> a) He can stroke the iron bar more times b) Electrical method

Q36	<p>a) As the number of batteries increases, the number of iron pins attracted to the magnet also increases, more coils added to the batteries also can help to increase the number of pins attracted by the electromagnet</p> <p>b) i) The type of iron pins ii) The type of batteries</p>
Q37	<p>a) The light from the lamp reflects off the cat and into his eyes.</p> <p>b) The shadow will decrease in length as he walks from point A to B and increase again when walking to point C.</p> <p>c) The cat blocks the path of light from the lamp, forming a shadow.</p>
Q38	<p>a) As the distance between the metal sheet and the torch increases, the size of the shadow decreases.</p> <p>b) Move the screen nearer from the metal sheet.</p> <div data-bbox="507 712 678 896" style="text-align: center;"> </div> <p>c)</p>
39	<p>a) i) False ii) True</p> <p>b) 60 cm^3</p> <p>c) Sinks</p>
40	<p>a) The air inside the flask took up space and could not escape. There are solid particles stuck in between the funnel and cannot go to the flask.</p> <p>b) Remained the same ✓ Decreases ✓</p> <p>c) Lift the funnel up</p>