



NANYANG PRIMARY SCHOOL

PRIMARY 4 SCIENCE

**MID-YEAR EXAMINATION
2021**

BOOKLET A

Total duration for Booklets A and B: 1 h 45 min

Name: _____ ()

Class: Primary 4 ()

**DO NOT OPEN THIS BOOKLET UNTIL YOU ARE TOLD TO DO SO.
FOLLOW ALL INSTRUCTIONS CAREFULLY.**

Booklet A consists of 16 printed pages including this cover page.

Section A: Multiple Choice Questions [56 marks]

For each question from 1 to 28, four options are given. One of them is the correct answer. Indicate your choice in this booklet and shade the correct oval (1, 2, 3 or 4) on the Optical Answer Sheet provided.

1. Study the classification table below.

X	Y
sunflower	beetle
rose plant	bird
bird's nest fern	grasshopper

Which of the following best represents X and Y?

	X	Y
(1)	living things	non-living things
(2)	flowering plants	non-flowering plants
(3)	make its own food	looks for its own food
(4)	able to move on its own	unable to move on its own

2. The diagram below shows two living things, P and Q.

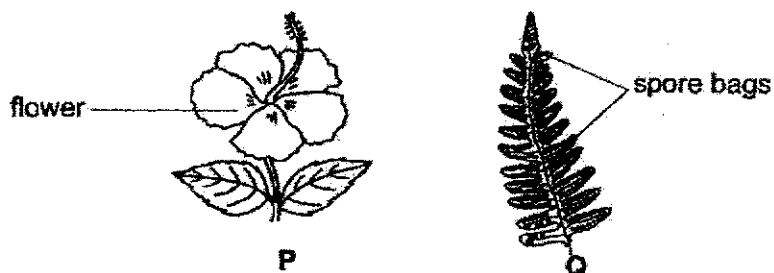

Which of the statements describe the similarities between living things P and Q?

- A Both can bear flowers.
 B Both need water to survive.
 C Both reproduce from spores.
 D Both are able to make their own food.

- (1) A and C only
 (3) B and C only

- (2) A and D only
 (4) B and D only

3. Four ~~Three~~ children each made a statement about reptiles.

Mary: They have three body parts.

Caleb: They reproduce by laying eggs.

Javier: They are found on land and in water.

Emma: They have dry scales as their outer covering.

Who had made a **wrong** statement about reptiles?

- (1) Mary
 (2) Caleb
 (3) Javier
 (4) Emma
4. Which one of the following, A, B, C or D, best represents an amphibian?

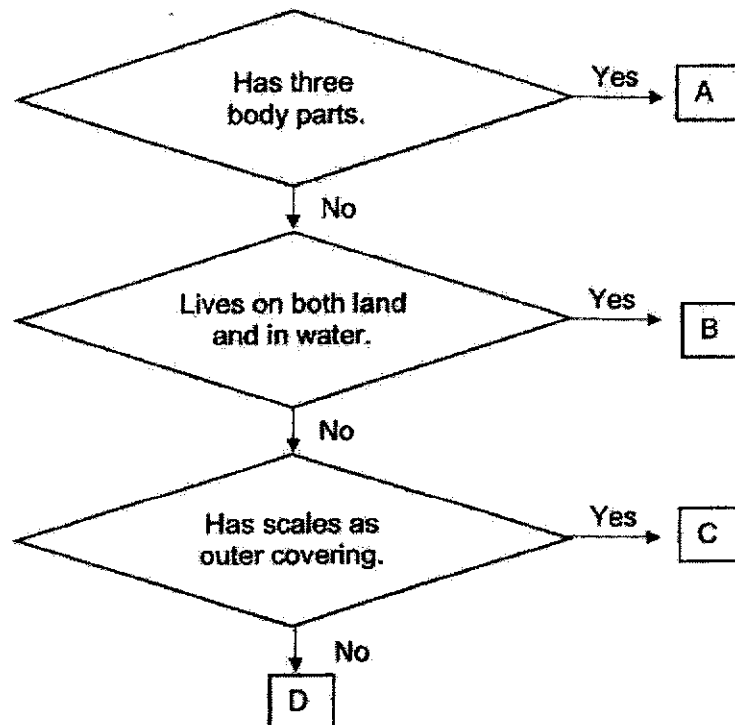

- (1) A
 (2) B
 (3) C
 (4) D

Study the diagram below and answer Questions 5 and 6.

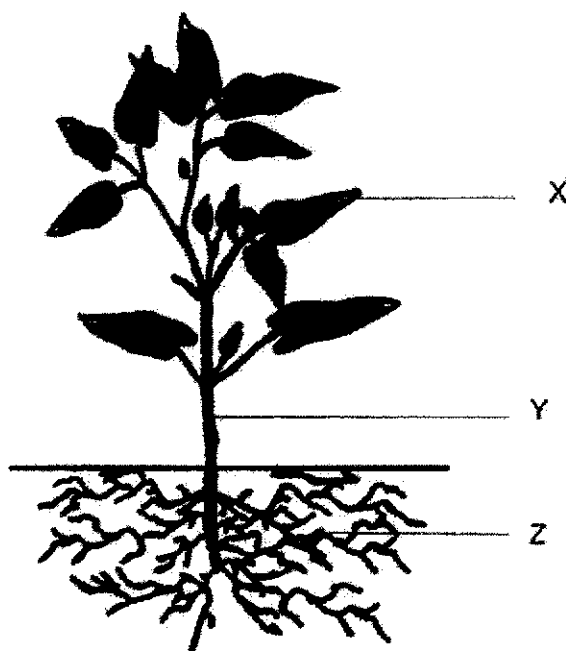

5. Which one of the following correctly represents plant parts X, Y and Z?

	X	Y	Z
(1)	leaf	stem	root
(2)	leaf	root	stem
(3)	stem	leaf	root
(4)	stem	root	leaf

6. Which one of the following statements is wrong?

- (1) Part X makes food for the plant.
- (2) Part Y takes in and gives out gases.
- (3) Part Z holds the plant firmly to the ground.
- (4) Parts X, Y and Z work together to help the plant stay alive.

7. The diagram below shows Plants C and D.

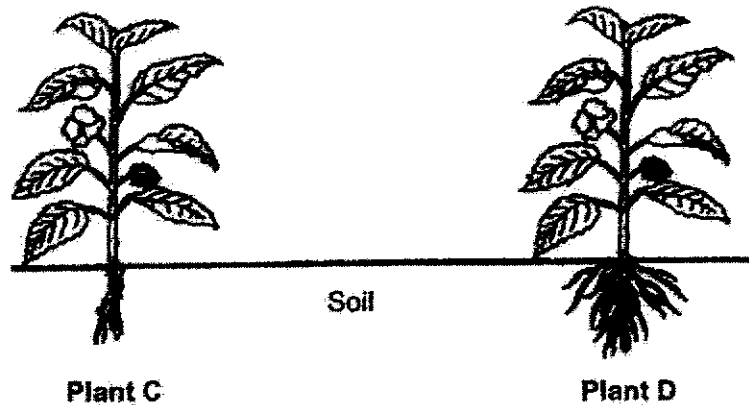

Which one of the following statements about plants C and D is correct?

- (1) Plant D is taller than Plant C.
 - (2) Plant C has more leaves than Plant D.
 - (3) Plant C has more flowers than Plant D.
 - (4) Plant D is held more firmly to the ground than Plant C.
8. Sam conducted an experiment with a similar plant in set-up E and set-up F. The table below shows the conditions present in each set-up.

Conditions	Set-up E	Set-up F
Amount of water given daily	10ml	0ml
Amount of soil	200g	200g
Presence of sunlight	Yes	Yes
Presence of air	Yes	Yes

Sam recorded the height of the plant daily for 7 days. What was Sam trying to find out?

- (1) To find out if plants need air to grow well.
- (2) To find out if plants need soil to grow well.
- (3) To find out if plants need water to grow well.
- (4) To find out if plants need sunlight to grow well.

9. Study the organ system shown below. The diagram below shows the organs of several systems of the human body.

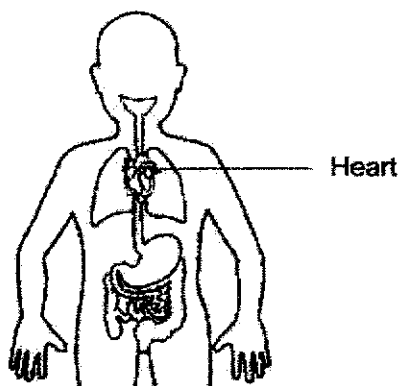

Which organ system does the heart belong to?

- (1) Muscular system
 (2) Digestive system
 (3) Circulatory system
 (4) Respiratory system
10. Which one of the following human organ system is wrongly matched to its main function?

	Organ System	Main Function
(1)	Skeletal	Gives the body shape.
(2)	Muscular	Helps different parts of the body to move.
(3)	Circulatory	Removes air from the body.
(4)	Respiratory	Takes in air into the body.

11. The following statements describe the process of digestion.

- A Digested food is absorbed into the blood.
- B Excess water is absorbed from the undigested food.
- C Partially digested food is further broken down into simpler substances.
- D Food is chewed into smaller pieces.

Which of the following shows the correct sequence during digestion?

- (1) D → A → B → C
- (2) D → A → C → B
- (3) D → C → A → B
- (4) D → C → B → A

12. The bar graph below shows the amount of undigested food X present in some organs found in Amy's digestive system. There were 100 units of undigested food X at the start.

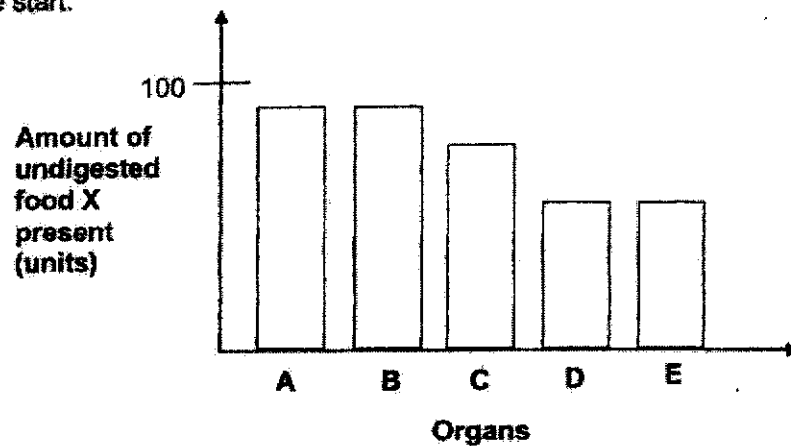

Which organ does C represent?

- (1) mouth
- (2) gullet
- (3) stomach
- (4) small intestine

13. Andrea attached a magnet on top of each toy car as shown below.

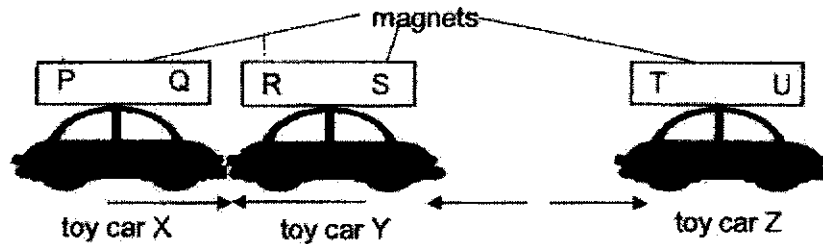

When toy car X was brought close to toy car Y, toy car Y moved towards it. Then she brought toy car Z near to toy car Y. She realised that toy car Z moved away from toy car Y.

Based on Andrea's observations, which of the following statements about the magnets is/are correct?

- A Pole R is attracted to Pole Q.
- B Pole P and Pole U are like poles.
- C Pole S and Pole T are unlike poles.

- (1) A only
 - (2) C only
 - (3) A and B only
 - (4) B and C only
14. Annie wanted to compare the magnetic strength of 4 magnets, C, D, E and F. The magnets are of the same size. She set up the experiment below and observed the number of steel pins that were attracted by each magnet.

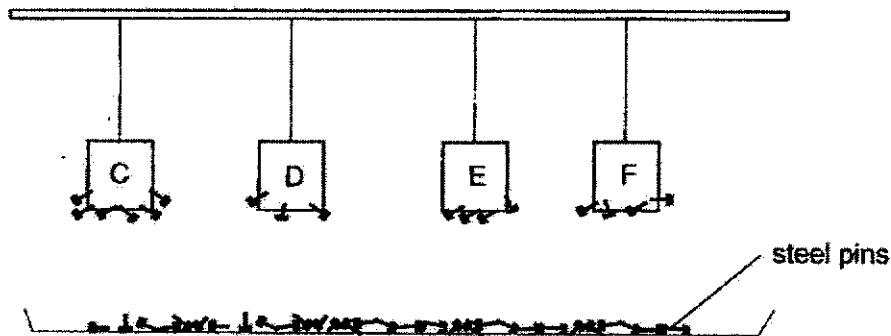

Based on the results above, which one of the following statements is correct?

- (1) Magnet E has the weakest magnetic strength.
- (2) Magnet D has the strongest magnetic strength.
- (3) Magnet F has a weaker magnetic strength than magnet D.
- (4) Magnet C has a stronger magnetic strength than magnet F.

15. Renee wanted to find out how the number of batteries will affect the strength of an electromagnet. She used identical wires, nails and batteries in her experiments as shown below.

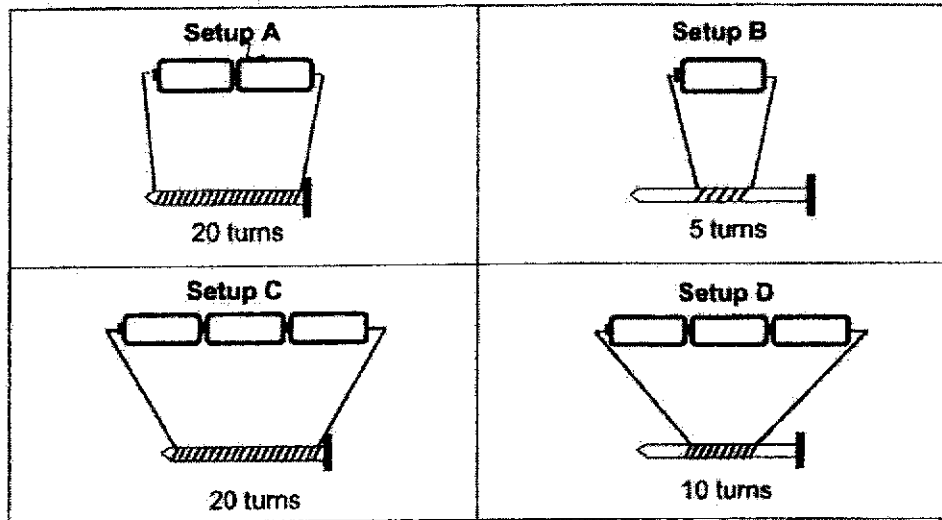

Which two setups should she use to conduct a fair test?

- | | |
|-------------------------------------------------|-------------------------------------------------|
| <p>(1) A and B only</p> <p>(3) B and D only</p> | <p>(2) A and C only</p> <p>(4) C and D only</p> |
|-------------------------------------------------|-------------------------------------------------|
16. Which of the following is/are source(s) of light?
- | | |
|--------------------------------------------------|----------------------------------------------------|
| <p>A Sun</p> <p>B mirror</p> <p>C lit candle</p> | |
| <p>(1) A only</p> <p>(3) B and C only</p> | <p>(2) A and C only</p> <p>(4) A, B and C only</p> |

17. Study the classification chart below.

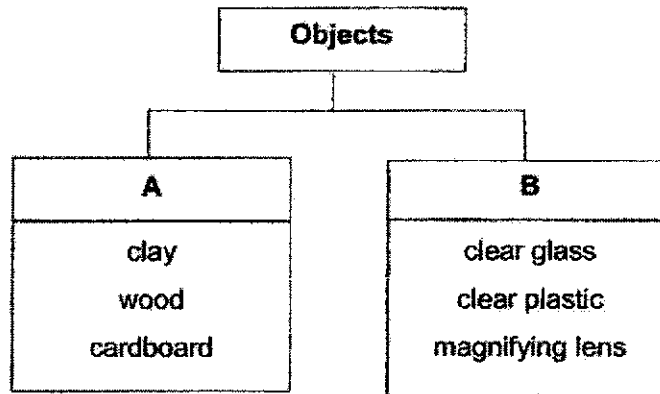

Which one of the following best represents A and B?

	A	B
(1)	Allows most light to pass through	Allows some light to pass through
(2)	Does not allow light to pass through	Allows most light to pass through
(3)	Allows some light to pass through	Does not allow light to pass through
(4)	Allows most light to pass through	Does not allow light to pass through

18. On a dark night, Weili walked from point A to D under a lighted street lamp as shown in the diagram below. The street lamp was at point B.

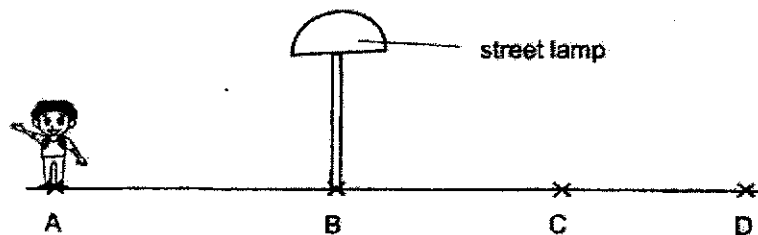

He noticed that the length of his shadow was different when he walked from point A to D. At which point A, B, C or D will his shadow be the shortest?

- (1) A
 (2) B
 (3) C
 (4) D

19. Chara cut out the following shapes from two identical cardboard sheets as shown below. The two sheets were of the same size.

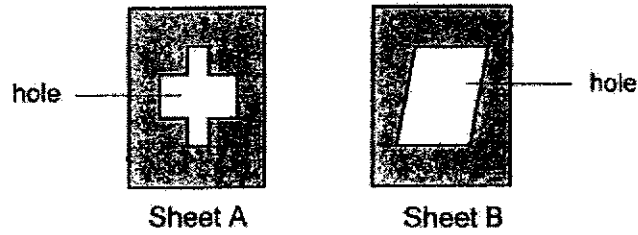

Front view of cardboard sheets

She then placed Sheet A at position X, a metal sheet at position Y and sheet B at position Z as shown below.

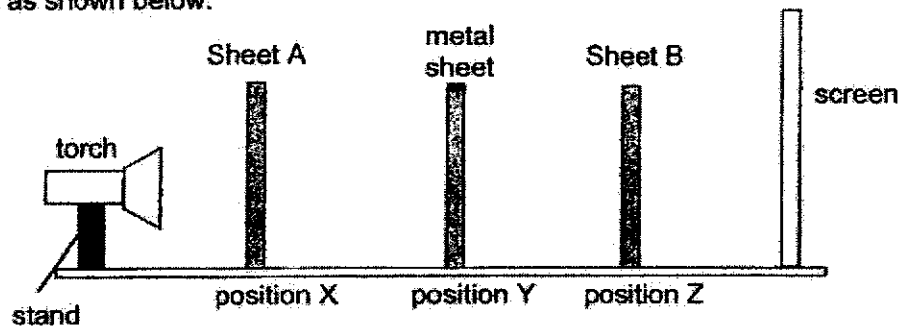

Which one of the following would be the shadow cast on the screen?

(1)

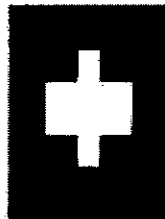

(2)



(3)



(4)



20. Marcus shone a torch at a pear as shown in the diagram below. It cast a shadow of the pear on the screen as shown in the diagram below.

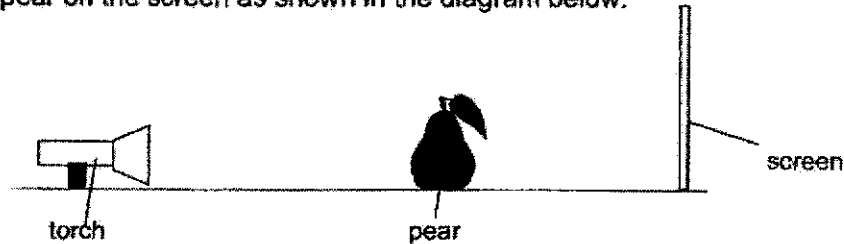

Which one of the following changes should he make to observe a smaller shadow on the screen?

- (1) Use a larger screen.
 - (2) Put the pear nearer to the torch.
 - (3) Put the pear further away from the torch.
 - (4) Put the pear further away from the screen.
21. The diagram below shows a construction worker wearing a safety vest which helps drivers see him when he works along the road.

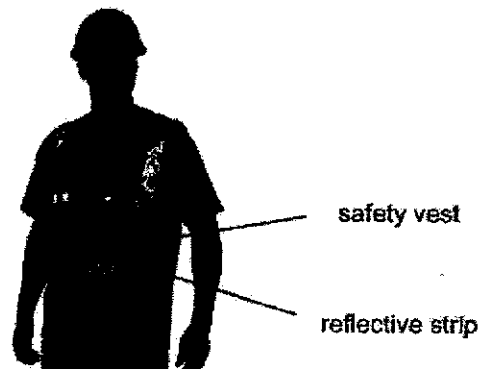

Which one of the following best explains how drivers are able to see the construction worker when he wears a safety vest at night?

- (1) The reflective strip gives off light on its own.
- (2) The reflective strip allows light to pass through it.
- (3) The reflective strip does not allow light to pass through it.
- (4) The reflective strip reflects light from the cars back into the driver's eyes.

22. Three triangles, A, B and C, were placed between three identical torches and a screen as shown in Diagram 1. Diagram 2 shows what Suli observed when the torches were switched on.

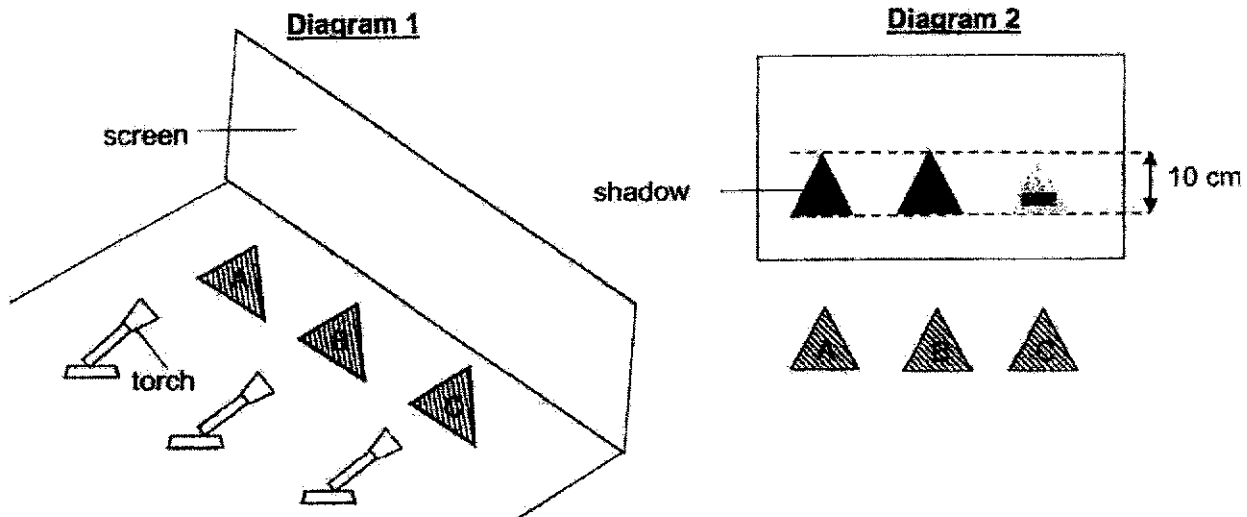

Based on the shadows cast on the screen, what could Suli conclude about triangles A, B and C?

- (1) A allows more light to pass through than C.
 - (2) B allows more light to pass through than C.
 - (3) B allows less light to pass through than A.
 - (4) C allows less light to pass through than A.
23. Study the classification table below.

A	B
rock bottle water	oxygen carbon dioxide air

Based on the classification table above, which one of the following best represents A and B?

- | | A | B |
|-----|-------------------------------|-----------------------------|
| (1) | Solid | Gas |
| (2) | Do not have a definite volume | Have a definite volume |
| (3) | Cannot be compressed | Can be compressed |
| (4) | Have mass and volume | Do not have mass and volume |

26. Study the flowchart below.

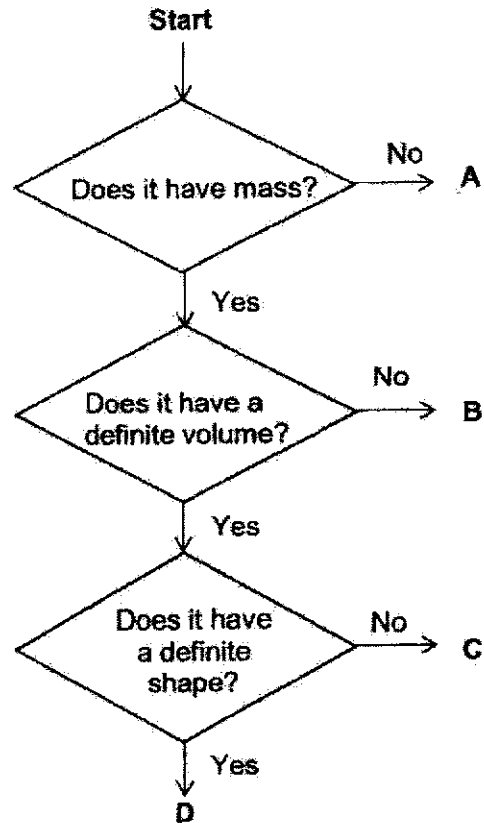

Which one of the following correctly represents items A, B, C and D?

	A	B	C	D
(1)	air	water	glass	sound
(2)	sound	air	water	glass
(3)	water	air	sound	glass
(4)	sound	water	glass	air

27. Ahmad conducted an experiment using a clear plastic cup with a hole. He pasted a wooden block at a fixed position in the cup. The cup was then pushed into a basin of water. Which one of the diagrams correctly shows the water level in the plastic cup when it was pushed into the water?

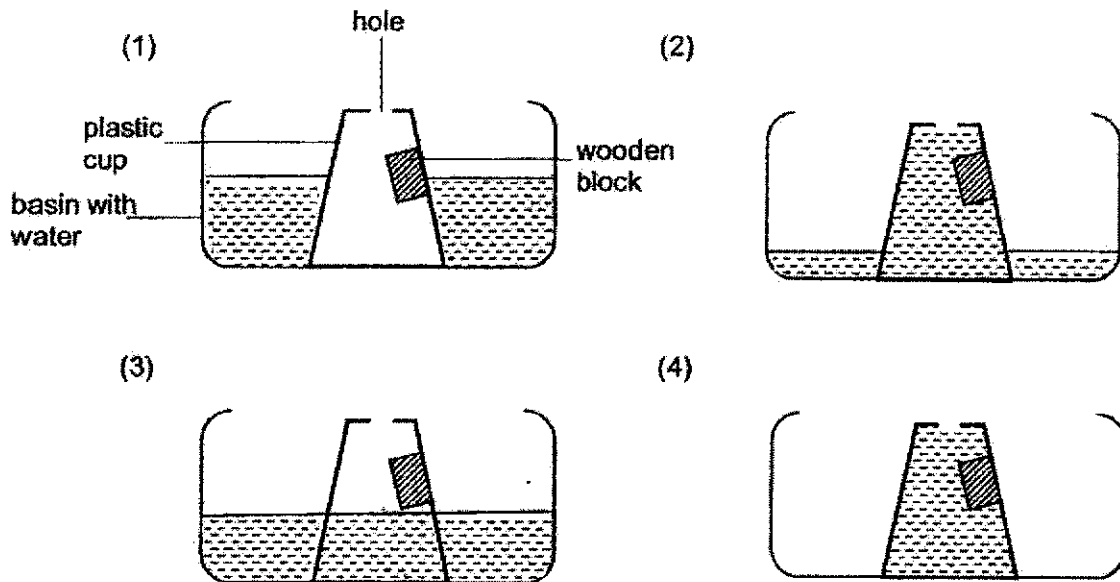

28. The diagram below shows a sealed container with 100 cm^3 of water and 70 cm^3 of air.

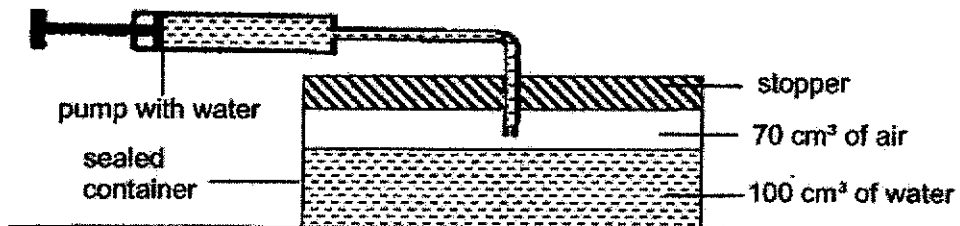

Jolin pumped another 20 cm^3 of water into the sealed container. What change(s) would Jolin observe about the volume of water and air in the sealed container?

	Change in volume of water	Change in volume of air
(1)	increase	remain the same
(2)	increase	decrease
(3)	increase	increase
(4)	remain the same	remain the same

~ END OF BOOKLET A ~



**NANYANG PRIMARY SCHOOL
PRIMARY 4 SCIENCE
MID-YEAR EXAMINATION
2021**

BOOKLET B

Total duration for Booklets A and B: 1 h 45 min

Name: _____ ()

Class: Primary 4 ()

Marks Scored:

Booklet A:		56
Booklet B:		44
Total:		100

Any query on marks awarded should be raised by the next day. We seek your understanding in this matter as any delay in the confirmation of marks will lead to delays in the generation of results.

Parent's signature:

**DO NOT OPEN THIS BOOKLET UNTIL YOU ARE TOLD TO DO SO.
FOLLOW ALL INSTRUCTIONS CAREFULLY.**

Booklet B consists of 15 printed pages including this cover page.

Section B: Open-Ended Questions [44 marks]

Write your answers to Questions 29 to 40 in the spaces provided.

29. Lily wanted to find out if the green bean plants need sunlight to grow.

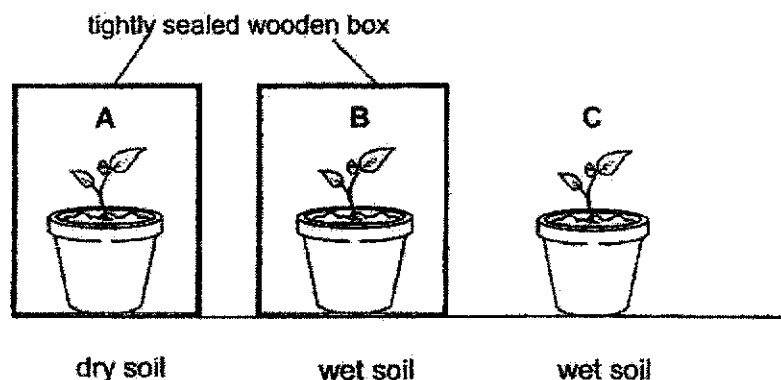

- (a) Which 2 set-ups should she choose in order to have a fair test? [1]

- (b) State the 2 conditions needed for the plants to grow best. [1]

Lily put up another set-up as shown in the diagram below. She placed a pot of plant in a black container with an opening. After one week, she observed that the plant had tilted towards the opening.

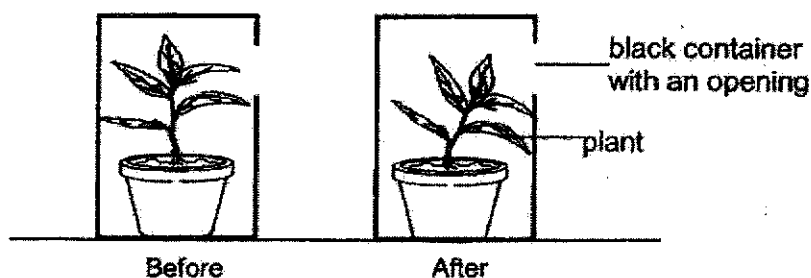

- (c) What characteristic of living things does this show? [1]

- (d) State another characteristic of living things. [1]

30. The diagram below shows four plants, E, F, G and H, present in the pond.

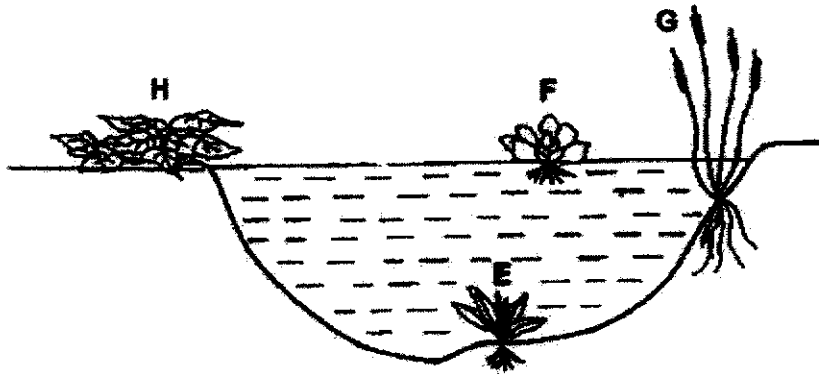

(a) State the suitable headings in the classification table below. [2]

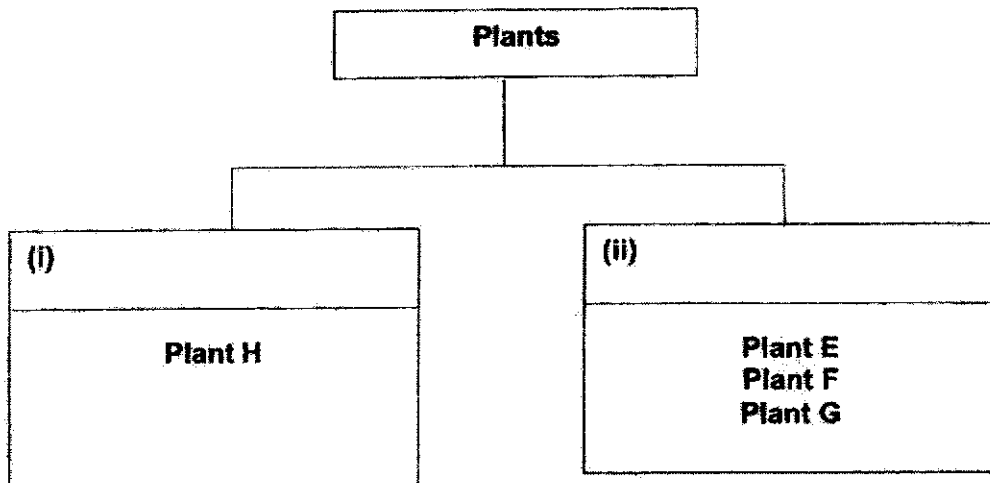

(b) Sam saw that plant H does not have flowers and concluded that it is a non-flowering plant. Explain why Sam's conclusion may be wrong. [1]

31. The table below shows the classification of some animals.

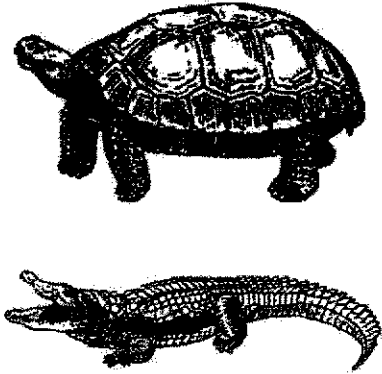
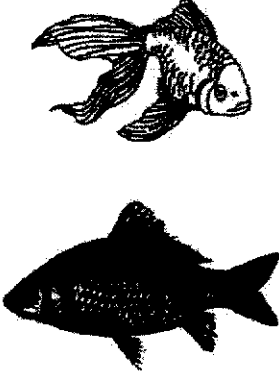
K	L
	

(a) Identify the animal groups shown in the table above. [1]

(i) K: _____

(ii) L: _____

(b) State one similar characteristic between the animals in group K and group L. [1]

(c) State one different characteristic between the animals in group K and group L. [1]

Jane saw an animal and record her observations as shown in the diagram below.

- It has 8 legs.
- It has 2 body parts.



(d) Jane said that it was an insect. Show comparison to explain why she was wrong. [1]

32. The diagram below shows plant X and plant Y. Plant X is growing up a pole.

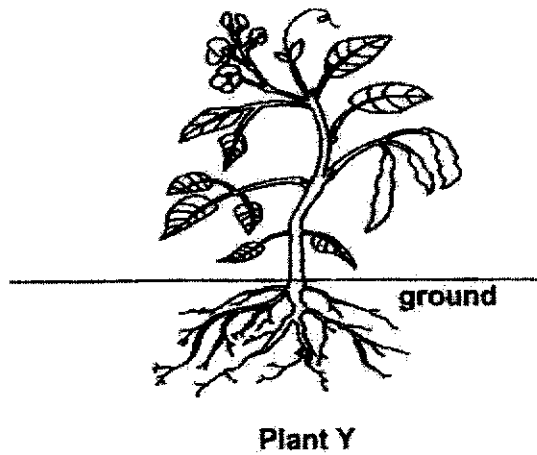
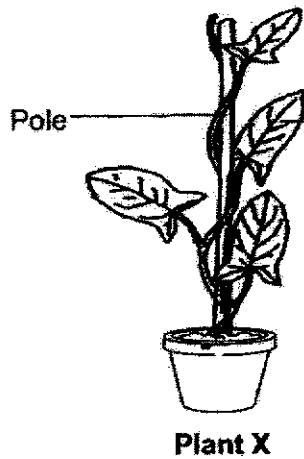

(a) Other than the thickness of the stems, state another difference between the stems of plant X and plant Y. [1]

John removed the pole from plant X. After one week, he observed that the leaves of plant X turned yellow and the plant died.

(b) Explain why plant X died after the pole was removed. [2]

33. The diagram below shows the human digestive system.

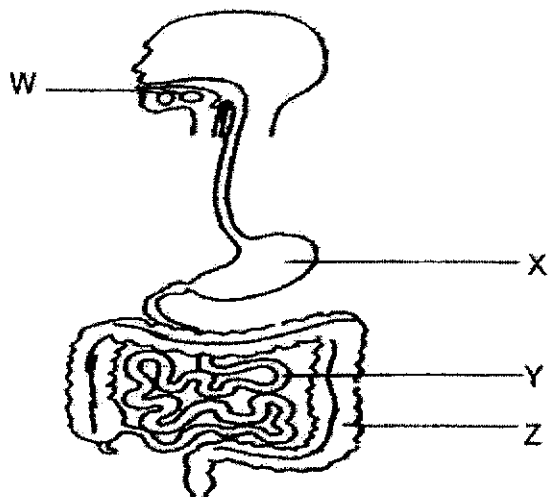

- (a) Which of the above organ(s), W, X, Y or Z, produce(s) digestive juices? [1]

- (b) Identify the human organ system that works closely with the digestive system after digested food is being absorbed in the small intestine. [1]

The diagram below shows some grapes before cut and some cut-up grapes.

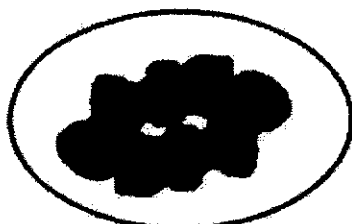

grapes before cut



cut-up grapes

- (c)(i) Which grapes can be digested faster? Circle your answer. [1]

Grapes before cut

Cut-up grapes

- (ii) Explain your answer. [1]

34. Alex made a temporary magnet using the stroke method. He wanted to find out how the number of strokes affects the number of steel pins attracted to it. Using an iron nail and a bar magnet, he carried out the experiment and recorded his results in the table below.

Number of strokes	Number of steel pins attracted
10	2
15	4
20	6
25	?
30	10

- (a) Predict the number of steel pins attracted when he stroked the magnet 25 times. [1]

_____ steel pins

- (b) Based on the results shown, what is the relationship between the number of strokes and the number of steel pins attracted? [1]

Alex's brother placed some objects into a box and filled it with sand. Alex wanted to take some of the objects out from the box.

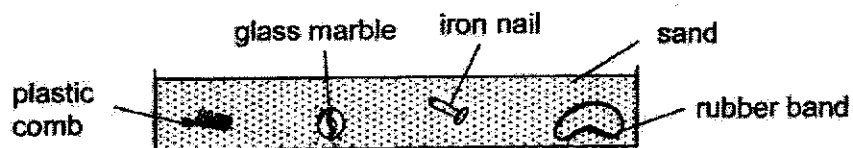

- (c) Which is/are the object(s) that could not be taken out from the box using the bar magnet? [1]

- (d) Give a reason why the objects in (c) could not be taken out from the box using the magnet. [1]

35. In the diagram below, Denzel could see his toy when the lamp in his room was switched on.

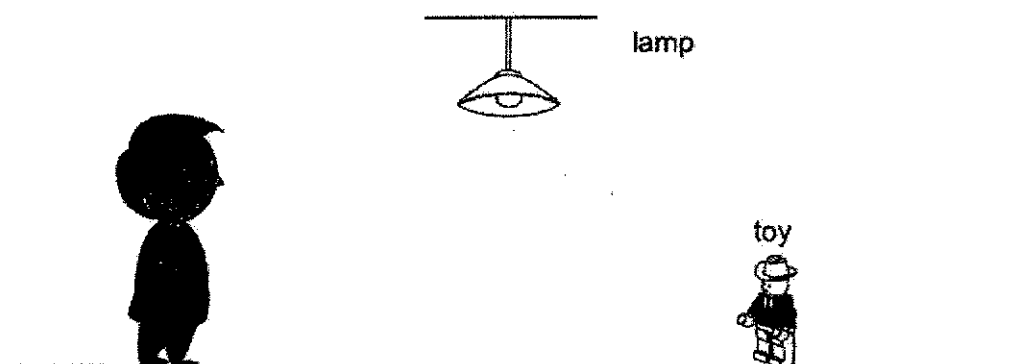

- (a) Explain how Denzel was able to see his toy when the lamp was switched on. [1]

- (b) Put a cross (X) in the diagram above to show the position of the shadow formed by the toy. [1]

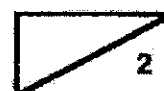

36. Gerald wanted to observe the shadows formed by object T. Object T does not allow light to pass through. Object T was placed in two different positions in front of two identical torches as shown below.

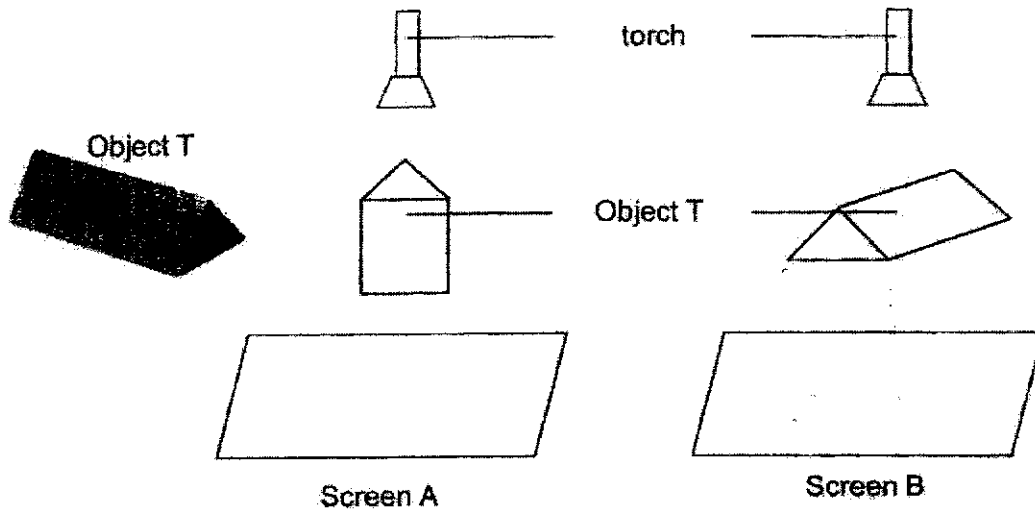

(a) In the boxes below, draw the shadows that were formed on screen A and screen B. [2]

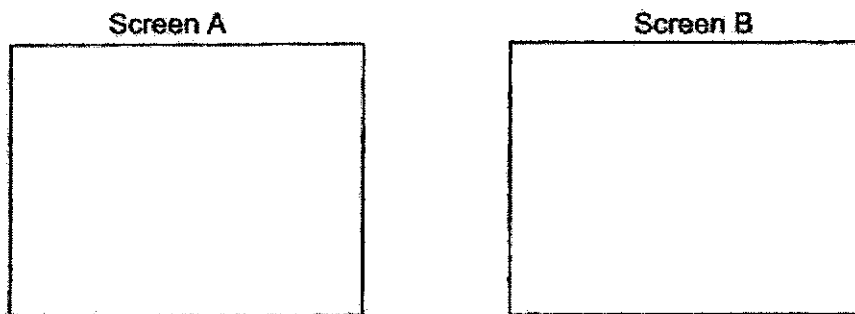

(b) Explain how shadows are formed. [1]

37. Berlin, Evan and Sean carried out an experiment as shown below to investigate the amount of light that passed through 3 different materials, W, X and Y.

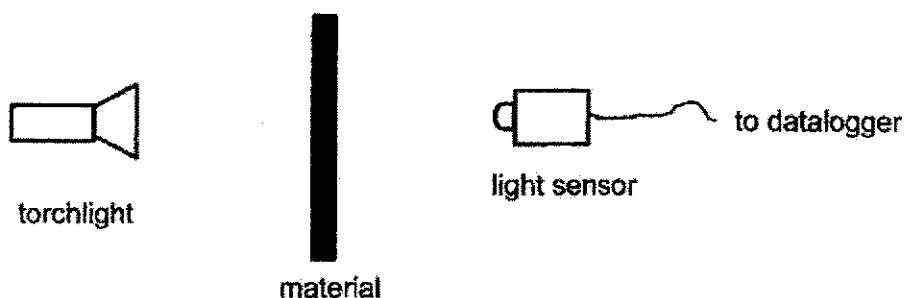

- (a) In the table below, put a tick (✓) next to the variable(s) that must be kept the same so that the experiment will be a fair test. [1]

i)	brightness of the torch	
ii)	thickness of each material	
iii)	material used for the experiment	
iv)	distance between material and light source	
v)	distance between material and light sensor	

The different amount of light passing through materials W, X and Y were shown in the graph below.

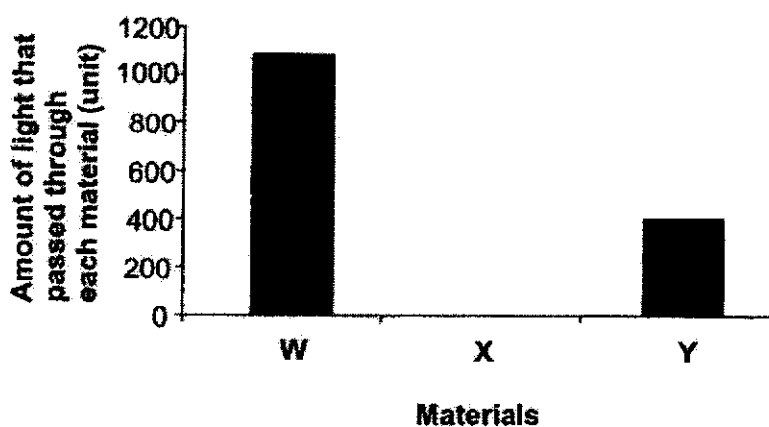

(Continue from Question 37)

Berlin and Sean visited a display in a dark room in the museum. Each of them stood in front of a display case made of a different material on each side.

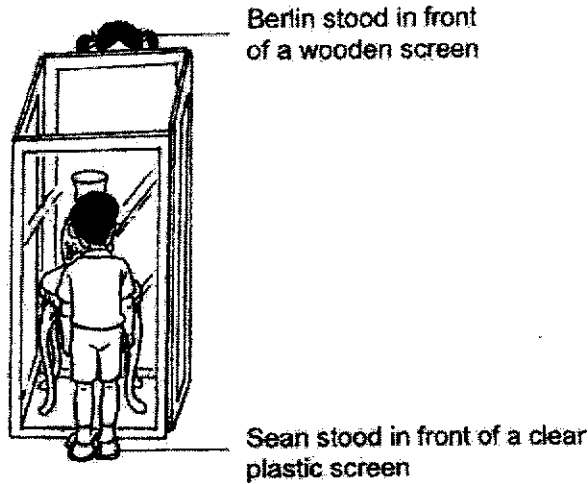

(b) Based on the results shown in the graph above, which material, W, X or Y, would most likely represent the different screen in front of each child? [1]

Berlin : Material _____

Sean : Material _____

(c) Why must the experiment be conducted in a dark room? [1]

(d) Which material is the most suitable to make a bathroom door? Explain your answer. [2]



38. Alan placed three objects, A, B and C, on a balance to compare their masses as shown in the diagram below.

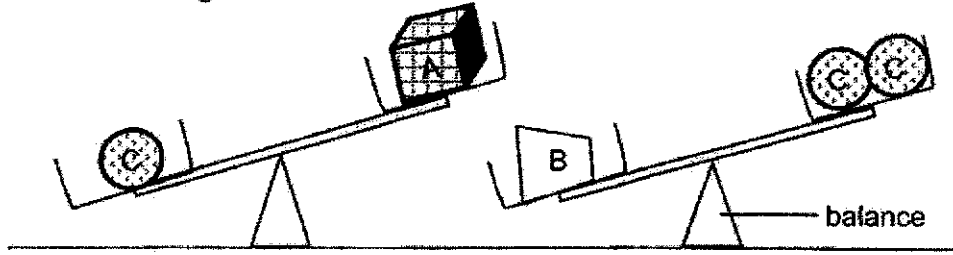

(a) Arrange the objects, A, B and C, according to their masses in the spaces below. [1]

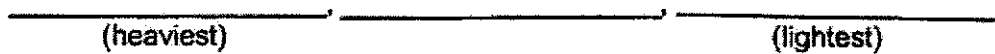

Alan had 3 identical containers with the same amount of water in it. He placed objects A, B and C separately into each container as shown below. He then recorded the water level marking on the containers.

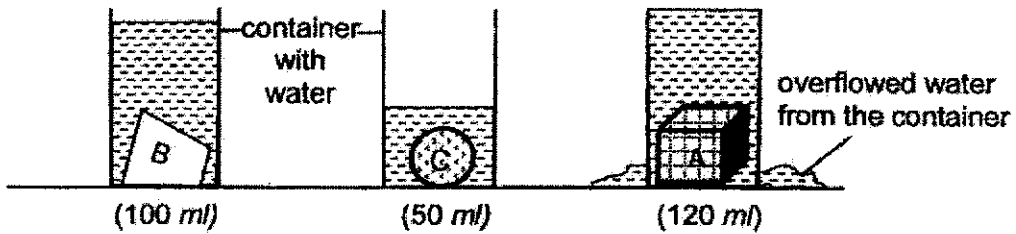

(b) Based on Alan's observation, what could he conclude about the volume of objects, A, B and C? [1]

(c) Alan conducted another experiment by changing the shape of object C to be the same shape as object B. He placed it back into the identical container with the same amount of water. In Diagram 2 below, draw the water level in the container. [1]

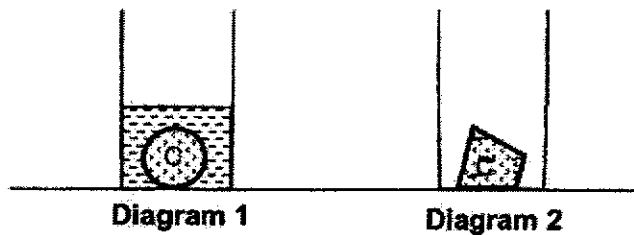

39. Ashley attached an inflated balloon onto an empty plastic bottle as shown in the diagram below. She observed that the air in the balloon did not empty into the bottle.

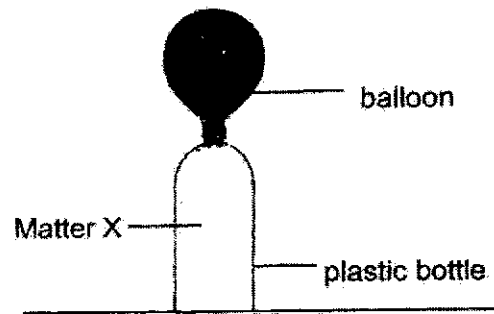

- (a) Identify the state of matter X that was present in the bottle. [1]

- (b) State what Ashley could do to release the air into the bottle without making any change to the balloon. [1]

Ashley then placed a smaller balloon into a big inflated balloon as shown in the diagram below.

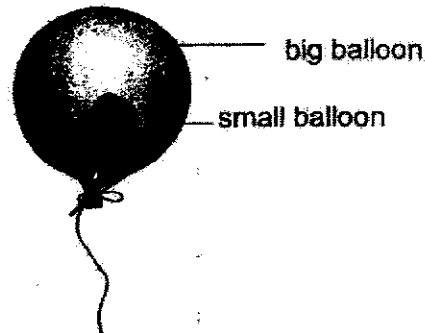

- (c) Explain why she was able to inflate the smaller balloon when she pumped air into it. [2]

40. Ahmad filled a syringe with 40 cm^3 of sand and 60 cm^3 of air and placed a stopper at the mouth of the syringe as shown in the diagram below.

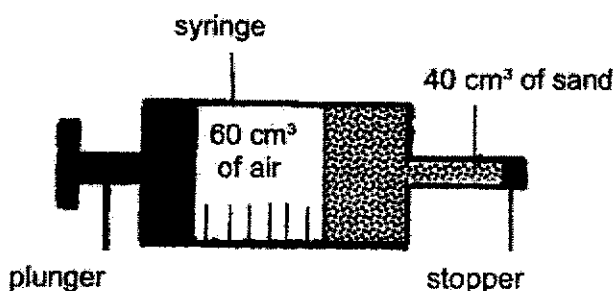

Ahmad pushed the plunger towards the stopper 3 times until he cannot push the plunger anymore. He measured the volume of air in the syringe after each push as shown in the table below.

Number of push	Volume of air in the syringe (cm^3)
0	60
1	45
2	35
3	25

- (a)(i) State the volume of sand in the syringe after the first push of the plunger. [1]

_____ cm^3

- (ii) Using the property of matter, explain your answer in (a)(i). [1]

(Turn over to next page)

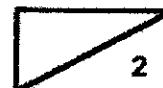

(Continue from Question 40)

Ahmad set up another experiment with two identical containers, X and Y. He fitted each container with a glass tube and a funnel as shown in the diagram below.

In container Y, a stopper was attached to the glass tube. He then filled both containers with the same volume of water through the funnels.

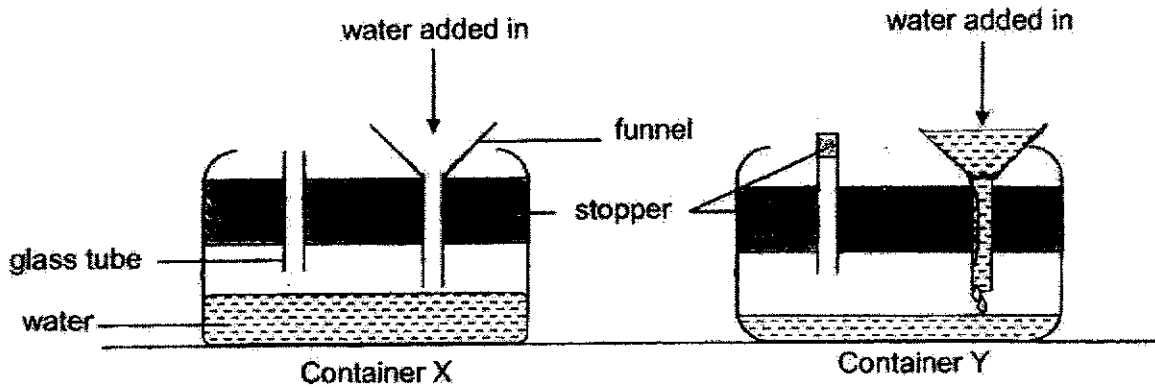

- (b) He noticed that the water in container Y flowed in very slowly but the water in container X flowed in faster. Explain why. [2]



- (c) What should he do to the funnel in container Y to allow the water to flow in faster? [1]

~ END OF BOOKLET B ~

SCHOOL : NAN YANG PRIMARY SCHOOL
LEVEL : PRIMARY 4
SUBJECT : SCIENCE
TERM : SA 1

Q1	Q2	Q3	Q4	Q5	Q6	Q7	Q8	Q9	Q10
3	4	1	2	1	2	4	3	3	3
Q11	Q12	Q13	Q14	Q15	Q16	Q17	Q18	Q19	Q20
3	3	3	4	2	2	2	2	4	3
Q21	Q22	Q23	Q24	Q25	Q26	Q27	Q28		
4	3	3	2	1	2	3	2		

29	<ul style="list-style-type: none"> a) B and C b) The plant has air, water, and sunlight to make food. c) Living things respond to changes (in the surroundings). d) Living things reproduce. <p>*other characteristics of living things</p>
30	<ul style="list-style-type: none"> a) i) Land plants ii) Water plants b) it is not the right time/condition for Plant H to bear flowers.
31	<ul style="list-style-type: none"> a) i) Reptile ii) Fish b) both have scales/lay eggs c) Animal in K have legs to move around while animals in L have fins to move around. d) Insects have 6 legs/3 body parts while the animal has 8 legs/2 body parts
32	<ul style="list-style-type: none"> a) Plant X has a weak stem while plant Y has a strong stem. b) Plant X does not have a support to reach out for enough light. It was not able to make food to grow well.
33	<ul style="list-style-type: none"> a) W, X and Y b) Circulatory system c) i) Cut-up grapes (Cross or circle) d) ii) The smaller pieces of grapes will (allow digestion to take place faster).
34	<ul style="list-style-type: none"> a) 7, 8 or 9 b) When the number of strokes increases, the number of pins attached increase c) Glass marble, rubber band and plastic comb
35	<ul style="list-style-type: none"> a) The toy reflects light from the lamp into Denzel's eyes.

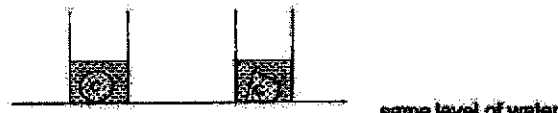
																	
36	<p>b)</p> <p>Screen A Screen B</p>  <p>a) b) Shadows are formed when light is partially y or fully blocked by an object</p>																
37A	a)	<table border="1"> <tbody> <tr> <td>i)</td> <td>Brightness of the torch</td> <td>✓</td> </tr> <tr> <td>ii)</td> <td>Thickness of each material</td> <td>✓</td> </tr> <tr> <td>iii)</td> <td>Material use for the experiment</td> <td></td> </tr> <tr> <td>iv)</td> <td>Distance between material and light source</td> <td>✓</td> </tr> <tr> <td>v)</td> <td>Distance between material and light sensor</td> <td>✓</td> </tr> </tbody> </table>	i)	Brightness of the torch	✓	ii)	Thickness of each material	✓	iii)	Material use for the experiment		iv)	Distance between material and light source	✓	v)	Distance between material and light sensor	✓
i)	Brightness of the torch	✓															
ii)	Thickness of each material	✓															
iii)	Material use for the experiment																
iv)	Distance between material and light source	✓															
v)	Distance between material and light sensor	✓															
37B	<p>Berlin: Material X</p> <p>Sean: Material W</p>																
37C	<p>To be able to detect the light from the light source no other light sources will affect the experiment.</p>																
37D	<p>Material X. Material X does not allow any light to pass through it so that nobody can see the user in the bathroom</p>																
38	<p>a) <u> </u> B, <u> </u> C, <u> </u> A <u> </u> (heaviest) (Lightest)</p> <p>b) A has the greatest volume as compared to B and C.</p>																
	 <p>c)</p>																
39	<p>a) Gaseous state/Gas</p> <p>b) Poke a hole on the bottle</p> <p>c) The air in the big balloon became compressed to allow air to enter the smaller balloon.</p>																
40	<p>i) 40cm³</p> <p>ii) Sand is a solid, it has a definite volume and cannot be compressed.</p> <p>b) Air in container X escaped through the glass tube so the water could flow into the funnel faster. Air in container Y could not scape but was compressed, therefore the water flowed into the funnel slowly.</p> <p>c) Tilt the funnel.</p>																