



MARIS STELLA HIGH SCHOOL (PRIMARY)

SEMESTRAL ASSESSMENT 1

SCIENCE

13 MAY 2015

BOOKLET A

NAME: _____

CLASS: Primary 4 ()

30 questions

60 marks

Total Time for Booklets A & B: 1 h 30 min

DO NOT OPEN THIS BOOKLET UNTIL YOU ARE TOLD TO DO SO.

FOLLOW ALL INSTRUCTIONS CAREFULLY.

For each question from 1 to 30, four options are given. One of them is the correct answer. Make your choice (1, 2, 3 or 4). Shade the correct oval (1, 2, 3 or 4) on the Optical Answer Sheet (OAS). (30 x 2 marks)

1 Study the life cycle of a butterfly below.

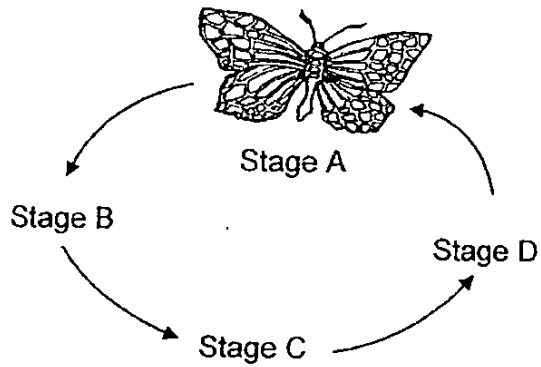

At which stage does moulting of the butterfly take place?

- (1) A
- (2) B
- (3) C
- (4) D

2 Sophie dropped a bar magnet and it broke into two pieces.

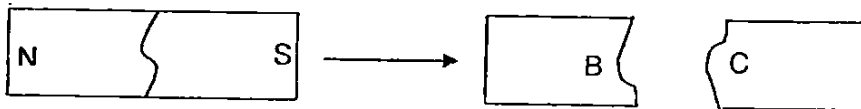

What are the poles of parts B and C on the two pieces of broken magnet?

	B	C
(1)	North	South
(2)	South	North
(3)	South	South
(4)	North	North

- 3 Justin observed that the hermit crab pulled its head into the shell when he touched it.

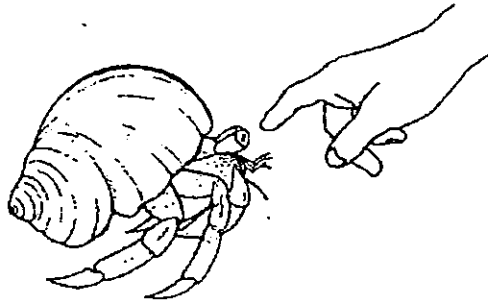

What could Justin learn about living things from his observation?

- (1) A living thing can grow.
 - (2) A living thing can reproduce.
 - (3) A living thing needs air, food and water.
 - (4) A living thing responds to changes around it.
- 4 Kayden caught a frog from his school field and put it in a container as shown below. The frog died after some time.

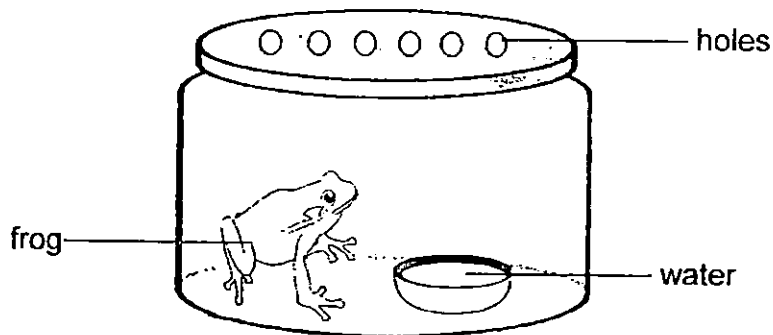

What could Kayden have done to prevent the frog from dying?

- (1) Use a bigger container
- (2) Put some food in the container
- (3) Remove the water in the container
- (4) Cover up the holes on the container

5 Study the flow chart below.

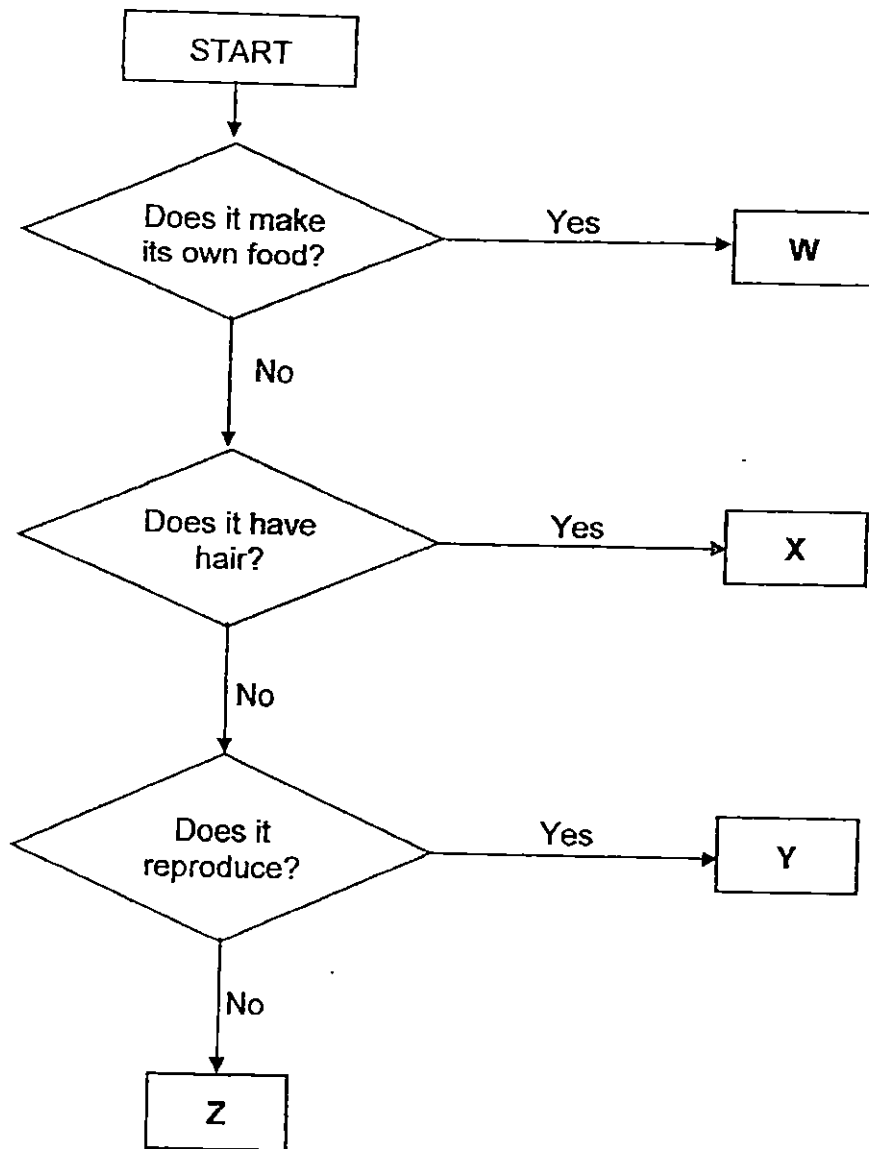

Based on the flow chart, which of the following are correct?

- A X is a mammal.
- B W is a type of plant.
- C Z is a non-living thing.
- D Y could be a type of fungi.

- (1) A and B only
- (2) B and C only
- (3) A, B and D only
- (4) A, B, C and D

- b Study the plant below.

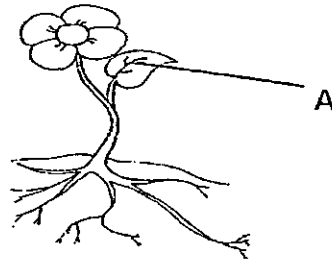

What is the function of A?

- (1) To protect the seed
- (2) To keep the plant upright
- (3) To make food for the plant
- (4) To take in water for the plant

- 7 The diagram below shows 3 different containers each filled with 500 ml of water.

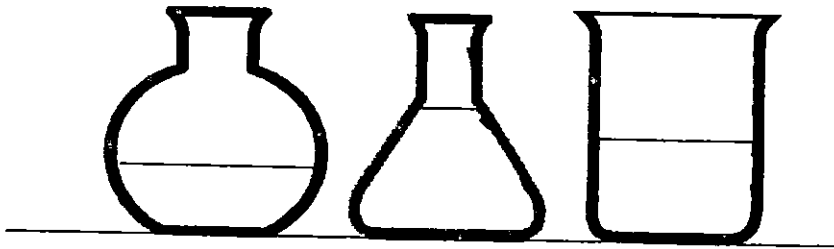

Based on the observation of water in each container, we can conclude that water

_____.

- (1) can be compressed
- (2) has no definite mass
- (3) has no definite volume
- (4) has no definite shape

8 Study the diagram below.

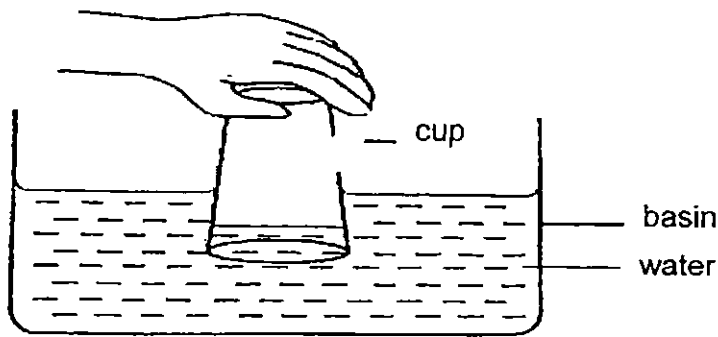

The water level is lower in the cup than in the basin because ___

- (1) air cannot be compressed
- (2) air in the cup takes up space
- (3) water does not have a definite shape
- (4) water does not have a definite volume

9 The graph below shows the growth of a green bean plant over 8 days.

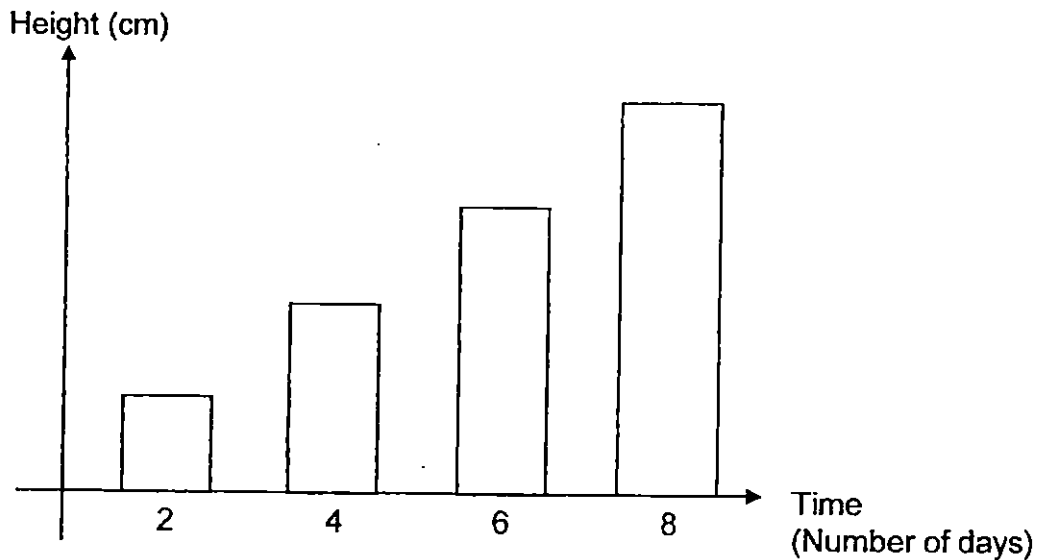

What can you conclude about the green bean plant from the graph above?

- (1) The plant has reproduced.
- (2) The plant has grown taller.
- (3) The plant needs water to grow.
- (4) The plant has stopped growing after Day 6.

10 Study the classification chart below.

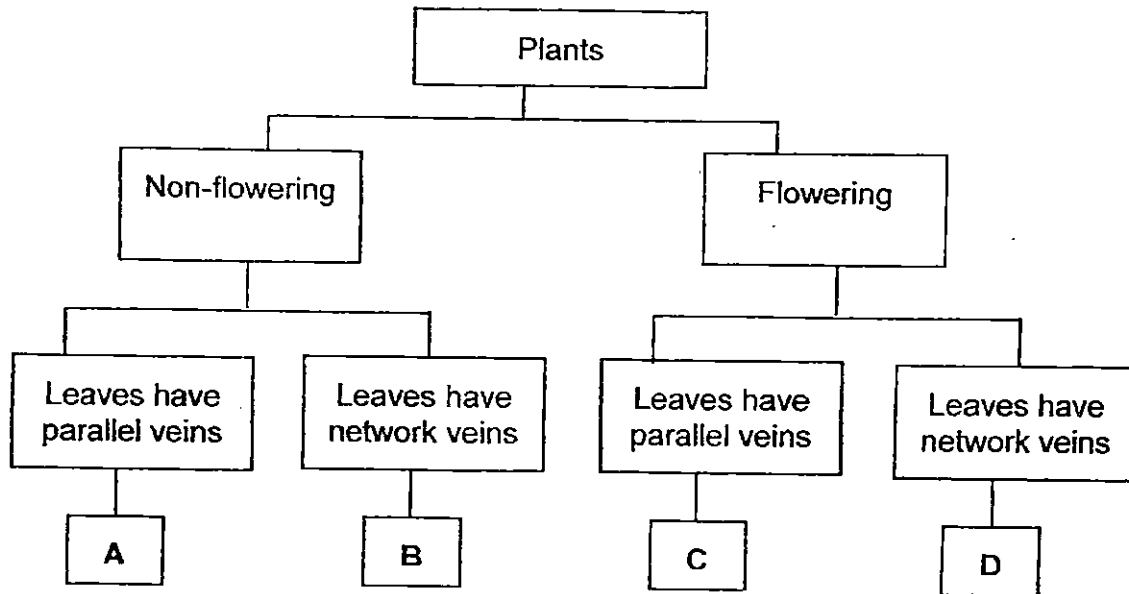

The table below shows the characteristics of Plant E.

Characteristics	Plant E
Produce flowers	Yes
Has parallel veins on leaves	No

In which box, should Plant E be placed in?

- (1) A
- (2) B
- (3) C
- (4) D

- 11 Different human systems is made up of different body parts.
Which body part has been matched **incorrectly** to the human system?

	Human system	Body part
(1)	Muscular	Muscles
(2)	Skeletal	Bones
(3)	Respiratory	Nose
(4)	Circulatory	blood vessels

- 12 Study the four different arrangements of the magnets.

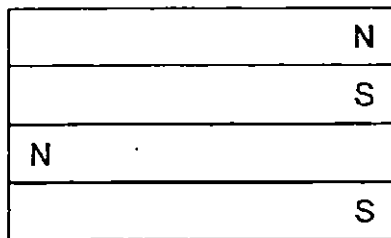

Set up A

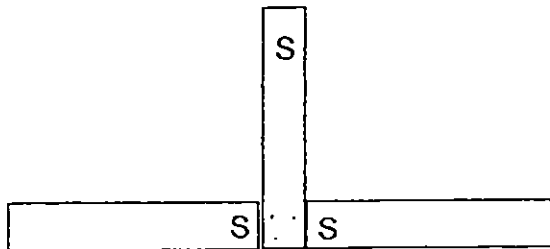

Set up B

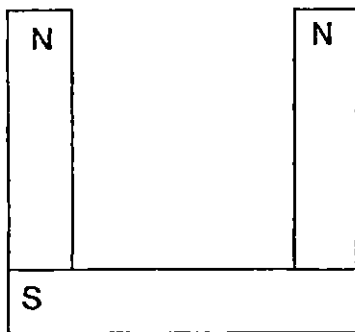

Set up C

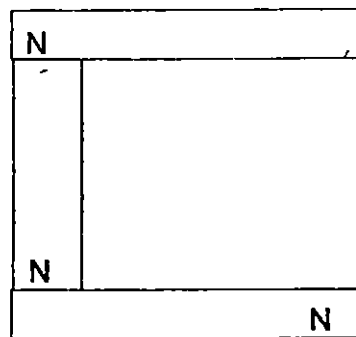

Set up D

Which two of the set ups are possible?

- (1) Set up A and Set up B
- (2) Set up A and Set up C
- (3) Set up B and Set up D
- (4) Set up C and Set up D

- 13 Ali wanted to pour out liquid paint from two identical tin, A and B. He punched one hole through tin A and two holes through tin B as shown in the diagram below.

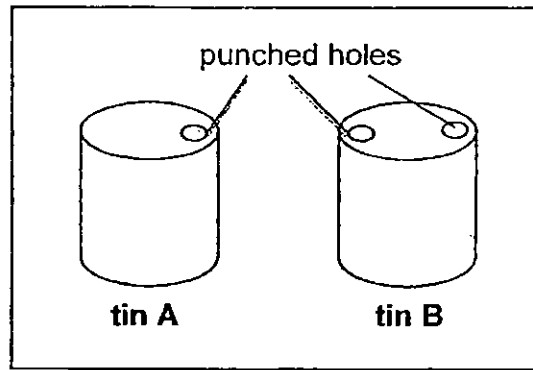

She then tilted both tins at the same angle to pour out the liquid paint as shown below.

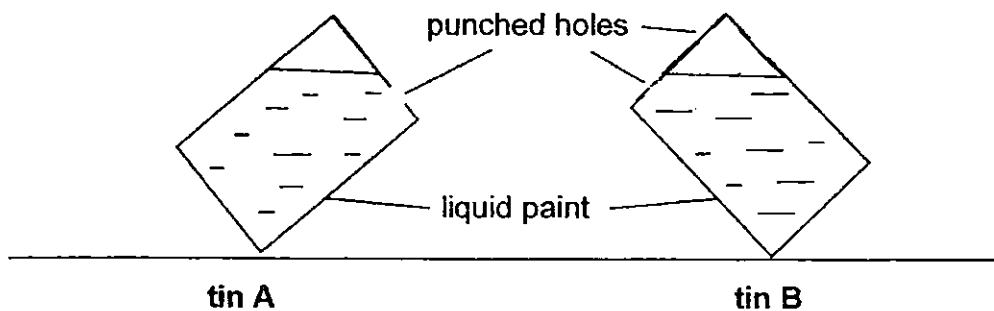

Based on the observation above, which of the following would most likely happen?

- (1) Only liquid paint from tin A would flow out.
- (2) No liquid paint would flow out from both tins A and B.
- (3) Liquid paint from tin A would flow out as quickly as liquid paint from tin B.
- (4) Liquid paint from tin B would flow out more quickly than liquid paint from tin A.

- 14 A number of items and the materials they are made of are listed below.
Which of the following items is **incorrectly** matched to the materials it is made of?

	Item	Material item is made of
(1)	Football t-shirt	Fabric
(2)	Magnifying lens	Glass
(3)	Electrical wires	Metal
(4)	Ceiling fan	Plasticine

- 15 Which of the following are the properties of part A of the balloon?

- A Stiff,
- B Light
- C Flexible

- (1) A and B only
- (2) A and C only
- (3) B and C only
- (4) A, B and C

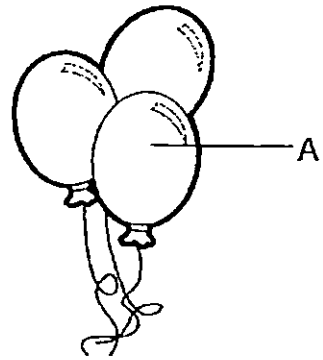

- 16 Adam wants to find out if the numbers of batteries will affect the number of paper clips an electromagnet can attract.

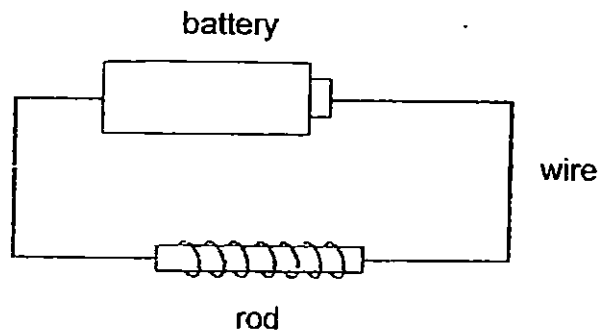

What is one important variable that must be kept constant in order to ensure a fair test?

- (1) Number of batteries
- (2) Shape of the paper clips
- (3) Material of the paper clips
- (4) Number of paper clips attracted

- 17 Sharon wanted to test the magnetic strength of four different horseshoe magnets. W, X, Y and Z. She measured the furthest distance a safety pin could be attracted from magnet W. She repeated the step with magnets X, Y and Z using the same safety pin.

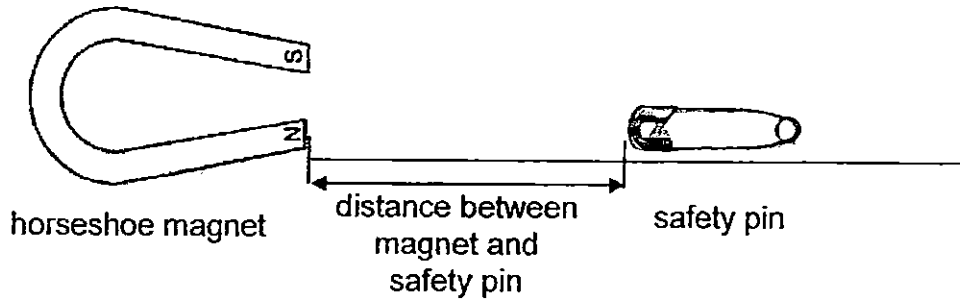

Magnet	Distance between magnet and safety pin (cm)
W	3
X	2
Y	1
Z	5

Which magnet has the strongest magnetic strength?

- (1) W
- (2) X
- (3) Y
- (4) Z

- 18 The diagram below shows a part of our body.



This part needs _____ to pick up a can.

- (1) a heart
- (2) lungs
- (3) muscles
- (4) a large intestine

- 19 Alan hung a magnet between two objects X and Y. He made the observation as shown below.

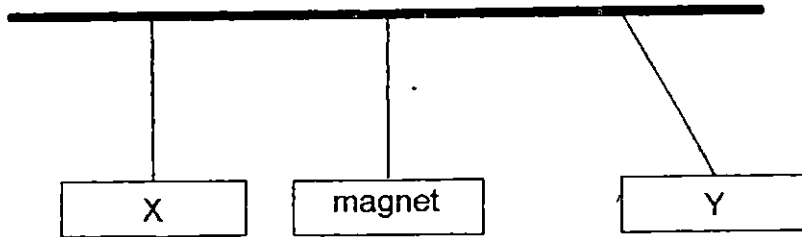

What can he conclude about objects X and Y?

	X	Y
(1)	It is a magnet.	It is made of non-magnetic material.
(2)	It is made of magnetic material.	It is made of magnetic material.
(3)	It is made of magnetic material.	It is a magnet
(4)	It is made of non-magnetic material.	It is a magnet.

- 20 Matthew made a list of the magnetic objects that he knew.

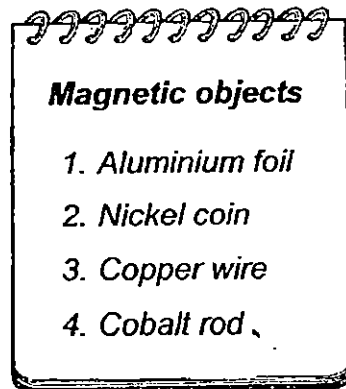

However, not all the objects are magnetic.
Which of the following objects are non-magnetic?

- (1) Cobalt rod and nickel coin
- (2) Copper wire and nickel coin
- (3) Aluminium foil and cobalt rod
- (4) Aluminium foil and copper wire

- 21 Jonathan tied a bar magnet to a piece of styrofoam. He then placed it in a basin of water and spun the bar magnet. He recorded the position of the magnet when it came to rest. He repeated the action and realized that the bar magnet always came to rest in the same position.

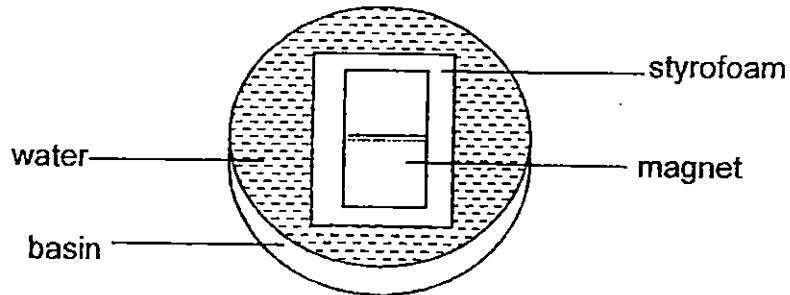

Which of the following shows the position of the bar magnet when it comes to a rest?

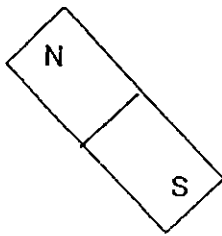

(1)



(2)

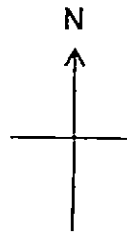

(3)



(4)

- 22 Which one of the following items does not have a magnet in them?

- (1) Compass
- (2) Metal tray
- (3) Credit card
- (4) Refrigerator

- 23 A clown fills two balloons with air. He then twists and squeezes them together so that they are shaped like an animal as shown below.

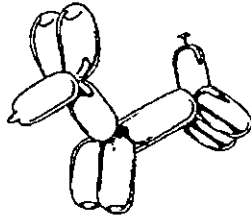

What property of air allowed the clown to change the shape of the balloon?

- (1) Air has mass.
 - (2) Air is a matter.
 - (3) Air can be compressed.
 - (4) Air do not occupy space.
- 24 The flow chart below shows the properties of 3 matters A, B and C.

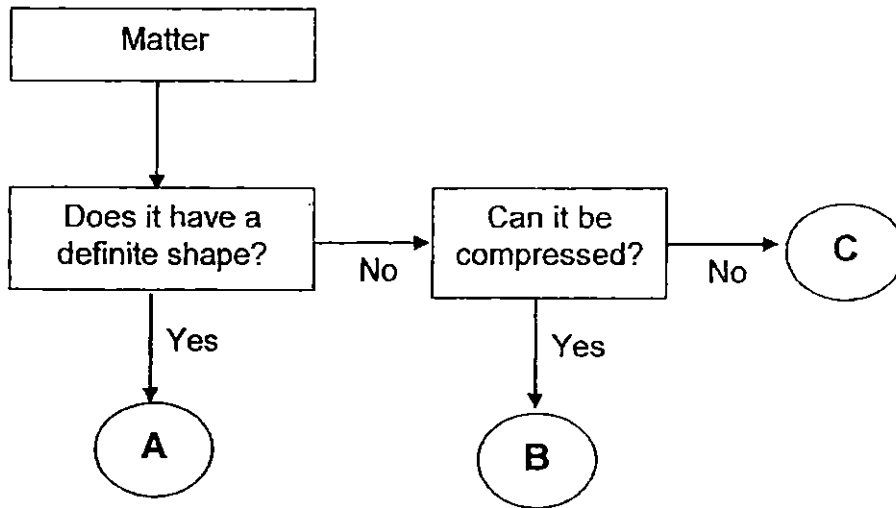

Which of the following represents A, B and C correctly?

	A	B	C
(1)	gas	solid	liquid
(2)	liquid	gas	solid
(3)	solid	gas	liquid
(4)	solid	liquid	gas

25 Study the concept map below.

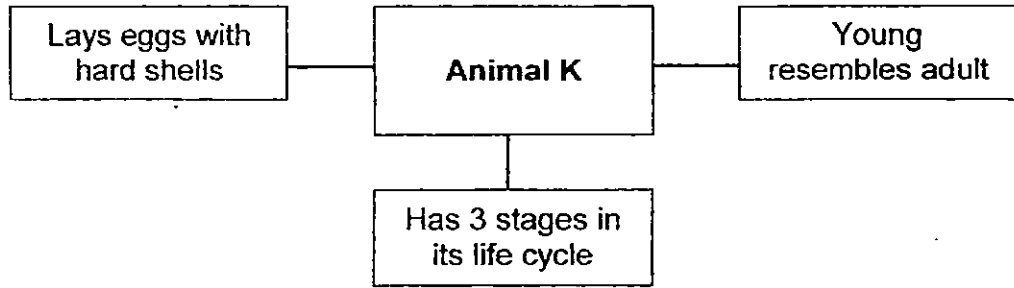

What can Animal K be?

- (1) Frog
- (2) Bird
- (3) Horse
- (4) Butterfly

26 The diagram below shows a glass of water and a glass of ice that has just been taken out of a freezer.

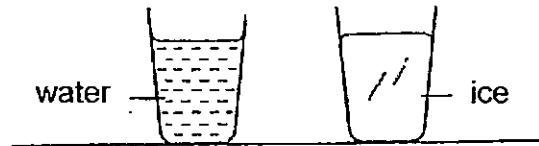

Which two cups, A, B, C or D, below correctly show what is observed when both glasses above are tilted?

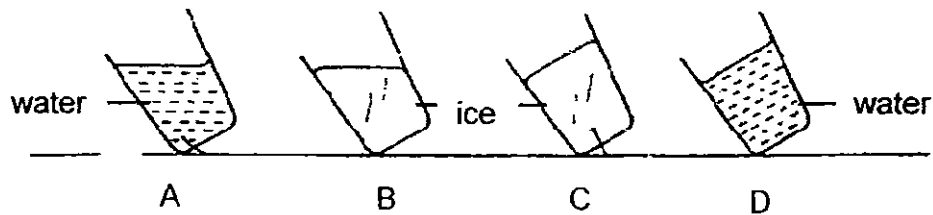

- (1) A and B
- (2) A and C
- (3) B and D
- (4) C and D

- 27 The diagrams below show the two syringes, A and B, at the start of the experiment, before the plungers are pushed in.

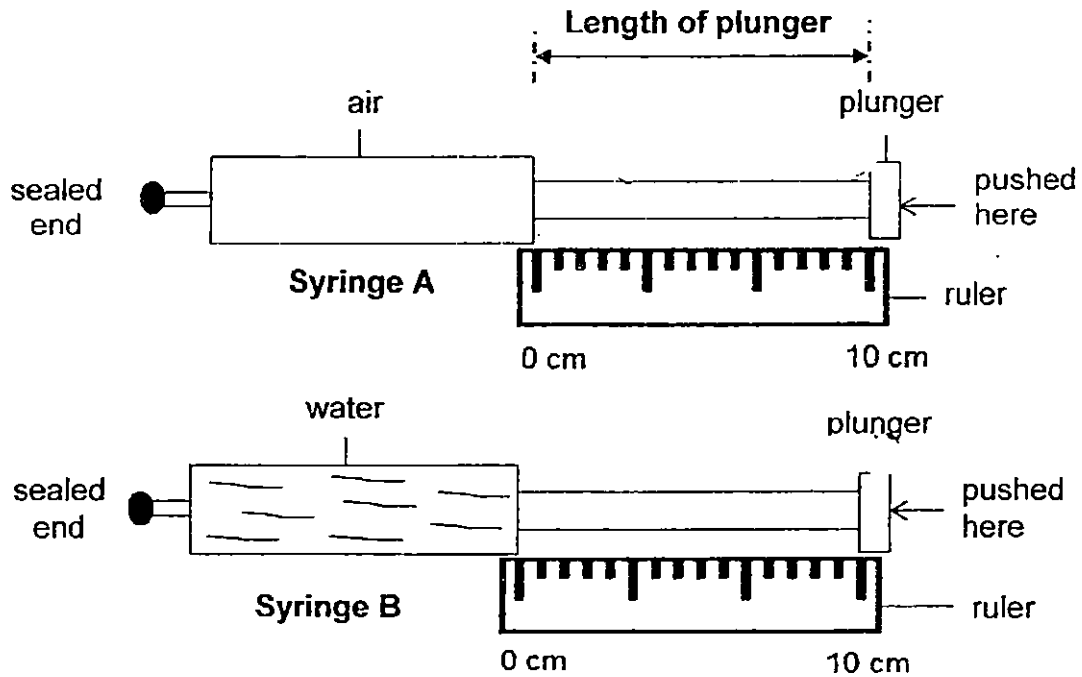

The plunger of each syringe was then pushed in as hard as possible. The length of the plunger was measured.

Which one of the following shows the correct length of the plunger after they were pushed?

Length of plunger (cm)		
	Syringe A	Syringe B
(1)	5	10
(2)	0	10
(3)	8	10
(4)	10	0

- 28 Jane added starch balls to a cup of bubble tea and realised that the water level in the cup increased.

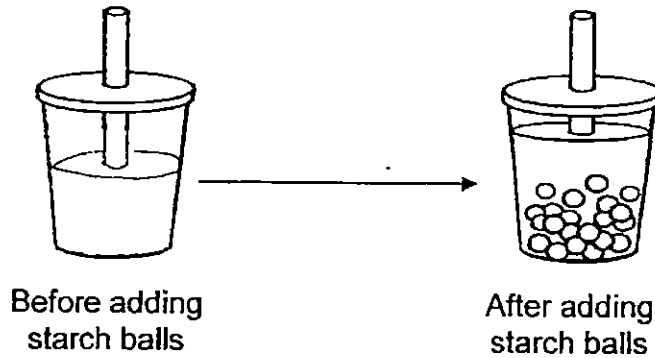

Based on her observation, what can Jane conclude about the starch balls?

- A They occupy space.
 - B They do not have mass.
 - C They have a definite shape.
 - D They cannot be compressed.
- (1) A only
- (2) A and C only
- (3) B and D only
- (4) B, C and D only
- 29 Kai Yang made the two solid objects, Y and Z, below using the same amount of clay.

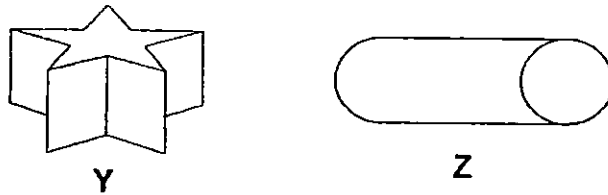

Which of the following statements correctly describe the objects?

- A Both have different weight.
 - B Both have the same amount of matter.
 - C Both do not occupy the same amount of space.
- (1) C only
- (2) A and B only
- (3) B and C only
- (4) A, B and C only

30 The diagrams below show different ways of stroking an iron nail to magnetise it.

Which of the following shows the correct way of magnetising the iron nail?

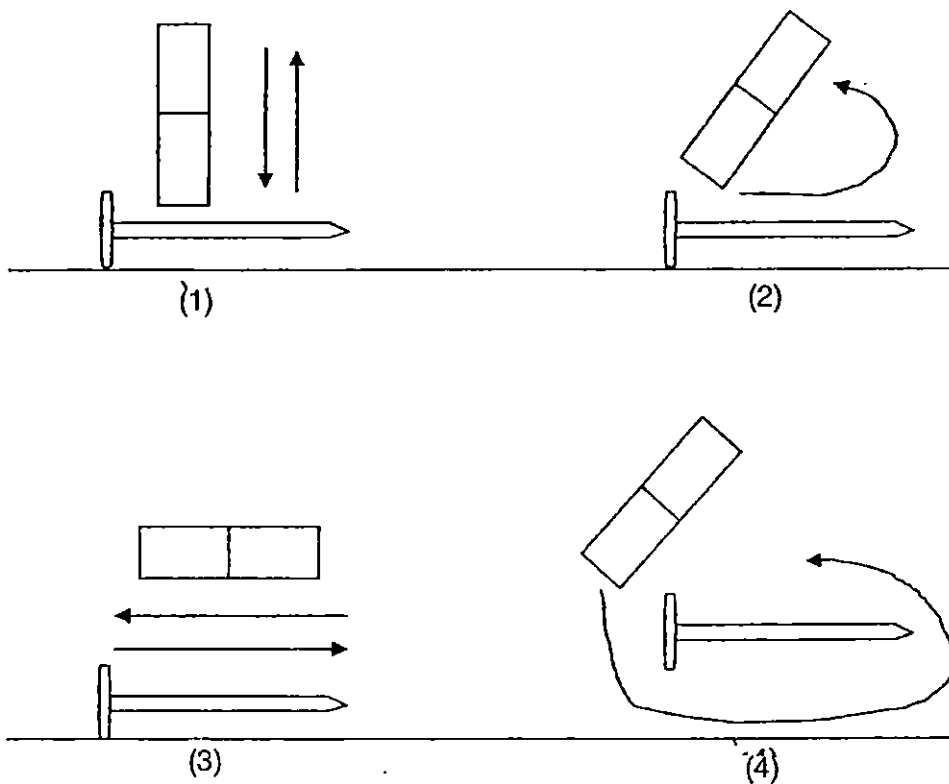

of Booklet A



MARIS STELLA HIGH SCHOOL (PRIMARY)

SEMESTRAL ASSESSMENT 1

SCIENCE

13 MAY 2015

BOOKLET B

NAME: _____

CLASS: Primary 4 ()

14 questions

40 marks

Total Time for Booklets A & B: 1 h 30 min

DO NOT OPEN THIS BOOKLET UNTIL YOU ARE TOLD TO DO SO.
FOLLOW ALL INSTRUCTIONS CAREFULLY.

BOOKLET A: _____ / 60

BOOKLET B: _____ / 40

TOTAL: _____ / 100

PARENT'S SIGNATURE: _____

31 Compare the two animals, A and B, shown below.

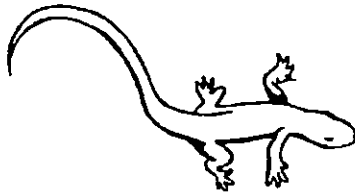

Animal A

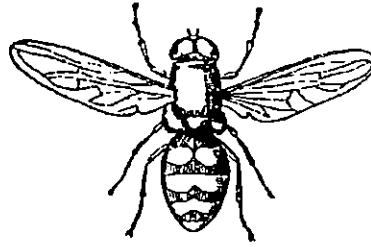

Animal B

(a) State two differences between Animal A and Animal B. [2]

(i) _____

(ii) _____

(b) Which animal group does Animal B belong to? [1]

(c) Give a reason for your answer in (b). [1]

	4
--	---

- 32 Eight animals were classified according to their method of reproduction as shown below.

Group X	Group Y
Dog Rabbit Hamster Monkey	Snake Goldfish Cockroach House lizard

- (a) Give a suitable heading for X and Y. [1]

X: _____

Y: _____

- (b) In which group (X or Y) should a penguin be classified? [1]

33 Study the flow chart below.

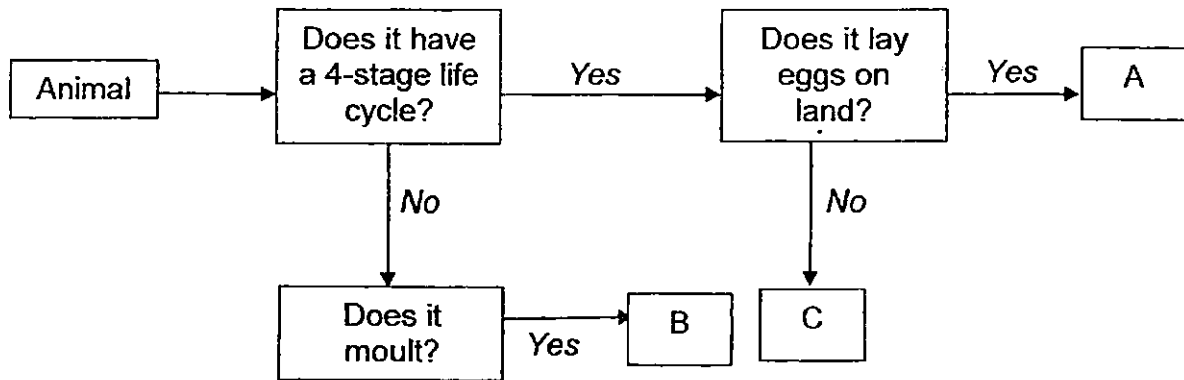

(a) Based on the flow chart, describe animal A. [2]

(b) Give one example of animal B. [1]

Animal B: _____

(c) Draw the life cycle of animal C. [1]

- 34 John put three green beans into each beaker and placed both beakers near the window in the classroom.

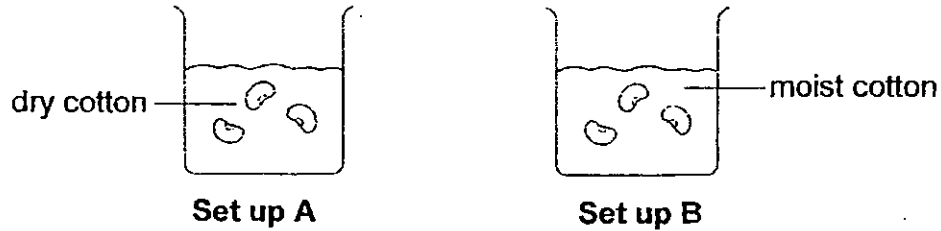

(a) In which set up (A or B) will the seed germinate? _____ [1]

(b) Give a reason for your answer in (a). [1]

(c) Which part of the seed provides food for the germinating seed? [1]

(d) Which part of the plant will grow out from the seed first during germination? [1]

35 The boxes below show the different organs in the digestive system.

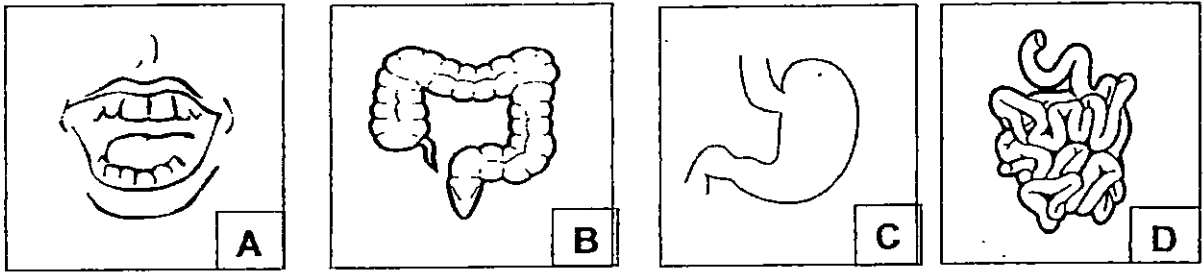

(a) Write letters (B, C and D) in the boxes provided to show the correct movement of food as it moves through the digestive system. [1]

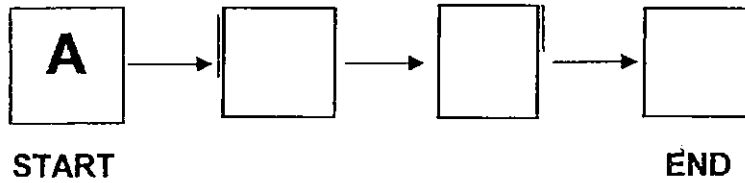

(b) Match the organs (A, B, C and D) to the functions listed in the table below. Write the letters (A, B, C or D) in the table below. [2]

	Function	Organ
(i)	Most of the digestion takes place here.	
(ii)	Excess water and mineral salts are absorbed from the undigested food.	
(iii)	Digestion is completed here.	
(iv)	Food is broken down into smaller pieces.	

- 36 Oliver dropped the magnet from a height of 1 metre and records the number of paper clips the magnet attracted after it was dropped. He repeated the experiments by dropping the magnets for different number of times.

Number of times the magnet is dropped	Number of paper clips attracted
0	15
1	14
2	12
3	10
4	9
5	7

- (a) State the following variables: [2]

(i) Manipulated variable: _____

(ii) Responding variable: _____

- (b) What is the aim of Oliver's experiment? [1]

- (c) State an important variable that Oliver needs to keep the same for a fair test. [1]



- 37 Jacob hung four different materials, P, Q, R and S of the same size and shape on a string and put part of the materials into a tray of coloured water. All materials are placed at the same distance away from the coloured water as shown in the diagram below.

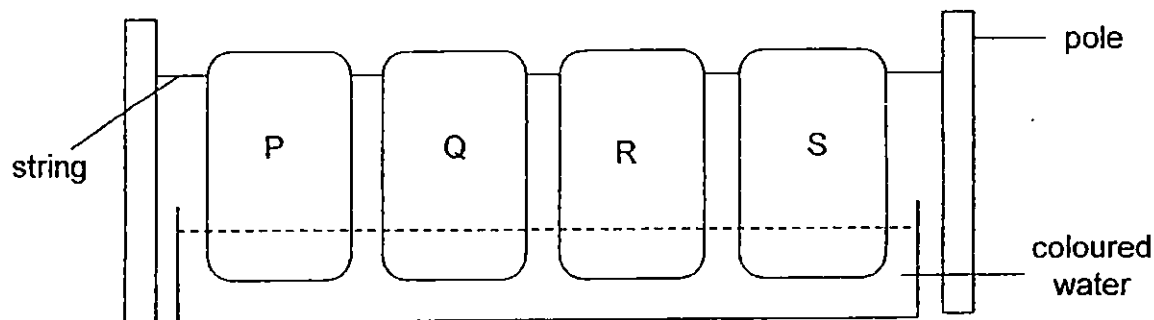

He noticed that the coloured water move up the materials. After 3 minutes, he measured the height in which the water rose to on the hand towel. The results are recorded in the table below.

Material	Height where the water rose to (cm)
P	2
Q	8
R	14
S	5

- (a) Which material (P, Q, R, S) should Jacob choose to make a hand towel that dries his hands the fastest? [1]

- (b) Give a reason for your answer in (a). [1]

	2
--	---

(Go on to the next page)

38 Travis took four objects, A, B, C and D, and placed two objects at a time on the balance, as shown below.

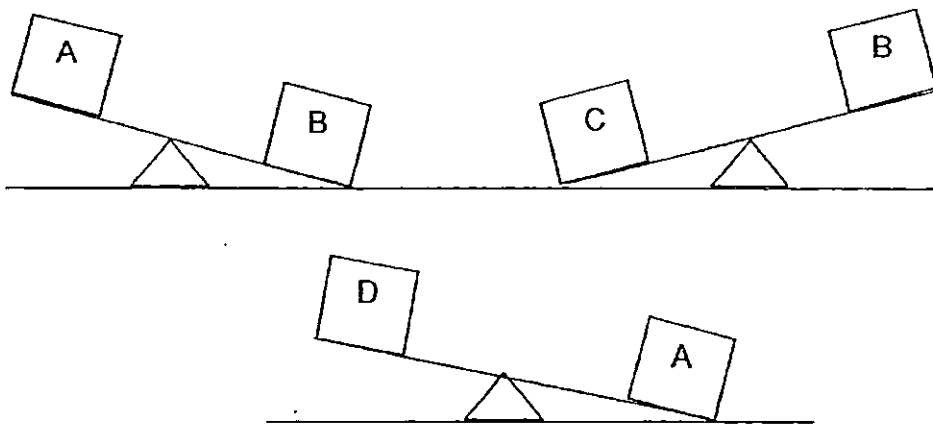

(a) Box _____ has the biggest mass. [1]

(b) Travis then placed object B and D on the balance. Identify B and D by writing **B** and **D** in the boxes. [1]

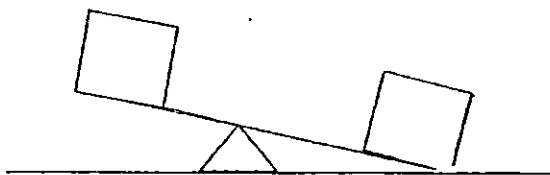

39 Alan used the electrical method to magnetise an iron nail.

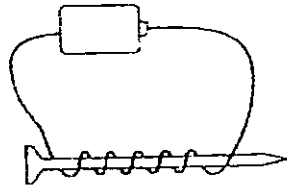

(a) Suggest one way to increase the magnetic strength of the electromagnet. [1]

(b) Alan placed the magnetised nail on top of a box of thumbtacks.

Put a (✓) in the box where it would attract the most number of thumbtacks. [1]

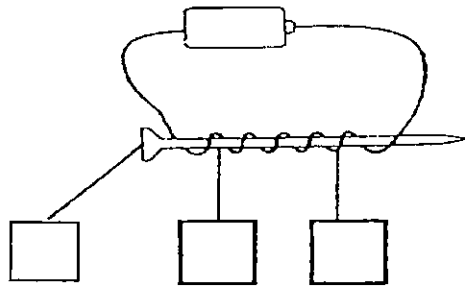

Electromagnets are used in scrap iron cranes where they are able to attract scrap metal from a pile of objects as shown in the picture below.

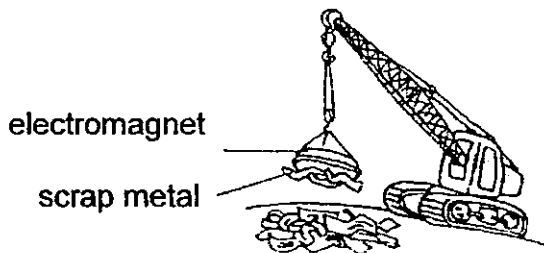

(c) What will happen to the scrap metal if the crane operator turns off the electricity? [1]

40 Rachel sets up an experiment using three ring magnets as shown below.

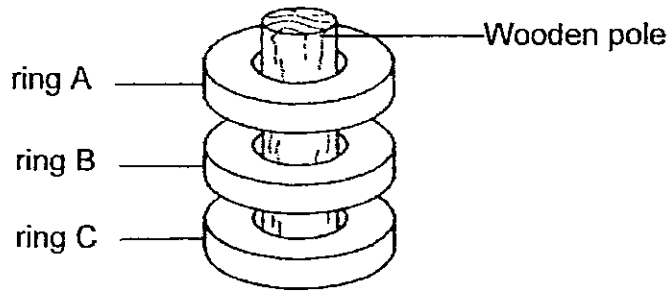

(a) Explain why the ring magnets are floating above one another. [1]

(b) Which magnet should Rachel turn so that all the three ring magnets will touch each other? [1]

Rachel wants to find out if object X is a magnet. She places one end of object X near to one side of the ring magnet.

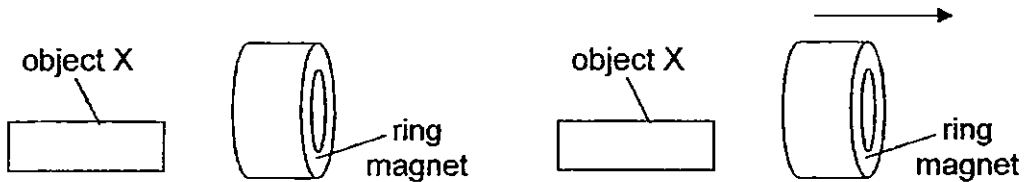

Before: Place object X near to the ring magnet

After: Ring magnet moves away from object X

(c) Rachel concluded that object X is a magnet. Do you agree with her? Give a reason. [1]

41 A magnet that was wrapped in an aluminium foil was placed near a steel thumbtack.

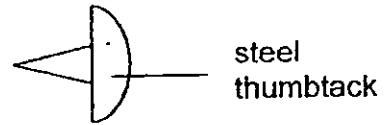
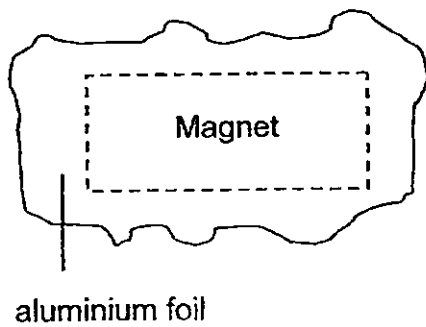

(a) What will happen when the wrapped magnet is brought near the steel thumbtack? [1]

(b) Name one property of the aluminium foil that allowed for the observation to be made in (a). [1]

(c) State one property of magnet that is demonstrated in Ali's experiment. [1]

- 42 Keanu filled a beaker of 40 cm^3 with marbles to the brim. He filled another beaker of 20 cm^3 with sand to the brim.

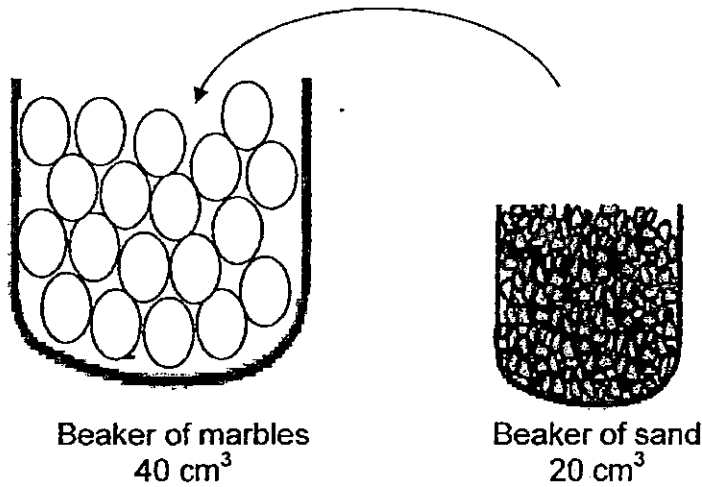

He then poured the sand into the beaker of marbles and realized that the beaker with marbles can hold all the sand.

- (a) Give a reason why the beaker with marbles can hold all the sand. [1]

- (b) Name the state (solid, liquid or gas) of the marbles and sand. [1]

Items	State of matter
Marbles	
Sand	

43 Yan Yan has two containers, X and Y, of the same material but different capacity.

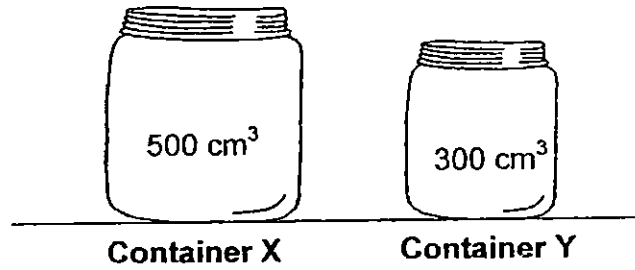

She pumped 200 cm³ of air into the two containers and measured the volume of air in both containers.

(a) In the boxes provided, write down the volume of air in each container. [1]

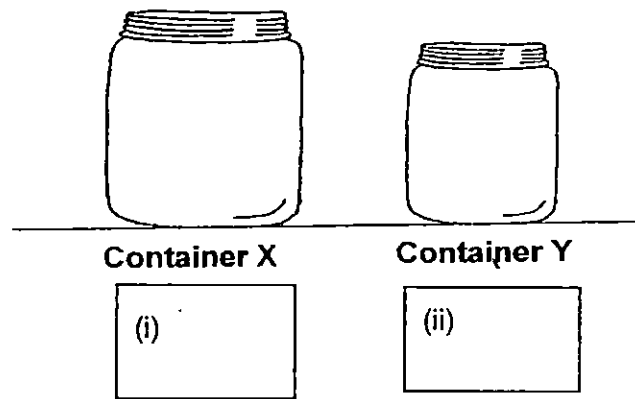

(b) What property of air does this experiment show? [1]

	2
--	---

(Go on to the next page)

44 Patrick filled a balloon with some air and put it into a container filled with water as shown below.

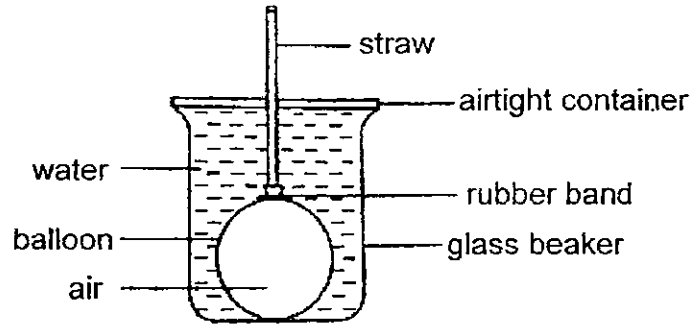

(a) Patrick wanted to blow in more air into the balloon through the straw to increase the size of the balloon.

Is it possible for him to do that? Give a reason your answer. [1]

(b) Without removing the balloon from the container, what can Patrick do so that he can blow in more air to increase the size of the balloon? [1]

End of Booklet B

	2
--	---



EXAM PAPER 2015

LEVEL : PRIMARY 4

SCHOOL : MARIS STELLA HIGH SCHOOL (PRIMARY)

SUBJECT : SCIENCE

TERM : SA1

Q 1	Q 2	Q 3	Q 4	Q 5	Q 6	Q 7	Q 8	Q 9	Q 10
3	2	4	2	4	3	4	2	2	4
Q 11	Q 12	Q 13	Q 14	Q 15	Q 16	Q 17	Q 18	Q 19	Q 20
4	3	4	4	3	3	4	3	4	4
Q 21	Q 22	Q 23	Q 24	Q 25	Q 26	Q 27	Q 28	Q 29	Q 30
4	2	3	3	2	2	3	2	3	2

Q31a (i) Animal A has a long tail but animal B does not have a long tail.

Q31a (ii) Animal A has 4 legs but animal B has 4 legs.

Q31b Insects

Q31c. It has 6 legs

Q32a. X: Give birth to young alive.

Q32a. Y: Lay eggs

Q32b. X

Q33a. Animal A has a e stage life cycle and it lays it eggs on land.

Q33b. Animal B : cockroach

Q33c. egg → larva → pupa → adult

Q34a. Set up B

Q34b. Set up B has moist cotton, if you want if to grow, you need to have air, food and water. Water is the same as moist.

Q34c. Seed leaves

Q34d. Roots

Q35a. A C D B

Q35b. (i) C

Q35b (ii) B

Q35b (iii) D

Q35c (iv) A

Q36a: (i) number of times the magnet was dropped

Q36a (ii) number of paper clips attracted

Q36b. To find out if the number of times he drop the magnet will affect the number of paper clips attracted.

Q36c. The height the magnet is dropped

Q37a. R

Q37b. It is the most absorbent. It has absorbed the most amount of water in the experiment.

Q38a. Box C

Q38b. SEE PICTURE

Q39a. Put more batteries

Q39b. SEE PICTURE

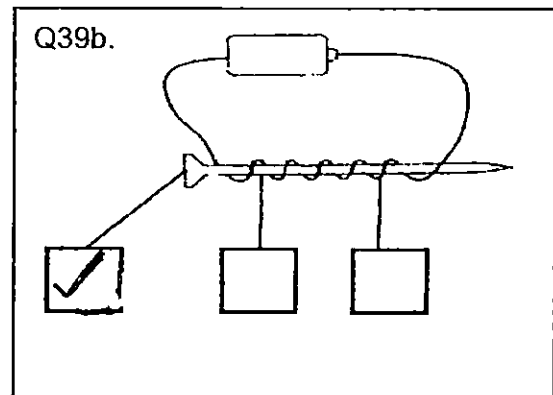
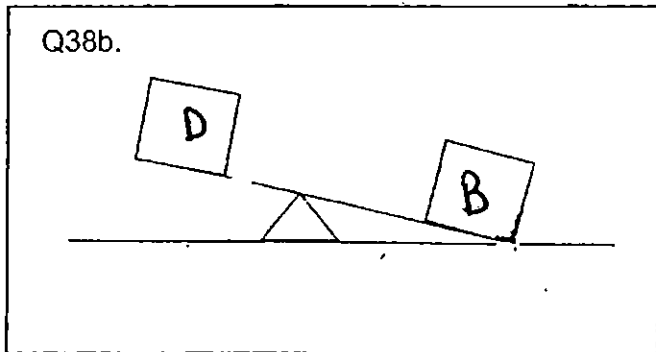

Q39c. The scrap metal will drop on the ground

Q40a. The like poles of the tree ring magnets are facing each other and repelling each other.

Q40b. Unlike poles attract.

Q40c. Yes. Object X is repelling from the ring magnet. Only magnets repel.

Q41a. The steel thumbtack will move towards the magnet.

Q41b. Aluminum Q41c. Magnetism can pass through non magnetic materials.

Q42a. The sand will occupy the space in between the marbles.

Q42b. marbles – solid Q42b. sand – solid

Q43a. Container X : 500cm^3 Q43a. Container Y : 300cm^3

Q43b. Air has no definite volume and can be compressed.

Q44a. Water is taking up the space in the glass beaker and water cannot be compressed because it has a definite volume.

Q44b. Remove the cover

THE END