



AI TONG SCHOOL

2016 MID-YEAR EXAMINATION PRIMARY FOUR SCIENCE

DURATION: 1 hour 45 minutes

DATE: 10 May 2016

INSTRUCTIONS

Do not open the booklet until you are told to do so.

Follow all instructions.

Answer all questions.

Name : _____ ()

Class : Primary 4 _____

Parent's Signature : _____

Date : _____

Booklet A	56
Booklet B	44
Total	100

Section A (30 x 2 marks)

For each question from 1 to 30, four options are given. One of them is the correct answer. Make your choice and shade the correct oval (1, 2, 3 or 4) on the Optical Answer Sheet.

1. Which of the following statements are true about bacteria?

- A Bacteria are harmful to us.
- B Bacteria are very tiny living things.
- C Bacteria can make their own food.
- D Bacteria can only be seen using a microscope.

- (1) A and B only
- (2) A and C only
- (3) B and D only
- (4) A, B and D only

2. Look at the classification table carefully.

Living Things			
Animals		Plants	
Q	R	S	T
Elephant	Grasshopper	Moss	Papaya Plant

Q, R, S and T are headings for each group. What can Q, R, S and T be?

	Q	R	S	T
(1)	Live on land	Live in water	Fungi	Flowering Plant
(2)	Mammal	Insect	Non-flowering plant	Flowering plant
(3)	Has hair	Has six legs	Cannot bear flowers	Can bear flowers
(4)	Has no wings	Has wings	Cannot make food	Can make food

3. Study the life cycles shown below.

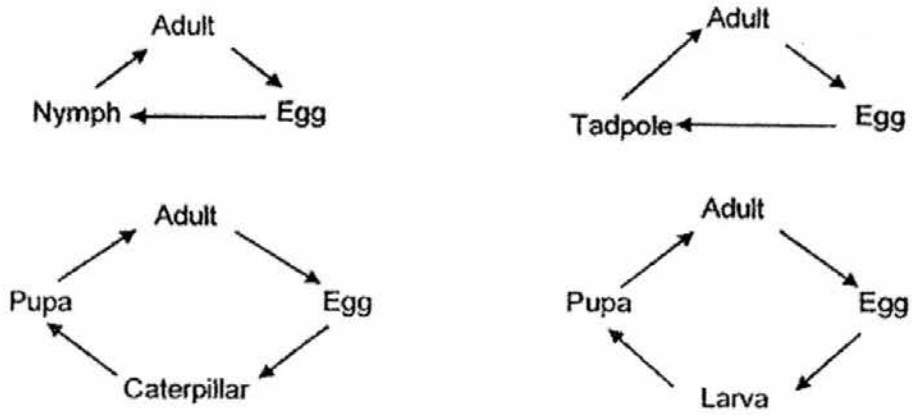

Based on the life cycles given above, which one of the following statements are true?

- (1) All the adults are insects.
- (2) All the animals develop from eggs.
- (3) All the animals have 4 stages in their life cycles.
- (4) All the young in the above cycles look like the adult.

4. The graph below shows the number of days each stage of the life cycle of Insect H would last.

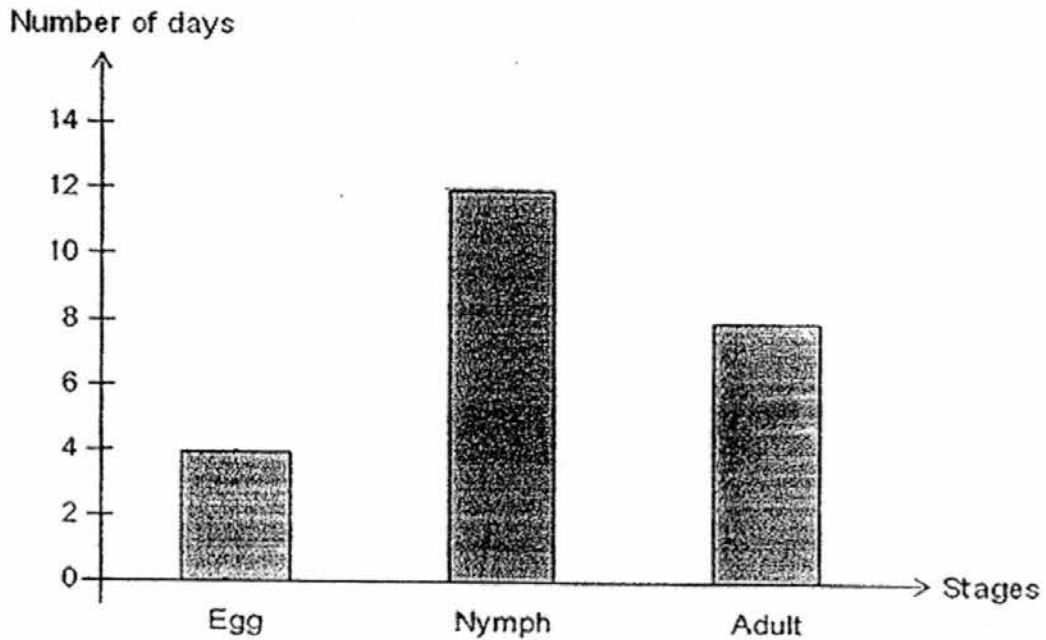

Based on the graph, which one of the following information about Insect H is **correct**?

- (1) Insect H lived on land.
- (2) The insect survived for 16 days only.
- (3) The young of Insect H does not moult.
- (4) After the egg hatched, the insect took 12 days to become an adult.

5. The following statements show different stages in the growth of a seed. Which of the following shows the correct order of the stages of seed growth, starting with the earliest stage?

- A The root appears.
- B The seed leaf becomes smaller.
- C The shoot grows out from the seed.
- D The seed increases in size and the seed coat splits.

- (1) A → D → B → C
- (2) A → B → C → D
- (3) D → C → B → A
- (4) D → A → C → B

6. Harry wanted to carry out an experiment to find out if amount of light affects the growth of his water plants.

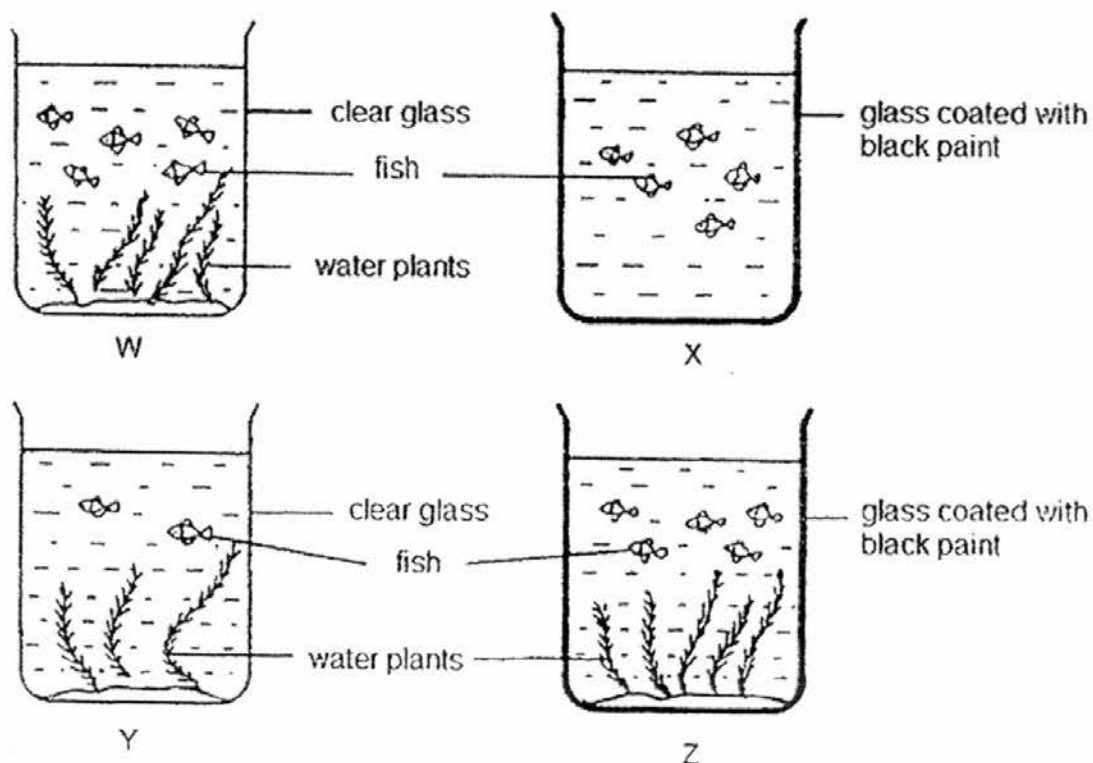

He prepared 4 set-ups, W, X, Y and Z as shown above. Which two set-ups should he use to carry out his experiment?

- (1) W and X
- (2) X and Y
- (3) W and Z
- (4) Y and Z

7. Study the diagram of the human digestive system below.

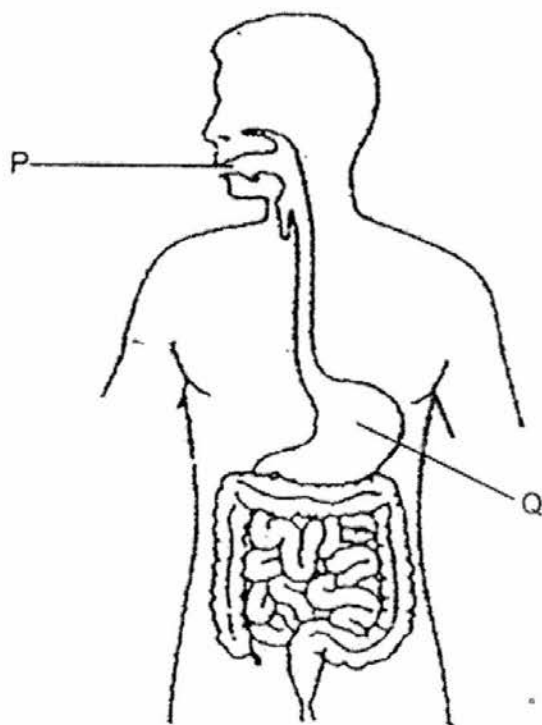

Which of the following correctly describes the functions of parts P and Q of the human

	Part P	Part Q
(1)	Saliva softens and digests the food.	Digested food is absorbed into the blood.
(2)	Food is chewed and ground into smaller pieces.	Food is digested further and mixed with other digestive juices.
(3)	Digested food is absorbed into the blood.	Chewed food is delivered to other parts of the digestive system.
(4)	Food is digested further and mixed with other digestive juices.	Digestion begins here.

8. The chart below shows how some body organs are classified according to the human body system that they belong to.

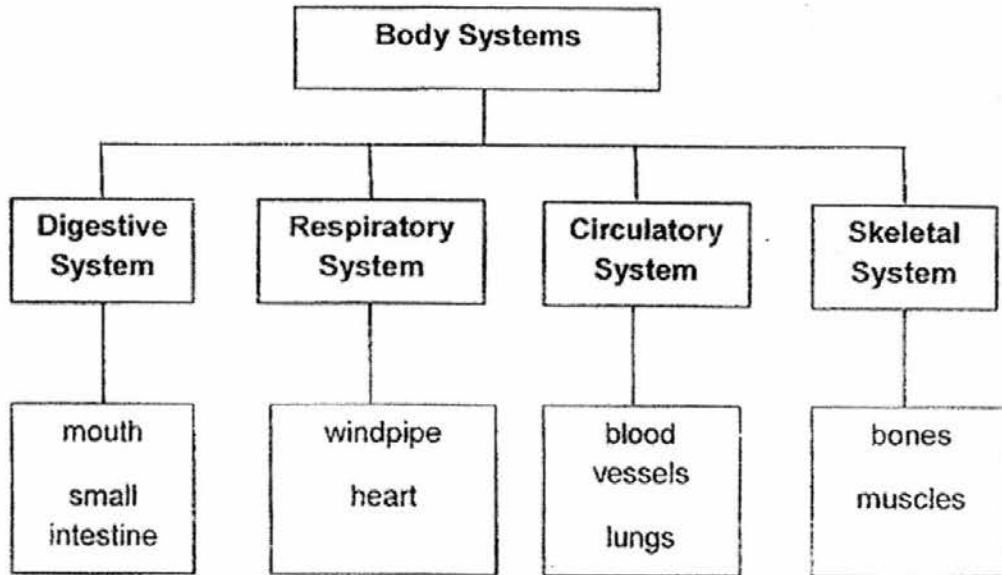

Which organs are wrongly matched to the body system?

- (1) mouth and muscles only
- (2) windpipe and lungs only
- (3) heart, lungs and muscles only
- (4) mouth, lungs and blood vessels only

9. What will happen if the part labelled 'X' in the diagram of the human digestive system below is not working properly?

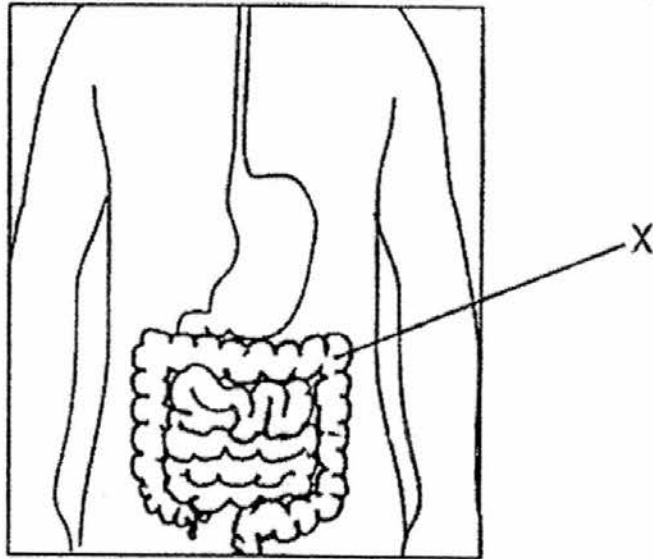

- (1) Digestion cannot start.
- (2) Digested food will be passed out.
- (3) Water from undigested food is not absorbed into the body.
- (4) Digestive juices will not be released for the digestion of food.

10. Jimmy had fish and chips for lunch. A, B, C, D and E represent parts of the digestive system in sequence. The amount of digested food present at the start of each part is shown in the graph below.

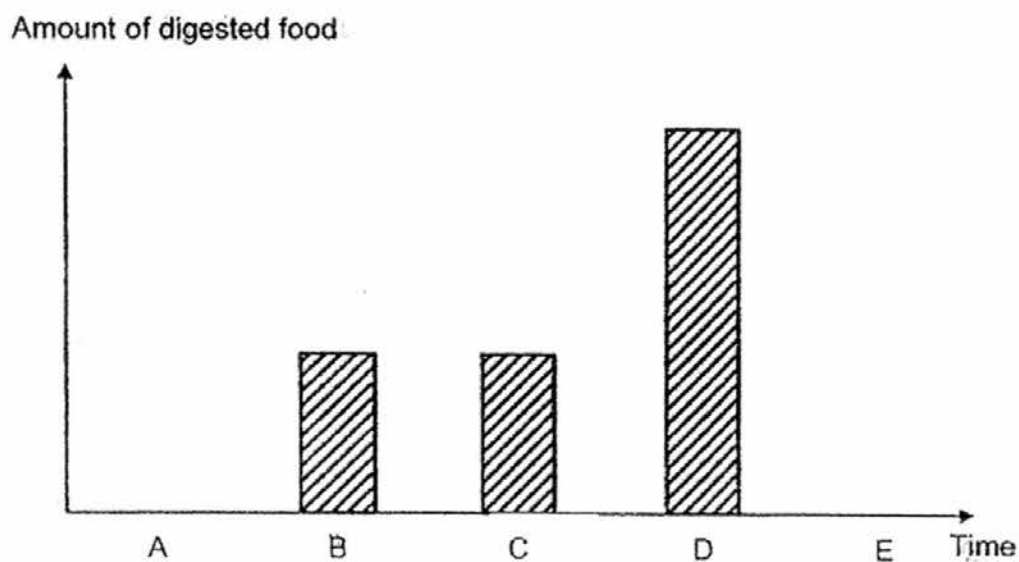

Based on the graph, which of the following best represents B, C and E?

	B	C	E
(1)	Mouth	Stomach	Small Intestine
(2)	Gullet	Stomach	Large Intestine
(3)	Stomach	Small Intestine	Large Intestine
(4)	Small Intestine	Large Intestine	Rectum

11. The diagram below shows some characteristics of four materials, A, B, C and D.

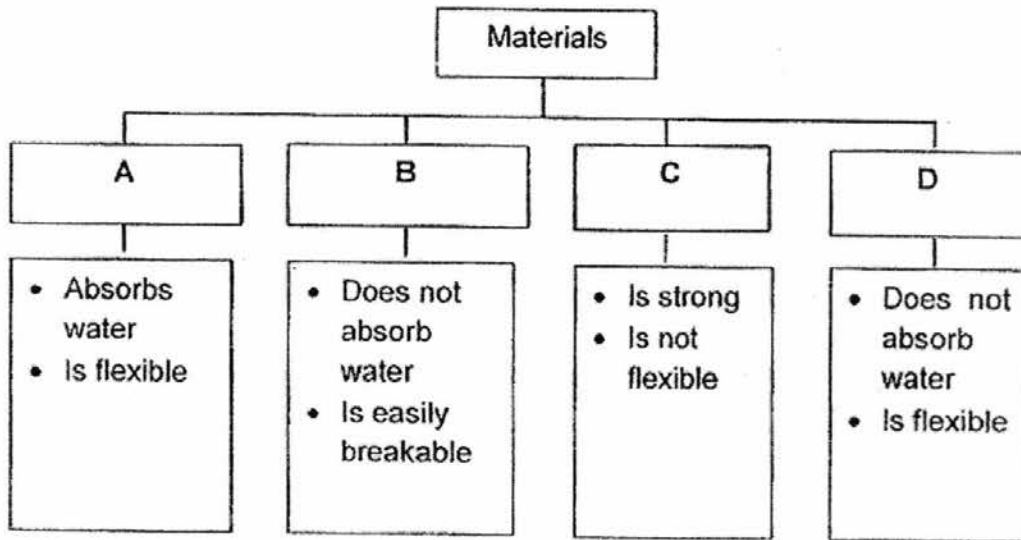

The diagram below shows a car with its tyre labelled.

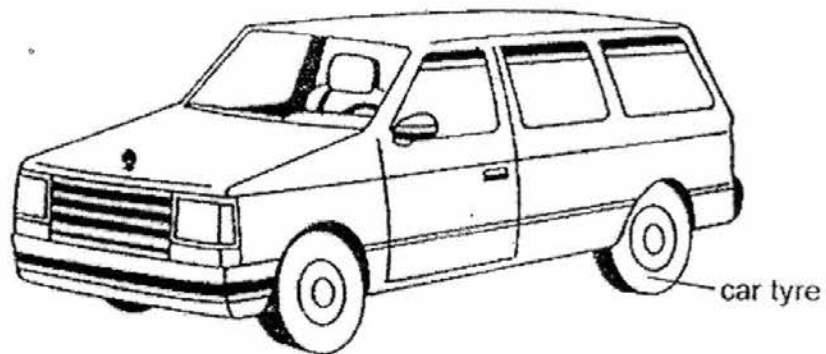

Which of the above materials could a car tyre be made of?

- (1) A
- (2) B
- (3) C
- (4) D

12. Tim carried out an experiment with three materials, P, Q and R of the same size and shape. He dropped each material from a height of 50cm and observed if the material broke when it reached the ground. If the material did not break, he dropped it from an even higher height.

The results of his experiment are shown below.

Material	Height from which material is dropped			
	50cm	1m	1m 50 cm	2m
P	Did not break	Broke	--	--
Q	Did not break	Did not break	Did not break	Did not break
R	Did not break	Did not break	Did not break	Broke

Which of the following is the changed variable of this experiment?

- (1) Size of material
 - (2) Type of material
 - (3) Whether the material broke or not
 - (4) Height from which material is dropped
13. Teddy wanted to find out whether the thickness of a material would affect the amount of water it could absorb. He carried out an experiment and recorded the results in the table below.

Piece	Thickness of Material X	Amount of water absorbed by material
A	1cm	15ml
B	2cm	30ml
C	4cm	65ml
D	5cm	80ml

From the table, what is the relationship between the thickness of the material and the amount of water absorbed?

- (1) There is no change to the amount of water being absorbed.
- (2) The thicker the material X, the more the amount of water absorbed.
- (3) The thinner the material X, the more the amount of water absorbed.
- (4) The thicker the material X, the lesser the amount of water absorbed.

14. Study the flowchart below.

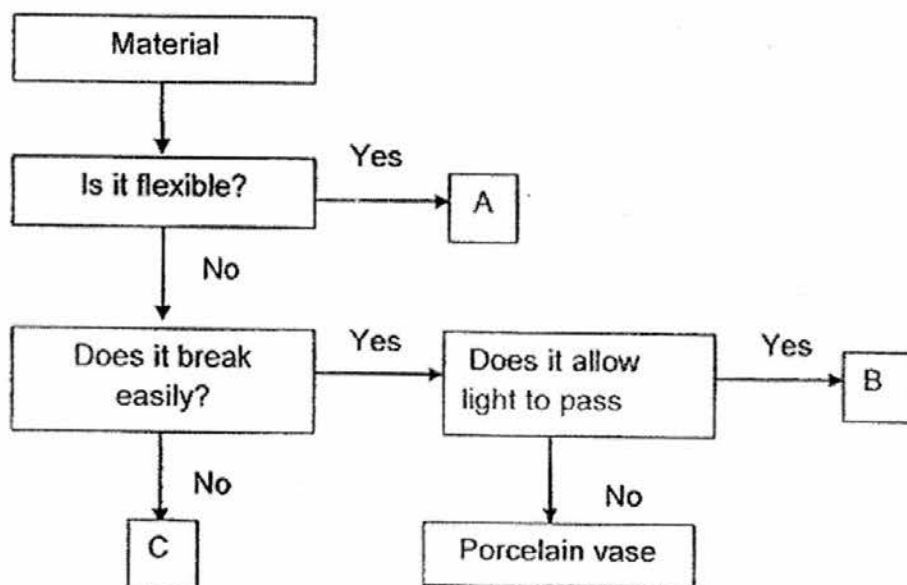

Which of the letters in the flowchart correctly represents a wine glass, a face towel and a plastic water bottle?

	Wine glass	Face towel	Plastic water bottle
(1)	C	A	B
(2)	C	B	A
(3)	B	A	C
(4)	B	C	A

15. The table below shows the properties of four things, A, B, C and D.

Properties	A	B	C	D
Can be seen	✓		✓	✓
Occupies space	✓	✓		✓
Has a definite shape	✓			
Has a definite volume	✓			✓
Can be compressed		✓		

Which one of the following represents milk?

- (1) A
- (2) B
- (3) C
- (4) D

16. Which of the following objects are **not** matter?

- A shadow
- B oxygen
- C toothpaste
- D lightning
- E computer

- (1) A and D only
- (2) C and D only
- (3) A, B and D only
- (4) B, C and E only

17. Jerry wanted to find out the volume of a stone and a piece of styrofoam. The diagrams below show what he did.

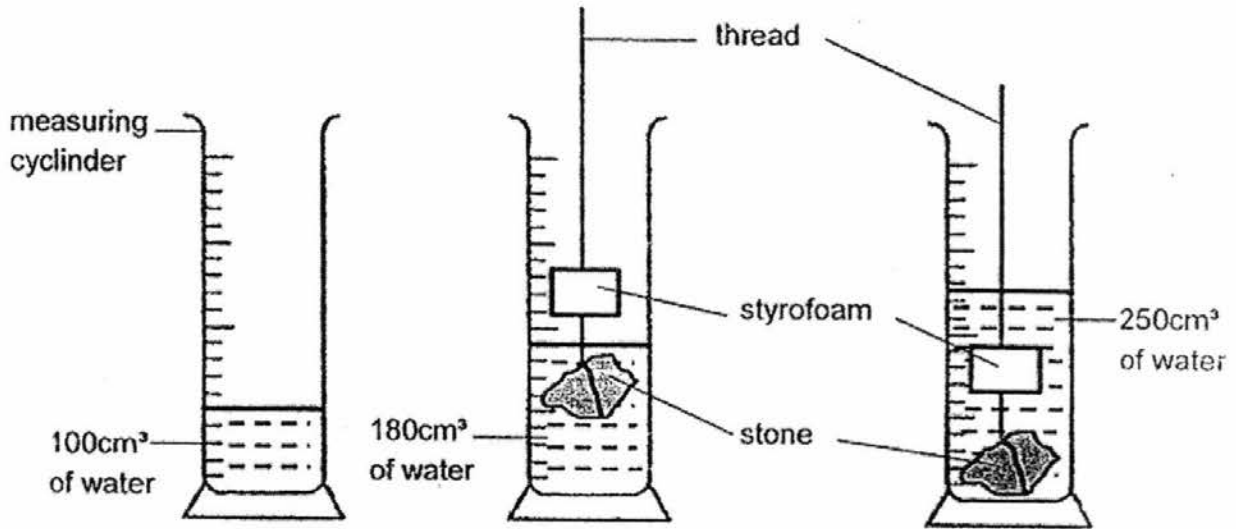

Based on the diagrams, which one of the following is the correct volume of the stone and the styrofoam?

	Volume of stone (cm ³)	Volume of styrofoam (cm ³)
(1)	70	250
(2)	80	70
(3)	80	100
(4)	180	250

18. The diagram below, not drawn to scale, shows a syringe with a capacity of 300cm^3 .

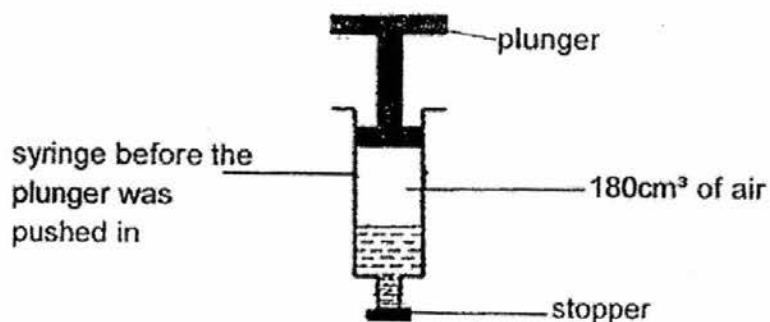

Assuming that there was no water leakage, which of the following shows the possible volume of air and water after the plunger was pushed in?

	Volume of air (cm^3)	Volume of water (cm^3)
(1)	180	300
(2)	120	180
(3)	180	120
(4)	150	120

19. The diagram below shows Sally pumping air into a balloon. The balloon becomes bigger.



What does this tell us about air?

- (1) Air has mass.
- (2) Air can be seen.
- (3) Air occupies space.
- (4) Air can move about.

20. When air is let out of one of the inflated balloons, the balance tilts as shown in the diagram below.

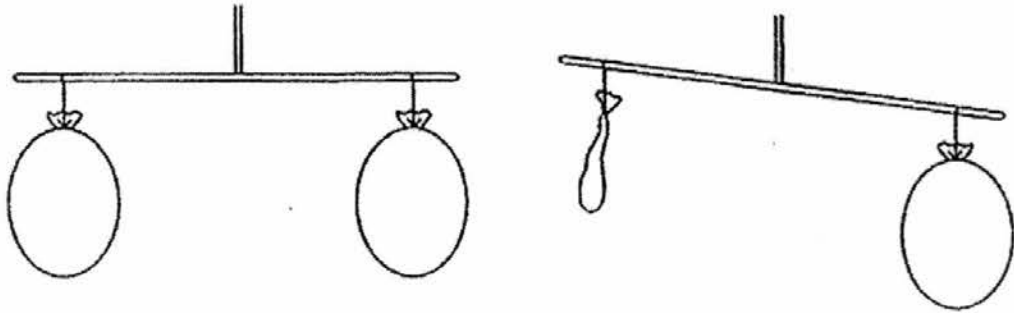

What does this tell us?

- (1) Air has mass.
 - (2) Air occupies space.
 - (3) Air causes things to move.
 - (4) A balloon has no mass until it is inflated.
21. To warm up a bottle of milk for her child, a mother placed the bottle of milk into a basin of hot water as shown in the diagram below.

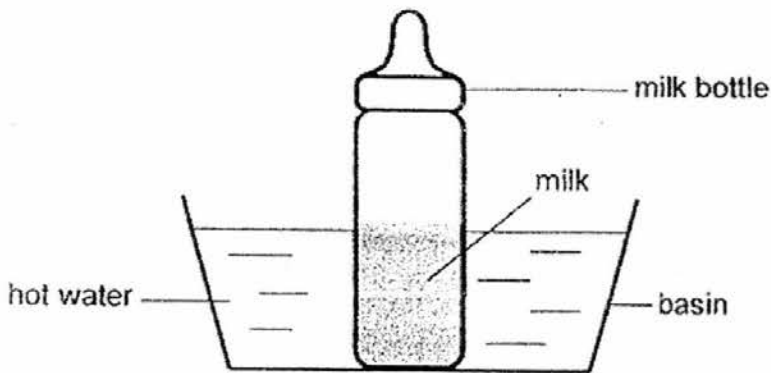

Which of the following is the heat source?

- (1) Milk
- (2) Hot water
- (3) Milk bottle
- (4) Surrounding air

22. Which of the following is a heat source but not a light source?

- (1) Hair dryer
- (2) Basketball
- (3) Torchlight
- (4) Glow-in-the-dark sticker

23. Jim has four beakers of water as shown in the diagrams below.

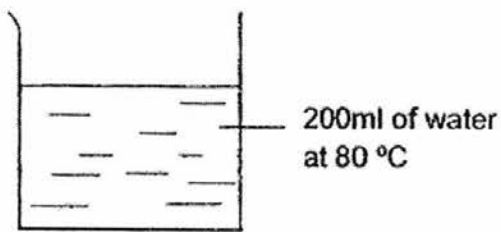

A

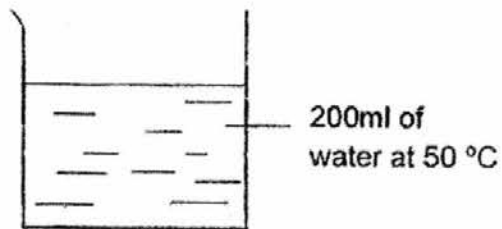

B

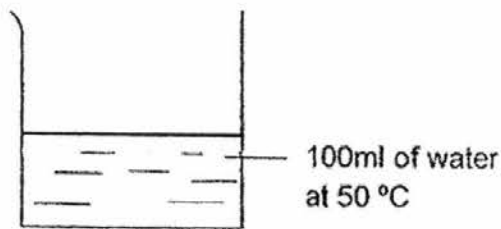

C

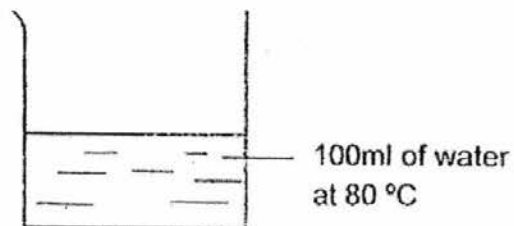

D

Which of the following statements is correct?

- (1) All the beakers of water have the same amount of heat.
- (2) The water in Beaker C has less heat than the water in Beaker B.
- (3) The water in Beaker A has the same amount of heat as the water in Beaker B.
- (4) The water in Beaker A has the same amount of heat as the water in Beaker D.

24. Which one of the following statements is false?

- (1) Light energy enables us to see.
- (2) Glass allows light to pass through it.
- (3) Only objects with shiny surfaces will reflect light.
- (4) A shadow is formed when light is blocked by an object.

25. Which of the following diagrams shows the correct direction that light travels to enable a person to see a rubber ball in a room?

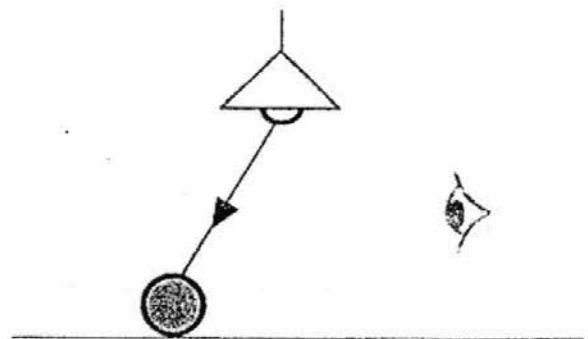
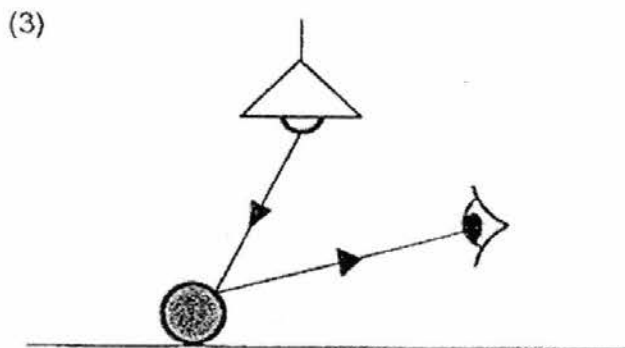
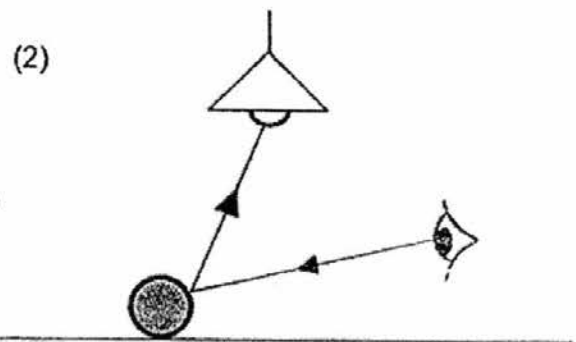
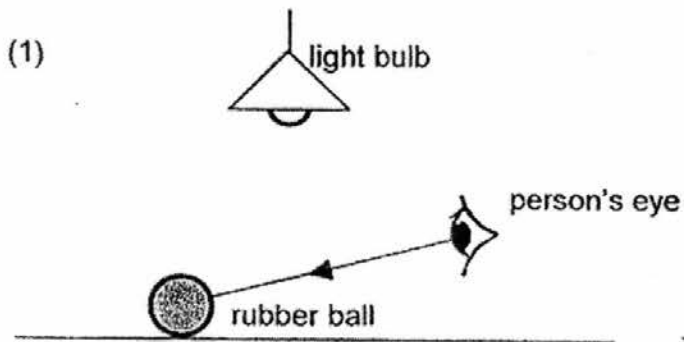

26. The experiment shown below was carried out in a dark room.

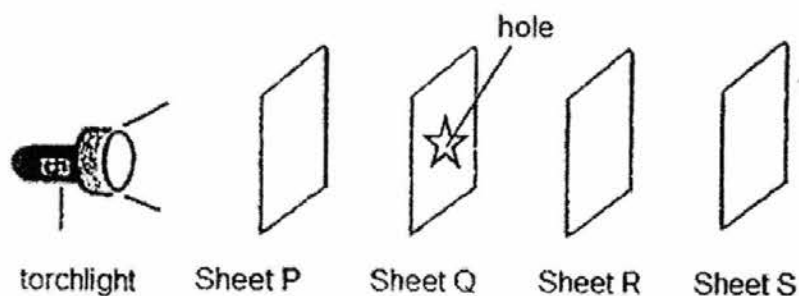

Sheets P, Q, R and S were made of different materials and were arranged in a straight line. Sheet Q had a star-shaped hole cut out from it. The torchlight was switched on and a bright star-shaped patch of light was seen on sheet R only.

Which one of the following correctly describes the properties of the materials that sheets P, Q, R and S are most likely made of?

	Allows light to pass through	Does not allow light to pass through	Not possible to tell
(1)	R	Q and S	P
(2)	Q	P	R
(3)	P	Q and R	S
(4)	P and Q	R	S

27. The cup below is able to cast shadows of different shapes.

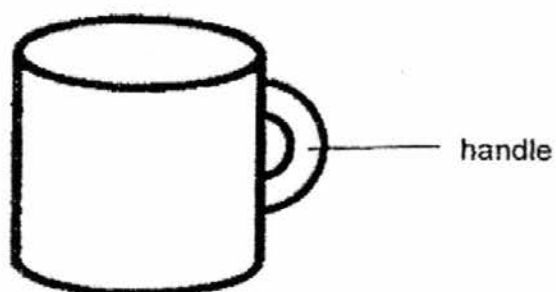

Cup

If Kris shines a torch at the cup from different directions, which one of the following shadows would not be formed by the cup?

(1)



(2)



(3)



(4)



28. The diagram below shows a lamp hanging from the ceiling that was made to swing from position A to D. There is a pole standing upright on the floor just below the lamp.

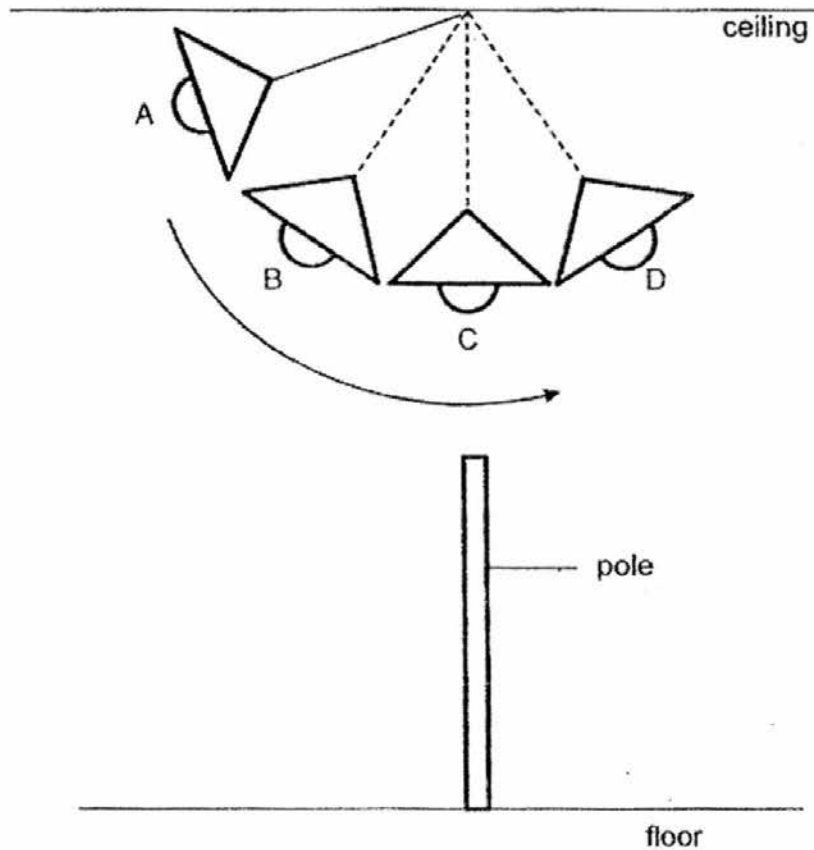

Which of the following statements about the shadows of the pole cast on the floor is correct as the lamp swings from A to D?

- (1) The length of the shadow keeps increasing.
- (2) The length of the shadow keeps decreasing.
- (3) The shadow was longest when the lamp was at position D.
- (4) The shadow was longest when the lamp was at position A.

Name: _____ ()

MYE 2016

Class P4 ()

Section B: 44 marks

Read the questions carefully and write down your answers in the spaces provided.

29. Mary placed two similar grasshoppers in each of the two separate glass containers as shown in the diagram below.

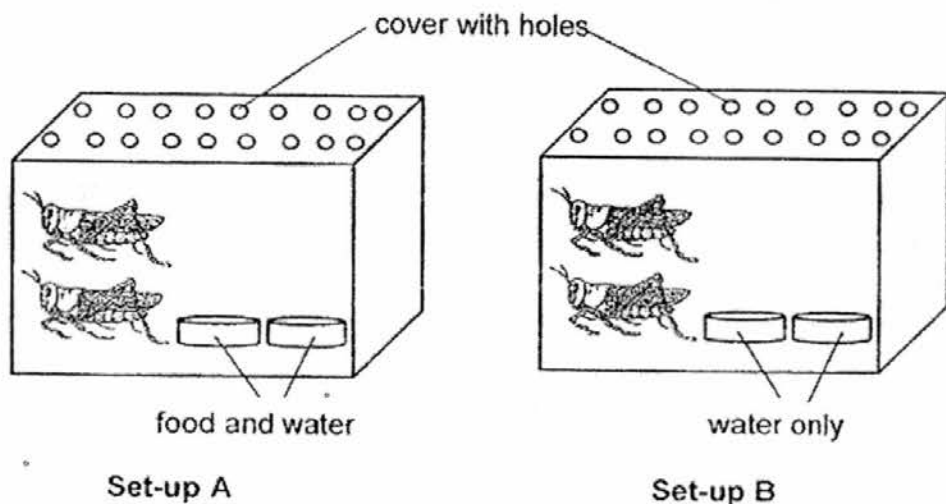

- (a) What was the aim of Mary's experiment? Place a tick (✓) in the table given below.

Aim of the experiment	Tick (✓)
To find out if the presence of air affects the survival of grasshoppers.	
To find out if the presence of food affects the survival of the grasshoppers.	
To find out if the presence of water affects the survival of the grasshoppers.	

[1]

- (b) After one week, Mary observed that the grasshoppers in set-up B had died. Explain why this had happened.

[1]

Question continues on the next page.

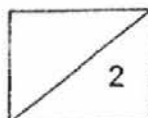

- 29 (c) Mary observed that the number of grasshoppers in Set-up A increased after two weeks. State the characteristic of living things which the grasshoppers were showing. [1]

30. (a) Complete the diagram below to show the life cycle of a chicken. [2]

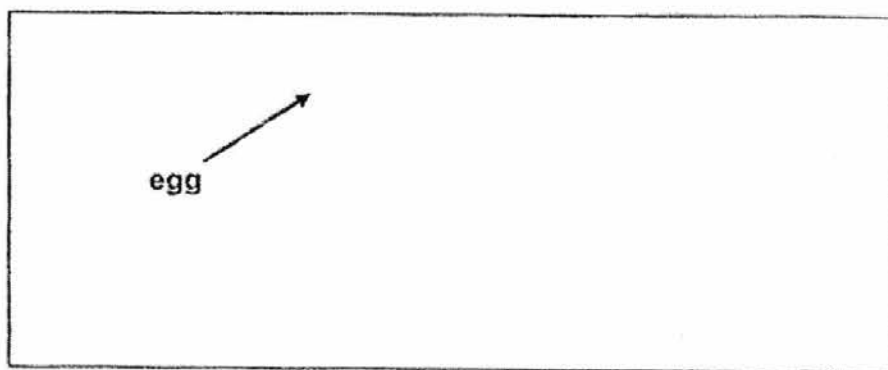

- (b) State one similarity between the life cycle of a cockroach and a chicken. [1]

- (c) Barbara noticed that the snails in her garden lay many eggs at a time. How does laying many eggs at a time help the snails? [1]

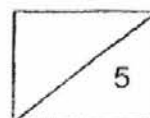

31. The diagram below shows a flowering plant.

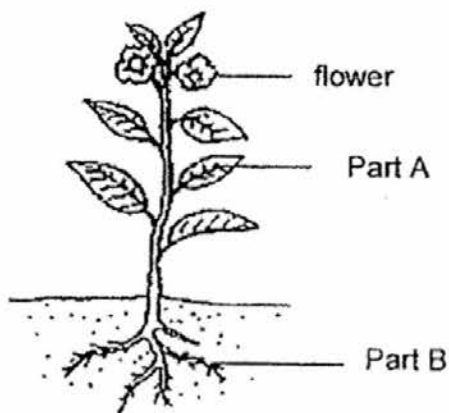

- (a) What do the flowers of the plant develop into? [1]

- (b) Give a function of part A. [1]

- (c) State how part B is useful to the plant during stormy weather. [1]

- (d) How does the number of part B of the plant affect the amount of water absorbed by the plant? [1]

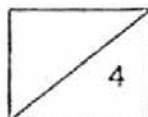

32. The diagram below shows the human digestive system,

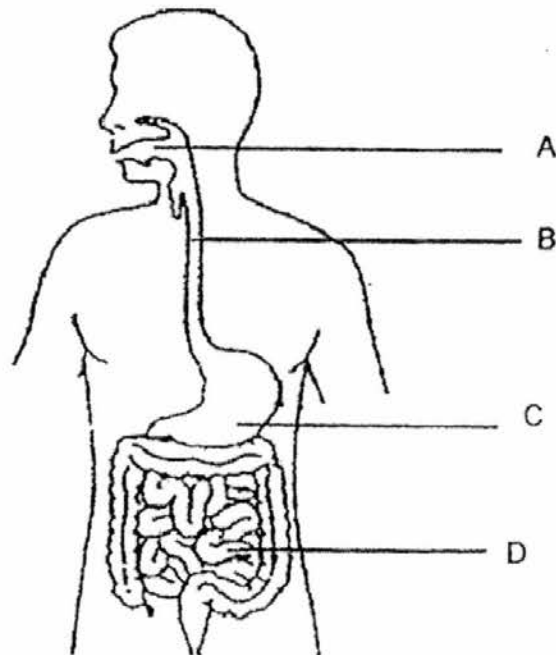

- (a) In which part(s) of the human digestive system, A, B, C and/or D, does digestion not take place? Explain your answer. [1]

- (b) What is the difference between the function of Part C and the function of Part D? [1]

- (c) There are teeth in part A of the digestive system. What is the function of teeth? [1]

Question continues on the next page.

Kelly used some scrap materials to make a model of the digestive system as shown below.

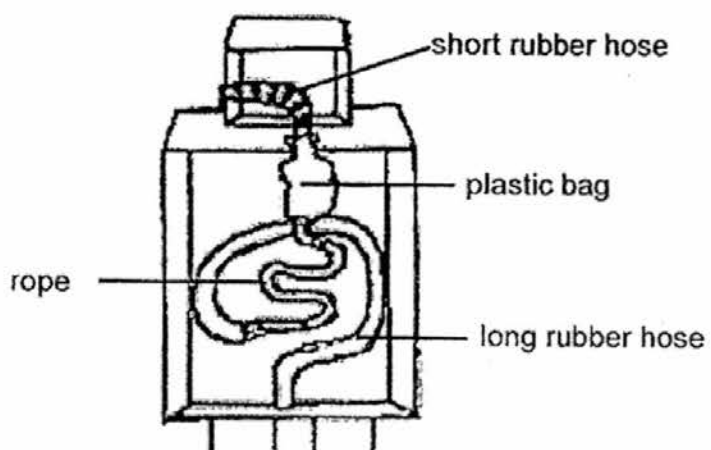

(d) Give the names of the parts of the digestive system represented by the following two scrap materials. [1]

(i) Long rubber hose: _____

(ii) Plastic bag: _____

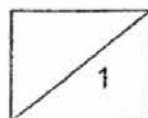

33. Jackson enjoys looking at fish as they swim freely in a tank. He went into a shop to look for a suitable tank for some colourful guppies he had just bought as pets.

(a) Suggest a material that the tank could be made up of to meet his needs? Explain your choice. [1]

Jackson bought a suitable tank and went home. He placed the tank on four supports as shown in the diagram below.

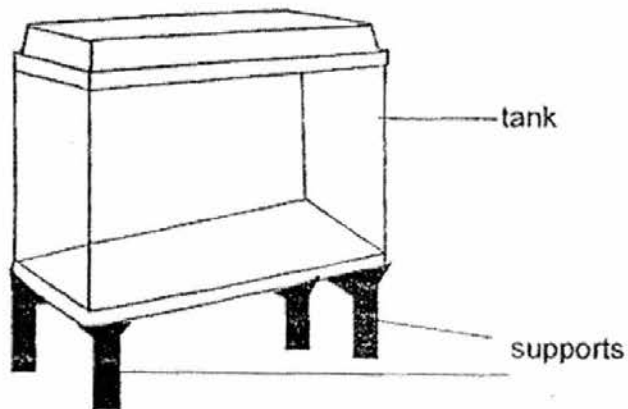

(b) State one property that these supports must have. Explain your answer [1]

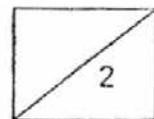

34. Ben set up an experiment as shown below to find out how much water three pieces of fabric, A, B and C can absorb.

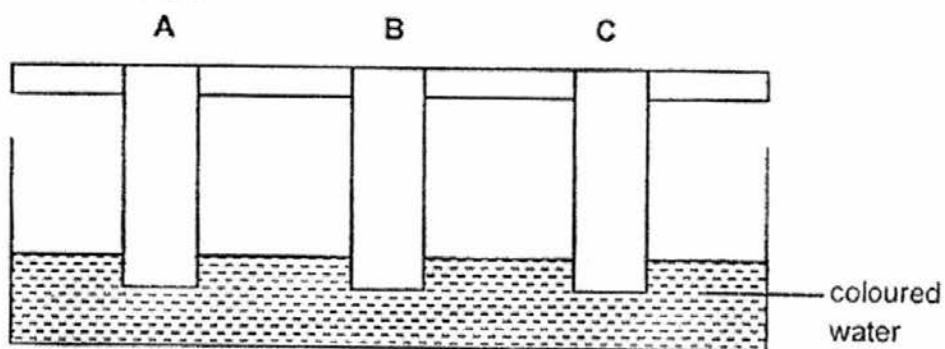

The distance that the coloured water travelled up each fabric is recorded in the table below.

	A	B	C
Distance that coloured water travelled up fabric	5cm	15cm	10cm

- (a) In the diagram below, a line has been drawn on fabric C to show where the coloured water travelled up to at the end of the experiment.

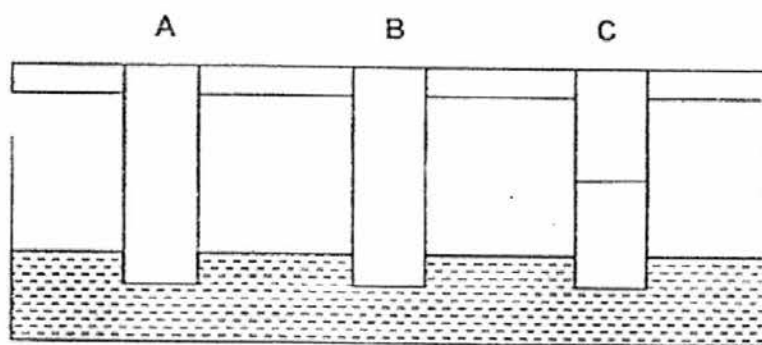

In the same diagram above, draw a line on fabric A and B to also show where the coloured water travelled up to for both fabrics at the end of the experiment. [1]

- (b) Which of the above fabric, A, B, or C would you choose to dry your dishes? Explain your answer. [1]

35. James had two round objects P and Q.



- (a) State a difference between the volume of P and the volume of Q. [1]

James then put objects P and Q on a beam balance and the diagram below shows what happened to the beam balance.

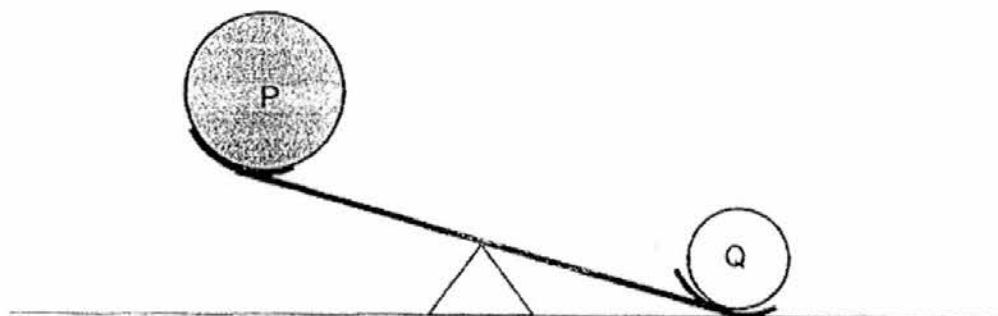

- (b) Based only on the diagram above, what can you conclude about the mass of objects P and Q? [1]

- (c) Which of the following statement(s) is/are true? Put a tick (✓) in the boxes provided if it is true. [1]

Statement	Put a tick (✓) if the statement is true.
A heavier object has more mass than a lighter object.	
A bigger object definitely has more mass than a smaller object.	

36. A displacement can, a measuring cylinder and some water can be used to find the volume of a rock.

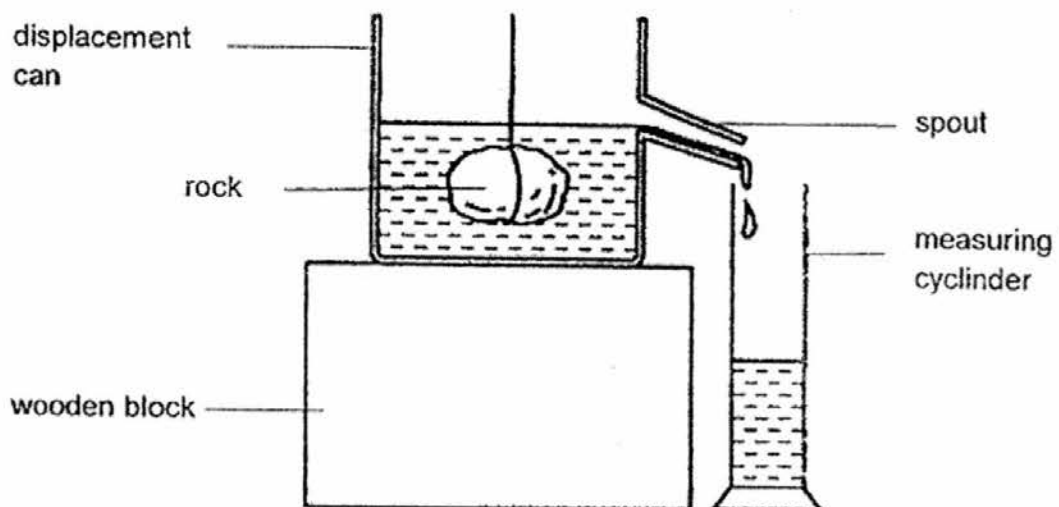

- (a) The steps required to use the above equipment to find the volume of the rock are given below but they are not in order. Write '1, 2, 3 or 4' in the boxes provided to arrange the steps correctly. [2]

Steps to find out volume of rock	Order
Place the measuring cylinder under the spout to contain the water flowing out from the spout.	
Fill the displacement can with water until it starts to flow out from the spout.	
Place your eye at the water level in the measuring cylinder to find the volume of the rock.	
Tie the rock to a string and lower it into the displacement can.	

- (b) Give the property of matter that this method of finding volume uses. [1]

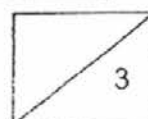

37. A company was trying to invent different types of pillow. Two pillows, X and Y, are shown in the diagram below.



Pillow X

made by putting goose feathers into a cloth bag

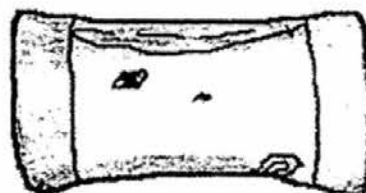

Pillow Y

made completely of wood

- (a) Explain why Pillow X could be flattened when someone sleeps on it but Pillow Y could not? [2]

A new type of pillow, Pillow Z was recently created by the company.



Pillow Z

made by filling a waterproof bag completely with water and sealing it

- (b) The company tells customers that this pillow is very comfortable because it follows the shape of the person's head. What property of water is used in the designing of this pillow? [1]

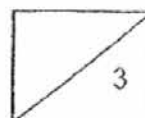

38. Kylie left a cup of hot milo in an air-conditioned room. He recorded the temperature of the hot milo over a period of time as shown in the table below.

Time (minutes)	Temperature ($^{\circ}\text{C}$)
0	()
5	74
10	68
15	36
20	25
25	22
30	22
35	22

- (a) A reading in the data table above is missing. The diagram below shows a thermometer giving the missing temperature of the cup of hot milo when it was first placed in the air-conditioned room.

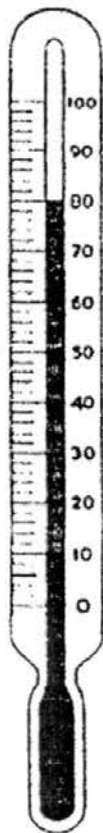

- (a) What is the missing temperature? Answer : _____ [1]

Question continues on the next page.

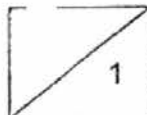

(a) Between which time interval was there a greatest decrease in temperature? [1]

_____ th minute to _____ th minute

() Is the amount of heat in the cup of milo at 25 minutes more, less or the same as the amount of heat in the cup of milo at 35 minutes? Explain your answer. [1]

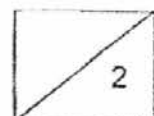

39. Study the experimental set-up shown below. Ray wanted to compare the degree of transparency of materials, A, B, C and D. He set up his experiment in a dark room as shown below.

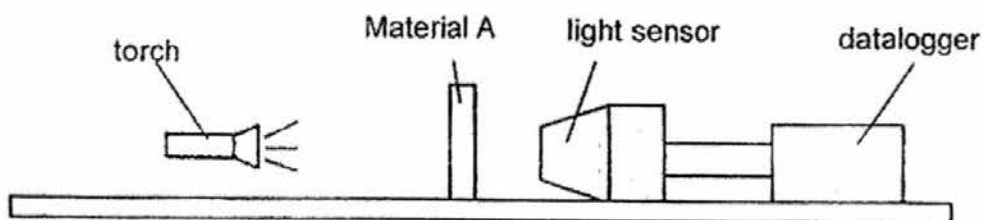

He recorded the amount of light that passed through material A and repeated the experiment with materials B, C and D. The table below shows the results of his experiment.

Material	Amount of light that passed through (lux)
A	110
B	150
C	0
D	90

- (a) What variable was changed and measured in the above experiment? [1]

Variable changed: _____

Variable measured: _____

- (b) Ray had to keep the thickness of all four materials constant. How does thickness of a material affect the amount of light that passed through? [1]

Question continues next page.

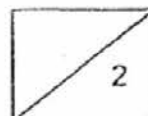

- (c) Based on the results of the experiment, arrange the materials, A, B, C and D, according to their degree of transparency, starting with the most transparent to the least transparent in the table below. [1]

Materials			
Most transparent	→		Least transparent

- (d) Based on Ray's observation, which material is the most suitable to make toilet doors? Explain your answer. [2]

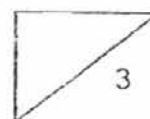

40. Miss Lim had two similar shoeboxes. She put an object into each shoebox. Then, she made a hole on one side of each box and covered the opening of the boxes with a cardboard and clear plastic as shown below. She then shone a torch over each box and peeped in through the hole at the side of the box.

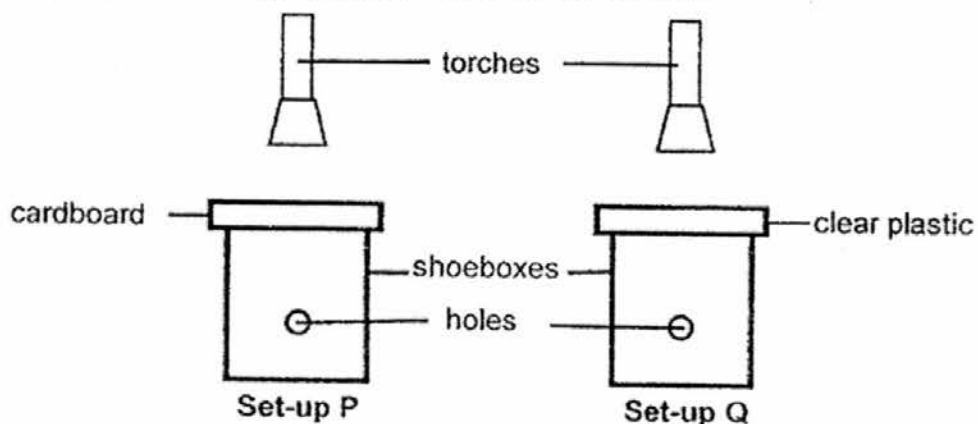

- (a) In which set-up was she able to see the object? Explain your answer. [2]

Miss Lim then took out the object and shone light on it as shown in the diagram below. A shadow was formed on the screen.

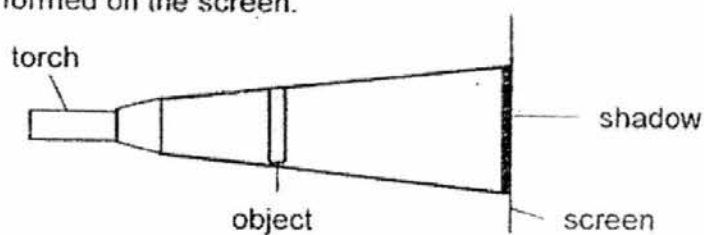

- (b) How is a shadow formed? [1]

Question continues on the next page.

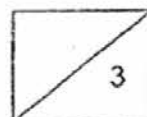

- (c) Based on the diagram above, how should Miss Lim move the object if she wanted to create a smaller shadow? [1]

41. The diagram below shows Jane walking along a narrow corridor and going to make a left turn towards the school hall.

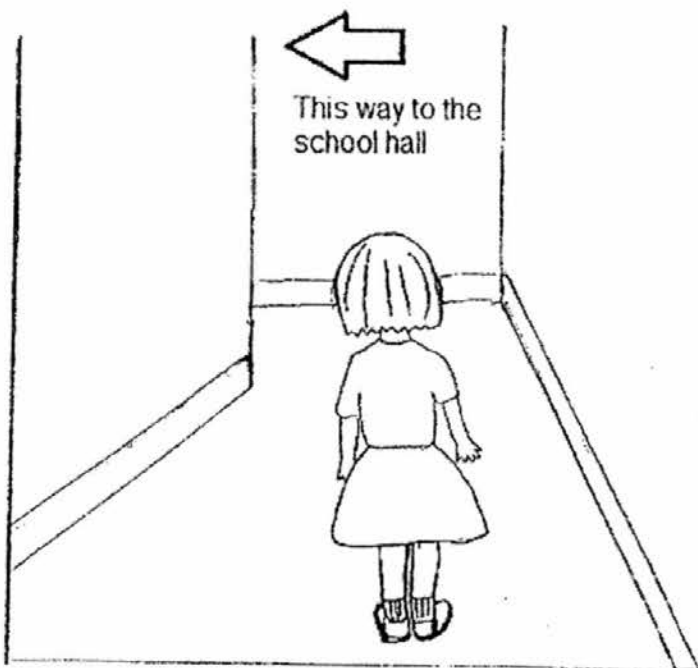

- (a) From where she is standing, she cannot see if there are other students coming towards her from the school hall who might bump into her. What property of light causes this to happen? [1]

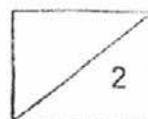

- (b) The diagram below shows the top view of the corridor that Jane is walking along. A mirror has been drawn into the diagram. Draw in light rays to show the direction that light will travel such that Jane can see that Mary is walking towards her from the school hall and be more careful. [2]

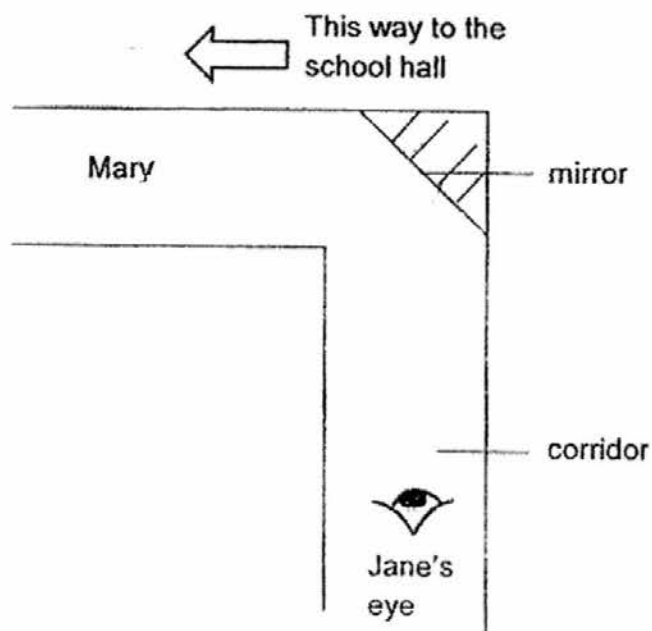

- (c) The school wanted to make the corridor brighter so they installed more light bulbs along the corridor. The students soon complained that they felt very hot walking along that corridor. Give an explanation for this. [1]

END OF PAPER

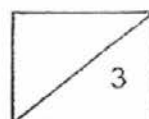

EXAM PAPER 2016 (P4)

SCHOOL : AI TONG

SUBJECT : SCIENCE

TERM : SA1

Q1	Q2	Q3	Q4	Q5	Q6	Q7	Q8	Q9	Q10
3	2	2	4	4	3	2	3	3	2
Q11	Q12	Q13	Q14	Q15	Q16	Q17	Q18	Q19	Q20
4	2	2	3	4	1	2	4	3	1
Q21	Q22	Q23	Q24	Q25	Q26	Q27	Q28		
2	1	2	3	3	3	4	4		

Name: _____ ()

Class: 4 Perseverance

Qu. No.	Suggested Answers (full marks or partial marks)								
29a	<table border="1"> <thead> <tr> <th data-bbox="199 646 861 782">Aim of the experiment</th> <th data-bbox="861 646 973 782">Tick (✓)</th> </tr> </thead> <tbody> <tr> <td data-bbox="199 782 861 986">To find out if the presence of air affects the survival of grasshoppers.</td> <td data-bbox="861 782 973 986"></td> </tr> <tr> <td data-bbox="199 986 861 1134">To find out if the presence of food affects the survival of the grasshoppers.</td> <td data-bbox="861 986 973 1134">✓</td> </tr> <tr> <td data-bbox="199 1134 861 1281">To find out if the presence of water affects the survival of the grasshoppers.</td> <td data-bbox="861 1134 973 1281"></td> </tr> </tbody> </table>	Aim of the experiment	Tick (✓)	To find out if the presence of air affects the survival of grasshoppers.		To find out if the presence of food affects the survival of the grasshoppers.	✓	To find out if the presence of water affects the survival of the grasshoppers.	
Aim of the experiment	Tick (✓)								
To find out if the presence of air affects the survival of grasshoppers.									
To find out if the presence of food affects the survival of the grasshoppers.	✓								
To find out if the presence of water affects the survival of the grasshoppers.									
29b	The grasshoppers in set-up B had no <u>food</u>								
29c	Living things <u>reproduce</u>								

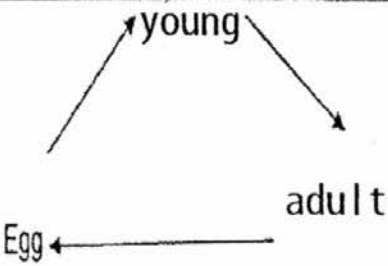
30a	
30b	Both have a <u>3 - staged</u> life cycle.
30c	When <u>some eggs</u> are eaten by predators, some eggs can still <u>hatch survive</u>
31a	The flowers will develop into <u>fruits</u> .
31b	Part A is used to <u>make</u> <u>food</u> for the plant.
31c	Part B helps to <u>hold</u> the plant <u>firmly</u> to the ground.
31d	The <u>greater</u> the number of Part B, the <u>greater</u> the amount of water absorbed by the plant.

32a	Part B. There are <u>no</u> <u>digestive</u> <u>juices</u> in Part B.
32b	<p>Part C only <u>continues</u> the digestion of food but Part D <u>completes</u> the digestion of food.</p> <p style="text-align: center;"><u>OR</u></p> <p>Part C does not <u>absorb</u> <u>digested</u> <u>food</u> into the bloodstream but Part D absorbs digested food into the <u>blood stream</u>.</p>
32c	The teeth <u>chew</u> food into <u>small</u> <u>pieces</u>
32d	<p>(i) <u>large intestine</u></p> <p>(ii) <u>stomach</u></p>
33a	He should use glass. It allows <u>most</u> light to pass through.
33b	The supports must be <u>strong</u> to support the weight of the tank.

34a

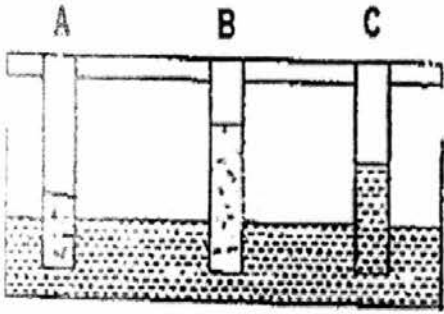

34b Material B.

Material B absorbs the most amount of water.

35a P has more volume than Q.

35b P has less mass than Q.

35c

Statement	Put a tick (✓) if the statement is true.
A heavier object has more mass than a lighter object.	✓
A bigger object definitely has more mass than a smaller object.	

36a	<table border="1"> <thead> <tr> <th>Steps to find out volume of rock</th> <th>Order</th> </tr> </thead> <tbody> <tr> <td>[Place the measuring cylinder under the spout to contain the water flowing out from the spout.</td> <td>2</td> </tr> <tr> <td>Fill the displacement can with water until it starts to flow out from the spout.</td> <td>1</td> </tr> <tr> <td>Place your eye at the water level in the measuring cylinder to find the volume of the rock.</td> <td>4</td> </tr> <tr> <td>Tie the rock to a string and lower it into the displacement can.</td> <td>3</td> </tr> </tbody> </table>	Steps to find out volume of rock	Order	[Place the measuring cylinder under the spout to contain the water flowing out from the spout.	2	Fill the displacement can with water until it starts to flow out from the spout.	1	Place your eye at the water level in the measuring cylinder to find the volume of the rock.	4	Tie the rock to a string and lower it into the displacement can.	3
	Steps to find out volume of rock	Order									
	[Place the measuring cylinder under the spout to contain the water flowing out from the spout.	2									
	Fill the displacement can with water until it starts to flow out from the spout.	1									
	Place your eye at the water level in the measuring cylinder to find the volume of the rock.	4									
Tie the rock to a string and lower it into the displacement can.	3										
36b	Matter has <u>volume</u> .										
37a	Pillow X has <u>air</u> in it which can <u>compress</u> when someone sleeps on it but Pillow Y is wood which is <u>stiff</u> .										
37b	Water has no <u>definite shape</u> .										
38a	80c										
38b	10 th to 15 th minute										

38c	Some amount of heat because the temperature of the milo is the same.
39a	<p>Variable changed: type of material</p> <p>Variable measured: amount of light that passed through</p>
39b	The thicker the material, the less light can pass through the material.
39c	<p style="text-align: center;">B → A → D → C</p>
39d	<p>Choice: C</p> <p>Data: The amount light that passed through was zero</p> <p>Concept: C is does not allow any light to pass through</p> <p>Application: Toilet door should not allow anyone to see through</p>
40a	<p>Set up Q.</p> <p>The clear plastic is ^{transparent} but the cardboard is <u>opaque</u>.</p>
40b	<p>When light is <u>blocked</u> by an object</p> <p style="text-align: right;">40c) Move object nearer to the screen. Move object further from the torch.</p>

Q 41 (b)

The diagram below shows the top view of the corridor that Jane is walking along. A mirror has been drawn into the diagram. Draw in light rays to show the direction that light will travel such that Jane can see that Mary is walking towards her from the school hall and be more careful. [2]

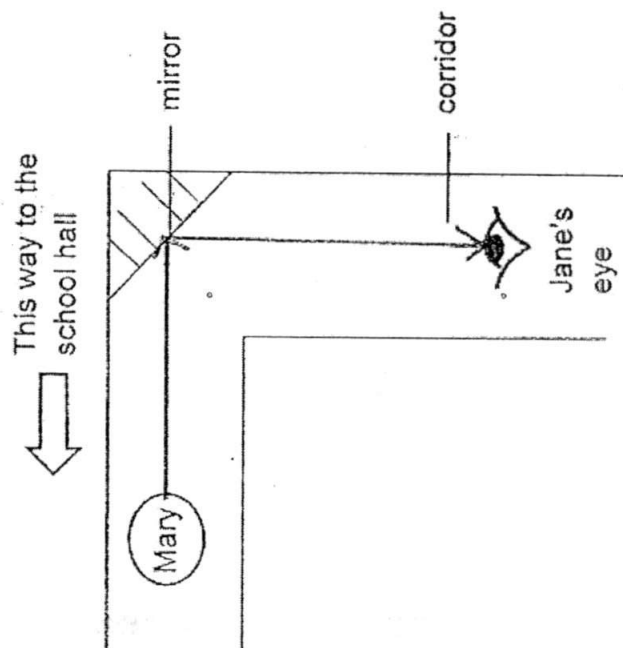

41)a)light travels in a straight line.

c)The light bulbs give out heat.