

# TAO NAN SCHOOL

## PRIMARY 4 SCIENCE YEAR-END EXAMINATION - 2009

Name : \_\_\_\_\_ ( )

Date : 29 October 2009

Class : P4 \_\_\_\_\_

Time : 8.00a.m. to ~~9.45 a.m.~~  
9.15a.m.

Booklet A

### INSTRUCTIONS TO CANDIDATES

Do not open this booklet until you are told to do so.

Follow all instructions carefully.

Answer all questions.

	Score	Marks
Section A		60
Section B		40
Total		100

Parent's signature : \_\_\_\_\_

**Section A (30 x 2 marks)**

For each question, 1 to 30, four options are given. One of them is the correct answer. Shade the correct oval (1, 2, 3 or 4) on the Optical Answer Sheet.

1. A beaker has a certain amount of water as shown in Figure A. Figure B shows the same beaker of water when object Z is placed in it.

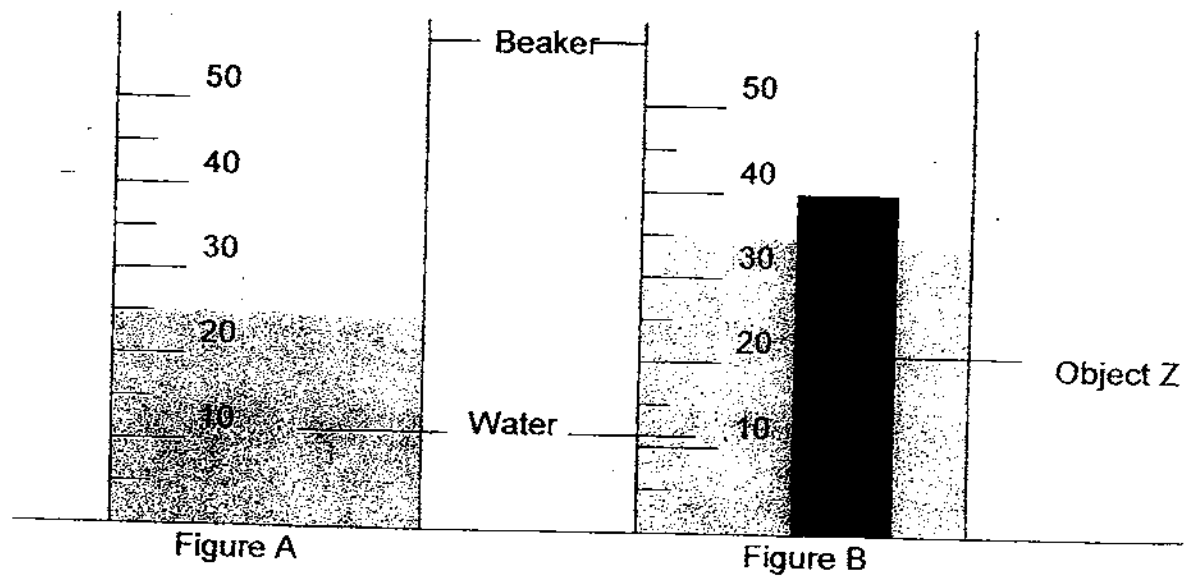

What is the likely volume of Object Z?

- (1)  $10 \text{ cm}^3$
- (2)  $35 \text{ cm}^3$
- (3) Between  $10 \text{ cm}^3$  and  $20 \text{ cm}^3$
- (4) Between  $25 \text{ cm}^3$  and  $35 \text{ cm}^3$

2. Rachel took out an empty glass bottle from the refrigerator. She immediately filled it up with some hot water. She observed that the glass bottle cracked soon after the hot water was poured into it. Which of the following best explains her observation?

- (1) The bottle lost heat.
- (2) The bottle gained heat.
- (3) The bottle did not expand evenly.
- (4) The bottle did not contract evenly.

3. The diagram below shows the digestive system in a human body.

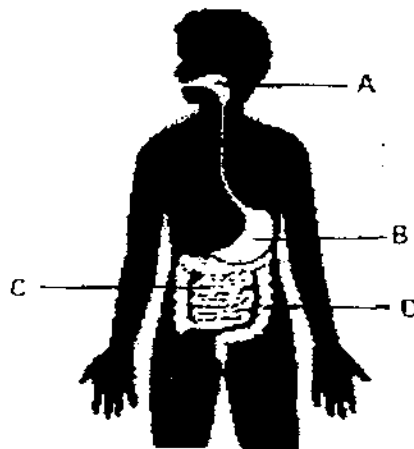

Which of the following correctly describes the processes of digestion at A, B, C and D ?

	A	B	C	D
(1)	Saliva mixes with the food in the mouth	Digestive juices soften the food	Food is moved into D to be absorbed into the bloodstream	Digested food is absorbed into the bloodstream
(2)	Digestion begins with the help of saliva	Food is broken down into simpler substances	Digestion ends with food being absorbed into the bloodstream	Water and some mineral salts are absorbed
(3)	Saliva is produced to soften the food	Digested food is absorbed into the bloodstream	Food is further broken down into simpler substances	Waste materials are passed out of the body
(4)	Chewed food is swallowed	Food is mixed with the blood	Food is moved into D to be absorbed into the bloodstream	Digested food is absorbed into the body

4. Mrs Ho wanted to find out what type of soil is suitable for growing balsam plants. She planted balsam plants of similar size in three pots, X, Y and Z. The three pots of plants were placed in the same part of the garden with the conditions shown below.

	X	Y	Z
Material of pot	Plastic	Plastic	Plastic
Type of soil	Garden soil	Sandy soil	Clayey soil
Amount of soil	1500 cm <sup>3</sup>	900 cm <sup>3</sup>	600 cm <sup>3</sup>
Amount of water given every day	100 ml	100 ml	100 ml

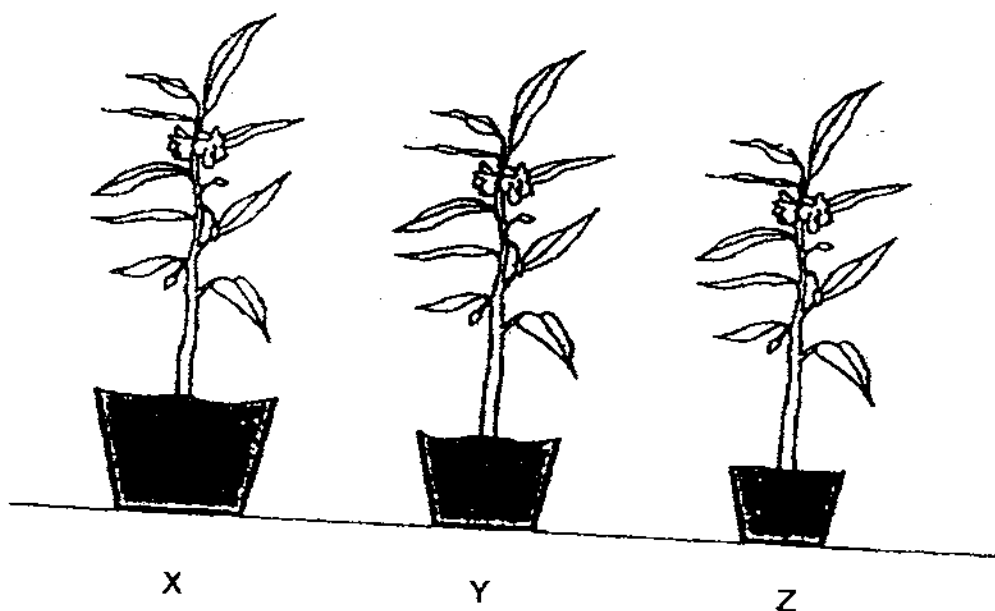

Why was the experiment **NOT** a fair one?

- A The amount of soil in each pot was different.
  - B The type of soil used in each pot was different.
  - C The three pots were given the same amount of water.
  - D The size of the pots were of different sizes.
- (1) A and B only  
 (2) A and D only  
 (3) B and C only  
 (4) C and D only

5. Some water containing red dye was poured into the soil of a potted plant. After three days, some parts of the flowers and leaves turned red. Which of the following explain the observation?

- (1) Food from the leaves is transported to the flowers.
- (2) Water from the roots is transported to all parts of the plant.
- (3) Water and mineral salts are taken in by the roots.
- (4) There are tubes that carry water and food in the stem.

6. Siew Teng set up an experiment as shown below.

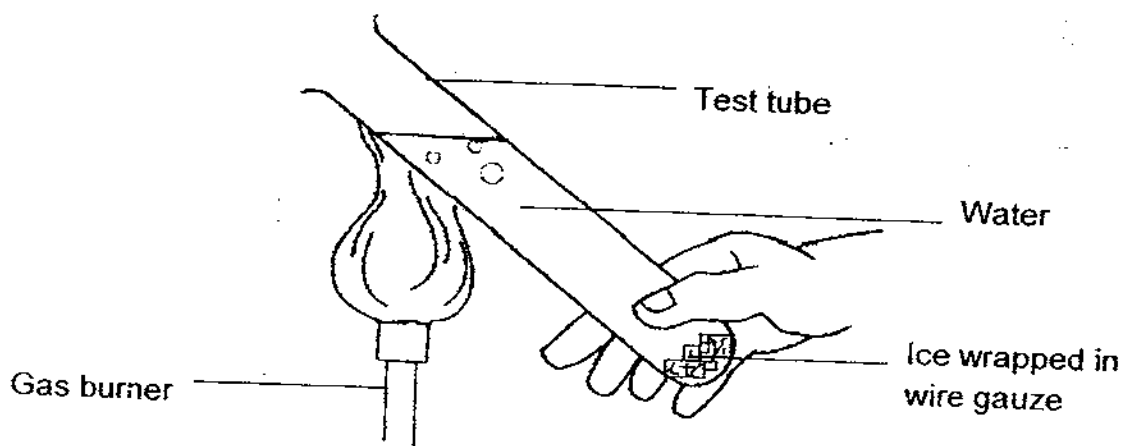

When the water near the top of the test-tube started boiling, the ice in it still did not melt. What did the experiment show?

- (1) The melting point of ice is higher than the boiling point of water.
- (2) Water is a poor conductor of heat so little heat travels to the ice.
- (3) Hot air rises so most heat travels to the boiling water but not the ice.
- (4) The wire gauze is a good conductor of heat and prevents the ice from melting.

7. The chart below shows some objects classified based on certain property of their materials.

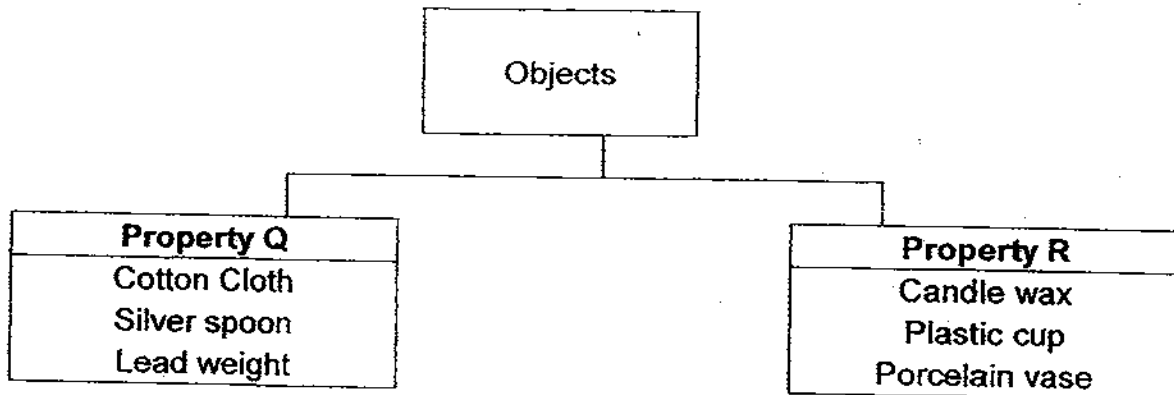

Which of the following are the properties represented by Property Q and Property R?

	Property Q	Property R
(1)	Metals	Non-metals
(2)	Natural materials	Man-made materials
(3)	Magnetic materials	Non-magnetic materials
(4)	Do not allow light to pass through	Allow light to pass through

8. Air is trapped inside three plastic bags, A, B and C.



A



B

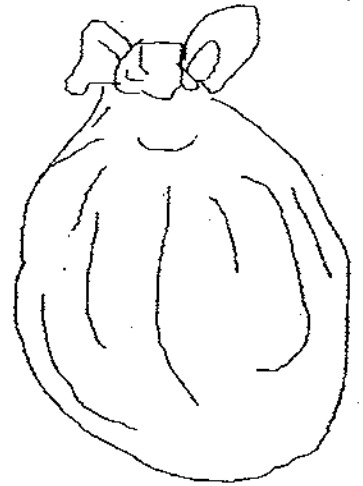

C

Which of the following about the bags of air is definitely true?

- (1) The air in C is the most compressed.
- (2) The air in the three bags has definite shape.
- (3) The mass of air in B is bigger than that in A and smaller than that in C.
- (4) The volume of air in B is bigger than that in A and smaller than that in C.

9. James did an experiment using two similar plants which were placed in two containers of different sizes. He was trying to find out if the size of the container would affect the growth of the plant.

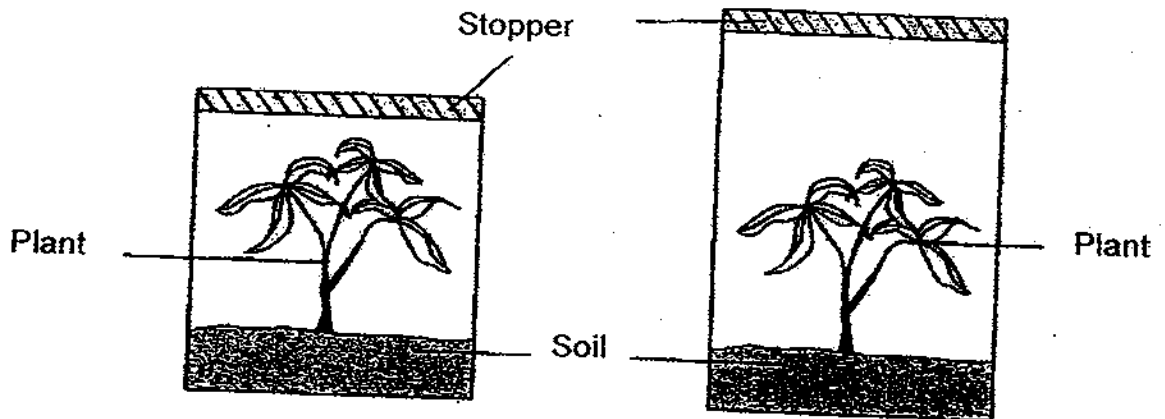

Which of the following will ensure that it is a fair test?

- (1) The stoppers are made of glass.
- (2) The plants are given tap water everyday.
- (3) The only changed variable is the size of container.
- (4) The container must be made of the same material.



10. Two rectangular panels, P and Q, were placed between two torches and a screen. The screen shows what was observed when the torches were switched on.

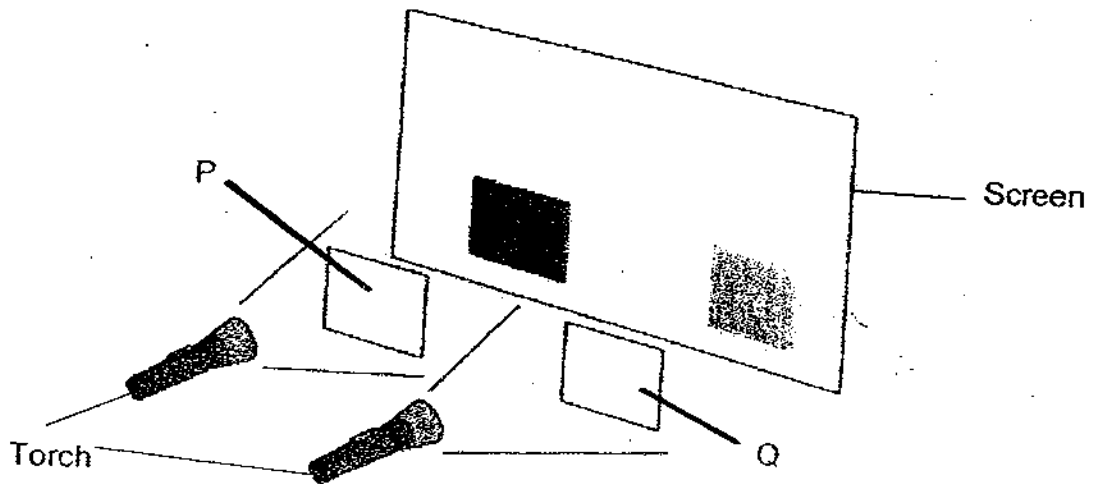

Which of the following is **correct**?

- (1) P is black and Q is grey.
  - (2) P is opaque while Q is translucent.
  - (3) P reflects light but Q does not reflect light.
  - (4) P is made of wood and Q is made of frosted glass.
11. Which of the following is **true**?
- (1) A shadow has mass and occupies space.
  - (2) A shadow is formed when light is blocked.
  - (3) When light is reflected, a shadow is formed.
  - (4) The colour of a shadow depends on the colour of the object.

12. Affifah shines a torch on a wooden pole as shown in the diagram below. She shifts the torch to a position where there was almost no shadow when the torch is shone at the wooden pole.

Where does she shift the torch?

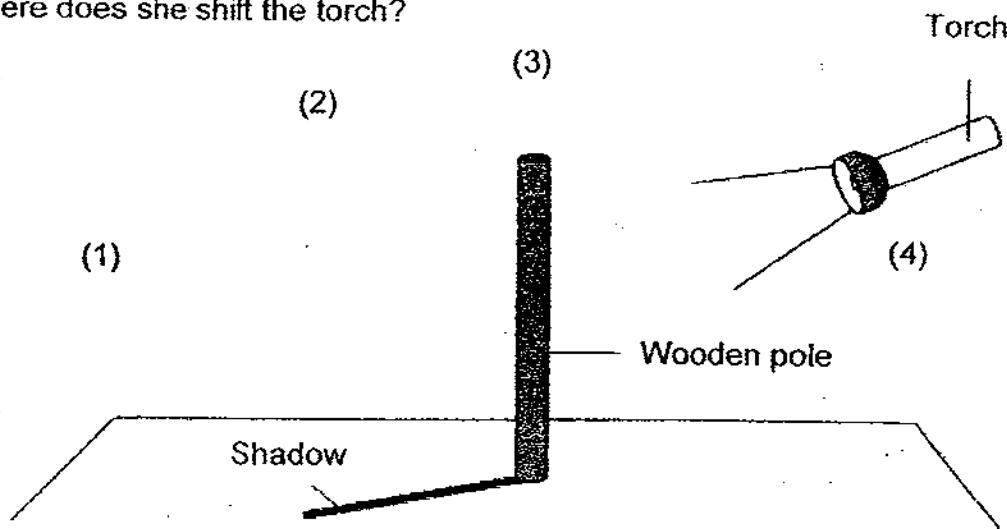

13. Study the set-ups, X and Y below.

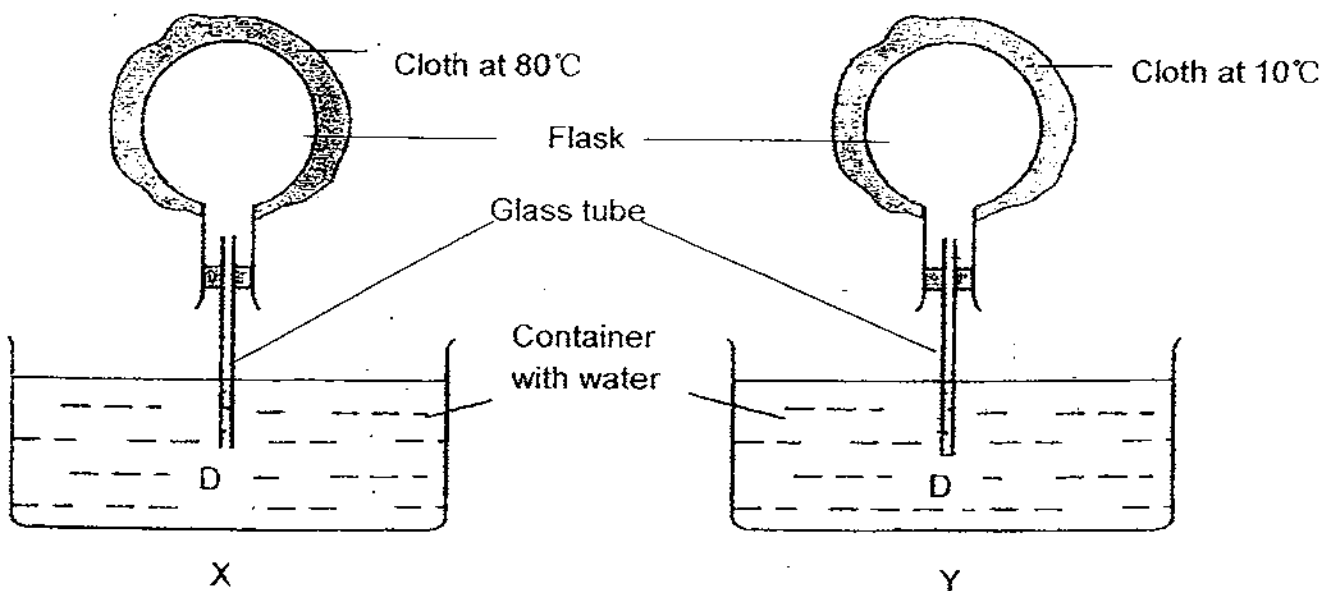

Which of the following is not an observation of the set-ups two minutes after the cloth was placed on the flask?

- (1) In X, water level in the glass tube falls.
- (2) In Y, water level in the glass tube rises.
- (3) In X, bubbles escape from the glass tube at D.
- (4) In Y, bubbles escape from the glass tube at D.

14. Arrange the following in the correct order to describe breathing.

- A Air goes into the windpipe.
- B Air enters the nose.
- C Hairs in the nose trap dust and dirt present in the air.
- D Lung expands when air from the windpipe enters.

- (1) A → B → C → D
- (2) B → C → D → A
- (3) B → C → A → D
- (4) C → D → A → B

15. A cup of hot water at 80°C is placed in a basin of water at room temperature.

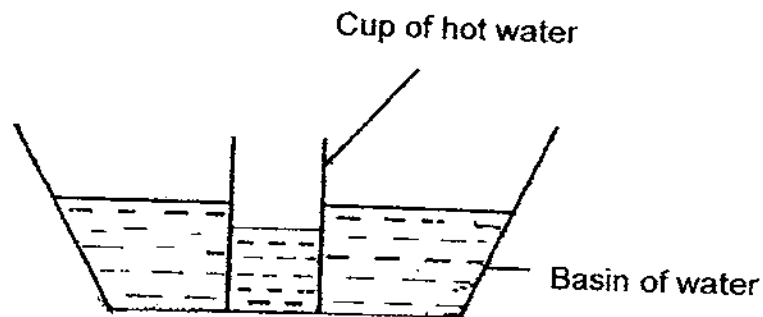

After a while, the water in the cup and basin have the same temperature. Which of the following are the explanations?

- A The water in the basin lost heat to the hot water in the cup.
- B The water in the basin gained heat from the hot water in the cup.
- C The hot water in the cup gained heat from the water in the basin.
- D The hot water in the cup lost heat to the water in the basin.

- (1) A and C only
- (2) A and D only
- (3) B and D only
- (4) C and D only

16. Displacement Can A displaces water when the volume of water exceeds 80ml. Displacement Can B displaces water when the volume of water exceeds 30ml. 200 ml of water is poured into Displacement can A as shown below. What is the volume of water in the beaker in the end?

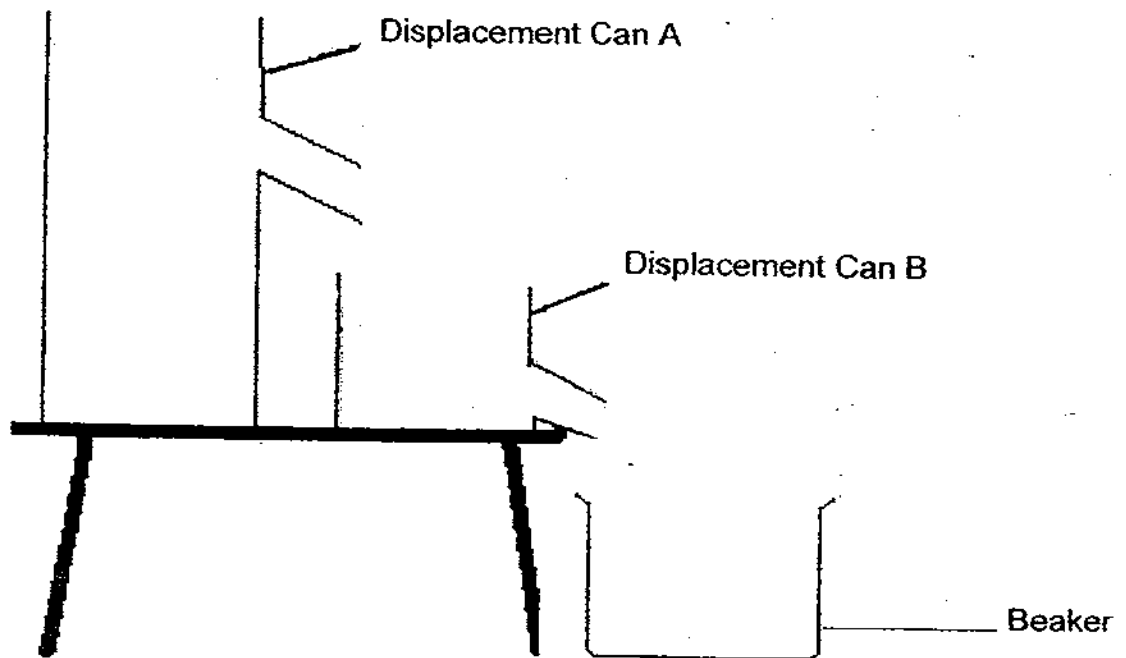

- (1) 50 ml  
 (2) 90 ml  
 (3) 120 ml  
 (4) 170 ml
17. At 6 a.m. in ~~the morning~~, Henry goes to his car and notices that the outer surface of his car windscreen is misty. Which of the following best describes what happened?
- (1) Water vapour condensed on the cooler car windscreen, forming water droplets.  
 (2) Steam condensed on the cooler car windscreen, forming water droplets.  
 (3) Water evaporated from the warmer car windscreen, forming water vapour.  
 (4) Ice melted on the warmer car windscreen, forming water.

18. Samantha placed an iron figurine on a steel sheet and held a magnet under the sheet. A magnet attracts iron but the iron figurine did not move when the magnet was moved as shown in the diagram below. Which of the following is **definitely true**?

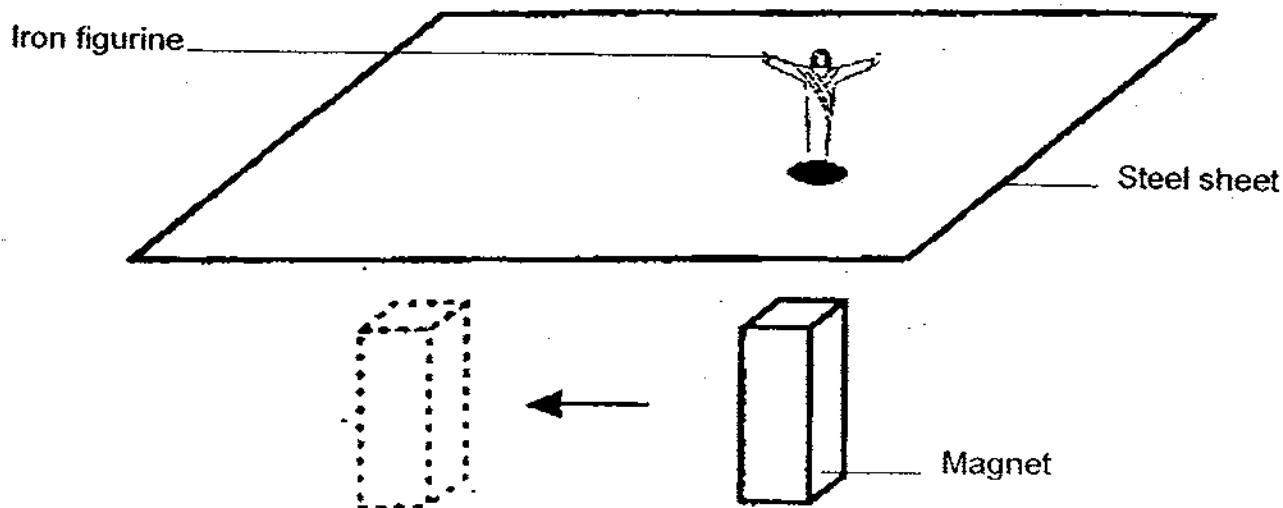

- (1) The steel sheet prevented the magnet from attracting the iron figurine.
  - (2) The iron figurine was too heavy to be attracted by the magnet.
  - (3) The magnet was too weak to attract the iron figurine.
  - (4) The iron figurine was too far from the magnet to be attracted by it.
19. Which of the following are functions of a skeleton?
- A It supports the body.
  - B It gives the body shape.
  - C It protects important organs inside the body from injury.
  - D It allows muscles to attach themselves to enable the body to move.
- (1) D only
  - (2) C and D only
  - (3) B, C and D only
  - (4) A, B, C and D

20. Jane used a torch to create a shadow on a screen using an opaque object as shown below.

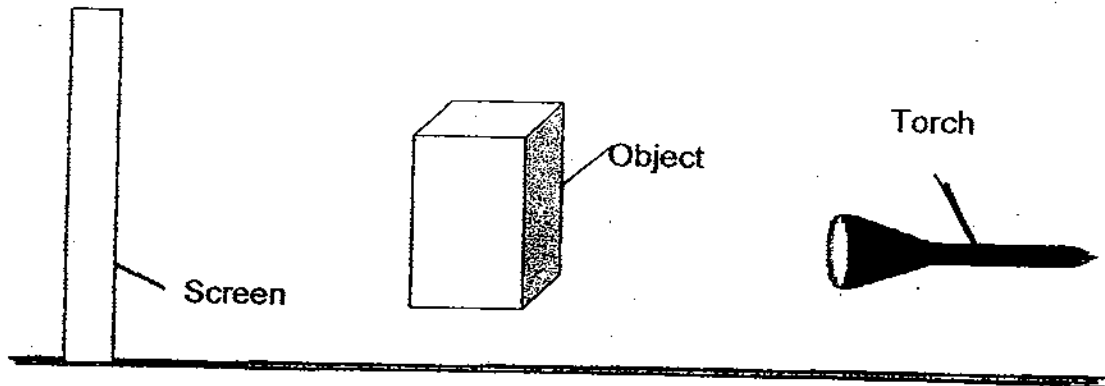

If she wants to obtain a **bigger** shadow, what must she do?

- (1) Move the screen nearer to the object.
- (2) Move the torch further from the object.
- (3) Move the object and torch nearer to the screen.
- (4) Move the object and torch further from the screen.

21. The diagram below shows a U-shaped glass tube containing some water.

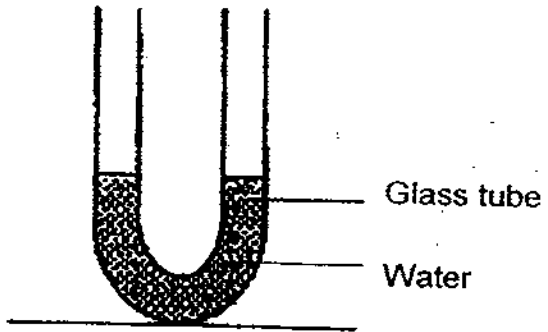

Which of the following diagrams shows how the water in the glass tube would look like when the glass tube is tilted?

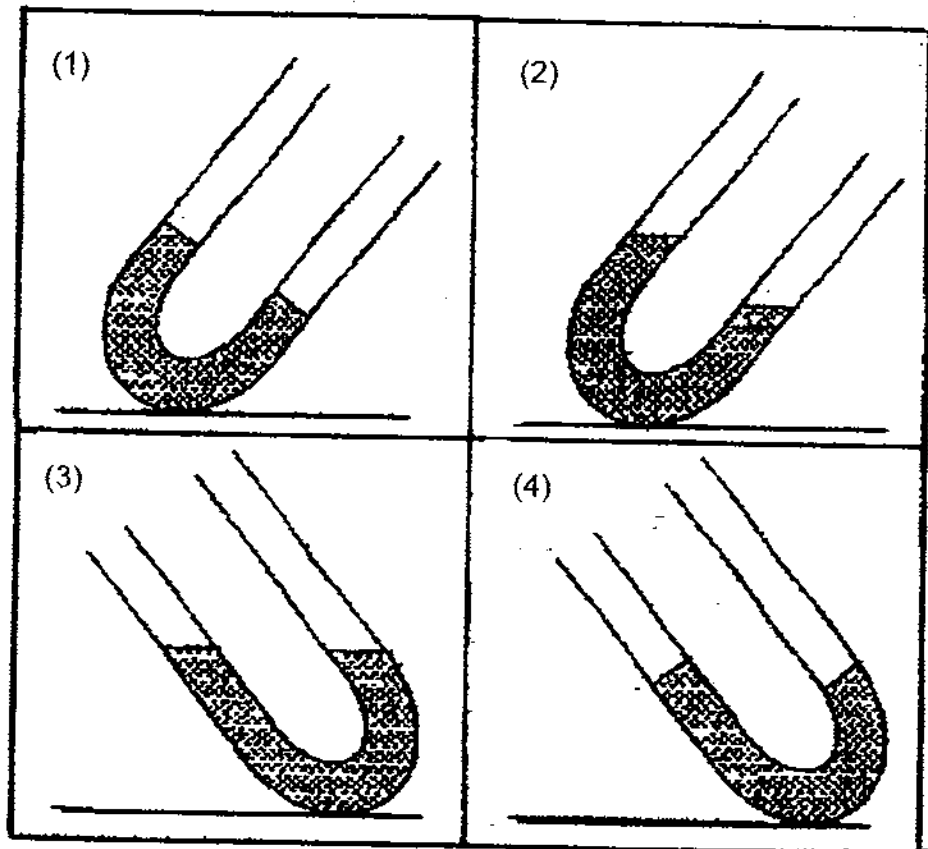

22. An experiment was carried out to find out the effect of different weights on a spring. After the experiment, a line graph was plotted as shown below.

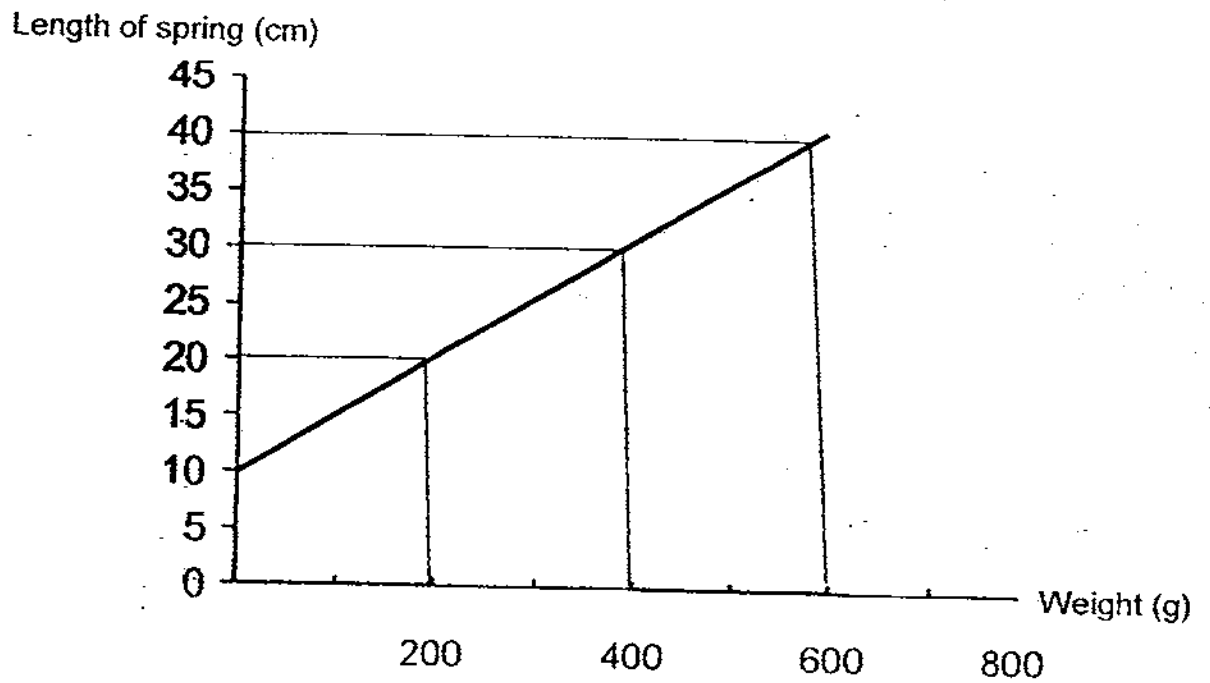

What can we conclude about the experiment from the line graph?

- A The length of the spring is 10 cm.
- B The length of the spring doubles when the weight doubles.
- C The length of the spring is 50 cm when a 800 g weight is hung on it.
- D The length of the spring increases as the weight increases.

- (1) B only
- (2) C and D only
- (3) A, C and D only
- (4) A, B, C and D



23. Some pupils were given four plants and a classification chart as shown below.

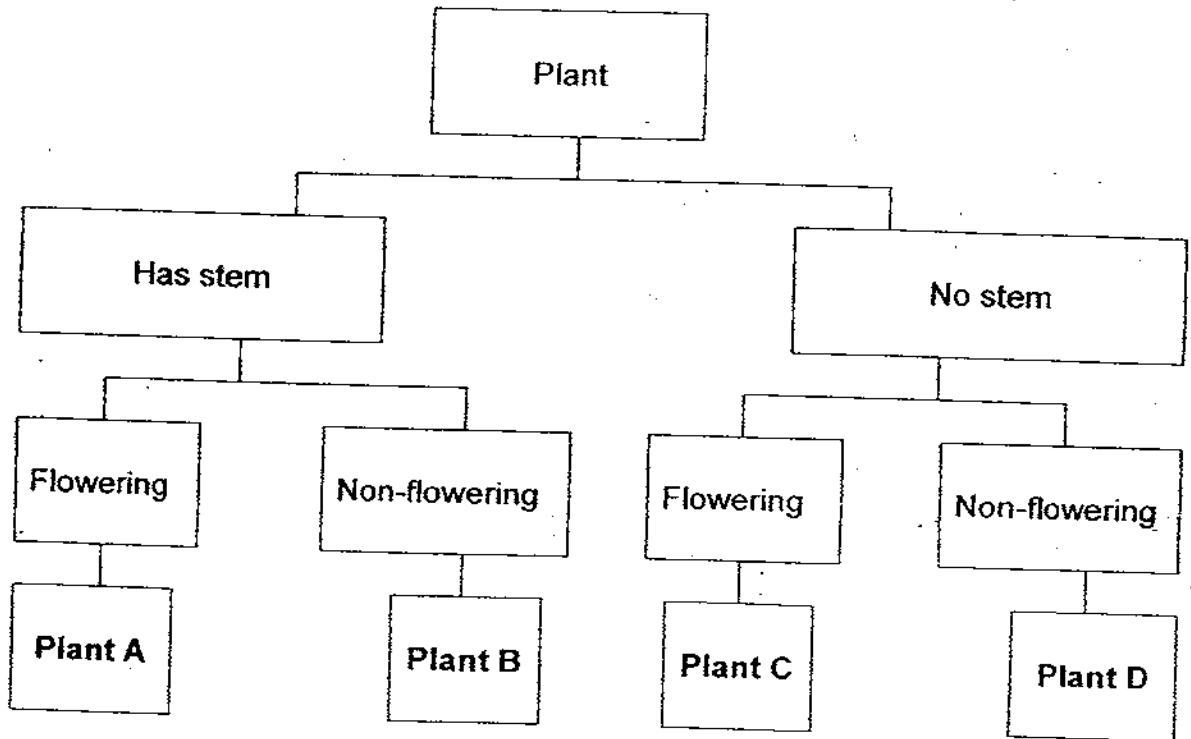

The pupils identified the plants in the chart. Which of the following shows the plants in the chart?

	Plant A	Plant B	Plant C	Plant D
(1)	Duckweed	Algae	Money plant	Bird Nest's fern
(2)	Bird Nest's fern	Duckweed	Algae	Money plant
(3)	Money plant	Bird Nest's fern	Duckweed	Algae
(4)	Algae	Money plant	Bird Nest's fern	Duckweed

24. Mary set up the experiment below. She put 2 identical pieces of toasted bread, A and B, into a transparent bag each and placed them in a dark cupboard.

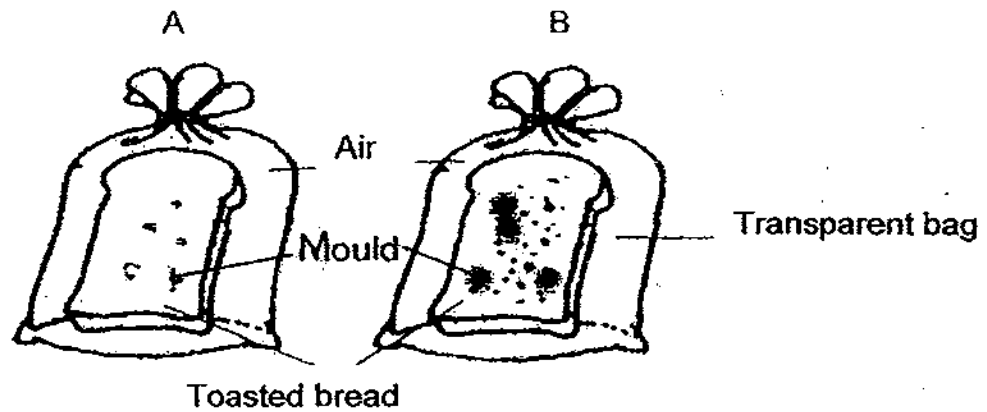

She added a few drops of water to B but not A. Five days later, she observed that B had more mould than A. Based on the experiment, which of the following is **correct**?

- (1) Mould needs sunlight to grow.
- (2) Mould needs oxygen to survive.
- (3) Yeast in the bread causes the mould to grow.
- (4) Mould grows faster on bread with more moisture.

25. The diagram below shows W, X, Y and Z, the four stages in the life cycle of a butterfly and when fertilisation occurs.

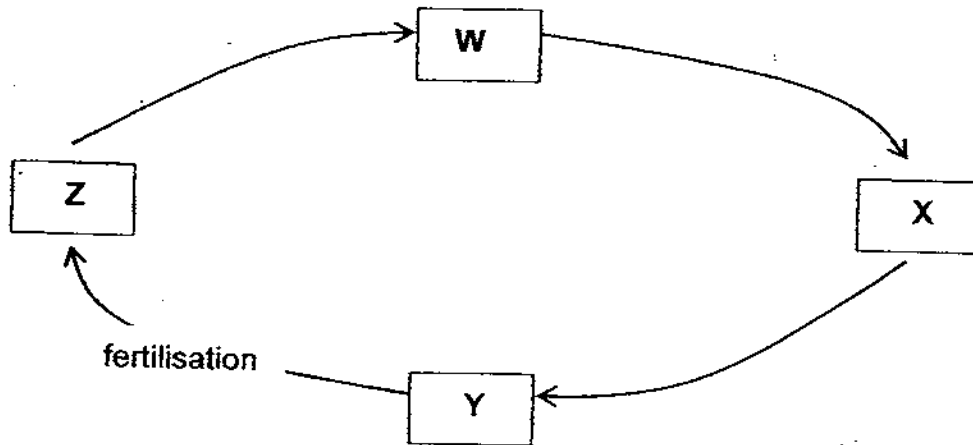

Which of the following represents W, X, Y and Z respectively?

	W	X	Y	Z
(1)	Egg	Larva	Pupa	Adult
(2)	Larva	Pupa	Adult	Egg
(3)	Pupa	Adult	Egg	Larva
(4)	Adult	Egg	Larva	Pupa

26. Pauline dipped the ends of four magnets, P, Q, R and S, into a pile of staples.

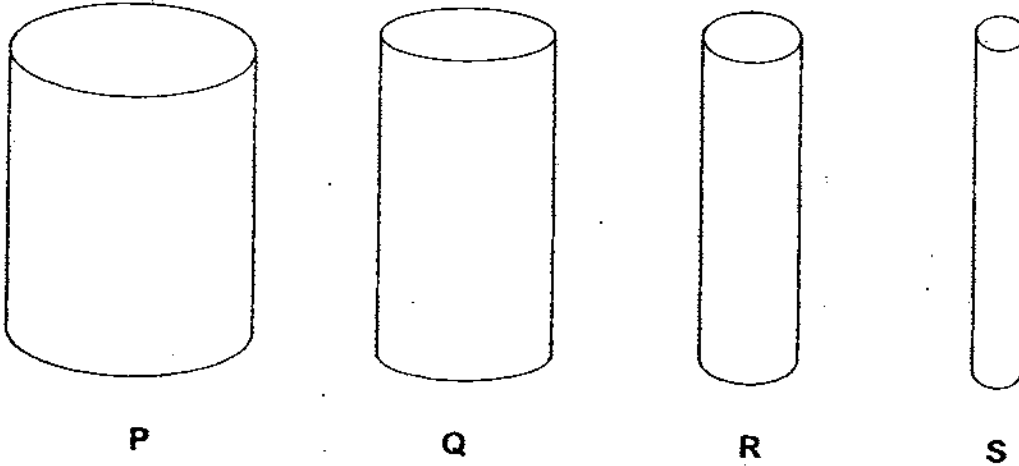

Then she counted the number of staples picked up by the end of each magnet. She recorded the results in the table below.

Magnet	Number of staples picked by the magnet
P	16
Q	18
R	20
S	14

Which of the following is correct?

- (1) The thicker the magnet, the stronger its magnetic force.
- (2) The thinner the magnet, the weaker its magnetic force.
- (3) The strength of a magnet depends on its width.
- (4) The strength of a magnet does not depend on its width.

27. The diagram below shows the top view of a tunnel.

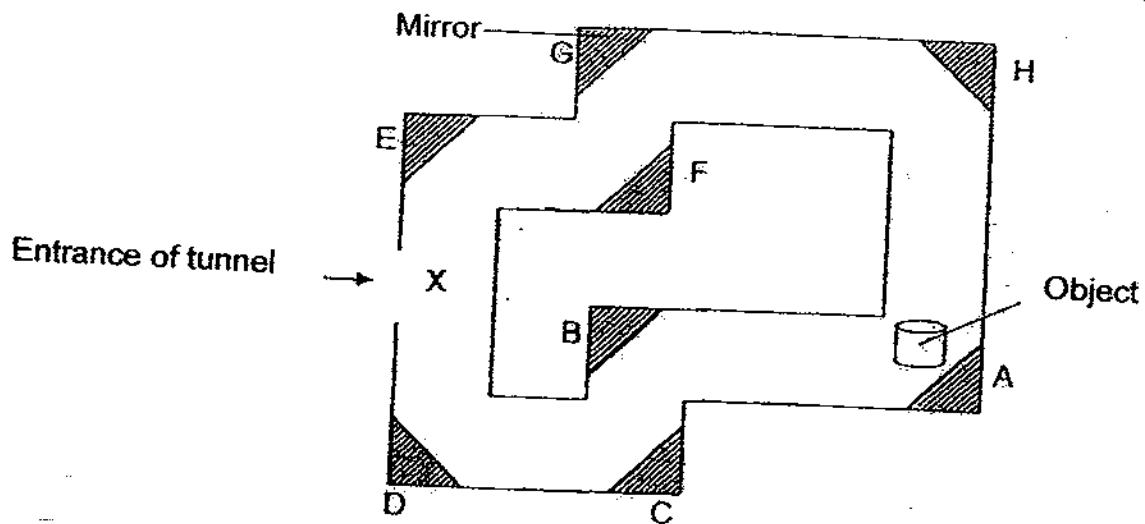

Ken is standing at point X. Using the least number of mirrors, which are the mirrors he needs to see the object?

- (1) B, C and D only
- (2) A, B, C and D only
- (3) E, F, G and H only
- (4) A, E, F, G and H only

28. Which of the following diagrams shows the path taken by a ray of light when it falls on a mirror?

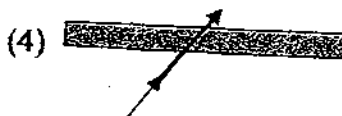

29. James classified 6 items into two groups, X and Y.

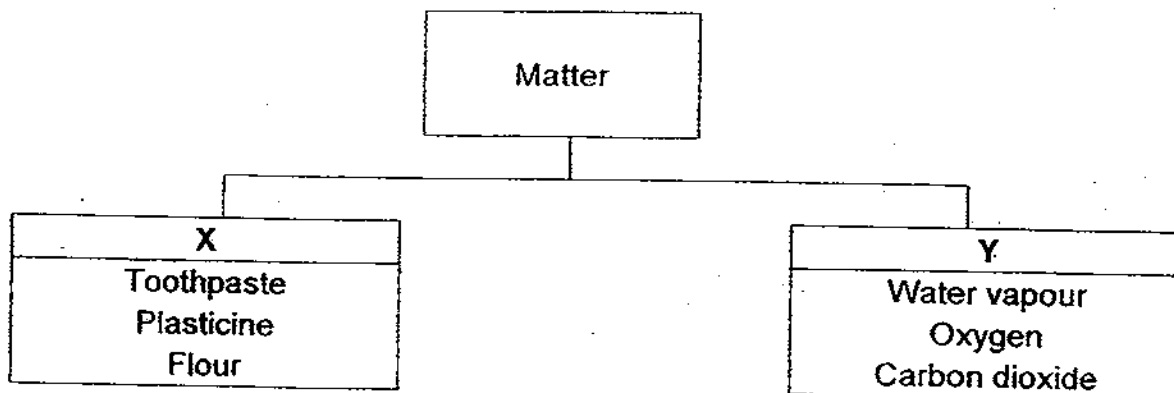

What are the properties of the matter in the groups, X and Y?

	X	Y
(1)	Occupies space	Does not occupies space
(2)	Definite volume	Indefinite volume
(3)	Can be compressed	Cannot be compressed
(4)	Has mass	No mass

30. Study the classification table below.

Group A	Group B	Group C	Group D
Turkey Crow Eagle	Goat Cow Leopard	Python Lizard Crocodile	Crab Lobster Snail

What characteristic has been used to classify the animals above?

- (1) The place they live
- (2) Their outer body covering
- (3) Their food
- (4) The way they move

# TAO NAN SCHOOL

## PRIMARY 4 SCIENCE YEAR-END EXAMINATION – 2009

Name : \_\_\_\_\_ (     ) Date : 29 October 2009

Class : P4 \_\_\_\_\_

**Booklet B**

### INSTRUCTIONS TO CANDIDATES

Do not open this booklet until you are told to do so.

Follow all instructions carefully.

Answer all questions.

	Score	Marks
Section B		40

**Section B (40 marks)**

For each question, 31 to 46, write your answers in the spaces provided.

---

31. The picture below shows a bird.

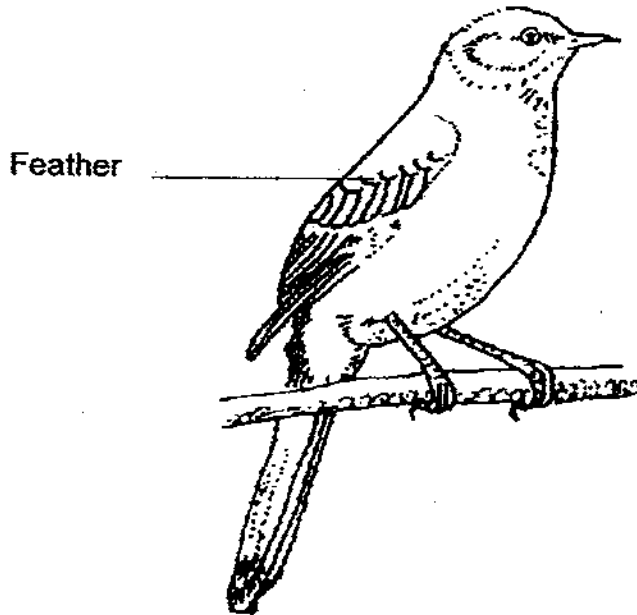

(a) Using its feathers, the bird can fly. Suggest two other uses of feathers.

(1m)

i) \_\_\_\_\_

ii) \_\_\_\_\_

(b) Based on the picture, state another characteristic of a bird.

(1m)

\_\_\_\_\_  
\_\_\_\_\_



32. The life cycle of a mosquito below is incomplete.

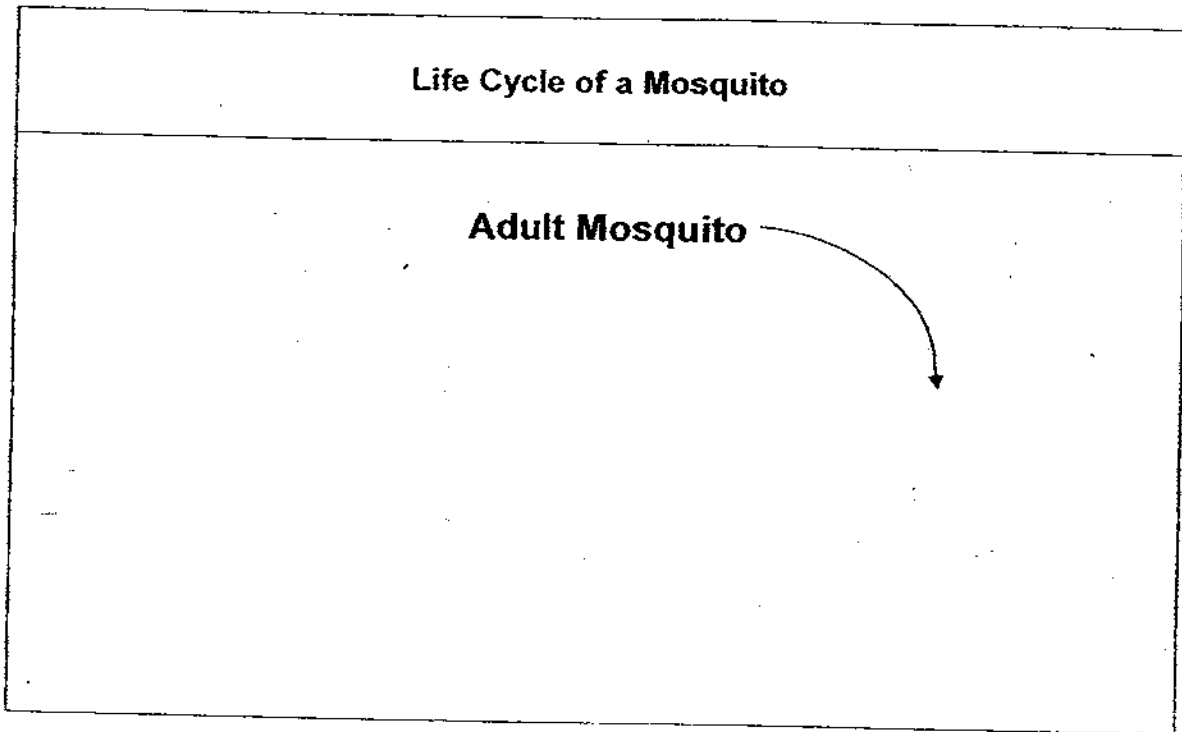

(a) Complete the life cycle of the mosquito. (1m)

(b) The adult stage in the life cycle of the mosquito is the most difficult to get of. Explain why? (1m)

---

---

33. Joshua and Michael plan to find out if the amount of sunlight will affect the growth of the plant. Fill in the boxes (i) and (ii) to ensure that the test is fair. (1m)

Name of pupil	Type of plant	Soil	Water	Location
Joshua	Green bean	Garden soil	300 ml	In a garden
Michael	i)	Garden soil	ii)	In a dark cupboard

- (b) Michael's plant did not grow as healthy as Joshua's plant. Explain why. (1m)

---

---

34. The same volume of boiling water was poured into two identical containers of the same size, shape and colour. The containers were placed in a room with temperature of 30°C. The water in Container R took 25 minutes to cool down to room temperature. The water in Container S took 40 minutes to cool down to room temperature.

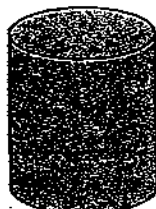

Container R



Container S

- (a) Suggest one reason why the containers took different lengths of time to cool down to room temperature. (1m)

---

---

- (b) Kevin bought some tea. He cooled down the tea by pouring the tea from one glass to another.



How did that enable the tea to cool down?

(1m)

---

---

35. Classify the following into three groups based on the organ systems they belong to. (3m)

lungs	blood vessels	gullet
skull	small intestine	heart
ribs	stomach	windpipe

<b>Circulatory System</b>	<b>Respiratory System</b>	<b>Skeletal System</b>

36. The table below shows some aquatic plants found in a pond.

<b>Submerged plants</b>	<b>Group B</b>	<b>Partially-submerged plants</b>
Cabomba	Water Lettuce	Cattail
Elodea	Water Hyacinth	Arrowhead
Hydrilla	Duckweed	Sedge

(a) Give a suitable heading for the plants in Group B. (1m)

(b) If Group B grows uncontrolled in the pond, which group of plants would be most affected? Explain why. (1m)

37. The diagram below shows the processes that cause changes in the state of water.

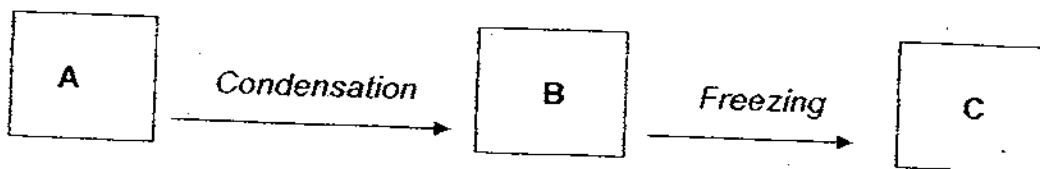

Identify the **state** of the water.

- (a) A is the \_\_\_\_\_ state. (1m)
- (b) B is the \_\_\_\_\_ state. (1m)
- (c) C is the \_\_\_\_\_ state. (1m)

38. Tom drew the diagram below to show how he can see the books in his room. The arrows represent the light rays.

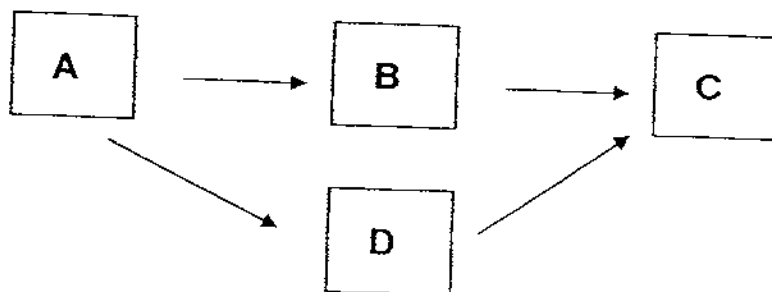

- (a) The observer is represented by \_\_\_\_\_ (1m)
- (b) The only light source is represented by \_\_\_\_\_ (1m)
- (c) List two natural light sources. (1m)
  - i) \_\_\_\_\_
  - ii) \_\_\_\_\_

39. Mabel wanted to find the volume of water absorbed by the roots of a plant. She placed two identical plants in Pot A and Pot B respectively. Same volume of water was poured into the two pots. A layer of oil was added to Pot A.

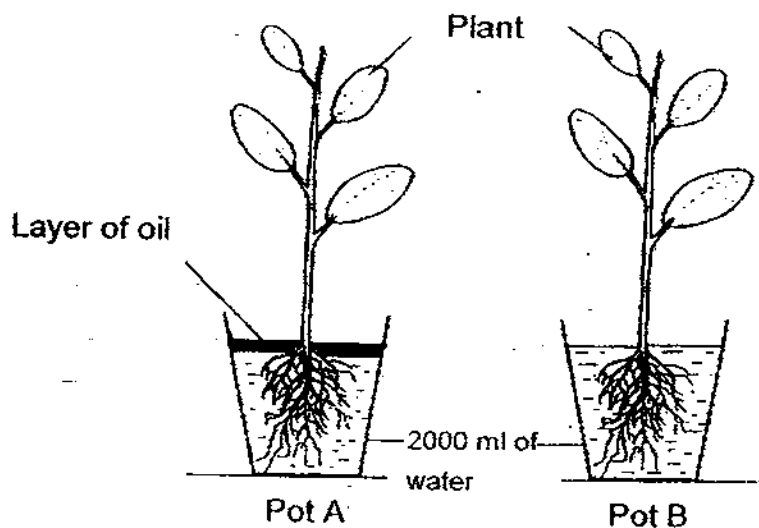

The two set-ups were left in the open for three days. Mabel measured the volume of water in the two pots on Day 1 and Day 3.

- (a) Assist her by matching the volumes of **1500ml** and **1700ml** to the correct pots by filling in the table below. (1m)

Pot	Volume of water (ml)	
	Day 1	Day 3
Pot A	2000	i)
Pot B	2000	ii)

- (b) Explain why there was a difference in the volume of water left in Pot A and Pot B at the end of Day 3. (1m)

---



---

40. Rachel classified some items into three groups, P, Q and R, as shown in the table below.

P	Q	R
Tracing paper	Aluminium can	Spectacle lenses
Yellow cellophane	Cardboard	Glass bulb
Frosted glass	Mirror	Clear plastic

(a) The arrows shown in the diagram below indicate the amount of light that can pass through the items in the three groups. Complete the diagram with P, Q and R.

(1m)

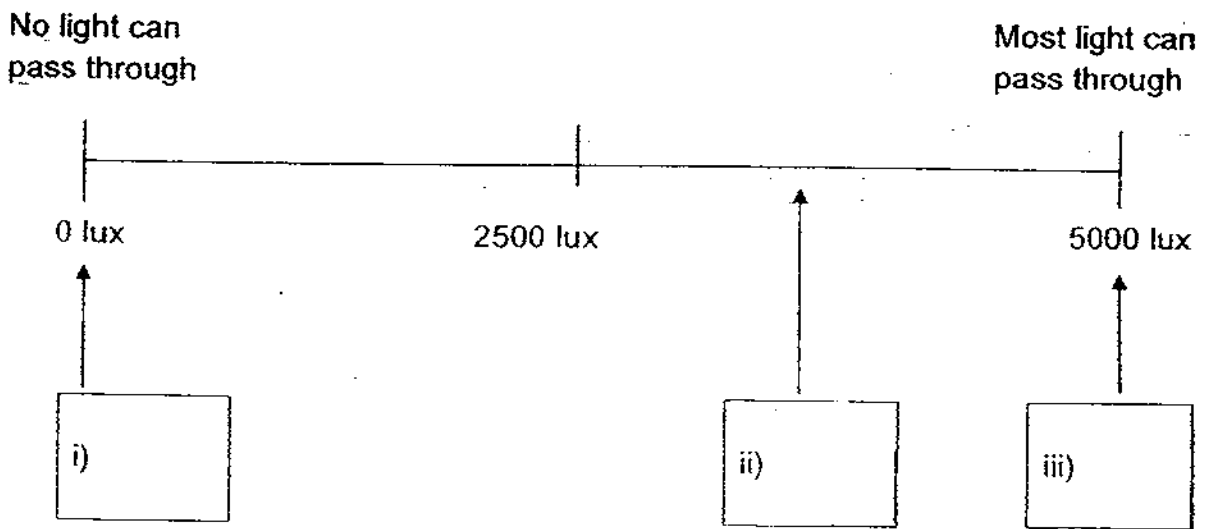

(b) All the items are re-classified in the table below. Identify the characteristic used to re-classify all the items.

(2m)

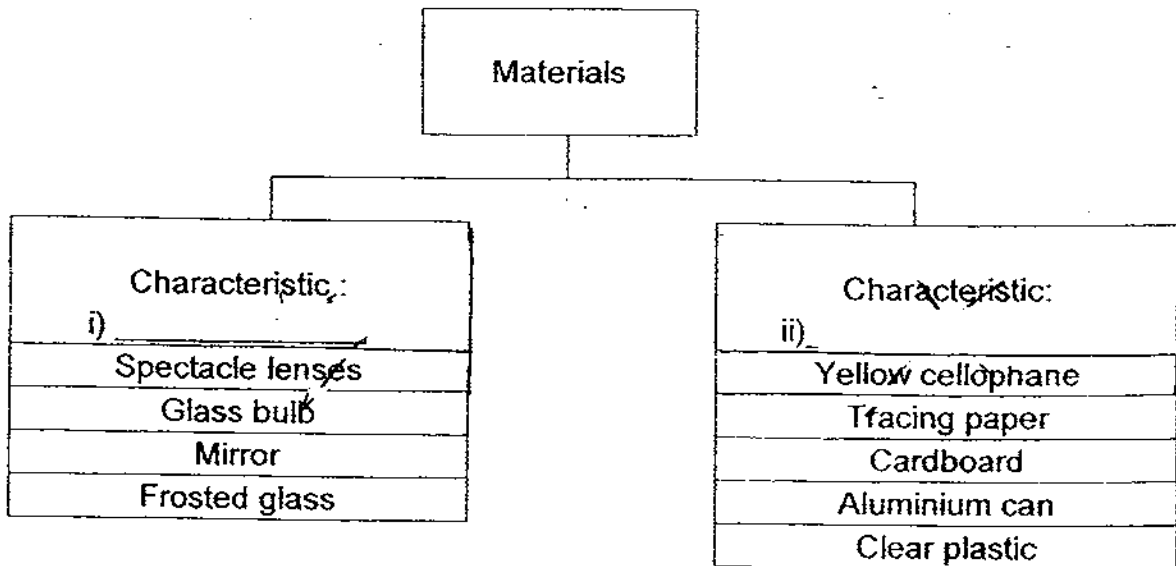

41. Melody took a few ice cubes from a freezer and instantly heat them in a beaker over a gas stove. After a while, she stopped the heating and let the beaker cool down to room temperature.

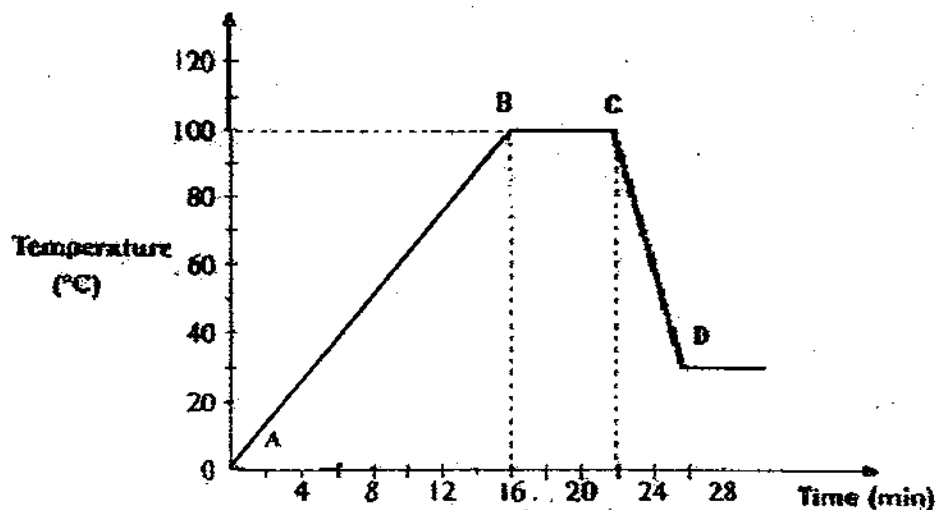

- (a) Name the process that is taking place along BC. (1m)

---

- (b) At which point, A, B, C or D, was the ice cube taken out of the freezer? (1m)

---

- (c) How long did Melody heat the ice cube before the temperature reach 100°C? (1m)

---



4242. Ravi studied the three examples of matter, J, K and L, and recorded his findings in the table below.

Property	J	K	L
Is it a liquid?	No	No	No
Is it magnetic?	No	Yes	No
Is it opaque?	No	Yes	Yes
Is it a good conductor of heat?	No	Yes	No

What about the three examples of matter, J, K and L, do not fit the three examples of matter that fit the property stated in the table above (3 (3) m)

J	K	L
Mercury	Iron	Steel
Air	Elastic	Wood
Aluminium	Glass	Card

43. Four identical fish made of different materials were placed in a basin of tap water for an hour as shown below. When they were taken out of the water, their weights were measured again.

Basin of tap water

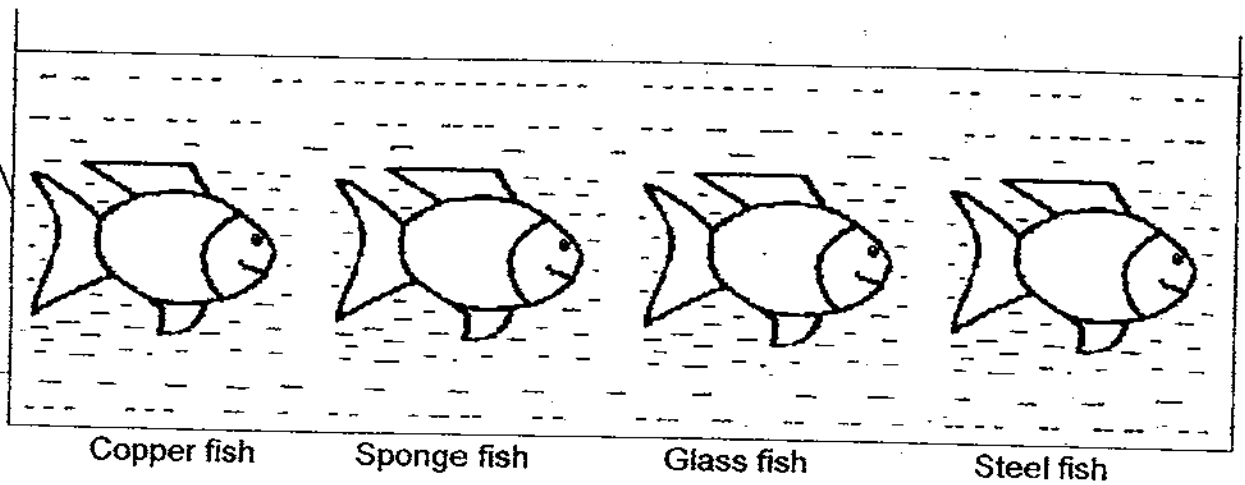

- (a) Which of the above fish would show the greatest **increase** in weight? (1m)

---

- (b) Explain your answer in (a). (1m)

---

- (c) Which of the fish would float on the water **at first**? (1m)

---

44. Valerie wants to compare the conductivity of heat among three different materials, plastic, wood and copper. He puts a dab of margarine on the ends of each of three rods, plastic rod, wooden rod and copper rod. He sticks a green bean onto each dab of margarine. He also pours an equal volume of water of hot water into the three beakers as shown in the diagram below.

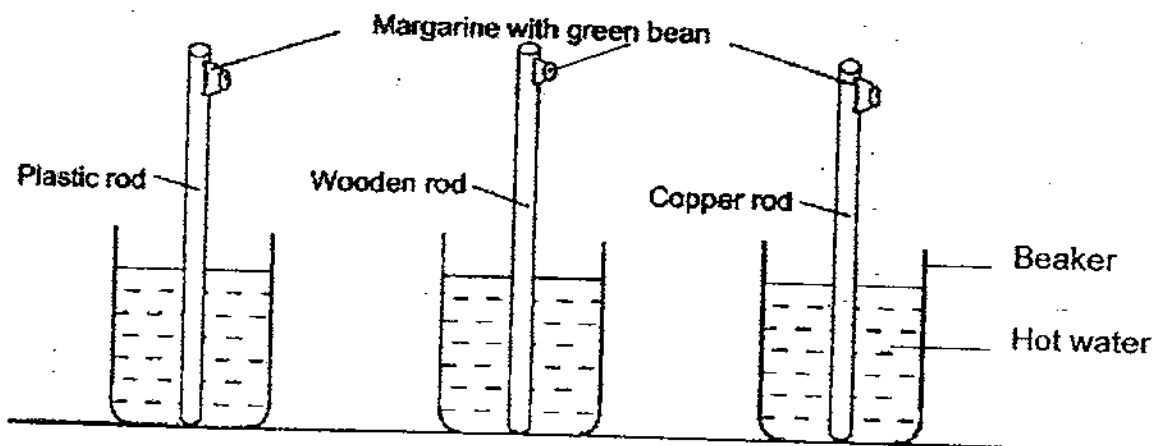

Tick (✓) the correct boxes.

(3m)

	Statement	True	False	Not possible to tell
(a)	If the bean on the copper rod slides down first, copper is the best conductor of heat.			
(b)	The only changed variable is the material of the rods.			
(c)	Valerie should use cold water instead.			

45. The diagram below shows the changes in the state of water as heat is gained or lost. Complete the diagram with "heat gained" or "heat lost". (2m)

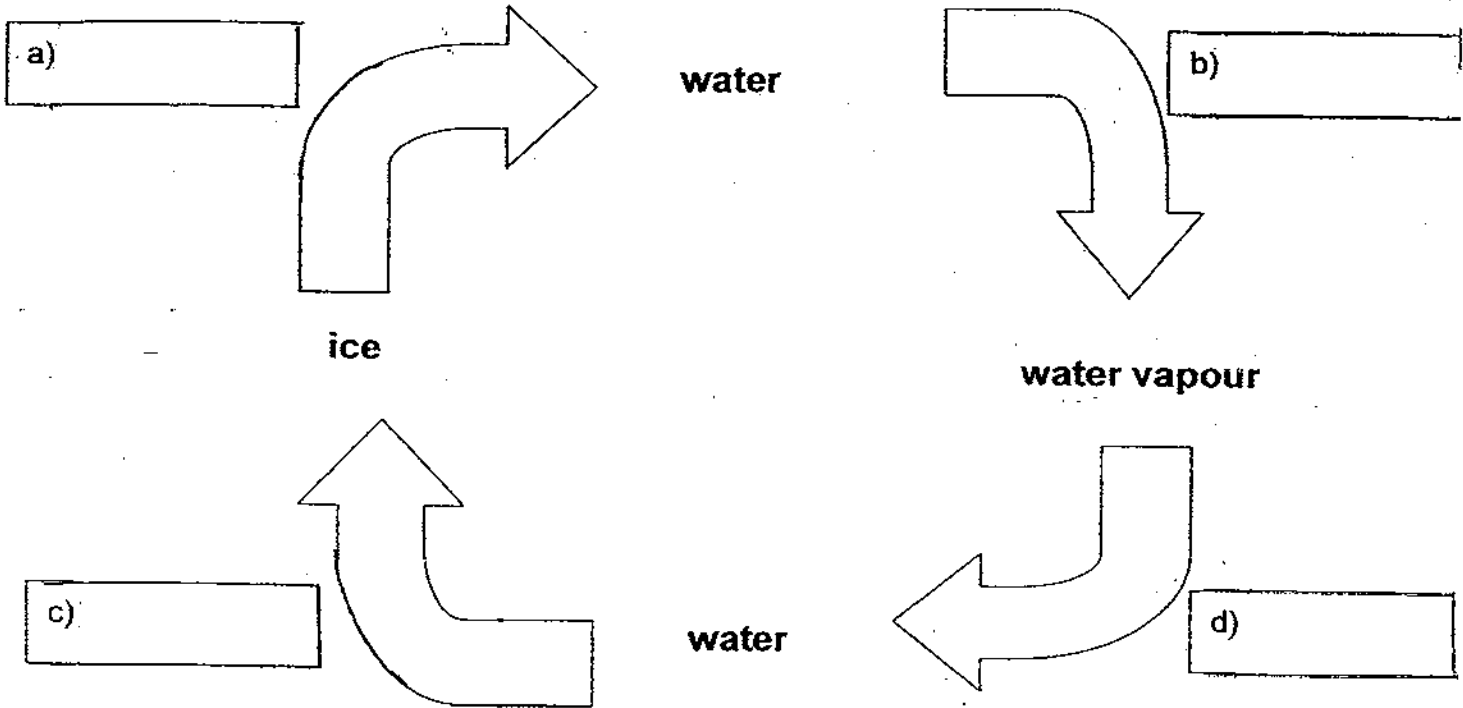

46. The picture below shows an electro-magnet. It is able to attract five paper clips.

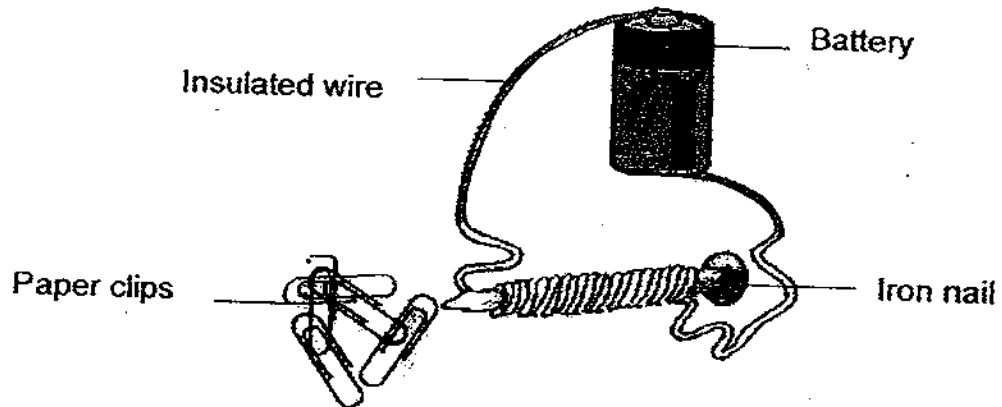

- (a) To attract more paper clips to the iron nail, what should you do? (1m)

---

---

- (b) Name another method to magnetise the iron nail. (1m)

---



# ANSWER SHEET

## EXAM PAPER 2009

SCHOOL : TAO NAN PRIMARY  
SUBJECT : PRIMARY 4 SCIENCE

TERM : SA2

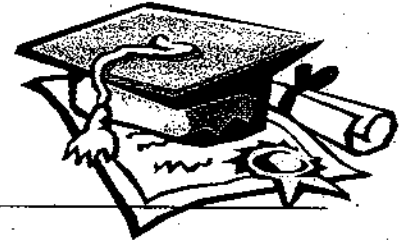

Q1	Q2	Q3	Q4	Q5	Q6	Q7	Q8	Q9	Q10	Q11	Q12	Q13	Q14	Q15	Q16	Q17
3	3	2	2	2	2	2	4	3	2	2	3	4	3	3	2	1

Q18	Q19	Q20	Q21	Q22	Q23	Q24	Q25	Q26	Q27	Q28	Q29	Q30
1	4	4	3	3	3	4	3	4	1	2	2	2

- 31)a)i)It can protect the bird.  
ii)It would keep the bird warm.  
b)It has a pair of wings.

32)a)

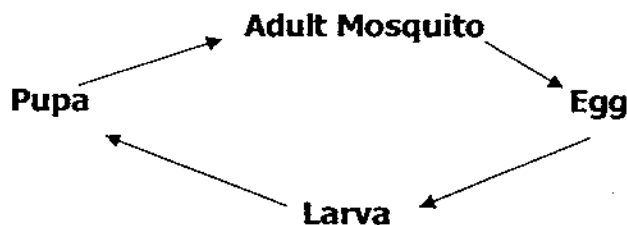

b)It can fly.

- 33)a)i)Green bean    ii)300ml  
b)Michael's plant did not have sunlight.

- 34)a)They are made of different material.  
b)There is larger exposed surface area of water to lose heat to the surrounding air.

35)blood vessels  
Heart

windpipe  
lungs

skull  
ribs

36)a)Floating plants.

b)Submerged plants. The floating plants will block them from reaching to the sunlight.

37)a)Gaseous      b)Liquid      c)Solid

38)a)C      b)A      c)i)Sun      ii)Star

39)a)i)1700ml      b)1500ml

b)In pot A, the layer of oil prevented loss of water by evaporation and only the roots of the plant could absorb the water. However in pot B, some water is lost by evaporation and the roots of the plant could absorb the water too.

40)a)i)Q      ii)P      iii)R  
b)i)break easily      ii)do not break easily

41)a)Boiling.  
b)point A.  
c)16min.

42)42)Air      iron      wood

43)a)Sponge fish.  
b)The sponge fish could absorb water but the others are waterproof.  
c)Sponge fish.

44)a)T      b)T      c)F

45)a)heat gained      b)heat gained      c)heat lost      d)heat lost

46)a)T should put more batteries or coil more times.  
b)He can stroke the iron nail.