

SINGAPORE CHINESE GIRLS' SCHOOL (PRIMARY)

SECOND SEMESTRAL ASSESSMENT 2016

NAME: _____ ()

DATE: 21 October 2016

CLASS: PRIMARY 4 SY / C / G / SE / P

Parent's Signature: _____

SCIENCE
BOOKLET A

28 questions

56 marks

Total time for Booklets A & B: 1 h 45 min

DO NOT OPEN THIS BOOKLET UNTIL YOU ARE TOLD TO DO SO.

FOLLOW ALL INSTRUCTIONS CAREFULLY.

Part I (56 marks)

For each question from 1 to 28, four options are given. One of them is the correct answer. Make your choice (1, 2, 3 or 4). **Shade the correct oval (1, 2, 3 or 4) on the Optical Answer Sheet.**

1. A millipede will move when touched.



This shows that the millipede is a living thing because it can _____.

- 1) grow
- 2) breathe
- 3) respond
- 4) reproduce

2. Which one of the following objects is made of material that was once alive?

- 1) metal spoon
- 2) wrapping paper
- 3) ceramic cup
- 4) plastic pail



- 2) wrapping paper



- 4) plastic pail



3. Which animal has a pupal stage in its life cycle?

- 1) toad
- 2) duck
- 3) beetle
- 4) grasshopper

4. Which one of the following shows the correct order when food moves through some parts of the digestive system?

1)



2)

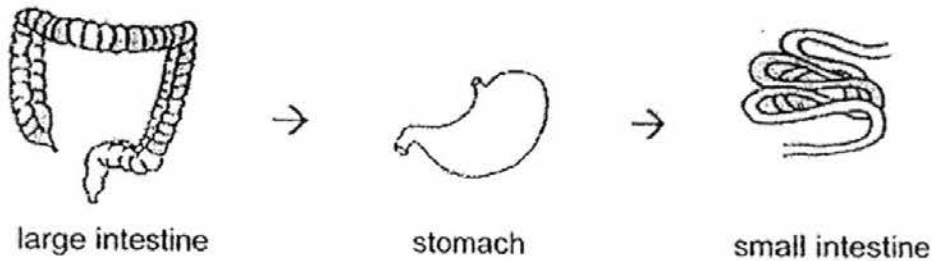

3)



4)



5. Study the diagram below.

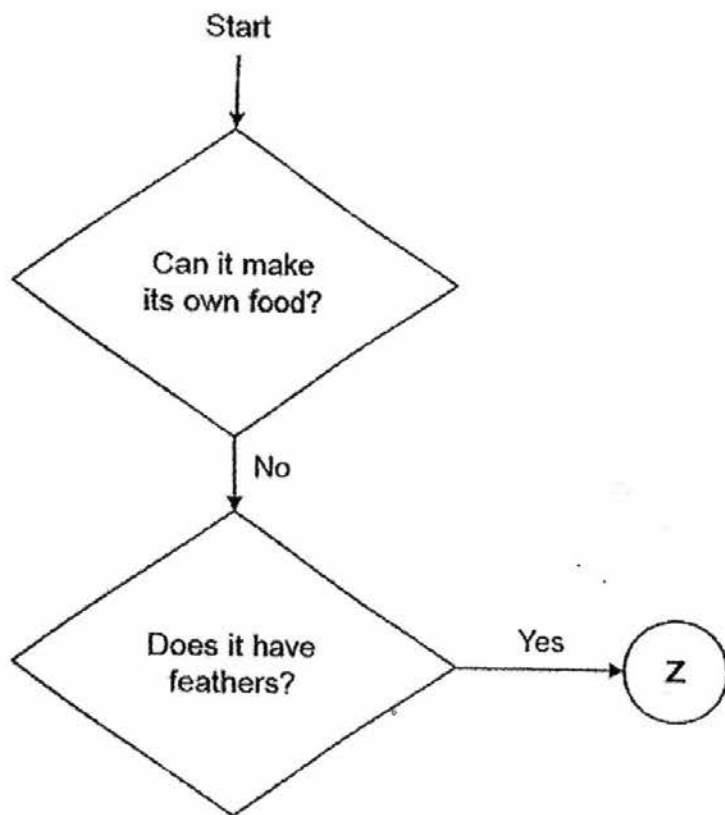

What could Z be?

- | | |
|----------|-----------|
| 1) bird | 3) insect |
| 2) plant | 4) mammal |

6. The diagram below shows the growth of a young plant with two missing stages P and Q.

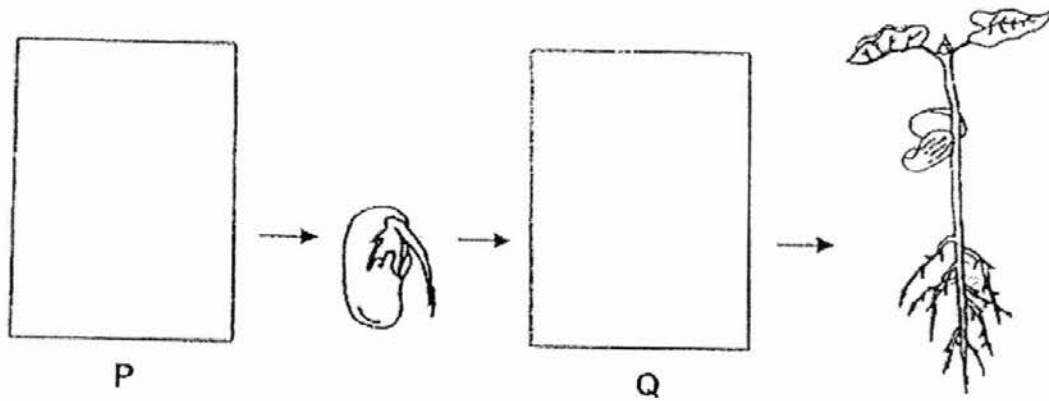

Which one of the following shows the correct stages for P and Q?

	P	Q
1)		
2)		
3)		
4)		

7. In the diagram, what is the volume of Liquid K?

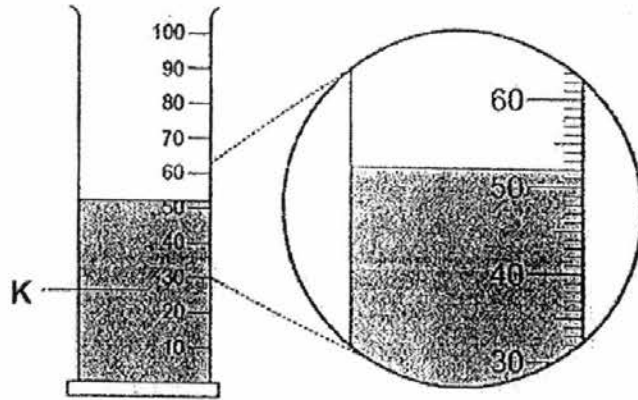

- 1) 50 ml
- 2) 52 ml

- 3) 62 ml
- 4) 68 ml

8. Which part, 1, 2, 3 or 4 makes food for the plant?

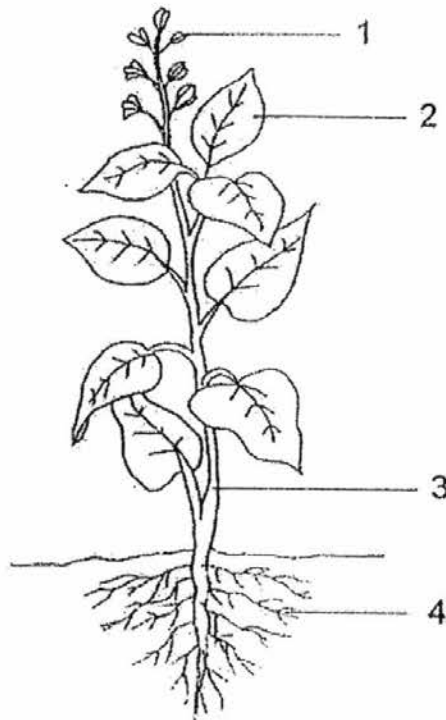

9. An object A was attracted to a magnet, as shown in the figure below.

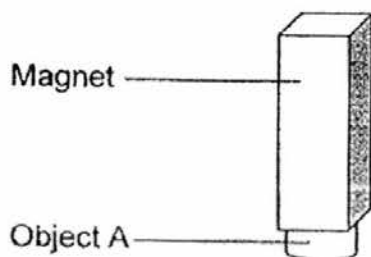

Object A is made of _____.

- 1) steel
- 2) wood
- 3) plastic
- 4) rubber

10. Which one of the following is the best conductor of heat?

- 1) A metal plate
- 2) A paper plate
- 3) A plastic plate
- 4) A wooden plate

11.

Group A	Group B	Group C
snake	horse	crow
guppy	polar bear	eagle
crocodile	spiny anteater	pigeon

The above animals are grouped according to their _____.

- 1) habitats
- 2) eating habits
- 3) body coverings
- 4) method of reproduction

12. The diagram below shows the life cycle of Animal X.

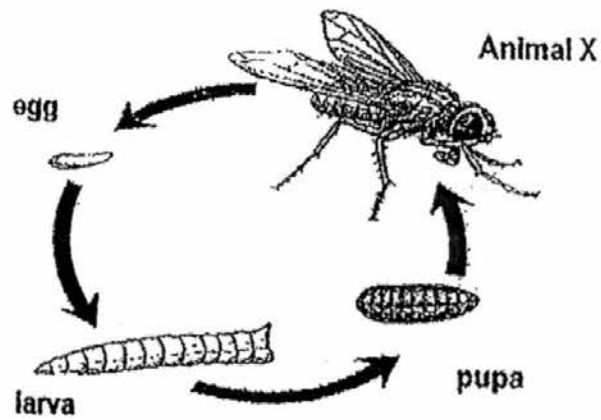

Which statements describe Animal X correctly?

- A) Its young looks like its adult.
- B) It has 4 stages in its life cycle.
- C) It gives birth to its young alive.
- D) Its young does not have wings.

- 1) A and B only
- 2) A and C only
- 3) B and D only
- 4) C and D only

13. Marion accidentally dented a ping pong ball as shown below.

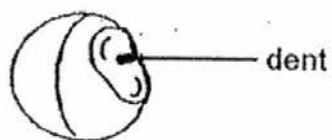

What conclusions can she draw from the above activity?

- A) Air can be compressed.
- B) Air has no definite volume.
- C) The ball has a definite shape.

- 1) A and B only
- 2) A and C only
- 3) B and C only
- 4) A, B and C

14. Ivan wanted to find out whether the exposed surface area of water affects the rate of evaporation of water. He filled three containers, A, B and C, with water and then left them near an open window.

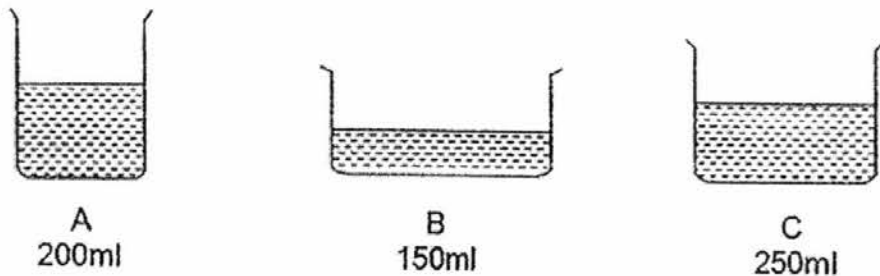

What should Ivan do to conduct a fair test for his aim?

- 1) Cover the containers.
 - 2) Use the same type of containers.
 - 3) Place the containers in different places.
 - 4) Use the same amounts of water in the containers.
15. Two identical potted plants, G and H, were left outside in the sun for a few days. The diagram below shows how the plants looked like at the end of the day. What was lacking in pot H but not in pot G?



- 1) air
- 2) water
- 3) warmth
- 4) sunlight

16. Look at the picture below.

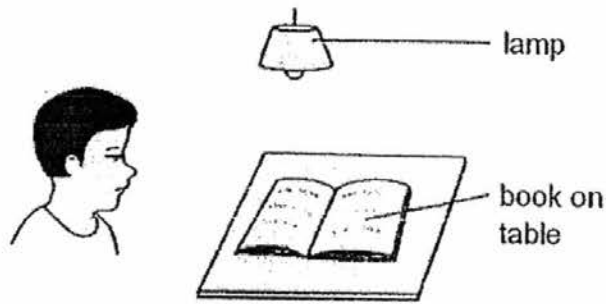

Which one of the following explains why Felix can see the book on the table?

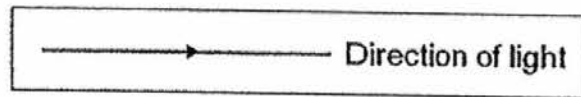

1)

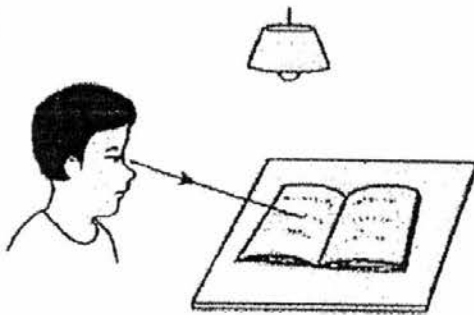

3)

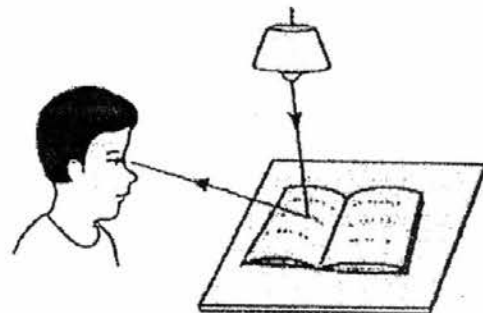

2)

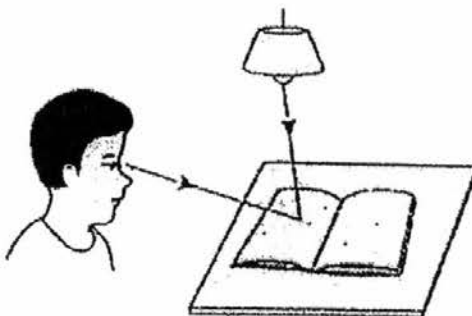

4)

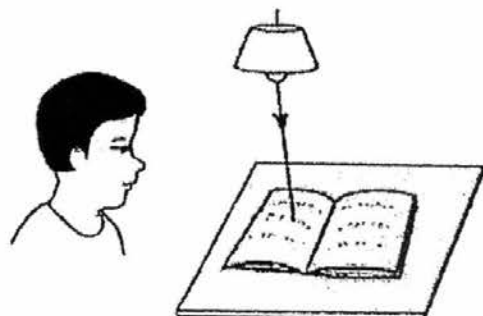

17. Jia En prepared three basins of water, X, Y and Z, at different temperatures for an experiment. She put her right hand into Basin X and her left hand into Basin Z as shown below.

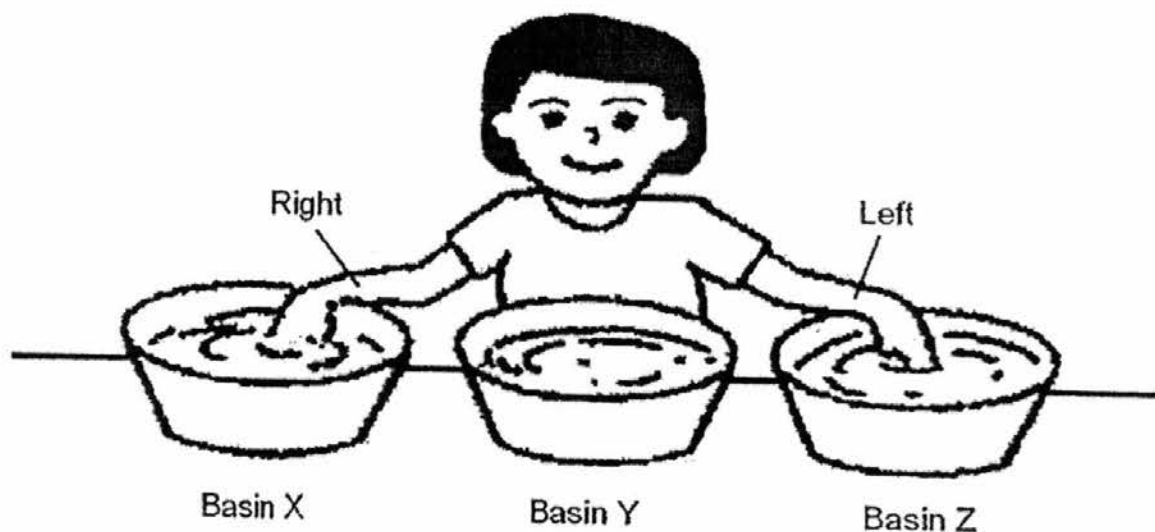

Two minutes later, she put both of her hands into Basin Y. She found that the water in Basin Y felt warm to her right hand but felt cold to her left hand.

Which one of the following shows the most likely temperature for water in the basins, X, Y and Z?

	X	Y	Z
1)	50°C	30°C	10°C
2)	10°C	50°C	30°C
3)	50°C	10°C	30°C
4)	10°C	30°C	50°C

18. Look at the classification table below.

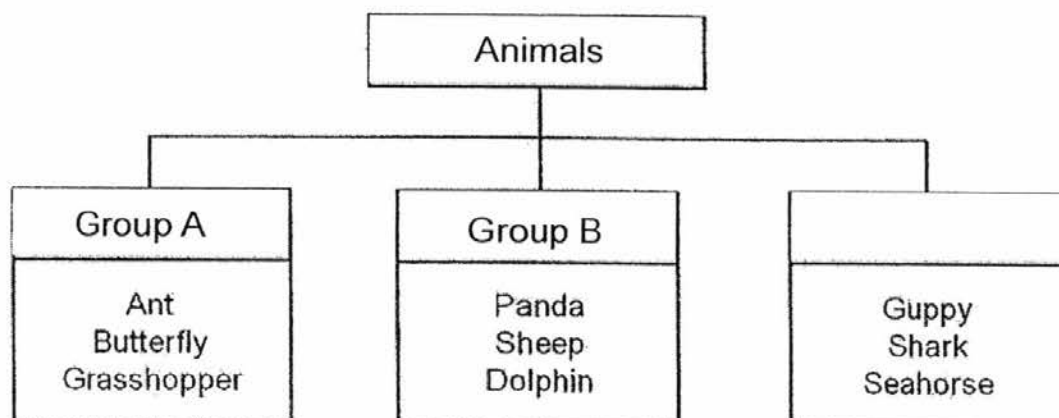

After studying the classification table, 4 pupils, Ali, Bethany, Chandra and Deborah, made the following statements.

Ali: Dolphin should be placed in Group C.

Bethany: The animals are grouped according to the different habitats they live in.

Chandra: The animals are grouped according to the different groups, insects, mammals and fish.

Deborah: The animals are grouped according to the types of food they eat.

Whose statement is correct?

- 1) Ali
- 2) Bethany

- 3) Chandra
- 4) Deborah

19 Which one of the following statements describes the difference between a seedling and an adult flowering plant?

- 1) An adult plant has roots but a seedling does not have roots.
- 2) An adult plant can respond to changes but a seedling cannot.
- 3) An adult plant needs water but a seedling does not need water.
- 4) An adult plant has flowers but a seedling does not have flowers.

20. When David breathed on the mirror, he noticed water droplets collecting on the mirror. After a short while, the water droplets disappeared.

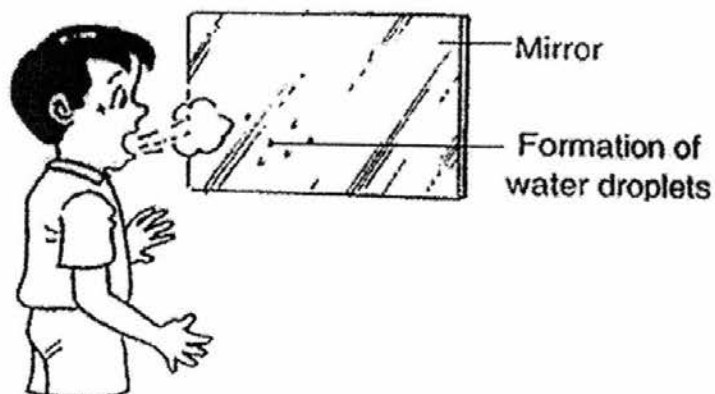

Where did the water droplets disappear to?

- 1) They were absorbed into the mirror.
- 2) They moved to the top of the mirror.
- 3) They returned back into David's mouth.
- 4) They evaporated into the surrounding air.

21. An experiment was conducted to find out how much light can pass through three different materials, A, B and C, using a light sensor connected to a datalogger. The table below shows the amount of light that passed through each material.

Materil	Amount of light (lux)
A	600
B	400
C	0

Based on the table above, which one of the following statements is **not** true?

- 1) Material C allows no light to pass through.
- 2) Material B allows less light to pass through than Material A.
- 3) When Material A and Material C are stacked together, no light can pass through them.
- 4) The total amount of light that can pass through Material A and Material B when they are stacked together is 1000 lux.

22. June wants to find the volume of a small piece of bamboo by using a measuring cylinder. She uses a stone to keep the bamboo under water. The results of each stage of his experiment are shown below.

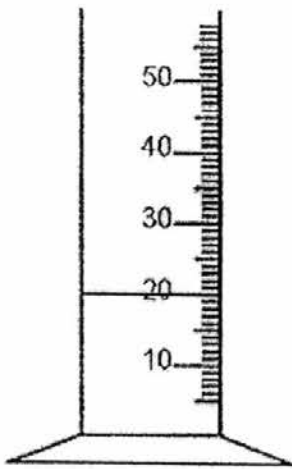

Water

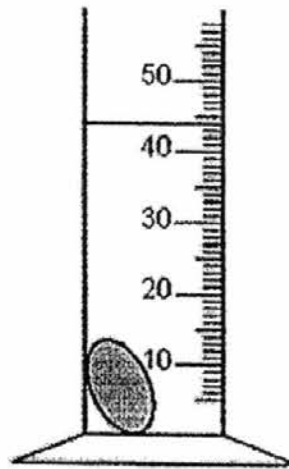

Water and stone

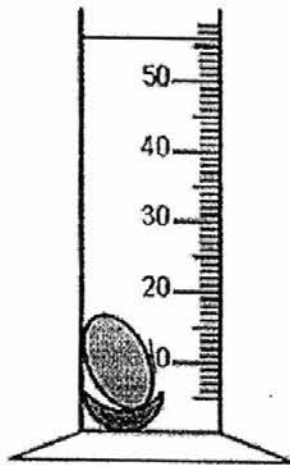

Water, bamboo
and stone

What are the volumes of the bamboo and the stone respectively?

	Volume of bamboo (cm ³)	Volume of stone (cm ³)
1)	3	22
2)	6	24
3)	11	30
4)	12	24

23. Tania placed a test tube of tap water into a beaker of ice as shown in the diagram below.

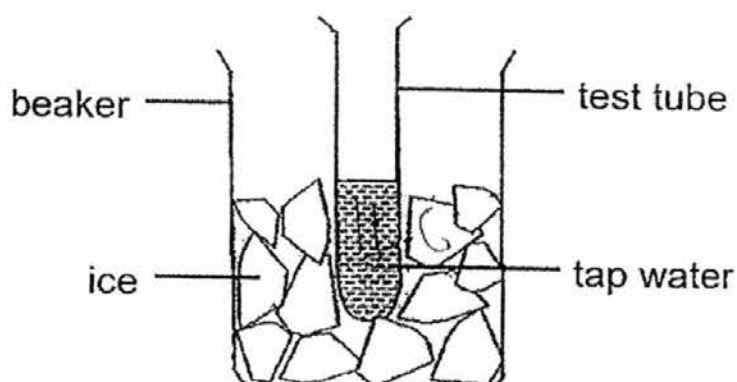

She used a thermometer to measure the temperature of tap water over a period of time. She then plotted a graph to show the change in the temperature of the water for 30 minutes.

Which one of the graphs below shows the change in the temperature of the tap water correctly?

1)

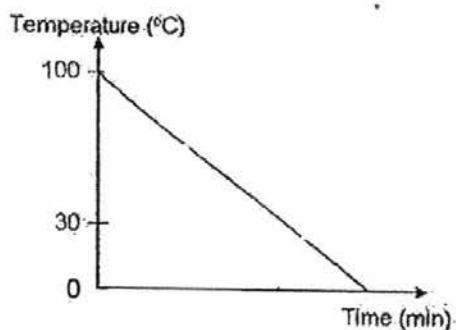

3)

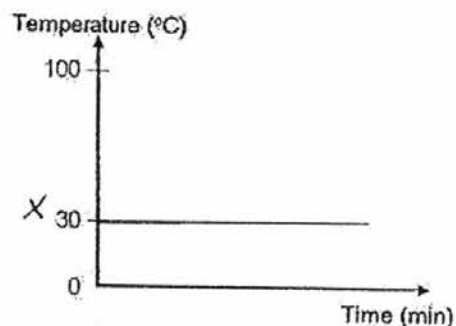

2)

X

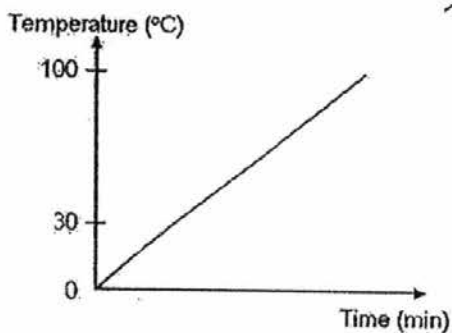

X (4)

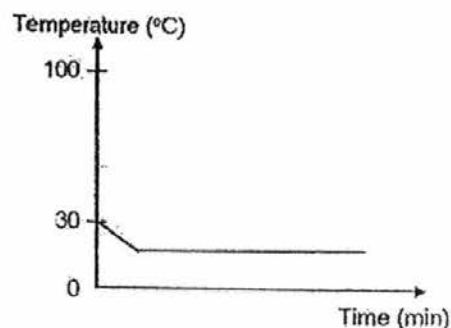

24. Two pieces of wood are glued together and placed between a torch and a screen as shown below.

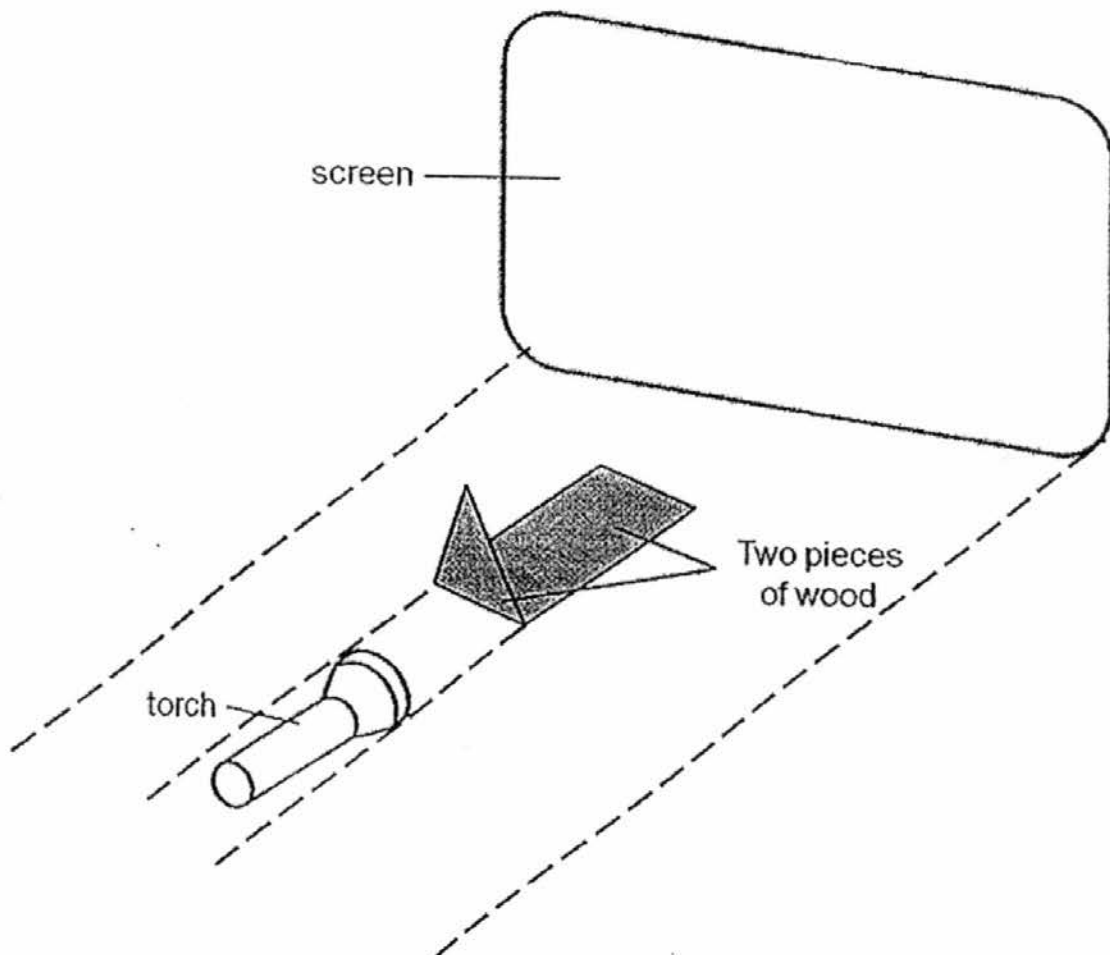

Which one of the following shadows will be formed on the screen?

1)



3)



2)



4)



25. Muthu filled up 4 identical beakers with different amounts of water at different temperatures. He then heated 4 identical blocks to a temperature of 70°C . After heating, he dropped each block into a beaker of water as shown in the diagrams below.

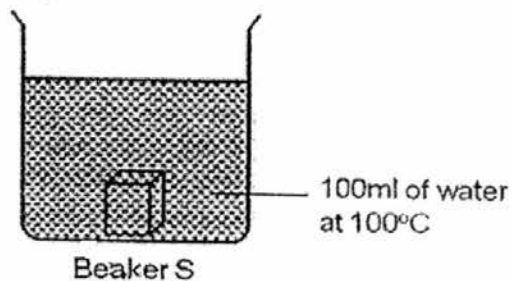
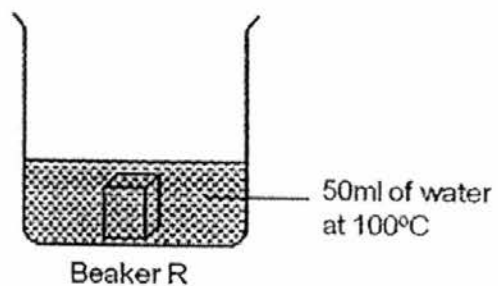
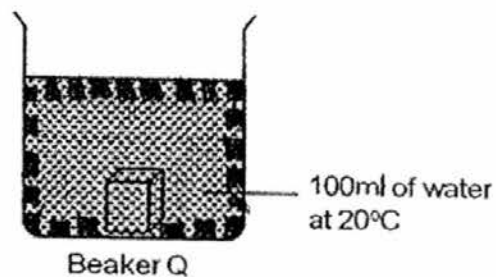
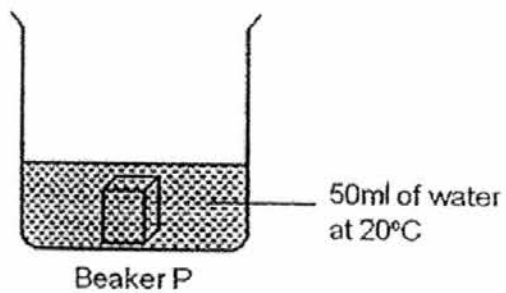

In which beaker would the water show the greatest rise in temperature?

- 1) P
- 2) Q
- 3) R
- 4) S

26. Aminah used a candle flame to heat up the side of an inverted flask as shown in the set-up below.

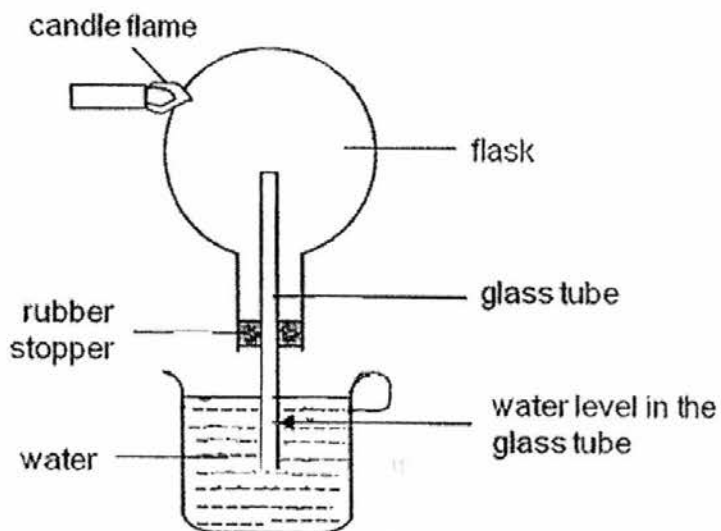

Aminah removed the candle flame and allowed the flask to cool. Which one of the following could be observed by Aminah after removing the candle?

- 1) Water level in the basin increased.
- 2) Water level in the glass tube increased.
- 3) More air bubbles were seen in the water.
- 4) A few large air bubbles entered the flask.

27. Study the flowchart below.

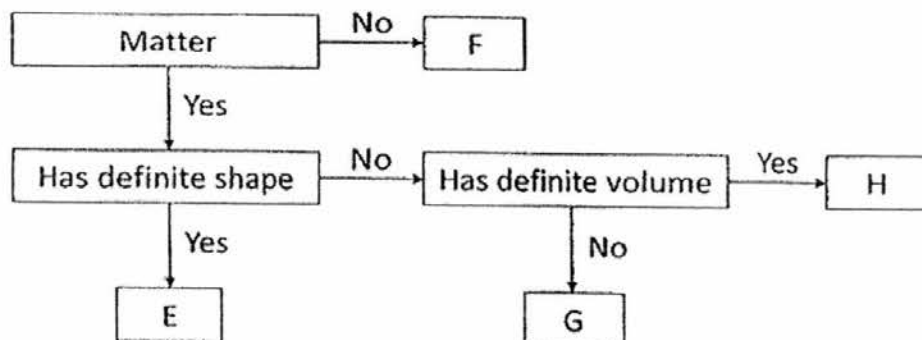

Which of the following best represents steam in the flowchart?

- 1) E
- 2) F
- 3) G
- 4) H

28. 20kg were hung from two ropes made from two different materials, A and B. Both have the same width. After half an hour, the rope made from Material B snapped while the rope made from Material A was still able to hold the box.

Rope made from Material A

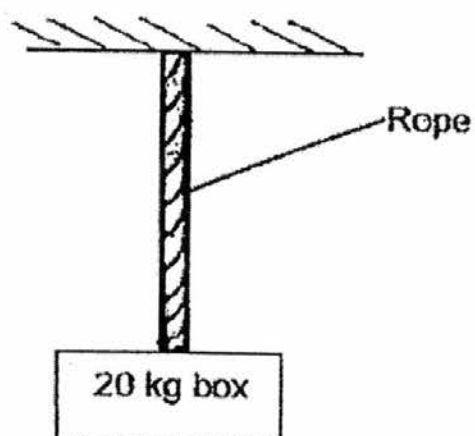

Rope made from Material B

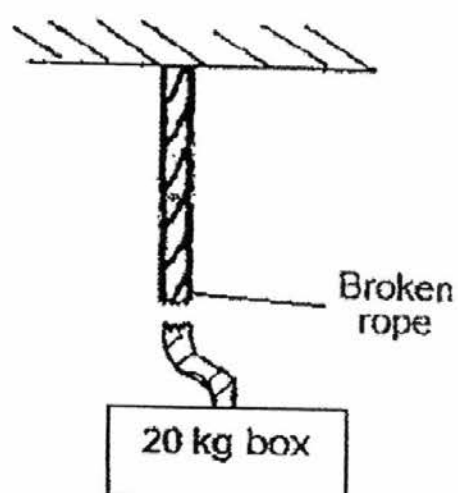

Based on the observation, which one of the following statements is correct?

- 1) Material A is harder than Material B.
- 2) Material A is thicker than Material B.
- 3) Material A is stronger than Material B.
- 4) Material A is more flexible than Material B.

End of Booklet A

SINGAPORE CHINESE GIRLS' SCHOOL (PRIMARY)

SECOND SEMESTRAL ASSESSMENT 2016

NAME: _____ ()

DATE: 21 October 2016

CLASS: PRIMARY 4 SY (C) / G / SE / P

Parent's Signature:

SCIENCE

BOOKLET B

	Total Actual Marks	Total Possible Marks
Booklet A		56
Booklet B		44
Total		100

14 questions

44 marks

Total time for Booklets A & B: 1 h 45 min

DO NOT OPEN THIS BOOKLET UNTIL YOU ARE TOLD TO DO SO.

FOLLOW ALL INSTRUCTIONS CAREFULLY.

Part II (44 marks)

Answer all the following questions.

29. The diagram below shows a boat.

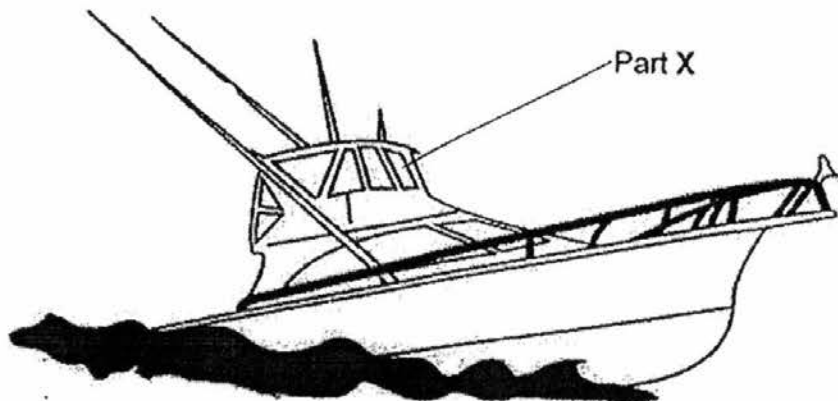

a) Part X is made of clear glass because it allows _____ to pass through so that the sailor can see where he is going. [1]

b) Suggest another material that can be used to make Part X. [1]

c) Mr. Tan built Part Y using steel instead of glass. Explain why. [1]

30. Ali placed two ring magnets, A and B, through a holder as shown below.

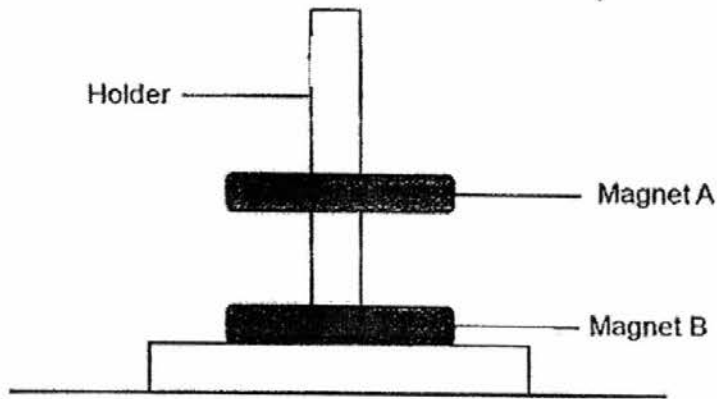

a) The holder was made of wood and did not attract the magnets.

Wood is a _____ material. [1]

b) Why was Magnet A floating above Magnet B?

Magnet B was _____ magnet A. [1]

c) Shi Hui stroked two similar iron rods, J and K, with the same magnet as shown in the figure below.

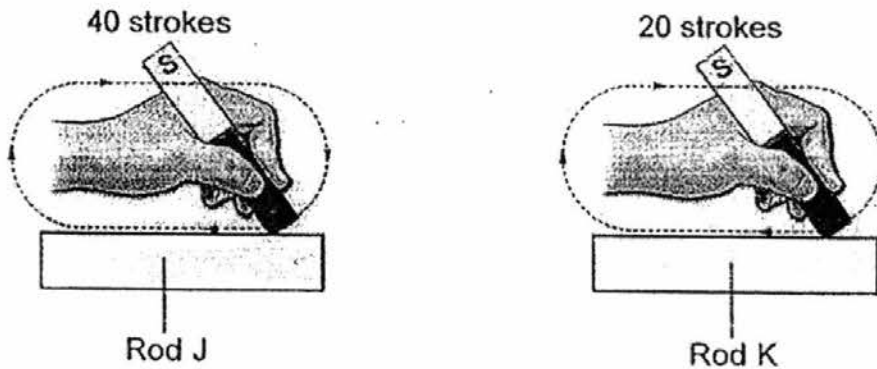

Both rods became magnets.

Tick the statement(s) that is/are correct. [1]

Statement	Tick if correct
Rod J attracted less pins than Rod K.	
Rod J attracted more pins than Rod K.	
Rod J attracted the same number of pins as Rod K.	

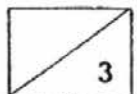

31. Lily shines a torch on a ball and a shadow is formed on a smooth wall.

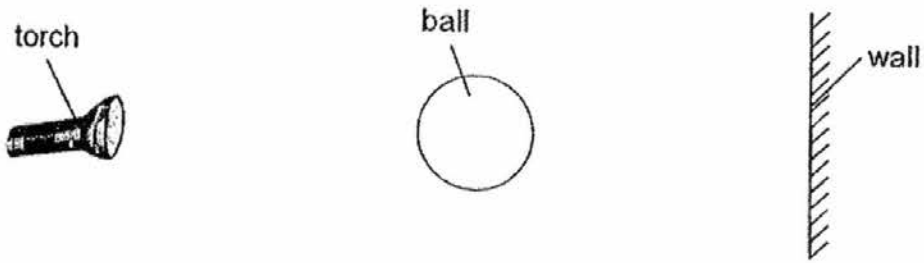

a) A shadow is formed when light is _____ by an object. [1]

b) Draw the shadow of the ball that is formed on the wall. [1]

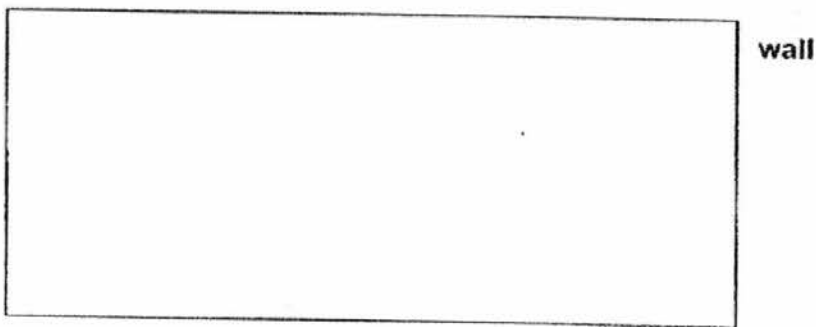

c) Look at the pictures. Tick the source(s) of light. [2]

mirror

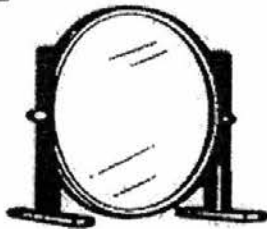

lightning



star in the sky



eyes

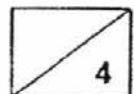

32. Choose the correct words from the box to fill in the blanks below.

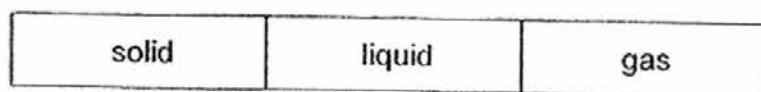

a) Benny pours honey from a bottle onto a table as shown below

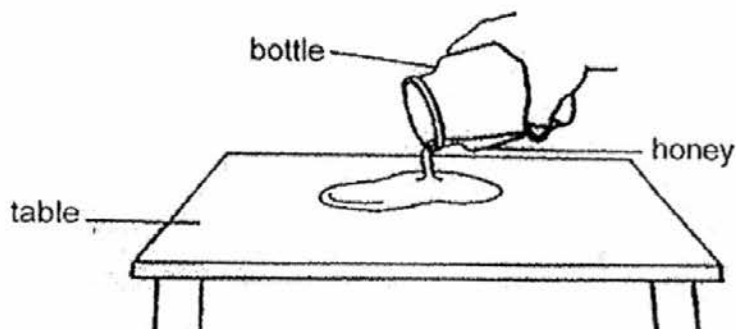

The volume of the honey remains the same but its shape changes.

This shows that honey is a _____

[1]

b) Benny pours some marbles from a bottle onto a table as shown below

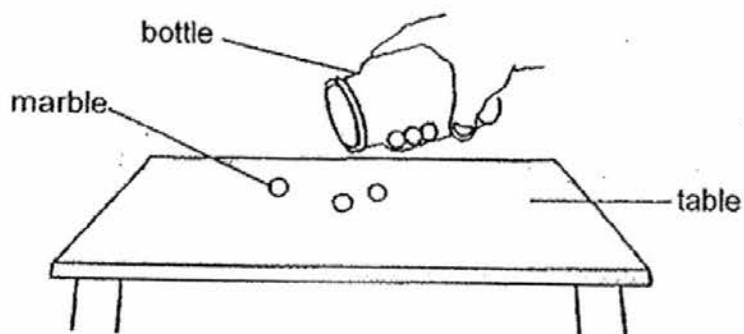

The shape and volume of the marbles remain the same.

This shows that a marble is a _____

[1]

33. Ah Ming carried out an experiment set-up as shown below.

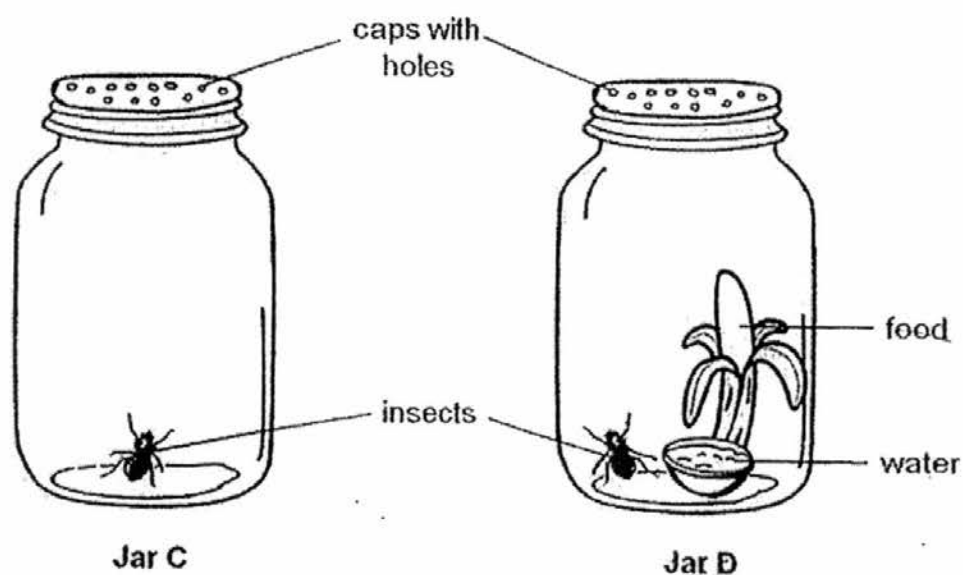

a) What would happen to the insect in each jar after several days? [1]

Jar C: _____

Jar D: _____

b) What conclusion can Ah Ming draw from this experiment? [1]

34. Three mugs, A, B and C, and a basin of water were used in an experiment. Three identical rings were attached to the bottom of the mugs. A hole was only made in Mugs B and C. Then, the 3 mugs were pushed into the water in the positions as shown in the diagram below.

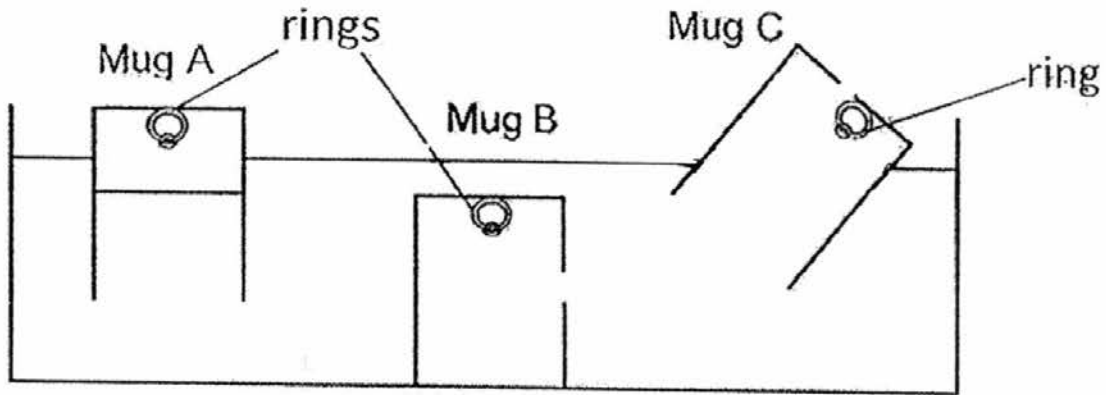

- a) In the diagram above, draw the water level in Mug C. [1]
- b) The ring in Mug B became wet. Explain how this happened. [2]

35. The table below shows the duration of each stage in the life cycle of Insect S.

Stage	Days
Egg	5
Nymph	12
Adult Male	8
Adult Female	9

a) How many stages are there in the life cycle of Insect S? [1]

b) How many days would Insect S take to become an adult after the egg is hatched? [1]

c) The adults do not take care of their young. Why do the adult female live longer than the adult male? [1]

36. Group the different body parts into the chart below.

[3]

lungs	mouth	blood vessels
gullet	heart	windpipe

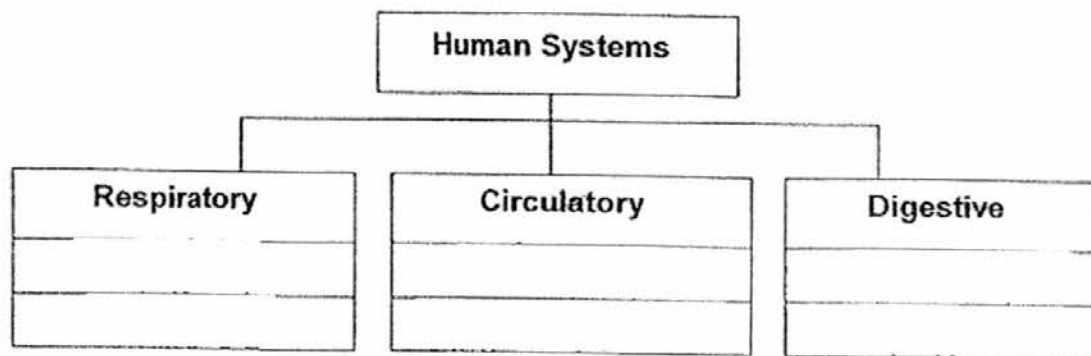

37. Shi Xuan wanted to investigate if the size of the shadow of Shawn's head will be affected when he sat at different distances away from the lamp.



- a) Shi Xuan traced the shadows and recorded her results in the following table.
Write 'T' for every true statement and 'F' for every false statement. [2]

Results	T / F
When Shawn moved closer to the paper, the size of the shadow became smaller.	
When Shawn moved closer to the spot light, the size of the shadow remained unchanged.	
When the spot light was moved closer to Shawn, his shadow became bigger.	
When the spot light was moved further away from Shawn, his shadow became bigger.	

37b) Study the diagram below.

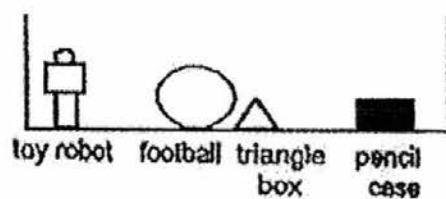
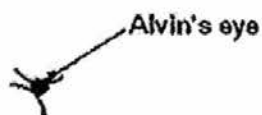

Some objects are placed in a box. Alvin looks into the box from a distance.

i) Which object(s) can Alvin see clearly? [1]

ii) What property of light prevents him from seeing the other things? [1]

38. A stone was hung outdoors on a steel wire that was tied to 2 wooden poles as shown in the following diagram. The temperature ranged from 19°C to 40°C at different times of the day.

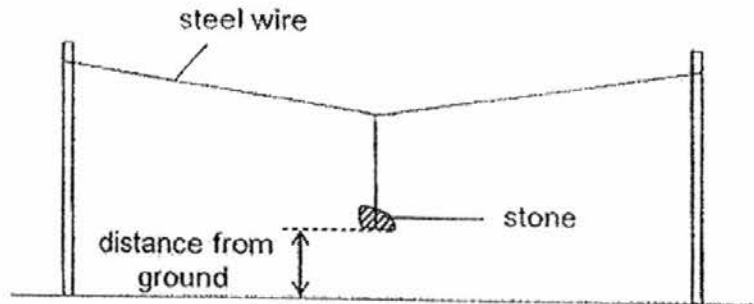

The following table shows the stone's distance from the ground at different temperatures during the day.

Temperature (°C)	19	23	29	40
Distance from ground (cm)	29.0	28.5	28.0	20.5

- a) Circle the likely distance of the stone from the ground if the temperature is 45°C.

19 cm	25.5 cm	32 cm	[1]
-------	---------	-------	-----

- b) Explain why the stone was closest to the ground at the highest temperature of the day [2]

- c) If the stone is replaced by a plastic weight of equal mass, what is the most likely distance from the ground when the temperature is 23°C? [1]

39. The table below charts the growth of a green bean seed.

Number of days	0	1	2	3	4	5	6	7
Mass of seed leaves (mg)	10	8	5.8	?	4	3.7	2	1

a) What is the mass of seed leaves on Day 3? [1]

b) Explain why the mass of the seed leaves decreased. [1]

c) Why do you think the plant can survive without any seed leaves after Day 8? [1]

40. David prepares the following set-ups to 'make' rain. Study them carefully.

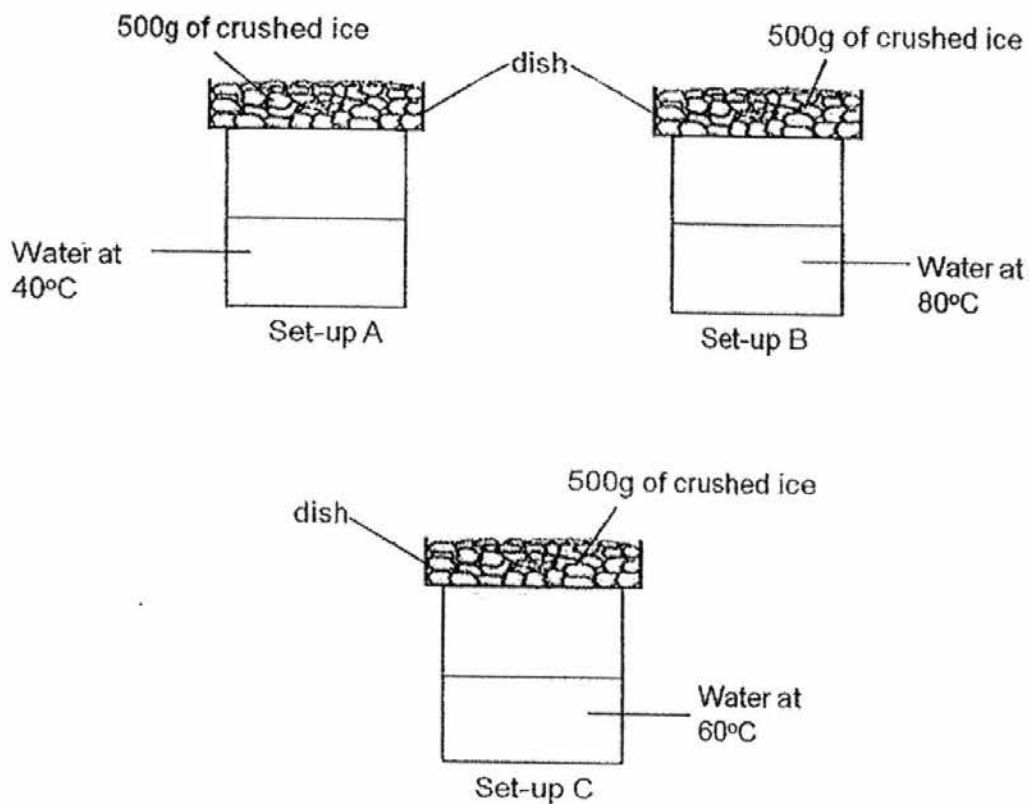

In which of the above set-ups will most water droplets be found on the underside of the dish? Give a reason to for your answer. [2]

41. Jessy placed 3 similar blocks of ice in 3 similar containers made of different materials; A, B and C, for 30 minutes.

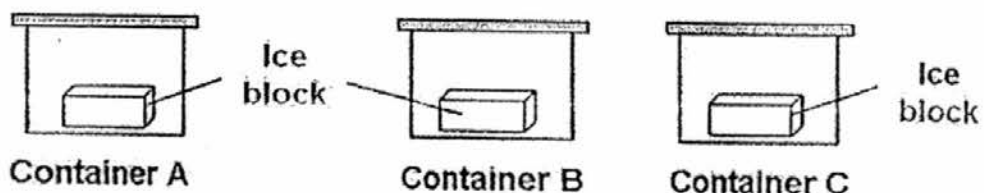

After 30 minutes, she took out the ice block from each container. She then measured the amount of water collected in each container and recorded her findings in the table below.

Container	Amount of water collected (cm^3)
A	65
B	36
C	103

- a) Which variable did Jessy change in this experiment? [1]

- b) If Jessy is going for a picnic, which container should she use if she wants to transport ice cream? Explain your answer. [2]

- c) If Jessy wants to heat up her soup on a stove in the shortest time, which container should she use? [1]

42. Ahmad conducted an experiment using two rods of the same size as shown in the diagram below. He recorded the time taken for the wax to melt.

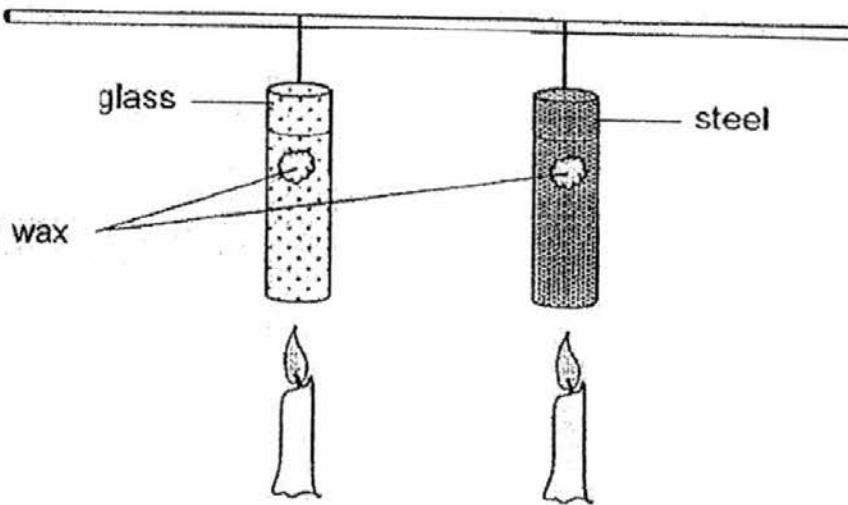

- a) State the likely aim of Ahmad's experiment. [2]

- b) Based on Ahmad's aim as stated in part (a), put a tick (✓) in the appropriate column to indicate which variables are to be changed, kept the same or used as results in his experiment. [2]

Variables	Changed	Used as results	Kept the same
Length of material			
Amount of wax used			
Time taken for wax to melt			
Distance between wax and flame			

~ End of Booklet ~

EXAM PAPER 2016 (P4)

SCHOOL : SCGS

SUBJECT : SCIENCE

TERM : SA2

Q1	Q2	Q3	Q4	Q5	Q6	Q7	Q8	Q9	Q10
3	2	3	3	1	2	2	2	1	1
Q11	Q12	Q13	Q14	Q15	Q16	Q17	Q18	Q19	Q20
3	3	1	4	2	3	4	3	4	4
Q21	Q22	Q23	Q24	Q25	Q26	Q27	Q28		
4	4	4	3	1	2	3	3		

Name: _____ Class: _____

SCGS SA2 PRIMARY 4 SCIENCE

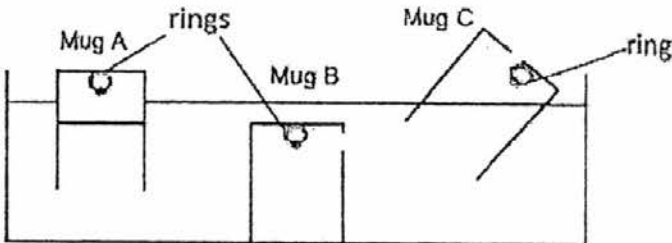
QN	Suggested Answers								
29a	light								
29b	clear plastic								
29c	Steel is stronger than glass.								
30a	non-magnetic								
30b	repelling								
30c	<table border="1" style="width: 100%; border-collapse: collapse;"> <thead> <tr> <th style="width: 80%;">Sentence</th> <th style="width: 20%;">Tick</th> </tr> </thead> <tbody> <tr> <td>Rod J attracted less pins than Rod K.</td> <td style="text-align: center;"><input type="checkbox"/></td> </tr> <tr> <td>Rod J attracted more pins than Rod K.</td> <td style="text-align: center;"><input checked="" type="checkbox"/></td> </tr> <tr> <td>Rod J attracted the same number of pins as Rod K.</td> <td style="text-align: center;"><input type="checkbox"/></td> </tr> </tbody> </table>	Sentence	Tick	Rod J attracted less pins than Rod K.	<input type="checkbox"/>	Rod J attracted more pins than Rod K.	<input checked="" type="checkbox"/>	Rod J attracted the same number of pins as Rod K.	<input type="checkbox"/>
Sentence	Tick								
Rod J attracted less pins than Rod K.	<input type="checkbox"/>								
Rod J attracted more pins than Rod K.	<input checked="" type="checkbox"/>								
Rod J attracted the same number of pins as Rod K.	<input type="checkbox"/>								
31a	blocked								
31b									
31c	lightning and star in sky								
32	a) liquid b) solid								
33a	Jar C: The insect will die. Jar D: The insect will still be alive.								
33b	The experiment shows that living things/ Insects need water and food to stay alive.								
34a									
34b	Air in mug B escaped through the hole so that water from the basin could then enter the mug to occupy the space.								
35a	3 stages								
35b	12 days								
35c	The adult female needs to lay eggs.								

QN	Suggested Answers																				
36	<ul style="list-style-type: none"> • Respiratory – Windpipe and lungs • Circulatory – Blood vessels and heart • Digestive – Mouth and gullet 																				
37a	<table border="1"> <tr> <td>1.</td> <td>True (T)</td> </tr> <tr> <td>2.</td> <td>False (F)</td> </tr> <tr> <td>3.</td> <td>True (T)</td> </tr> <tr> <td>4.</td> <td>False (F)</td> </tr> </table>	1.	True (T)	2.	False (F)	3.	True (T)	4.	False (F)												
1.	True (T)																				
2.	False (F)																				
3.	True (T)																				
4.	False (F)																				
37b(i)	Football and pencil case																				
37b(ii)	Light travels in straight lines.																				
38a.	19 cm																				
38b.	On the hottest day, the steel wire gained the most heat and expanded the most. The steel wire became the longest so the stone was the closest to the ground.																				
38c.	28.5 cm																				
39a	Any mass between 4.1mg to 5.7mg																				
39b	The baby plant depends on the seed leaves for food and it used up the food in the seed leaves over time.																				
39c	The plant is able to make its own food as it has grown leaves.																				
40)	Set-up B has the greatest temperature difference between hotter water vapour and cooler underside of dish so water vapour will condense fastest into water droplets on the cooler surface.																				
41a	Material of container																				
41b	Container B. As B is the poorest conductor of heat so the heat from the surroundings will be lost to the ice cream in the container the slowest . Thus the ice cream will melt the slowest.																				
41c	Container C																				
42a	To find out which material, glass or steel, is a better/ poorer conductor of heat..																				
42b	<table border="1"> <thead> <tr> <th>Variables</th> <th>Changed</th> <th>Result</th> <th>Same</th> </tr> </thead> <tbody> <tr> <td>Length of material</td> <td></td> <td></td> <td>✓</td> </tr> <tr> <td>Amount of wax used</td> <td></td> <td></td> <td>✓</td> </tr> <tr> <td>Time taken for wax to melt</td> <td></td> <td>✓</td> <td></td> </tr> <tr> <td>Distance between wax and flame</td> <td></td> <td></td> <td>✓</td> </tr> </tbody> </table>	Variables	Changed	Result	Same	Length of material			✓	Amount of wax used			✓	Time taken for wax to melt		✓		Distance between wax and flame			✓
Variables	Changed	Result	Same																		
Length of material			✓																		
Amount of wax used			✓																		
Time taken for wax to melt		✓																			
Distance between wax and flame			✓																		